

Instruction Manual

CON 11 & CON 110

Handheld Conductivity/TDS/Temp/RS232C Meter



OAKION[®]

EUTECH
INSTRUMENTS

Technology Made Easy...

ISO 9001
CERTIFIED

68X361303
Rev. 2 - 01/04

Preface

This manual serves to explain the use of the CON 11/110 Conductivity/TDS handheld meters. It functions as a handy reference step by step guide to help you operate the meter. It is written to cover as many anticipated application of the CON 11/110 meters as possible. If there are doubts in the use of the meter, please do not hesitate to contact the nearest Authorised Distributor.

Eutech Instruments / Oakton Instruments cannot accept any responsibility for damage or malfunction of the meter caused by improper use of the instruments.

The information presented in this manual is subjected to change without notice as improvements are made, and does represent a commitment on the part of Eutech Instruments Pte Ltd / Oakton Instruments.

Copyright © 2003 All rights reserved.

Eutech Instruments Pte Ltd

Oakton Instruments

Rev 2 - 01/04

Table of Contents

1	INTRODUCTION	1
2	DISPLAY AND KEYPAD FUNCTIONS	2
2.1	DISPLAY	2
2.2	KEYPAD.....	3
3	PREPARATION	5
3.1	INSERTING THE BATTERIES	5
3.2	CONDUCTIVITY ELECTRODE INFORMATION.....	6
3.3	CONNECTING THE ELECTRODE TO THE METER	7
3.4	ATTACHING THE ELECTRODE HOLDER TO THE METER	8
3.4.1	Inserting the electrode into the electrode holder	8
3.5	CONNECTING THE AC/DC ADAPTER	9
3.6	CONNECTING THE RS232C CABLE (ONLY FOR CON 110)	9
3.6.1	RS232C Configuration.....	10
4	CALIBRATION	11
4.1	IMPORTANT INFORMATION ON METER CALIBRATION.....	11
4.2	PREPARING THE METER FOR CALIBRATION	12
4.3	TEMPERATURE CALIBRATION	13
4.4	SELECTION OF AUTOMATIC OR MANUAL CALIBRATION	14
4.5	AUTOMATIC CALIBRATION (FOR CONDUCTIVITY CALIBRATION ONLY)	15
4.6	MANUAL CALIBRATION (FOR CONDUCTIVITY & TDS CALIBRATION)	17
4.7	TDS CALIBRATION	18
4.7.1	Calibrating for TDS Using Conductivity Standards & adjusting TDS factor	18
4.7.2	Setting the TDS Conversion Factor.....	18
4.7.3	Calibrating for TDS using TDS standards	19
5	MEASUREMENT	20
5.1	AUTOMATIC TEMPERATURE COMPENSATION	20
5.2	MANUAL TEMPERATURE COMPENSATION	21
5.2.1	Setting the manual temperature compensation value.....	22
5.3	TAKING MEASUREMENTS	23
5.3.1	Taking measurements with READY indicator selected on	23
5.3.2	Taking measurements with the Auto HOLD feature selected on.....	23
5.4	USING MANUAL RANGING FUNCTION	24
5.4.1	Selecting manual range.....	24
5.5	HOLD FUNCTION	25
6	MEMORY FUNCTION	26
6.1	MEMORY INPUT	26
6.2	MEMORY RECALL.....	27
7	PRINT FUNCTION (FOR CON 110 ONLY)	28
7.1	USING CON 110 METER WITH PRINTER OR COMPUTER.....	28
7.2	SENDING DATA TO COMPUTER OR PRINTER	29
7.2.1	Printing Current Data Manually.....	30
7.2.2	Print Data on Timed Interval.....	30
7.2.3	Print Data from Stored Memory	32
8	ADVANCED SETUP FUNCTION	34
8.1	ADVANCED SETUP MODE OVERVIEW	36
8.2	P1.0: UNIT CONFIGURATION (COF).....	38
8.2.1	P1.1: Selection of READY and Auto HOLD function.....	38
8.2.2	P1.2: Selection of °C or °F	39
8.2.3	P1.3: Selection of Automatic or Manual Temperature Compensation.....	40
8.2.4	P1.4: Selection of TDS Conversion Factor	41

8.3	P2.0: VIEWING CALIBRATION DATA	42
8.4	P3.0 VIEWING ELECTRODE DATA	43
8.5	P4.0: AUTO OFF.....	44
8.6	P5.0: RESET TO FACTORY DEFAULTS	45
8.6.1	<i>P5.1: Calibration Reset.....</i>	45
8.6.2	<i>P5.2: User Reset.....</i>	46
8.7	P6.0: MEMORY CLEAR.....	47
8.8	P7.0: TEMPERATURE.....	48
8.8.1	<i>P7.1: Setting the temperature coefficient.....</i>	48
8.8.2	<i>P7.2: Setting the normalisation temperature</i>	49
8.9	P8.0: SELECTION OF CELL CONSTANT	50
8.10	P9.0: AUTOMATIC AND SINGLE POINT CALIBRATION	51
8.10.1	<i>P9.1: Selection of Automatic or Manual Calibration.....</i>	51
8.10.2	<i>P9.2: Selection of Single or Multi Point Calibration</i>	52
9	CYBERCOMM PORTABLE DAS (FOR CON 110 ONLY).....	53
9.1	SYSTEM REQUIREMENTS.....	53
9.2	LOADING CYBERCOMM PORTABLE DAS.....	53
9.3	RUNNING CYBERCOMM PORTABLE	59
9.3.1	<i>Buttons & Check-Box.....</i>	60
9.3.2	<i>Menu.....</i>	61
9.3.3	<i>Communication Settings.....</i>	62
9.4	CAPTURING AND PRINTING DATA INTO COMPUTER USING DATA ACQUISITION.....	63
9.5	TROUBLE-SHOOTING GUIDE	64
10	ELECTRODE CARE AND MAINTENANCE.....	65
11	ERROR MESSAGES.....	66
12	TROUBLE SHOOTING.....	67
13	LIST OF ACCESSORIES	68
13.1	REPLACEMENT METER AND METER ACCESSORIES.....	68
13.2	CALIBRATION SOLUTIONS	68
14	FACTORY DEFAULT SETTINGS	69
14.1	CON 11 FACTORY DEFAULT SETTING.....	69
14.2	CON 110 FACTORY DEFAULT SETTING.....	70
15	SPECIFICATIONS	71
16	CALIBRATION TIPS.....	73
17	CALCULATING TDS CONVERSION FACTORS.....	73
18	CALCULATING TEMPERATURE COEFFICIENTS	74
19	WARRANTY	75
20	RETURN OF ITEMS.....	75

1 INTRODUCTION

Thank you for selecting the CON 11/110 Conductivity/TDS handheld meter. These meters are microprocessor-based instruments and are designed to be handy, capable of allowing one-hand operation. Each has a large customised LCD for clear and easy reading. It also has user-friendly features, all of which are accessible through the splash-proof membrane keypad. It is a unique and intelligent instrument and has the capability to cater to the preferences of the discerning individual. You have one of the two models:

- CON 11 meter
- CON 110 meter

Your meter includes a conductivity electrode (ECCONSEN91W electrode constant K = 1.0) with built-in temperature sensor and batteries.

The basic model is the CON 11 which is capable of measuring Conductivity, TDS and Temperature.

The deluxe model is the CON 110 which measures the Conductivity, TDS and Temperature and has a RS232C port that allows the meter to be connected to a computer or a printer via a cable for transferring data.

For power requirements, you can either use the 4 AAA-sized batteries or an AC/DC power adapter (sold separately).

Please read this manual thoroughly before operating your meter.

2 DISPLAY AND KEYPAD FUNCTIONS

2.1 Display

The LCD has a primary and secondary display.

- The primary display shows the measured Conductivity/TDS values.
- The secondary display shows the measured temperature.

The display also shows error messages, keypad functions and program functions.

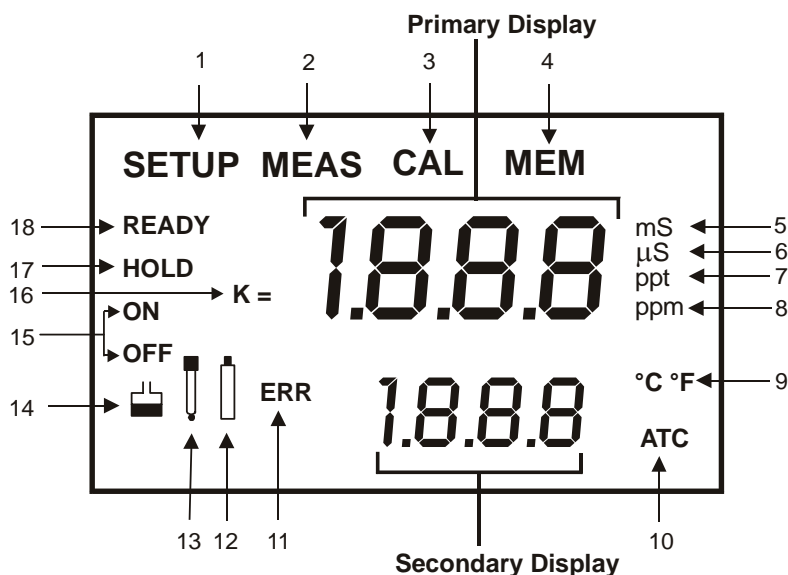













Figure 1: Active LCD display

1. SETUP - Setup mode indicator	7. ppt - Parts per thousand indicator	13.  - Electrode indicator
2. MEAS - Measurement mode indicator	8. ppm - Parts per million indicator	14.  - Calibration solution indicator
3. CAL - Calibration mode indicator	9. °C°F - Temperature indicator	15. ON – READY/Auto HOLD set up enable indicator. OFF – READY set up disable indicator
4. MEM - Memory recall mode indicator	10. ATC - Automatic Temperature Compensation indicator	16. K = - Cell Constant indicator.
5. ms - Mill siemens indicator	11. ERR - Error indicator	17. HOLD – Hold indicator
6. μs - Micro siemens indicator	12.  - Low battery indicator	18. READY – Ready indicator

2.2 Keypad

A large membrane keypad with tactile feedback makes the instruments easy to use (Figure 2). Each button, when pressed, has a corresponding graphic indicator on the LCD. Some button has several functions depending on its mode of operation.

KEY	FUNCTION
	<ul style="list-style-type: none"> ON/OFF - Powers on and shuts off the meter. The meter will start in the measurement mode it was in when last switched off.
	<ul style="list-style-type: none"> CAL - Activates the Conductivity or TDS calibration mode and when used with the MODE key, it activates the temperature calibration mode. MEAS - Allows return to measurement mode when canceling or terminating any operation.
	<ul style="list-style-type: none"> HOLD - Activates/Deactivates freezing of the measured reading while in measurement mode. ENTER - Confirms the calibration values in Calibration mode and the selection in SETUP and Print Function mode. Scroll through the memory location and the stored data during memory recall.
 	<ul style="list-style-type: none"> MI (Memory Input) - Captures the measured readings of the Conductivity or TDS with its corresponding temperature values and stores them in the memory. MR (Memory Recall) - Retrieves the stored data from memory. ▲▼ - Sets the calibration values during the manual Conductivity, TDS and Temperature calibration. Scrolls through each SETUP and its sub group menu. Scroll through Print Function menu and its parameters.
	<ul style="list-style-type: none"> SETUP- Activates the parameter setting menu to allow you to customise meter configuration, view calibration points and electrode offset data, select auto power off, reset meter, clear memory, set temperature coefficient and normalisation temperature, select electrode cell constants and set auto & single point calibration selections.
	<ul style="list-style-type: none"> MODE - Select the measurement parameter option between Conductivity and TDS. When used during Conductivity or TDS calibration mode, it activates the temperature calibration mode.
	<ul style="list-style-type: none"> RANGE – Allows entry to Manual range selection.
 (CON110 only)	<ul style="list-style-type: none"> PRINT - Allows transfer of current measurement or stored data to either the printer or the computer.

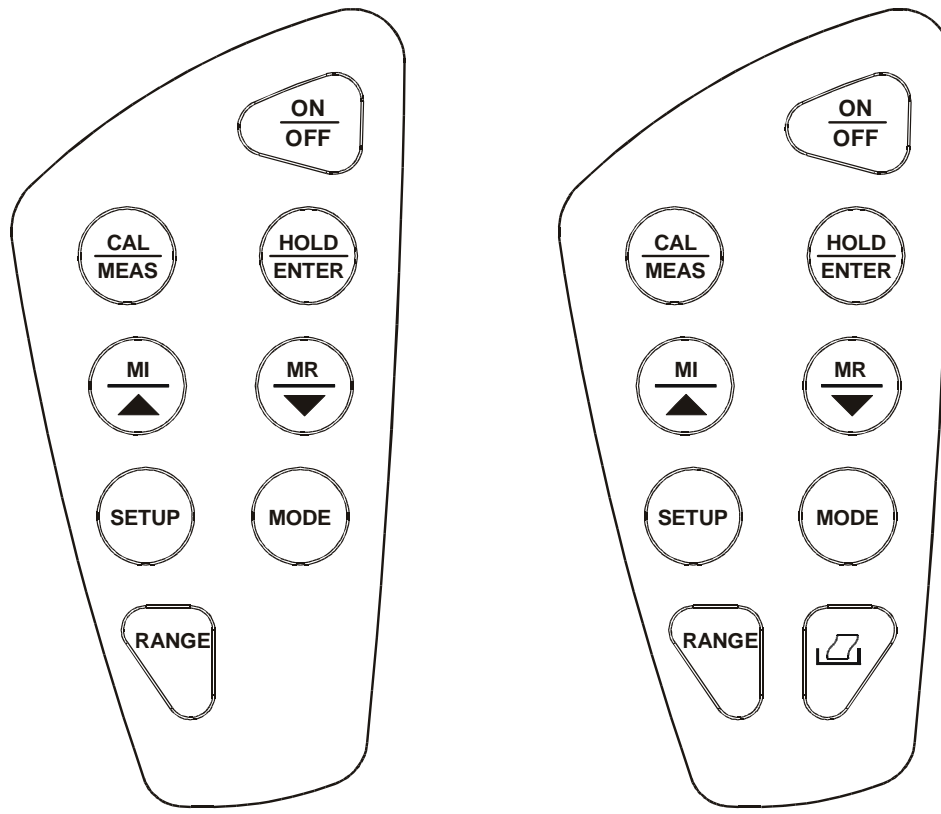

Keypad for CON 11 meter

Keypad for CON 110 meter

Figure 2: CON 11 and CON 110 keypads

3 PREPARATION

3.1 Inserting the Batteries

This meter is packaged with 4 “AAA” alkaline batteries required for its operation. To insert the batteries into the meter, follow the procedure outlined below.

1. Open the battery compartment by pressing down the catch of the battery cover.
2. Insert the batteries correctly according to the marked polarity of the battery compartment.
3. Close the battery cover, ensuring the catch is locked in position.

Your hand held meter is now ready for operation.

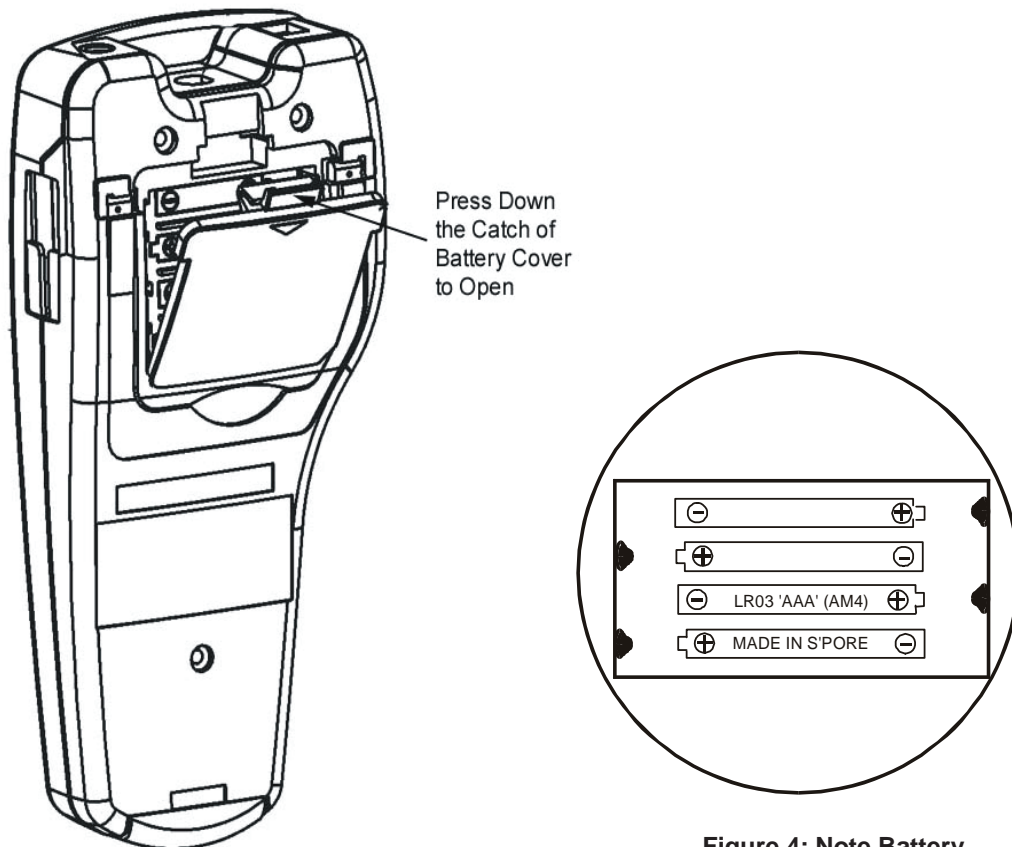

Figure 4: Note Battery Polarity

Figure 3: Open Battery Cover

3.2 Conductivity Electrode Information

Your meter includes a conductivity electrode (Part No: EC-CONSEN91W/ 35608-50) Ultem / Stainless Steel electrodes with an electrode constant of $K = 1.0$. This conductivity / TDS electrode features a built-in temperature sensor for Automatic Temperature Compensation (ATC). It has a specially designed housing that provides fast temperature response and reduces air bubble entrapment, which makes it easy to obtain accurate, stable readings.

Wetted parts include:

1. Polyetherimide PEI (Ultem®)
2. Polybutylene Terephthalate PBT (Valox®)
3. Stainless Steel (SS 304)

Proper use of electrode is essential to ensure that the optimum measurement is taken in a short time.

The removable protective plastic electrode guard is meant for simple periodic maintenance and it must be kept in tact during measurement and calibration.

Always immerse the electrode beyond upper steel band.

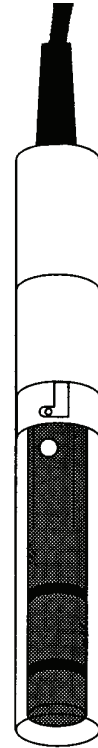

Figure 5: Conductivity Electrode (EC-CONSEN91W/ 35608-50)

NOTE:

1. DO NOT remove the protective electrode guard during measurement and calibration as it may affect your readings.
2. We recommend that you do not submerge the electrode above the protective yellow cap. You can submerge the cable for brief periods of time, but not continuously.

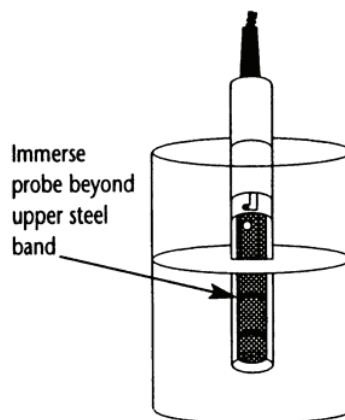

Figure 6: Electrode immersion level

3.3 Connecting the electrode to the meter

The CON 11 / 110 meter use the Conductivity / TDS electrode with a sturdy 6 pin connector which is easy to connect.

1. Insert the 6 pin female connector of the electrode to the 6 pins male connector on the meter. Rotate the locking ring clockwise until it locks.
2. To remove the electrode, simply rotate the connector's locking ring counterclockwise and pull away gently for a complete removal.

CAUTION: Do not pull on the electrode cord to avoid internal wire breakages.

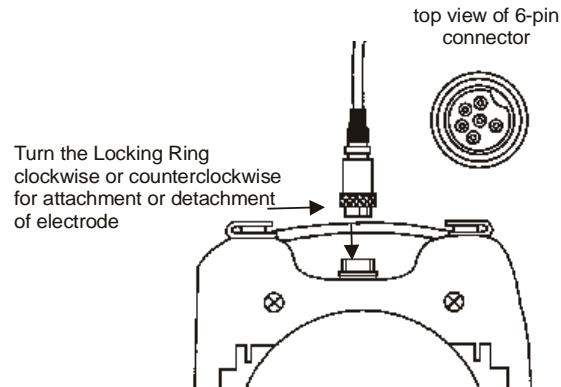

Figure 7: Turn the locking ring to lock into place

3.4 Attaching the Electrode Holder to the Meter

The CON meter is designed to allow you to do a one hand operation for any measurement or calibration. For that purpose, one electrode holder is provided. They are designed for easy use and installation. Care must be taken to avoid use of excessive force in the process of attaching this component.

1. Locate the slot on the right side of the meter.
2. Gently slide the flange of the holder into the slot of the meter. Make sure the holder is secured properly into the slot.
3. The design of the electrode holder allows you to attach it to the meter in different positions.

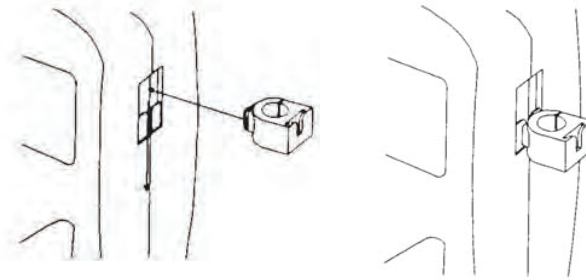

Figure 8: Insert electrode holder

3.4.1 Inserting the electrode into the electrode holder

The holder is designed for electrodes 16 mm in diameter. Electrodes larger than 16 mm may not fit in the holder. Forcing the electrode into the opening may damage the holder or your electrode.

1. Do not use excessive force when inserting electrode into the holder.
2. Insert the conductivity electrode into the opening of the holder until the top housing of the electrode touches the top of the holder.

The electrode holder can be attached in different positions for greater flexibility in measurement and storage purposes.

1. Slide the electrode holder out from the slot of the meter.
2. Reorient its position into appropriate orientation before putting back into the slot of the meter

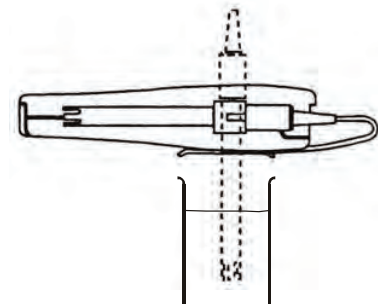

Figure 9: One hand operation

3.5 Connecting the AC/DC Adapter

Besides using the 4 “AAA” alkaline batteries as the power source, the CON 11/110 meter can also operate from the power mains using the AC/DC power adapter either at 120/220 VAC (sold separately) This is extremely useful if you have an AC power source available (e.g. laboratory)

Please ensure that the meter and the power source of the adapter are switched off before plugging in as a safety precaution that should be adhered to safeguard your meter.

1. Switch off the meter and power sources.
2. Select the correct AC/DC Adapter either at 120/220 VAC which matches your input mains voltage.
3. Select the correct output voltage of the AC/DC adapter. (Output Voltage: 9 to 15 V DC, Current: ≥ 50 mA).
4. Gently insert the power adapter D.C. jack into the meter power socket.
5. Switch on the power source of the adapter followed by the meter.

3.6 Connecting the RS232C Cable (Only for CON 110)

The CON 110 meter provides an RS232C output for you to transmit your readings either to a printer or a computer via a cable. This is useful in instances where the meter is used for continuous monitoring of a certain process or experiment. Data output to the printer or the computer can be then evaluated.

The output data is in the ASCII format. This format allows the data to be imported by a variety of software that reads ASCII data (e.g. Microsoft's Excel, Lotus, Quattro-pro etc.). A complimentary Data Acquisition Software (DAS) is provided and it captures data transmitted into an ASCII file for later use.

1. Gently detach the printer port cover located at the bottom end of the meter.
2. Plug the RS232C male connector into the RS232C port of the meter ensuring the correct orientation.
3. Secure the RS232C connector by fastening the two screws at the side of the male RS232C connector.

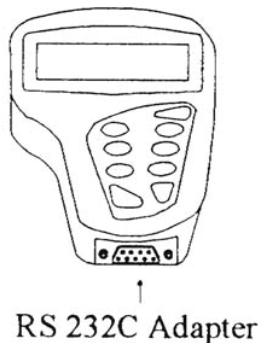

Figure 10: Location of RS232C

3.6.1 RS232C Configuration

The CON 110 meter has a 9 pin female RS232C connector with the following pin out.

PIN NO.	DESCRIPTION
1	-
2	Transmit Data
3	-
4	-
5	CTS (Clear to Send)
6	-
7	GND (Ground)
8	-
9	-

A one to one connection can be made with a 9 pin RS232C port of the computer.

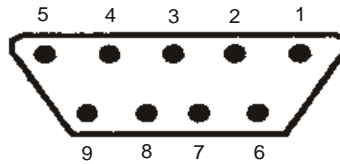

In case CON 110 meter's output has to be sent to a 25 pin RS232C connector, the following cable configuration may be used:

CON 110	25 pin connector
2 (TxD)	(RxD) 3
5 (CTS)	(RTS) 4
7 (GND)	(GND) 7

4 CALIBRATION

4.1 Important Information on Meter Calibration

Your meter has five measuring ranges. You have an option of calibrating your meter in a single point calibration for all the five ranges or for better accuracy; you can calibrate one point in each of the measuring ranges (up to five points). This selection of single point calibration and multi point calibration can be set in the SETUP menu Program P9.2. See page 52 .

The following table lists the corresponding conductivity and TDS ranges. For either the single or multi point calibration, you should calibrate using a solution that falls between the values in the “recommended calibration solution range” column.

Conductivity Range	Recommended Calibration Solution Range	TDS Range	Recommended Calibration Solution Range
0 to 19.99 $\mu\text{S/cm}$,	6.00 to 17.00 μS	0.00 to 9.99 ppm	3.00 to 8.50 ppm
20.0 to 199.9 $\mu\text{S/cm}$,	60.0 to 170.0 μS	10.0 to 99.9 ppm	30.0 to 85.0 ppm
200 to 1999 $\mu\text{S/cm}$;	600 to 1700 μS	100 to 999 ppm;	300 to 850 ppn
2.00 to 19.99 mS/cm,	6.00 to 17.00 mS	1.00 to 9.99 ppt	3.00 to 8.50 ppt
20.0 to 199.9 mS/cm	60.0 to 170.0 mS	10.0 to 99.9 ppt	30.0 to 170.0 ppt

Table 1: Recommended Calibration Solution Range in correspond to Conductivity / TDS

In single point calibration, when you recalibrate your meter, the old calibration will be replaced by the new one even if the new calibration is done in a different range from the old calibration. For example, if you have previously calibrated your conductivity meter at 1413 μS in 0 to 2000 μS range, and you recalibrate at 12.88 mS in 0 to 20.00 mS range, the new calibration will override the previous calibration in 0 to 2000 μS range.

In the case of multi point calibration, when you recalibrate your meter, old calibrations are replaced only on a range basis. For example, if you previously calibrated your conductivity meter at 1413 μS in 0 to 2000 μS range and you recalibrate at 1500 μS (also in 0 to 2000 μS range), the meter will replace only the old calibration data (1413 μS) in that range. The meter will retain all calibration data in other ranges.

To completely recalibrate your meter, or when you use a replacement electrode, it is best to clear all calibration data. See page 45 for more information on calibration data clearance.

4.2 Preparing the Meter for Calibration

Before starting calibration, make sure you are in the correct measurement mode.

For best results, select a standard value close to the sample value you are measuring. Alternatively use a calibration solution value that is approximately 2/3 the full-scale value of the measurement range you plan to use. For example, in the 0 to 2000 μS conductivity range, use a 1413 μS solution for calibration.

Perform calibration for all measurement ranges to ensure the highest accuracy throughout all measurement range. Note that CON 11/110 will not accept calibration values less than 2 $\mu\text{S}/\text{cm}$ (1.0 ppm).

If you are measuring in solutions with Conductivity lower than 100 $\mu\text{S}/\text{cm}$ or TDS lower than 50 ppm, calibrate the meter at least once a week to get good accuracy. If you are measuring in the mid ranges and you wash the electrode in deionised water and store it dry, calibrate the meter once a month. If you take measurements at extreme temperatures, calibrate at least once a week.

Ensure that you use new Conductivity standard solutions or sachets during calibration. Do not reuse standard solutions as it may be contaminated and affect the calibration and accuracy of measurements. Use fresh calibration solution each time you calibrate your meter. Keep solutions in a dry and cool environment if possible.

Always rinse the electrode with either tap water or rinse solution before and after each calibration/sample measurement to avoid cross-contamination.

NOTE: These meters are factory set to a temperature coefficient of 2.1% per °C. For most applications this will provide good results.

NOTE: The factory default value for normalisation temperature is 25 °C.

4.3 Temperature Calibration

Your electrode features a built-in temperature sensor. The temperature sensor is factory calibrated. Calibrate your sensor only if you suspect temperature errors may have occurred over a long period of time or if you have a replacement electrode.

1. Make sure the electrode is attached to the 6-pin connector. The ATC annunciator will appear at the bottom right-hand corner of the LCD.
2. Switch the meter on. Press the CAL/MEAS key to enter conductivity or TDS calibration mode. The CAL indicator appears above the primary display.
3. While in conductivity or TDS calibration mode, press the MODE key to enter temperature calibration mode. The primary display shows the current measured temperature reading based on the last set offset and the secondary display shows the current measured temperature reading based on factory default calibration.
4. Dip the electrode into a solution of known temperature (i.e. a temperature bath). Allow time for the built-in temperature sensor to stabilise.
5. Scroll with the MI/▲ or MR/▼ keys to set the correct temperature value (i.e. the temperature of the temperature bath). You can adjust the reading in increments of 0.1 °C.
6. Once you have selected the correct temperature, press the HOLD/ENTER key to confirm. The meter will be calibrated and return to the measurement mode.

NOTES:

- To exit this program without confirming the temperature calibration value, DO NOT press HOLD/ENTER. Press CAL/MEAS instead.
- If the ATC indicator does not light up, see SETUP menu Program P1.3 to switch it on. See page 40.
- Since temperature readings affect the accuracy of conductivity / TDS measurements, it is strongly recommended to carry out a conductivity / TDS calibration after a temperature calibration is done.

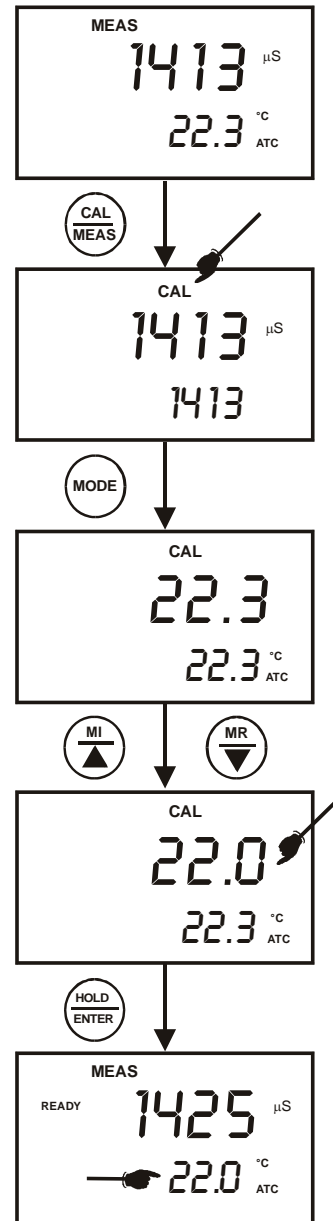

Figure 11: Temperature Calibration

4.4 Selection of Automatic or Manual Calibration

This meter is capable of performing either automatic conductivity calibration or manual conductivity / TDS calibration.

In the automatic calibration mode, the meter automatically detects and verifies the appropriate *known calibration standards solutions* before accepting these particular calibration standards as one of its calibration values in a specific measurement range. This automatic calibration mode frees you from cumbersome calibration procedure.

The *known calibration standards* used for automatic calibration are:

Meter	Temperature Normalisation (tnr °C)	Calibration Standards (Range)
CON 11/110	25.0 °C	84 µS (for 0 – 200 µS/cm) 1413 µS (for 0 – 2000 µS/cm) 12.88 mS (for 0.00 – 20.00 mS/cm) 111.8 mS (for 0.0 – 200.0 mS/cm)
	20.0 °C	76 µS (for 0 – 200 µS/cm) 1278 µS (for 0 – 2000 µS/cm) 11.67 mS (for 0.00 – 20.00 mS/cm) 102.1 mS (for 0.0 – 200.0 mS/cm)

Table 2: Conductivity Calibration Standards for Auto calibrations

In the manual calibration, non-standard calibration values can be used for calibration. You can manually input the appropriate values as your desired calibration standards in each specific range. This is useful when you have a customised calibration standard specifically unique for your application.

4.5 Automatic Calibration (For Conductivity Calibration Only)

In the Automatic Calibration mode, the meter is capable of accepting either single-point or up to 4 points for multi-point calibration with maximum of 1 point per specific measurement range. Set up the automatic calibration mode in the SETUP menu Program P9.1 by setting to “YES”. See page 51 for the set up procedure.

The following procedure describes the method for a single point calibration to a 1413 μS conductivity calibration standard. Set the single point calibration mode to on in the SETUP menu Program 9.2 by setting to ‘YES’. See page 52 for the single point calibration set up procedure.

1. If necessary, press the MODE key to select conductivity mode.
2. Rinse the electrode thoroughly with de-ionised water or a rinse solution, and then rinse with a small amount of calibration standard.
3. Dip the electrode into the calibration standard. Immerse the electrode tip beyond the upper steel band. Stir the electrode gently to create a homogeneous sample. Allow time for the reading to stabilise.
4. Press CAL/MEAS to enter conductivity calibration mode. The CAL indicator will appear in the upper corner of the display. The current measured value will be displayed in the primary display whereas the value of the calibration standard will appear in the secondary display.
5. Press the HOLD/ENTER to confirm the calibration value. The meter returns automatically to the measurement mode with the new calibrated value.

This single point calibration will apply to all the five ranges.

As for multi point calibration, set up the multi point calibration mode in the SETUP menu Program P9.2 by setting to ‘NO’.

Repeat step 1 to 5 for every calibration point in each measuring ranges using the known calibration solutions until all points have been calibrated if necessary.

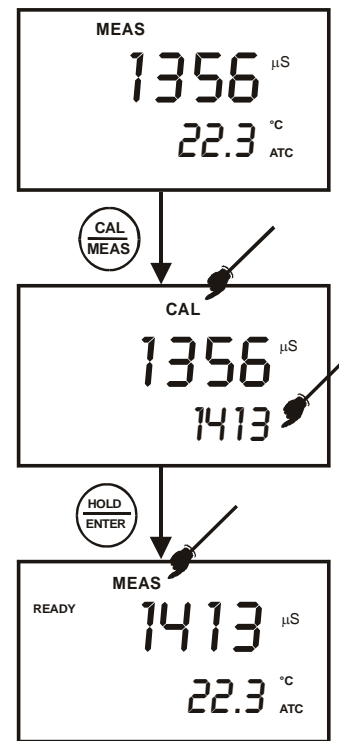

Figure 12: Automatic Conductivity Calibration

IMPORTANT NOTES:

1. Meter allows a tolerance range of $\pm 40\%$ of its calibration standard. If the calibration standard is detected out of the tolerance range during the calibration mode, the meter will prompt by the toggling of the secondary display continuously between various calibration standard values. An error message "**ERR**" will be displayed for 3 seconds if you attempt to calibrate with a solution whose value is outside the tolerance range.
For instance: For 1413 μS conductivity calibration standard, 40% tolerance is from 848 μS to 1978 μS .
2. All new calibration data will over-ride existing stored calibration data for each measuring range calibrated.
3. It is important to use new conductivity calibration standards.
4. Low conductivity standard solution (less than 20 $\mu\text{S}/\text{cm}$) cannot be available easily. Such low conductivity standard will be contaminated as soon as it is exposed to the air. It is therefore for this reason automatic calibration in the first measurement range (0.00 to 20.0 $\mu\text{S}/\text{cm}$) of this meter is not possible.

4.6 Manual Calibration (For Conductivity & TDS Calibration)

In Manual Calibration mode, you can use customised Conductivity / TDS calibration standards (specific to your own application) and calibrate the meter. The following example shows the calibration sequence to 12.00 mS conductivity calibration standard. Set up the manual calibration mode in the SETUP menu Program P9.1 by setting to “NO”. See page 51.

The following procedure describes the method for a single point calibration. Set the single point calibration mode to on in the SETUP menu Program 9.2 by setting to “YES”. See page 52 for the single point calibration set up procedure.

1. If necessary, press the MODE key to select conductivity mode.
2. Rinse the electrode thoroughly with de-ionised water or a rinse solution, and then rinse with a small amount of calibration standard.
3. Dip the electrode into the calibration standard. Immerse the electrode tip beyond the upper steel band (see Figure 6 in page 6). Stir the electrode gently to create a homogeneous sample. Allow time for the reading to stabilise.
4. Press CAL/MEAS key to enter conductivity calibration mode. The CAL indicator will appear in the upper corner of the display. The upper (primary) display shows the measured value which is with respect to the last calibration while the lower (secondary) display shows the measured value with respect to the default calibration.

NOTE: To exit calibration without confirmation, press CAL/MEAS key again to go back to measurement mode.

5. Wait for the value to stabilise and press MI/▲ or MR/▼ key and adjust the value in the upper display to the calibration standard used.
6. Press the HOLD/ENTER key to confirm. The meter returns to measurement mode with the new calibrated value.

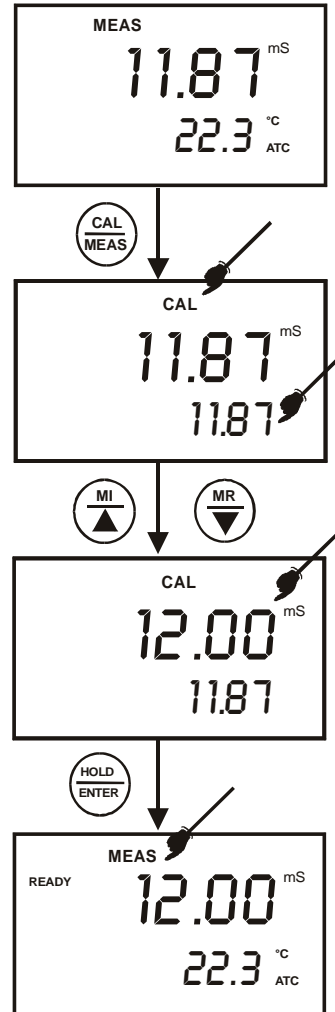

Figure13: Manual Calibration

This single point calibration will apply to all the five ranges.

As for multi point calibration, set up the multi point calibration mode in the SETUP menu Program P9.2 by setting to ‘NO’.

Repeat step 1 to 6 for every calibration point (one in each measuring range) using the desired calibration solutions until all points have been calibrated.

4.7 TDS Calibration

4.7.1 Calibrating for TDS Using Conductivity Standards & adjusting TDS factor

It is important to note that the increase in concentration of salts dissolved in solution increases the conductivity of that solution. This relationship varies from salt to salt and is roughly linear over a given range for a given salt. The TDS conversion factor is the number used by the meter to convert from conductivity to TDS.

Instead of calibrating for TDS directly using TDS calibration standard solutions, you can have TDS calibration by using the conductivity calibration method and enter the appropriate TDS conversion factor into the meter.

For more information regarding TDS Conversion Factor determination, please refer to page 73.

4.7.2 Setting the TDS Conversion Factor

The factory default setting for TDS conversion factor is 0.5. If your solution has a different TDS factor, you can improve calibration accuracy by setting the TDS factor prior to calibration.

1. Press MODE key to select TDS mode.
2. Press Setup key to enter SETUP Menu.
3. Press the HOLD/ENTER key a few times to scroll through the sub programs until you view Program P1.4
4. Press the HOLD/ENTER key again. The upper display shows a value and the lower display shows "tdS".
5. Press the MI/▲ or MR/▼ keys to select your calculated TDS conversion factor.
6. Press the HOLD/ENTER key to confirm selection and to return to the subgroup menu.
7. Press the CAL/MEAS key to return to measurement mode.

NOTE: The set up program P1.4 for setting the TDS conversion factor is only activated when set up menu is entered while the meter is in the TDS measurement mode.

Only from TDS Measurement Mode

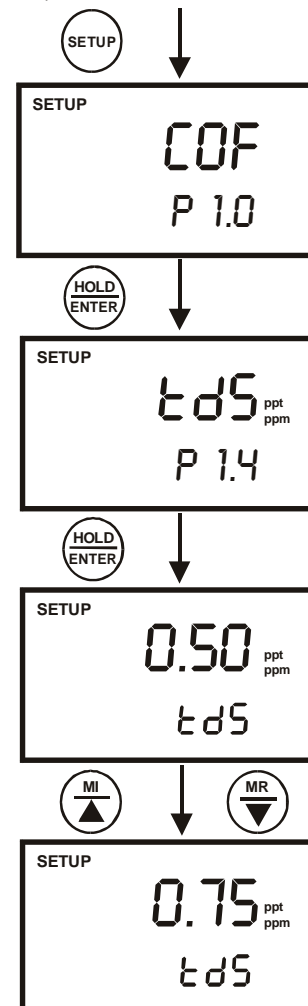

Figure 14: Setting the TDS Conversion Factor

4.7.3 Calibrating for TDS using TDS standards

After setting the correct TDS Factor, you can commence calibration in the TDS mode.

From the measurement mode,

1. If necessary, press the MODE key to select the TDS mode.
2. For the rest of the calibration process, repeat the similar step 2 to 6 as in the section of Manual Calibration on page 17, this time using the TDS calibration standards.

NOTE: You can offset the TDS reading up to $\pm 40\%$ from the default setting. If your measured value differs by more than $\pm 40\%$, clean or replace electrode as needed.

5 MEASUREMENT

This meter is capable of taking measurements with automatic (ATC) or manual (MTC) temperature compensation. Factory default is ATC on.

5.1 Automatic Temperature Compensation

For automatic temperature compensation (ATC), simply attach the conductivity/TDS electrode to the meter. Ensure that the ATC mode has been selected in the SETUP menu. The ATC indicator will light on the LCD.

NOTE: If the conductivity/TDS electrode is not properly attached to the meter or it has been damaged, the ATC indicator will blink and the temperature display will show "Ur".

If the ATC indicator does not light and the temperature display shows a reading, ATC mode may have been replaced with the manual temperature compensation mode in the meter's SETUP menu. See page 21 Section 5.2 on Manual Temperature Compensation.

Automatic Temperature Compensation mode can be restored by setting the SETUP Menu Program P1.3 to YES.



Figure 15: Automatic Temperature Compensation

5.2 Manual Temperature Compensation

To select the Manual Temperature Compensation (MTC) option, set up the Manual Temperature Compensation mode in the SETUP menu Program P 1.3 by setting to 'NO'.

1. Press SETUP key to enter Set Up mode. The display shows "COF" at "P 1.0".
2. Press the HOLD/ENTER key to scroll through subgroups until you view "ATC" at "P1.3" with small annunciators of "°C" and "ATC" or "°F" and "ATC".
3. Press the HOLD/ENTER key again. The upper display shows "ATC" and the lower display shows "YES".
4. Press the MI/▲ or MR/▼ key to select the lower display to show "NO".
5. Press the HOLD/ENTER key to confirm selection and to return to the subgroup menu.
6. Press the CAL/MEAS key to return to measurement mode.

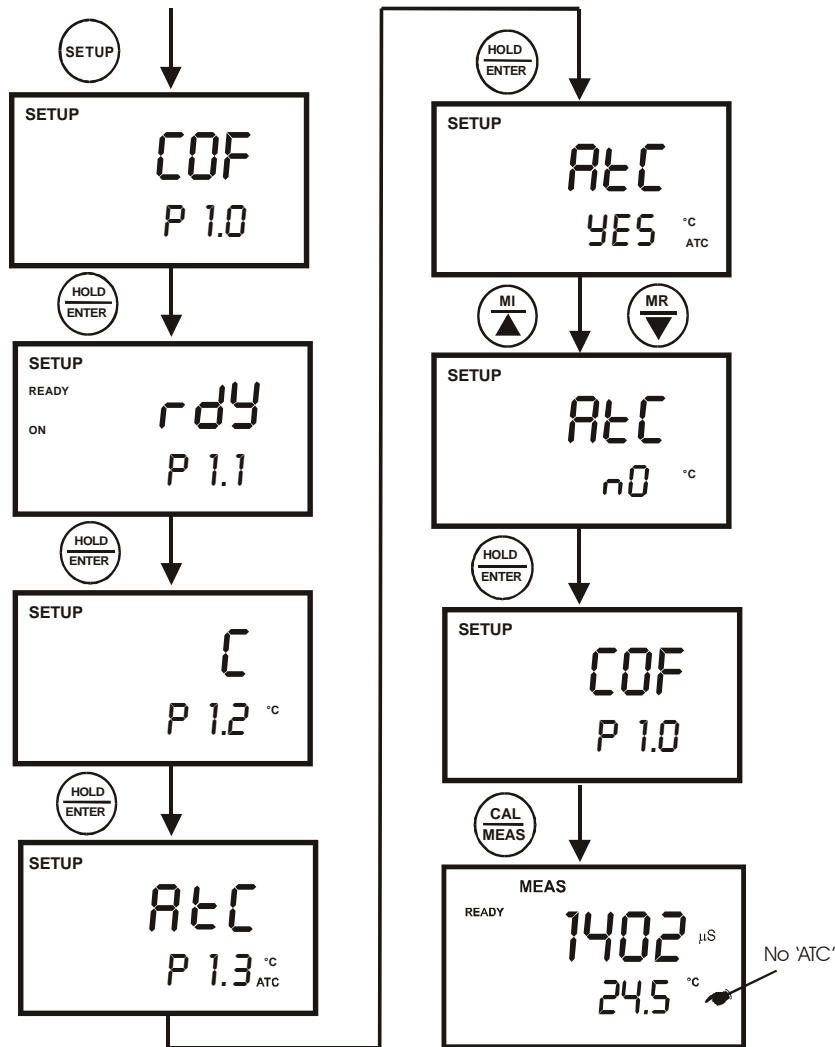

Figure 16: Manual Temperature Compensation Set Up sequence

5.2.1 Setting the manual temperature compensation value

To use manual temperature compensation (MTC), you need to enter the temperature value of your sample into the meter. This is the temperature value at which the measured readings will be manually temperature compensated. You can select any temperature between -10.0 to 110.0 °C (14.0 to 230 °F). Default value is 25 °C.

1. Switch the meter on. If necessary, set up the MTC by selecting ATC off as described in page 21. The ATC indicator will not appear on the display.
2. Press the CAL/MEAS key to enter conductivity or TDS calibration mode. The CAL indicator will appear above the primary display.
3. While in conductivity or TDS calibration mode, press the MODE key to enter temperature calibration mode. The primary display act as the adjustable temperature setting and the secondary display shows the default temperature value of 25 °C or indicates the last set temperature setting. Check the temperature of your sample using an accurate thermometer.
4. Press the MI/▲ or MR/▼ keys to offset the temperature to the measured value from step 3.
5. Press HOLD/ENTER to confirm the selected temperature and to return to the Conductivity or TDS measurement mode.

The meter will now compensate Conductivity or TDS readings for manually set temperature.

NOTES:

To exit this program without confirming the manual temperature compensation value, DO NOT press HOLD/ENTER in step 5. Press CAL/MEAS instead.

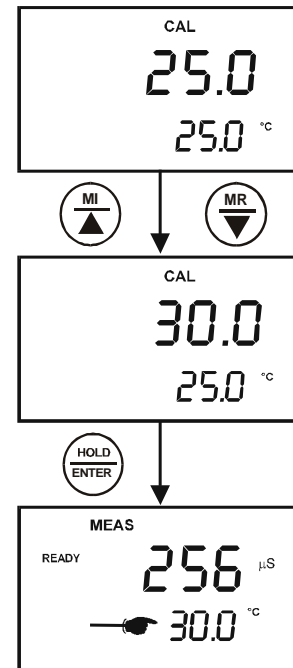

Figure 17: Select Manual Temperature Compensation Value

5.3 Taking Measurements

1. Rinse the electrode with de-ionised or distilled water before use to remove any impurities adhering to the electrode body. Shake or air dry. To avoid contamination or dilution of your sample, rinse electrode with a small volume of your sample liquid.
2. Press ON to switch on meter.
3. Dip the electrode into the sample.

When dipping the electrode into the sample, take care to ensure that the liquid level is above its upper steel band. Stir the electrode gently in the sample to create a homogenous sample.

4. Allow time for the reading to stabilise. Note the reading on the display.
5. Press the MODE key to toggle between conductivity and TDS readings.

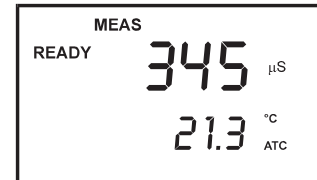

Figure 18:
Measurement Mode

5.3.1 Taking measurements with READY indicator selected on

If the READY indicator has been activated, the READY annunciator lights when the reading is stable. Switch the READY indicator on or off in SETUP program P 1.1. See page 38 for directions.

5.3.2 Taking measurements with the Auto HOLD feature selected on

This feature is only available in CON 110.

When a reading is stable for more than 5 seconds, the Auto HOLD feature will automatically “hold” the reading. The “HOLD” indicator appears on the left side of the display. Press the HOLD/ENTER key to release the reading. To activate the Auto HOLD feature in SETUP program P 1.1, see page 38 for directions.

5.4 Using Manual Ranging Function

Your meter automatically selects the range in which your readings appear. The manual ranging function lets you select the specific range you want to work in:

Meter Range Symbol	Conductivity Range	TDS Range
r1	0 to 19.99 $\mu\text{S}/\text{cm}$,	0.00 to 9.99 ppm
r2	20.0 to 199.9 $\mu\text{S}/\text{cm}$	10.0 to 99.9 ppm
r3	200 to 1999 $\mu\text{S}/\text{cm}$;	100 to 999 ppm
r4	2.00 to 19.99 mS/cm ,	1.00 to 9.99 ppt
r5	20.0 to 199.9 mS/cm	10.0 to 99.9 ppt

5.4.1 Selecting manual range

- To select the desired measuring range, press the RANGE key while in measurement mode. A momentary display of either "r1" to "r5" will flash indicating the range you are in. The range selected will appear on the display and the "MEAS" indicator blinks indicating that you are in manual range.
- Press the range key again (if needed) until desired range is selected. To re-select the auto-ranging function, repeatedly press the range key until the "MEAS" indicator appears without blinking.

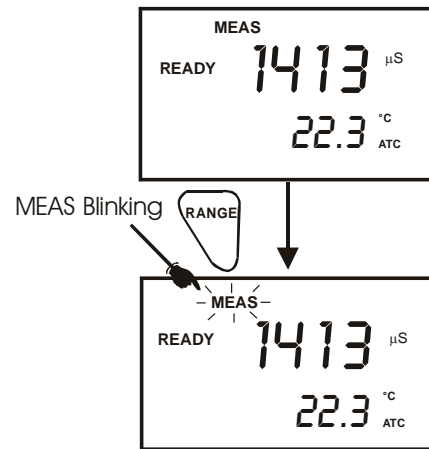

Figure 19: Selecting Manual Range

NOTES

If the value of the solution you are measuring is higher than the range selected, "Or" will appear on the primary display. Press RANGE until the correct range is selected.

The meter resets to the Auto-ranging function once it is turned off. You will have to reset the manual ranging function each time you turn the meter off.

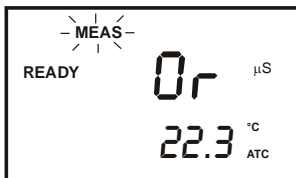

Figure 20: Out of Range

5.5 HOLD Function

This feature lets you freeze the display for a delayed observation. HOLD/ENTER can be used any time in MEAS mode.

1. To hold a measurement, press the HOLD/ENTER key while in measurement mode. "HOLD" will appear on the display.
2. To release the held value, press the HOLD/ENTER again. Continue to take measurements.

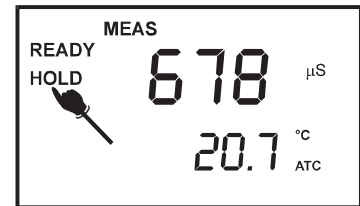

Figure 21: HOLD freezes measurement

NOTE:

- If the meter is shut off either automatically or manually, the HOLD value will be lost. For longer storage, use the memory functions (see pages 26).

6 MEMORY FUNCTION

6.1 Memory Input

CON 11/110 meter stores up to 50/100 set of data respectively. Data sets can include both conductivity and TDS measurement values and its temperature.

1. During any measurement function (MEAS), press MI/▲ key to input any data into the memory. MEM, “StO” and memory number will appear for a moment after which the meter then returns to measurement mode.
2. If necessary, measure the next sample solution and press MI/▲ key to input the next data into the memory.

NOTE: If the memory is full, the display will flash “FUL” momentarily. The first value stored will be erased to create space for the new value.

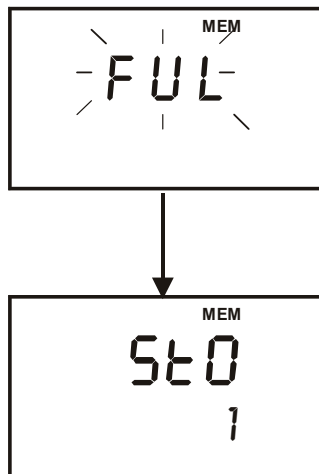

Figure 23: Memory full

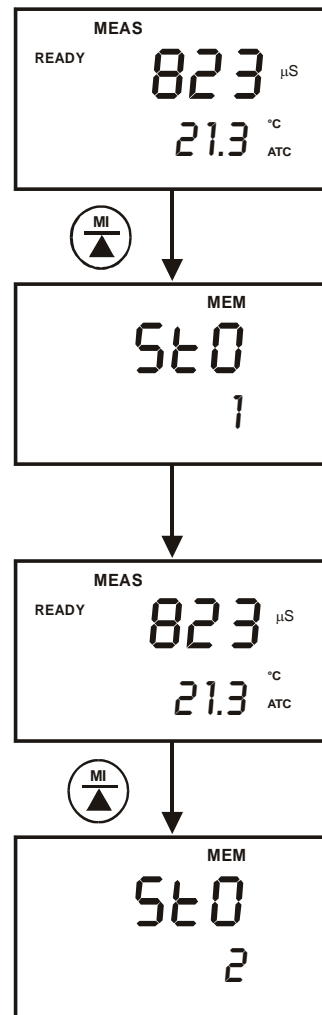

Figure 22: Data storage in memory

6.2 Memory Recall

This function recalls the previous readings stored in the memory. You can access memory recall function from the measurement mode only. Memory recall is in "Last In First Out" order.

1. Press the MR/▼ key once to retrieve the last reading stored. The memory location screen – MEM, "LOC" and the memory number – will be on the display.
2. Press the HOLD/ENTER key to recall the reading stored under that memory number.
3. Press HOLD/ENTER key again to return to the "memory location" screen. The display automatically moves to the next memory location screen.
4. If necessary, press the MI/▲ or MR/▼ keys to select the next "memory location" screen or press the HOLD/ENTER key repeatedly to select the previous "memory location" screen.
5. To exit Memory Recall, press CAL/MEAS key to return to Measurement mode.

NOTES:

Readings stored in memory are retained even if the units are turned off. To erase all readings stored in memory, use the SETUP menu Program P6.0 on page 47.

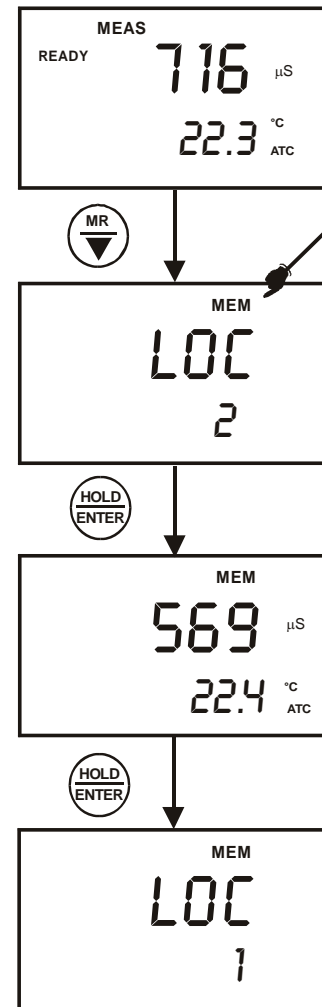



Figure 24 : Memory recall

7 PRINT FUNCTION (FOR CON 110 ONLY)

The CON 110 meter is equipped with an RS232 communication port and a PRINT () key that facilitate the printing of data from the meter to a printer or computer.

7.1 Using CON 110 Meter with Printer or Computer

1. To use the CON 110 directly with a printer, the printer should have either a 9 pin or a 25 pin RS 232C serial port.
2. Communication settings of the printer or computer's data acquisition software (CyberComm Portable DAS) MUST match the following parameters:
 - a. Baud Rate: 9600
 - b. Parity Bit: None
 - c. Stop Bit: One
 - d. Data Bit: 8
 - e. Flow Control: None

Please refer to your printer's or computer's instruction manual for more information on its communication setup protocol.

3. Use 9-pin cable (Refer to section –List OF Accessories on page 68) to connect the meter to the printer. If the printer has a 25 pin connector, use the 9 to 25 pin cable or make your own cable taking note of the connection parameters as described in section 3.6- Connecting the RS232C Cable (Only for CON 110) on page 9.
4. Turn on CON 110 meter and note the following:
 - a. For printer, ensure it is powered on and paper is loaded.
 - b. For computer, ensure that Eutech Instruments' CyberComm Portable Data Acquisition Software is installed and activated. See section 9.3- Running CyberComm Portable on page 59.
5. To send data to the printer or computer, press the PRINT () key.

7.2 Sending Data To Computer or Printer

When the PRINT () key is pressed, there are two options:

1. dAt / CUr: Prints current data on timed interval basis. The function enables the meter to continuously print the current data automatically based on the pre-set timing from 5 to 30 seconds.
2. dAt / StO: Prints stored data from memory. This function lets you print all the memorised data from memory previously stored in the meter. Each set of stored data will be send for printing based on preset timing from 0 to 30 seconds.

From Conductivity or TDS measurement mode.

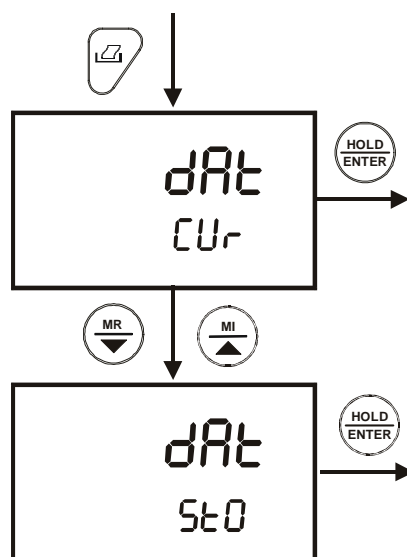



Figure 25: Print data based on timed interval or from memory



7.2.1 Printing Current Data Manually

To manually print any data that is currently being measured:

1. From measurement mode, press HOLD/ENTER key to freeze reading.
2. Press PRINT () key.
3. The “Prn – CUr” annunciator will appear and flash for about 0.5 seconds. The data is transmitted to the printer or computer.
4. The meter returns to measurement mode.
5. Repeat steps 1 to 3 for next measurement.

7.2.2 Print Data on Timed Interval

This feature is useful to automate printing and downloading ‘live’ measurement values into computer. The time interval setting can range from 5 to 30 seconds.

1. From conductivity or TDS measurement mode, press PRINT () key.
2. The “dAt/Cur” screen appears. Press the HOLD/ENTER key.
3. The “SEC 5” screen appears. The default value is 5 seconds time interval.
4. Press MI/▲ or MR/▼ key to set a value suitable for your application.
5. Press HOLD/ENTER key.
6. The meter goes into measurement mode with MEM annunciator flashing.
7. At a pre-set time interval, the screen flashes “Prn/CUr” momentarily (printing data) and switches back to measurement mode with MEM annunciator flashing.
8. To stop printing, press PRINT () key. The MEM annunciator disappears and the meter is on measurement mode.

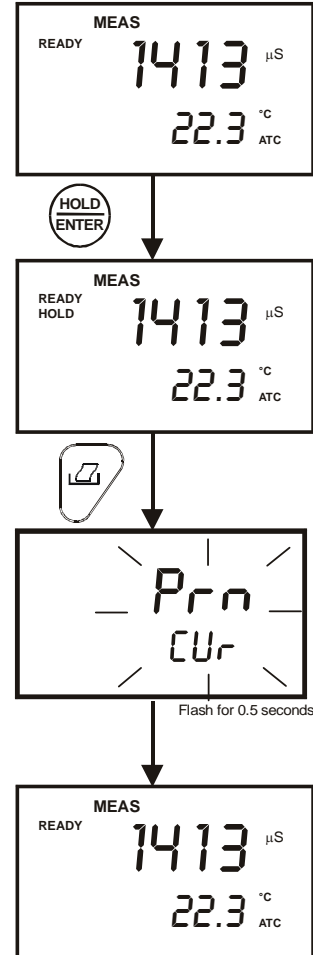

Figure 26: Print Current data manually

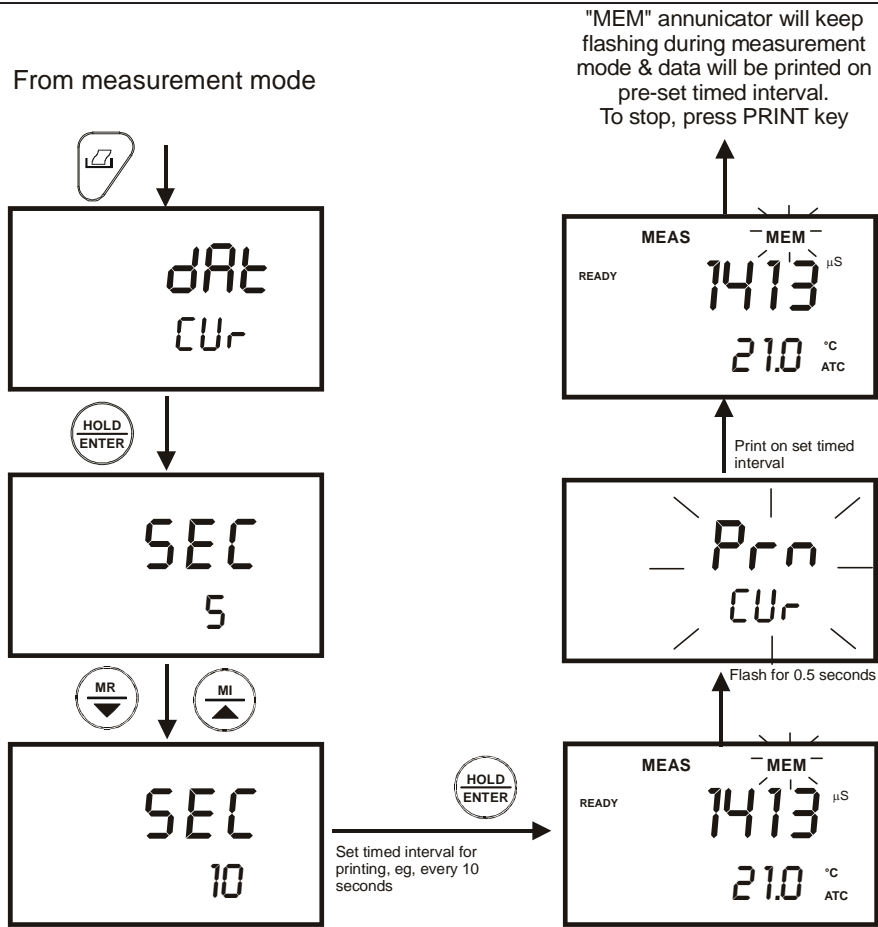



Figure 27: Print data on timed interval

7.2.3 Print Data from Stored Memory

The CON 110 meter can print data that is stored in the memory. You can print out all stored data or selected data based on its memory location.

To Print All Stored Data

1. From measurement mode, press PRINT () key.
2. Use MI/▲ or MR/▼ key, select “dAt – StO” option and press HOLD/ENTER key.
3. At the “SEC – 0” option, use MI/▲ or MR/▼ key to select number of seconds to print each data stored data. This setting gives flexibility to match the meter to a printer’s or computer’s ability to accept data.
4. Press HOLD/ENTER key. The “Prn” primary display will flash until all data is printed.
5. To stop printing, press PRINT () key and exit to measurement mode.

NOTE: All stored memory will remain in the meter after printing.

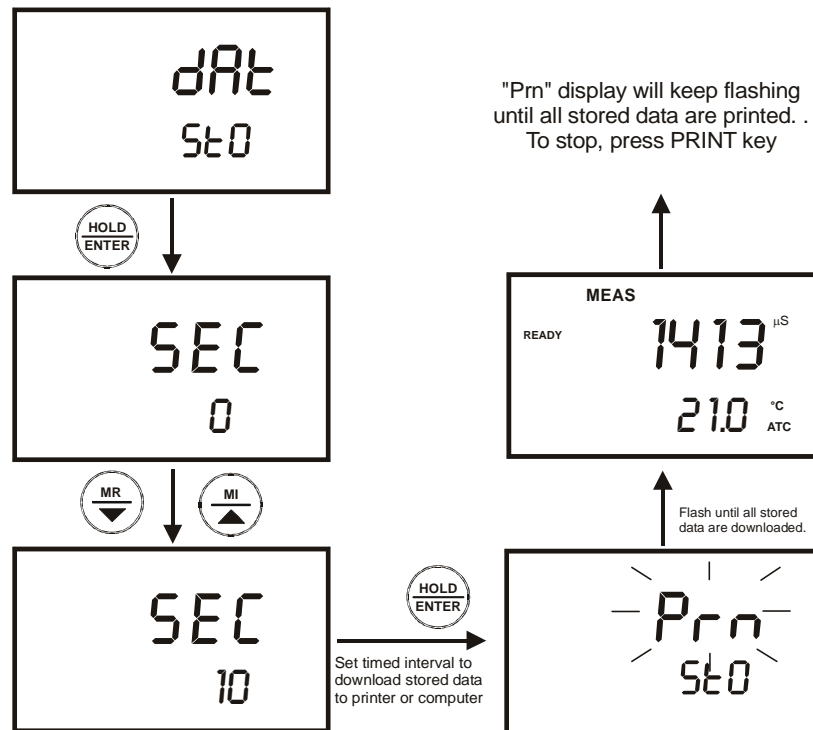

Figure 28: Print all stored data

To print Selected Stored Data

1. From measurement mode, press MR/▼ key.
2. A “MEM” indicator appeared and the last memory input location is displayed.
3. Press MI/▲ or MR/▼ key to select a specific memory location, and press HOLD/ENTER key.
4. When ready, press PRINT (🖨️) key.
5. The screen flashes “Prn/CUr” for about 0.5 seconds and switches back to the stored data of the specific memory location.
6. Press HOLD/ENTER key. The meter is now ready to recall the next stored data in the following memory location.

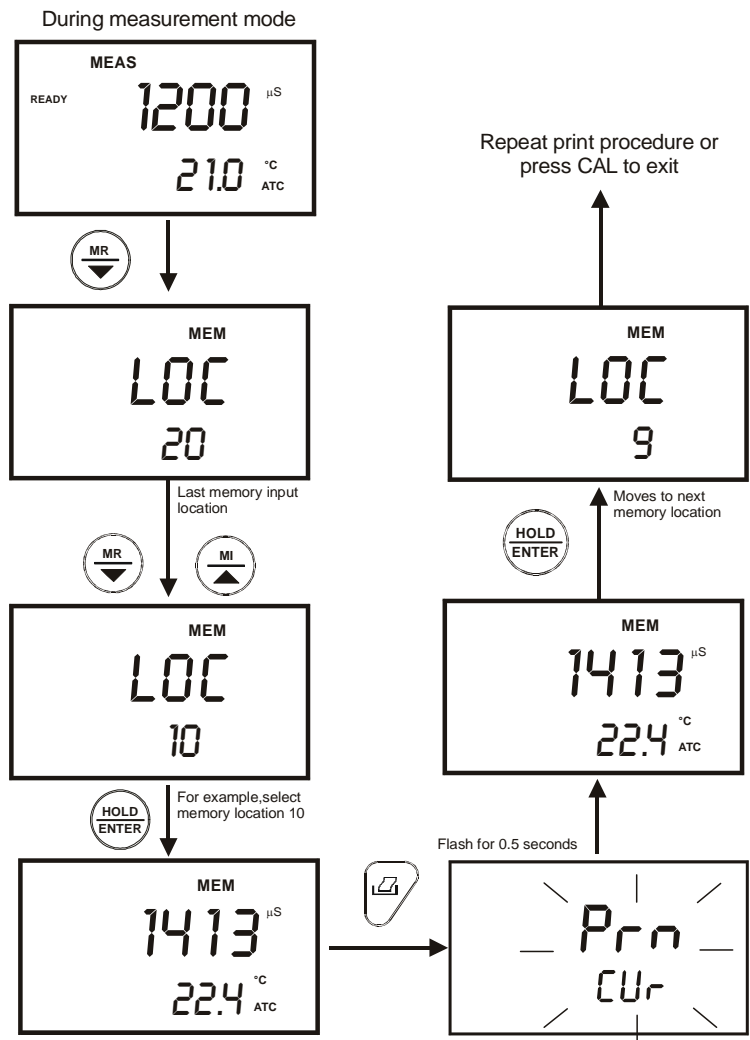

Figure 29: Print based on selected stored data from memory

For more information about Eutech Instruments' CyberComm Portable Data Acquisition Software programme, see page 53 - CYBERCOMM PORTABLE DAS (FOR CON 110 ONLY)

8 ADVANCED SETUP FUNCTION

The advanced setup mode lets you customised your meter's preferences and defaults. The CON 11/110 meter features different sub-groups that organise setup parameters.

The sub-groups are:

1. P1.0: Unit Configuration (COF)
2. P2.0: Viewing previous calibration data (CAL)
3. P3.0: Viewing electrode data (ELE)
4. P4.0: Auto Power OFF (AtO)
5. P5.0: Reset to factory defaults (rSt)
6. P6.0: Memory Clear (CLr)
7. P7.0: Temperature (tPr)
8. P8.0: Selection of cell constant (CEL)
9. P9.0 : Automatic and Single point Calibration (ASC)

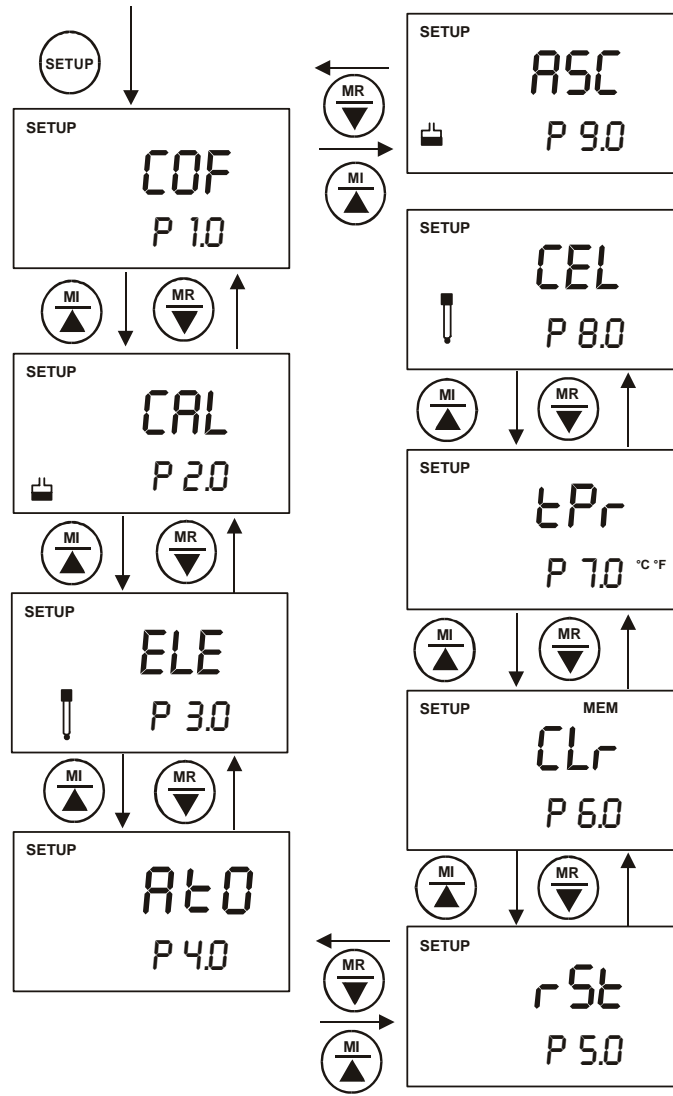



Figure 30: Overall view of advanced SET UP Programs

8.1 Advanced SETUP Mode Overview

1. Press the SETUP key to enter Set Up menu.
2. Press the MI/▲ or MR/▼ keys to scroll through sub groups.
3. Press HOLD/ENTER key to enter a particular parameter.

<p>SETUP COF P 1.0</p>	<p><u>P1.0: Unit Configuration</u> P1.1 Selection of READY and *Auto HOLD function (*CON 110 Only). P1.2 Selection of °C or *°F (*CON 110 Only) P1.3 Selection of Automatic or Manual Temperature Compensation P1.4 Selection of TDS Conversion Factor (This mode only appears when SETUP Menu is chosen while in the TDS measurement mode)</p>
<p>SETUP CAL P 2.0</p>	<p><u>P2.0: Viewing previous calibration data</u> P2.1 First range calibration point P2.2 Second range calibration point P2.3 Third range calibration point P2.4 Fourth range calibration point P2.5 Fifth range calibration point</p>
<p>SETUP ELE P 3.0</p>	<p><u>P3.0: Viewing electrode data</u> P3.1 Effective cell constant for first range P3.2 Effective cell constant for second range P3.3 Effective cell constant for third range P3.4 Effective cell constant for fourth range P3.5 Effective cell constant for fifth range</p>
<p>SETUP Ato P 4.0</p>	<p><u>P4.0: Auto Off</u> P4.0 Selection of automatic power off function</p>
<p>SETUP rSt P 5.0</p>	<p><u>P5.0: Reset to factory defaults</u> P5.1 Resetting of all calibration and clear all calibration data P5.2 Resetting of all User settings to factory defaults condition</p>
<p>SETUP MEM CLr P 6.0</p>	<p><u>P6.0: Memory clear</u> P6.0 Clearance of all stored readings</p>
<p>SETUP tPr P 7.0 °C*F</p>	<p><u>P7.0: Temperature</u> P7.1 Setting of temperature coefficient P7.2 Setting of normalisation temperature</p>

<p>SETUP</p>  <p>CEL P 8.0</p>	<p><u>P8.0: Selection of cell constant</u> P8.0 Selection of cell constant: K = 1.0, 10, or 0.1</p>
<p>SETUP</p>  <p>ASC P 9.0</p>	<p><u>P9.0: Automatic and Single Point Calibration</u> P9.1 Selection of Automatic or Manual Calibration (This mode only appears when SETUP Menu is chosen while in the Conductivity measurement mode P9.2 Selection of Single or Multi Point Calibration</p>

8.2 P1.0: Unit Configuration (COF)

8.2.1 P1.1: Selection of READY and Auto HOLD function

Program P1.1 gives you an option to on or off the “READY” display which indicates the measurement stability during a measuring process.

Program P1.1 also gives an option to activate the Auto HOLD function (Only for CON 110). Activating the auto HOLD function lets the meter to “hold” your measurement when it is stable for more than 5 seconds. The display automatically freezes, and HOLD indicator appears on the left side of the display. Press the HOLD key to release the display and access other functions. Deactivate the auto HOLD function if you do not want this feature.

From measurement mode

- 1 Press SETUP key to enter Set Up menu.
- 2 Press the HOLD/ENTER key to view parameter P1.1.
- 3 Press the MI/▲ or MR/▼ keys to select the configuration you require.
 - “ON” activates the READY function.
 - “OFF” deactivates the READY function.
 - “ON” and “HOLD” activates the Auto HOLD function.
- 4 Press HOLD/ENTER key to confirm selection.
- 5 Press the CAL/MEAS key to return to measurement mode.

NOTE: Meter default is set for Ready function on, and auto HOLD function off.

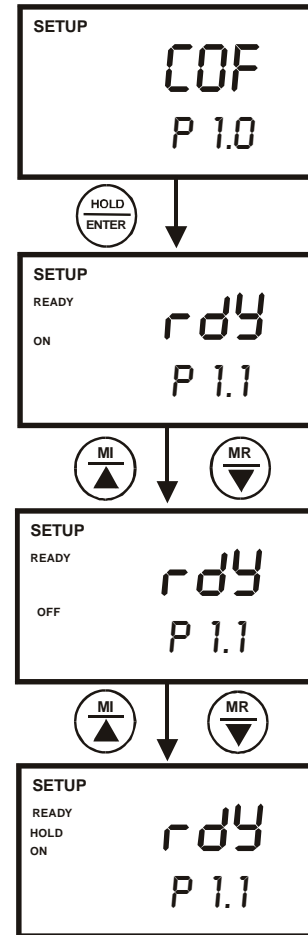

Figure 31: P1.1-
Configure READY ON,
OFF or HOLD

8.2.2 P1.2: Selection of °C or °F

Available in CON 110 only

You can select between °C and °F units for temperature readings. Meter default is °C.

From measurement mode

1. Press SETUP key to enter Set Up menu.
2. Press the HOLD/ENTER keys until you view parameter P1.2.
3. Press the MI/▲ or MR/▼ key to select between °C and °F.
4. Press the HOLD/ENTER key to confirm selection.
5. Press the CAL/MEAS key to return to measurement mode.

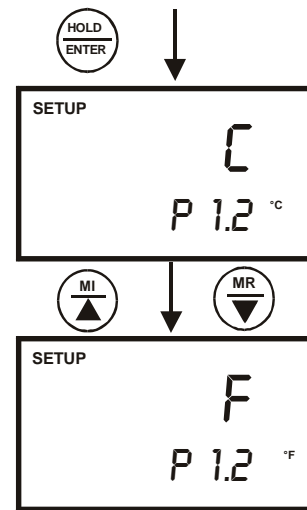

Figure 32: P1.2-Select °C or °F

8.2.3 P1.3: Selection of Automatic or Manual Temperature Compensation

This feature lets you select between Automatic Temperature Compensation (ATC) and Manual Temperature Compensation (MTC). Meter default is ATC.

From measurement mode

- 1 Press SETUP key to enter Set Up menu.
- 2 Press the HOLD/ENTER keys until you view parameter P1.3.
- 3 Press the HOLD/ENTER key again. The upper display shows "ATC" and the lower display shows "YES" or "NO".
- 4 Press MI/▲ or MR/▼ keys to select between Automatic and Manual Temperature Compensation.
 - "YES" activates the Automatic Temperature Compensation function.
 - "NO" activates the Manual Temperature Compensation function.
- 5 Press the HOLD/ENTER key to confirm selection and to return to the subgroup menu.
- 6 Press the CAL/MEAS key to return to measurement mode.

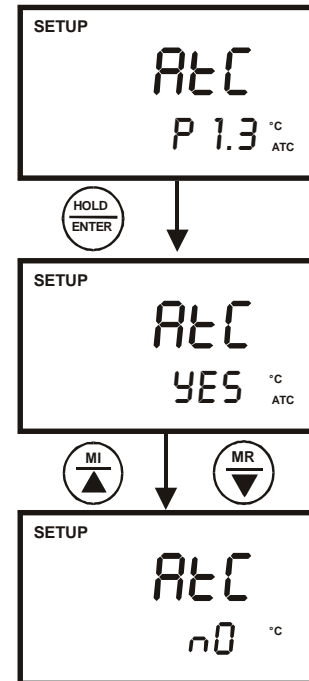

**Figure 33: P1.3-
Select Automatic or
Manual Temperature
Compensation**

8.2.4 P1.4: Selection of TDS Conversion Factor

You can set the TDS conversion factor between 0.40 and 1.00; meter default is 0.50.

NOTE: Your meter has to be in the TDS measurement mode before you can make the selection of the TDS Conversion Factor in the SETUP menu.

Only from TDS measurement mode

1. Press SETUP key to enter Set Up menu.
2. Press the HOLD/ENTER keys until you view parameter P1.4.
3. Press the HOLD/ENTER key again. The upper display shows a value and the lower display shows "tdS".
4. Press the MI/▲ or MR/▼ keys to select your calculated TDS conversion factor.
5. Press the HOLD/ENTER key to confirm selection and to return to the subgroup menu.
6. Press the CAL/MEAS key to return to measurement mode.

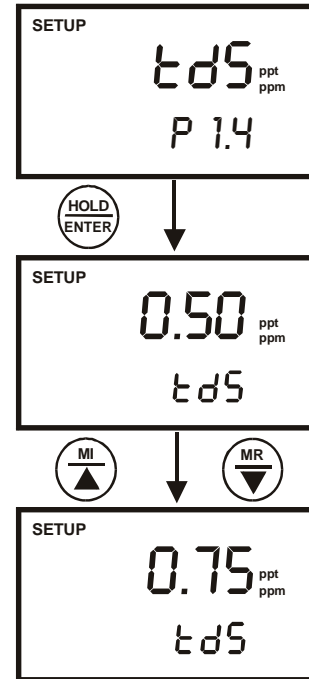

Figure 34: P1.4 -Select TDS Conversion Factor

8.3 P2.0: Viewing calibration data

This mode lets you recall the previous calibration data on each of the five measuring ranges. This is a “view only” mode.

From measurement mode:

1. Press the SETUP key to enter Set Up menu.
2. Press the MI/▲ or MR/▼ key until you view parameter P2.0.
3. Press the HOLD/ENTER key repeatedly to view the previous calibration data on each of the five measuring ranges.
4. Once you have scrolled through all calibration data, you will automatically return to the subgroup menu.
5. Press CAL/MEAS key to return to the measurement mode.

NOTES: If there is no previous calibration data at a particular point, the primary display will show “----”.

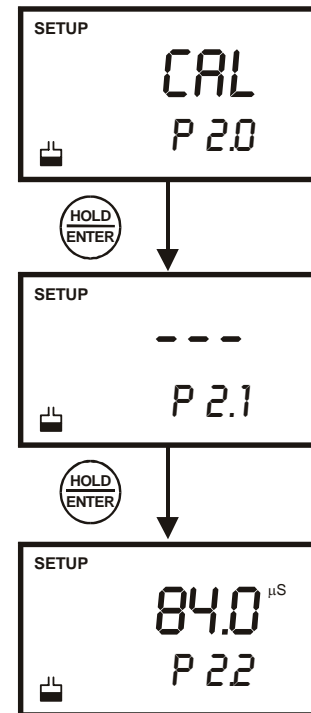

Figure 35: P2.0 –Viewing previous calibration data for each measurement range

8.4 P3.0 Viewing Electrode Data

Program 3.0 has five “view only” options that let you check the electrode’s parameters for diagnostic purposes. These options show you the effective cell constant for each range. The cell constant is adjusted according to your calibration.

From measurement mode

1. Press the SETUP key to enter Set Up menu.
2. Press the MI/▲ or MR/▼ keys until you view parameter P3.0.
3. Press the HOLD/ENTER key repeatedly to view the effective cell constant for each range.
4. When you have scrolled through all the electrode data, you will automatically return to the subgroup menu.
5. Press the CAL/MEAS key to return to measurement mode.

NOTES: Cell constants will degrade with time and usage. You can use this feature to alert you to the need for a new electrode prior to total failure.

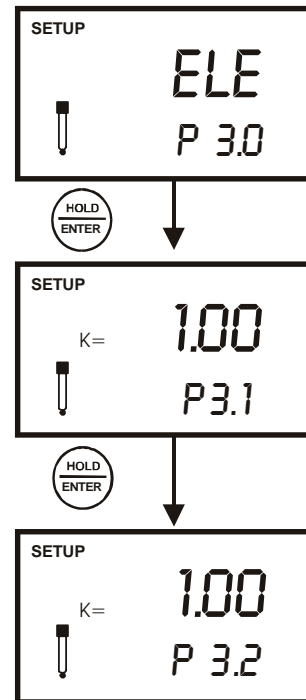

Figure 36: P3.0-Viewing electrode data for each measurement range

8.5 P4.0: Auto Off

In Program P4.0 you can activate the Auto Off option to automatically switch off the instrument 20 minutes after the last key selection. This feature is useful for conserving battery power. Under default conditions, the instrument has this option activated.

1. Press the SETUP key to enter Set Up mode.
2. Press the MI/▲ or MR/▼ keys until you view parameter P4.0.
3. Press the HOLD/ENTER key. The upper display shows "AtO" and the lower display shows "YES" or "NO".
4. Press MI/▲ or MR/▼ keys to select options
 - YES – activates the Auto Off function
 - NO - deactivates the Auto Off function
5. Press the HOLD/ENTER key to confirm and return to subgroup menu.
6. Press the CAL/MEAS key to return to measurement mode.

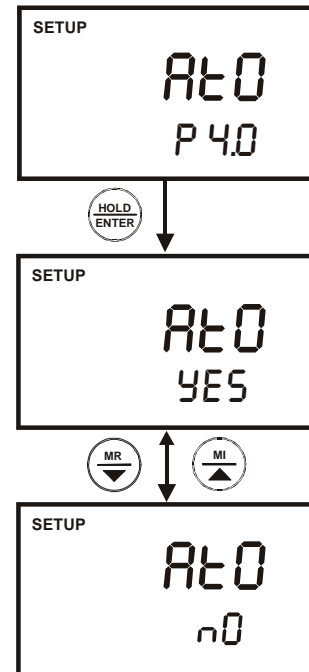

Figure 37: P4.0-
Selection of Auto
Power Off function

NOTE:

For datalogging using interval measurements, it is often desirable to use an AC adapter and disable the auto-off feature.

8.6 **P5.0: Reset to factory defaults**

Program 5.0 reset functions lets you have an option to only reset all the meter's calibrations and its data that have been stored or reset all calibrations, its stored data, memory, and any other setup functions that you might have changed back to factory default settings. See Factory Default Settings at page 69 and 70.

8.6.1 **P5.1: Calibration Reset**

This reset function clears all the calibrations and its data that have been set by you. All other setup parameters that you have changed are not reset.

From measurement mode

1. Press SETUP key to enter Set Up menu.
2. Press the MI/▲ or MR/▼ keys to until you view parameter P5.0.
3. Press the HOLD/ENTER key to enter parameter P5.1 with the upper display showing "CAL".
4. Press the HOLD/ENTER key again to enter the calibration reset selection mode.
5. Press the MI/▲ or MR/▼ keys to toggle between NO and YES.
 - NO retains current settings
 - YES clears all calibrations and its data.
6. Press the HOLD/ENTER key to confirm selection and to return to measurement mode. Otherwise press CAL/MEAS key to return to measurement mode without resetting the calibration data.

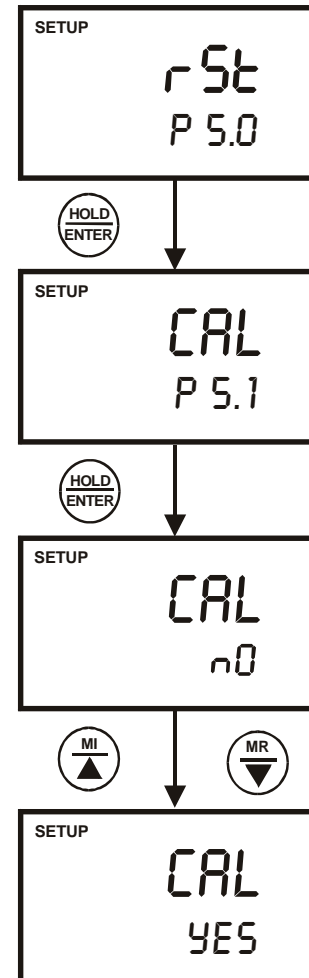

Figure 38: P5.1-Clear all calibration and its data

8.6.2 P5.2: User Reset

This reset function clears all the calibrations, memory and all other setup parameters that you have changed back to factory defaults condition.

From measurement mode

1. Repeat step 1 to 4 to enter the calibration reset selection mode.
2. Press the MI/▲ or MR/▼ keys to select NO.
3. Press the HOLD/ENTER key to enter parameter P5.2. The upper display will show "USr".
4. Press the HOLD/ENTER key again to enter user reset selection mode.
5. Press the MI/▲ or MR/▼ keys to toggle between NO and YES.
 - NO retains current settings
 - YES resets to factory default settings.
6. Press the HOLD/ENTER key after confirming reset selection and to return to the measurement mode. Otherwise press CAL/MEAS key to return to measurement mode without resetting to factory default.

NOTE: See page 69 and 70 for Factory Default Settings.

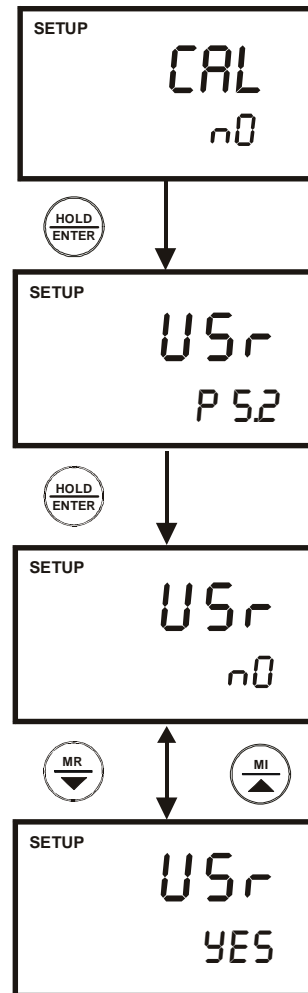

Figure 39: P5.2-Clear all setups to factory default

8.7 P6.0: Memory Clear

Use this program to clear all memory values when you need to store a new series of values. This is to avoid confusion between the old values and the new ones.

From measurement mode:

1. Press the SETUP key to enter Set Up menu.
2. Press the MI/▲ or MR/▼ keys until you view the parameter P6.0.
3. Press the HOLD/ENTER key to enter parameter P6.0.
4. Press the MI/▲ or MR/▼ keys to toggle between NO and YES.
 - NO retains current memory.
 - YES clears all memory.
5. Press the HOLD/ENTER key to confirm selection and return to the subgroup menu.
6. Press CAL/MEAS key to return to measurement mode.

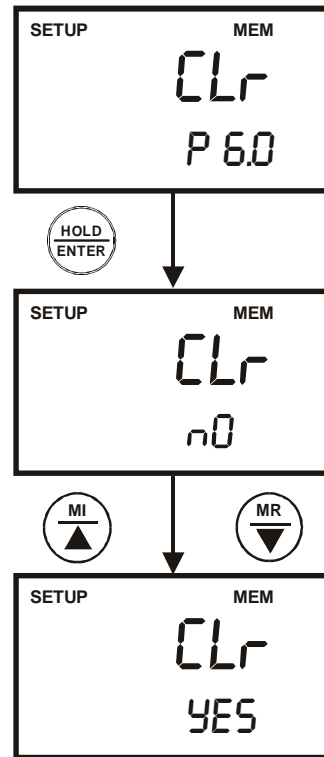

Figure 40: P6.0-Clearance of all stored memory

8.8 P7.0: Temperature

8.8.1 P7.1: Setting the temperature coefficient

The temperature coefficient is the amount of change in conductivity per degree of temperature; it is expressed in percent per °C.. Entering the exact temperature coefficient of your solution lets you accurately compensate temperature for almost any solution. You can adjust 0.0 to 10.0 % per °C. Meter default is 2.1% per °C. By setting the temperature coefficient to 0.0%, the meter will not apply any compensation but will display actual temperature.

From measurement mode

1. Press SETUP key to enter Set Up menu.
2. Press the MI/▲ or MR/▼ keys until you view parameter P7.0.
3. Press the HOLD/ENTER key to select parameter 7.1. The display shows “tCO” on the upper display.
4. Press the HOLD/ENTER key again. The upper display shows the default temperature coefficient “2.1”.
5. Press the MI/▲ or MR/▼ keys to select the temperature coefficient of your solution.
6. Press the HOLD/ENTER key to confirm.
7. Press the CAL/MEAS key twice to return to the measurement mode.

Notes

If you do not know the temperature coefficient of your solution you can determine the correct value using the formula in page 74 “Calculating Temperature Coefficients”.

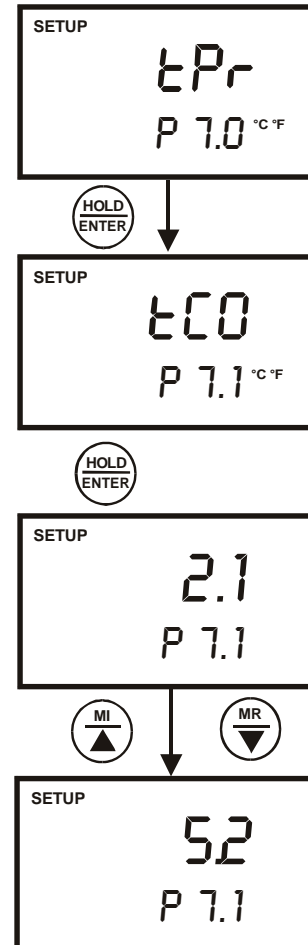

Figure 41: P7.1 – Setting Temperature Coefficient

8.8.2 P7.2: Setting the normalisation temperature

Your meter will normalise its conductivity measurements to a standard temperature that you can select. You can adjust the normalisation temperature either at 20.0°C or 25.0°C. Meter default is 25.0°C.

From measurement mode

1. Press SETUP key to enter Set Up menu.
2. Press the MI/▲ or MR/▼ keys until you view parameter P7.0.
3. Press the HOLD/ENTER key three times to select display “tnr” at parameter P7.2.
4. Press the HOLD/ENTER key again. The upper display shows the normalisation temperature of 25.0 °C.
5. Press the MI/▲ or MR/▼ keys to select either 20.0°C or 25.0°C as the normalisation temperature.
6. Press the HOLD/ENTER key to confirm selection and to return to the subgroup menu.
7. Press CAL/MEAS key to return to measurement mode.

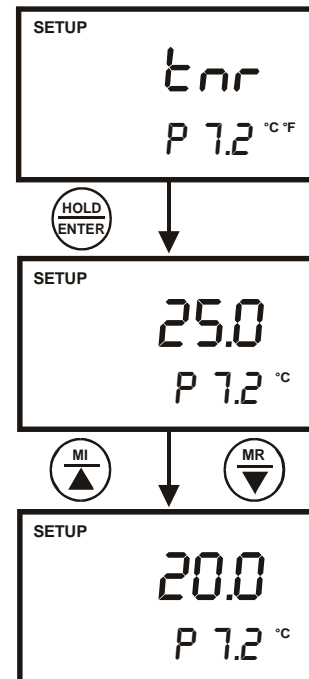

Figure 42: P7.2-Setting Normalisation Temperature

8.9 P8.0: Selection of cell constant

Your meter lets you select a cell constant of $K = 1.0$, 10 , or 0.1 .

Use a cell of $K = 1.0$ for midrange measurements

Use a cell of $K = 10$ for high range measurements (above 20 mS or 10 ppt).

Use a cell of $K = 0.1$ for low range measurements (below $20 \text{ }\mu\text{S}$ or 10 ppm).

The cell included with your meter has a cell constant of $K = 1.0$.

From measurement mode

1. Press SETUP key to enter Set Up menu.
2. Press the MI/▲ or MR/▼ keys until you view parameter P8.0.
3. Press the HOLD/ENTER key to enter parameter P8.0.
4. Press the MI/▲ or MR/▼ keys to select the cell constant between $K = 1.0$, 0.1 , or 10 .
5. Press the HOLD/ENTER key to confirm selection and to return to the subgroup menu.
6. Press the CAL/MEAS key to return to measurement mode.

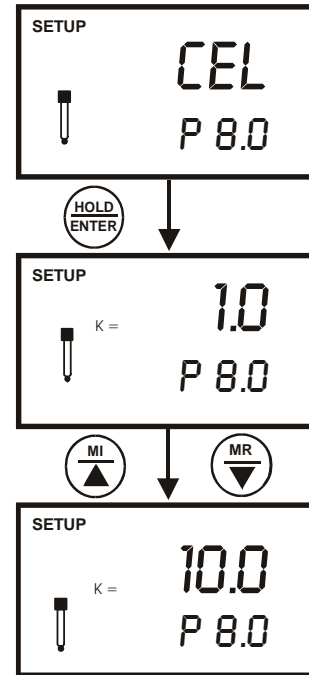

Figure 43: P8.0-
Selecting Cell Constant

8.10 P9.0: Automatic and Single point Calibration

You may select an automatic or manual calibration depending on the calibration standards that you have. Program 9.0 lets you have the option to do the above as well as the option of having a single or a multi point calibration.

8.10.1 P9.1: Selection of Automatic or Manual Calibration

The automatic calibration feature lets you calibrate the meter automatically by using the appropriate known calibration standard solutions whereas in the manual calibration feature non-standard calibration values can be used for calibration.

NOTE: Automatic calibration is applicable in conductivity measurement mode only whereas manual calibration is applicable in both conductivity and TDS mode.

Only from the **conductivity** measurement mode,

1. Press SETUP key to enter Set Up menu.
2. Press the MI/▲ or MR/▼ keys until you view parameter P9.0.
3. Press the HOLD/ENTER key to enter parameter P9.1. The upper display will show “ACA”.
4. Press the HOLD/ENTER key to enter the automatic or manual calibration selection mode.
5. Press the MI/▲ or MR/▼ keys to select “YES” or “NO”.
 - YES activates the automatic calibration.
 - NO activates the manual calibration.
6. Press the HOLD/ENTER key to confirm selection.
7. Press the CAL/MEAS key twice to return to measurement mode.

NOTE: Parameter P9.1 will only be in the Set Up menu if you enter from the conductivity measurement mode. If you enter from the TDS measurement mode, Parameter P9.1 will not be displayed.

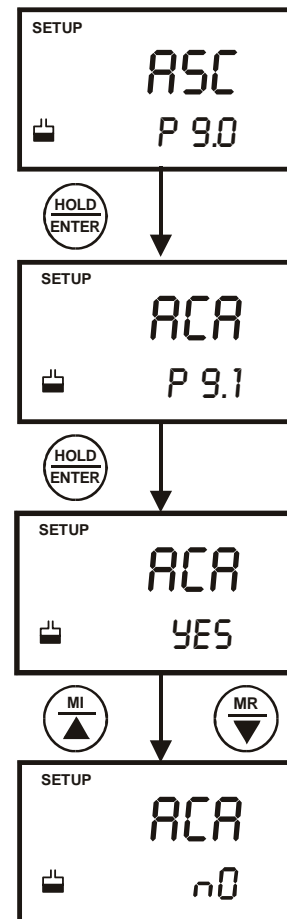

Figure 44: P9.1-Setting Automatic or Manual Calibration

8.10.2 P9.2: Selection of Single or Multi Point Calibration

The single point calibration lets you have a single calibration factor in all the five measuring ranges by just calibrating one point in either one of the five measuring ranges. When used in an automatic or manual calibration mode the calibration factor is applied to all the five ranges

The multi point calibration, on the other hand, gives you better calibration accuracy by letting you calibrate in each of the five ranges. Whether it is used in an automatic or manual calibration mode, the calibration factor would only be applicable in the particular range where the calibration is done.

1. Press SETUP key to enter Set Up menu.
2. Press the MI/▲ or MR/▼ keys until you view parameter P9.0.
3. Press the HOLD/ENTER key three times to enter parameter P9.2. The upper display will show "SPC".
4. Press the HOLD/ENTER key to enter the single or multi point calibration selection mode.
5. Press the MI/▲ or MR/▼ keys to select "YES" or "NO".
 - YES activates the single point calibration.
 - NO activates the multi point calibration.
6. Press the HOLD/ENTER key to confirm selection.
7. Press the CAL/MEAS key to return to measurement mode.

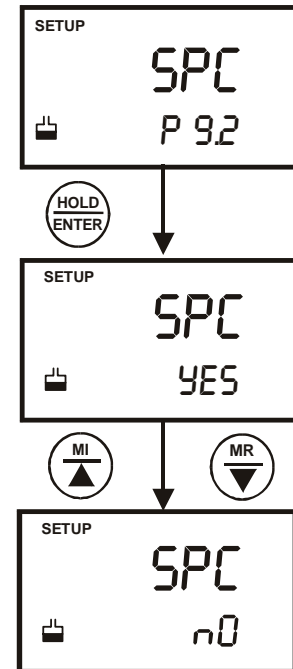

Figure 45: P9.2-
Setting Single or
Multi point
Calibration

9 CYBERCOMM PORTABLE DAS (FOR CON 110 ONLY)

The DAS software is designed for pH 110 and CON 110 meters to allow you a convenient means of capturing data for future analysis using other software program such as LOTUS 123, EXCEL or DBASE in Windows®. Often one finds it cumbersome to record and transfer data from one media to another before the required processing can be done. With the DAS software, this redundant processing can be eliminated or reduced.

9.1 System Requirements

To run the DAS program, the following is required:

1. PC - IBM Compatible XT and above with CD-ROM Drive
2. EGA Monitor and above
3. Windows® Operating System '95 and above
4. Connecting communication RS232C cable

9.2 Loading CyberComm Portable DAS

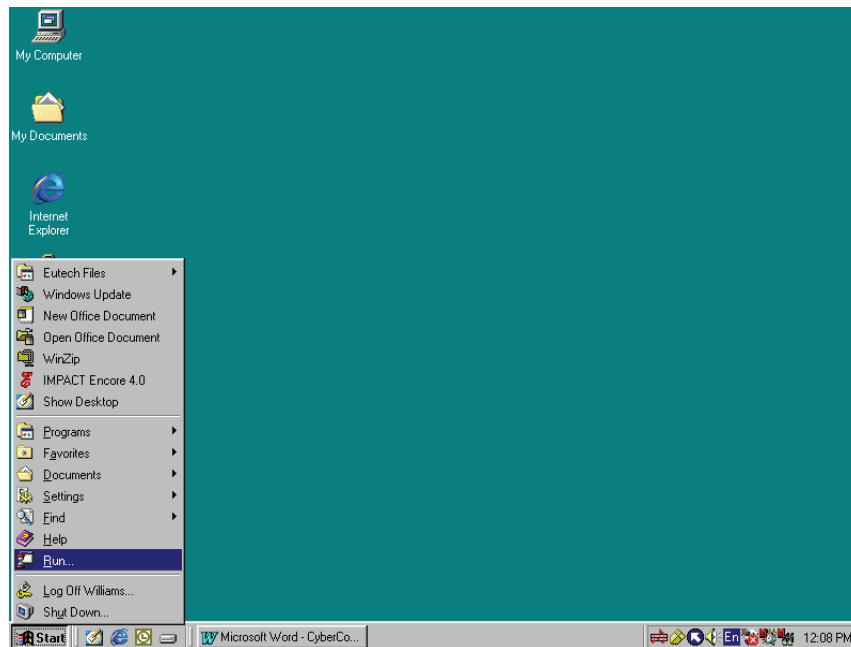

Figure 46: Insert Eutech Instruments' CD-ROM containing Data Acquisition Software (DAS) into your CD-ROM drive. It will Auto Run and let you start loading the software by displaying the screen as in Figure 49. Alternatively, you can also manually load the software by clicking the START button and RUN command.

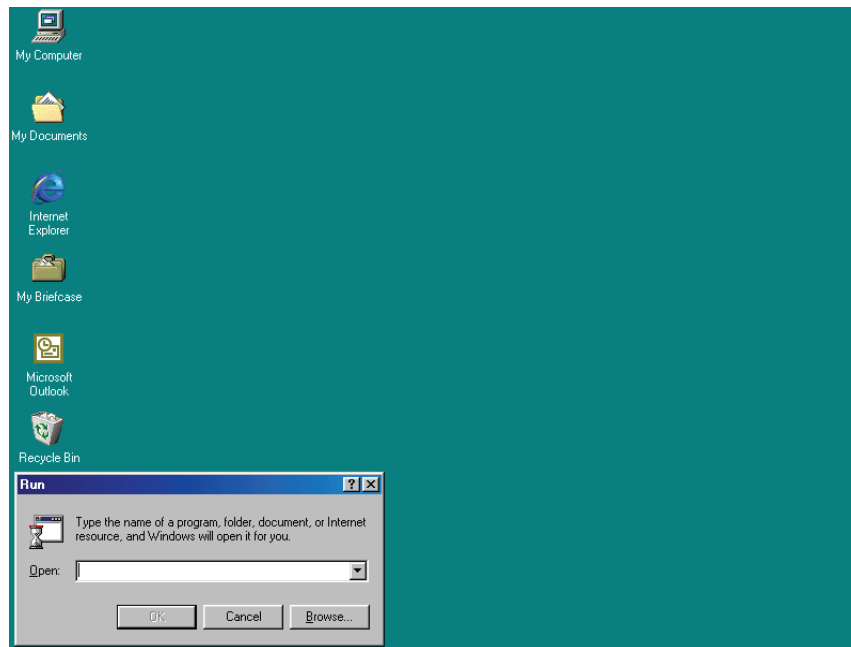

Figure 47: Click on 'Browse' button and locate CD-ROM drive

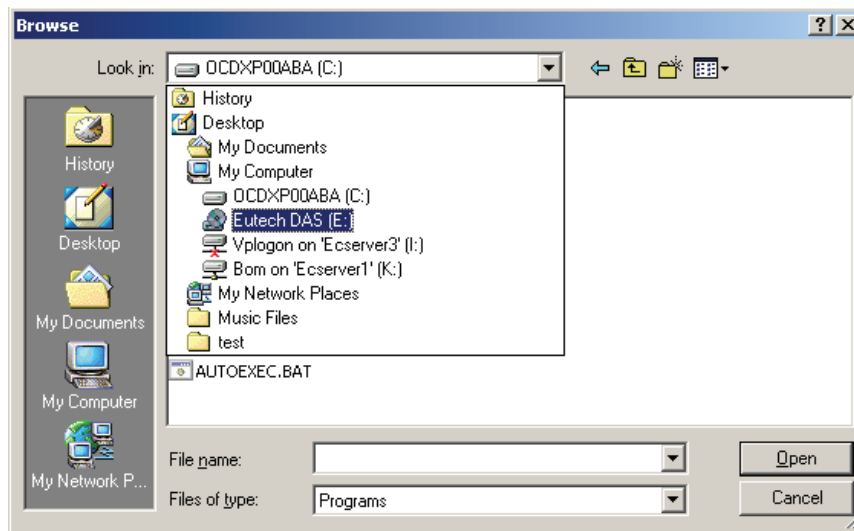

Figure 48 : Locate the CyberComm Portable Setup program in the CD-ROM under "Eutech DAS" directory.

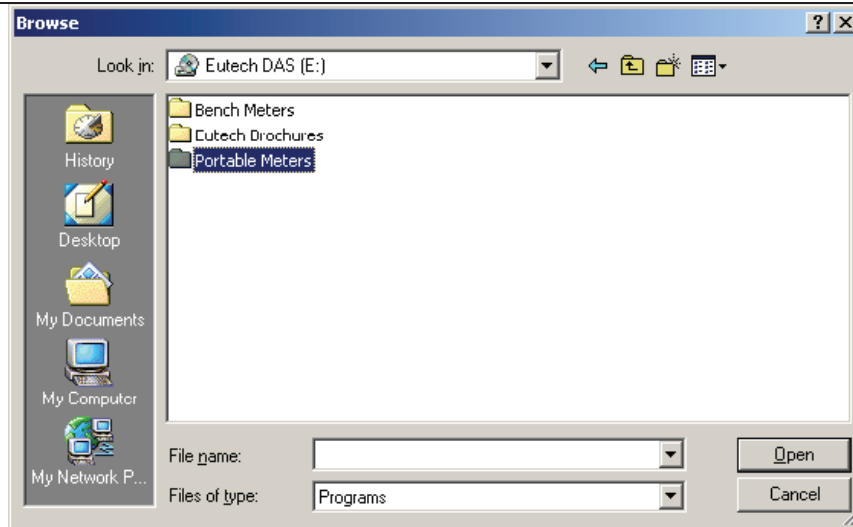

Figure 49: Select 'Portable Meters' directory to go to CyberComm Portable.

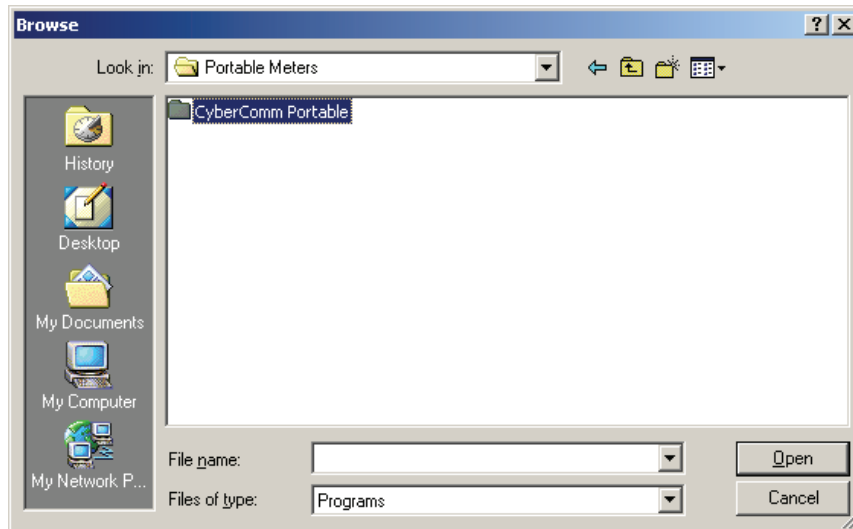

Figure 50 : Open 'CyberComm Portable' to enter to the Setup program.

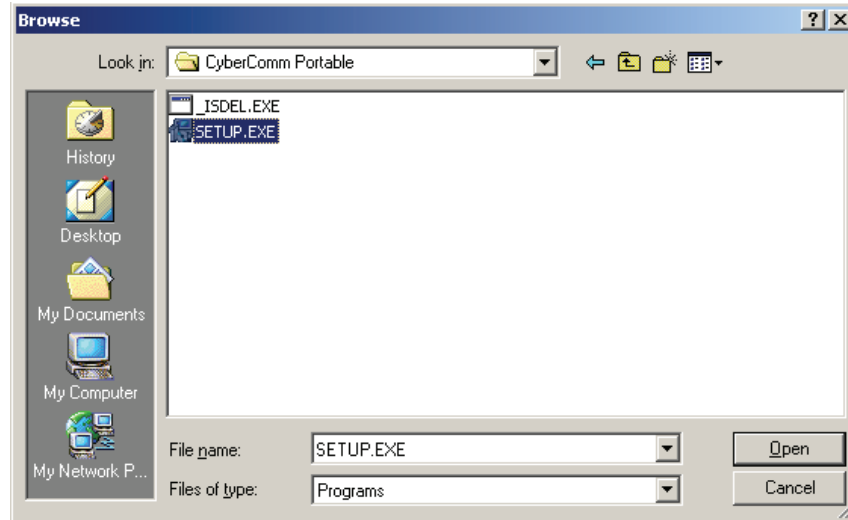

Figure 51: Select "SETUP.EXE" program and click the OPEN button

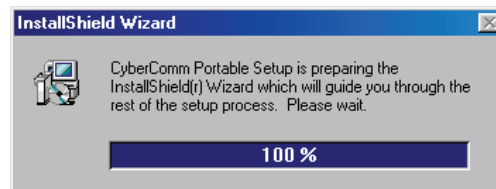

Figure 52: InstallShield Wizard dialog box appears.

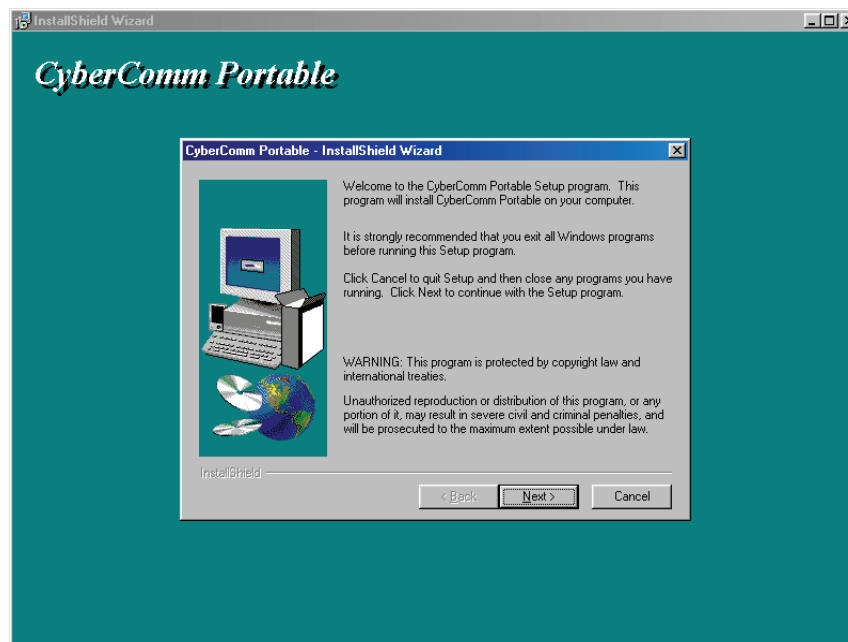

Figure 53: Click on Next button

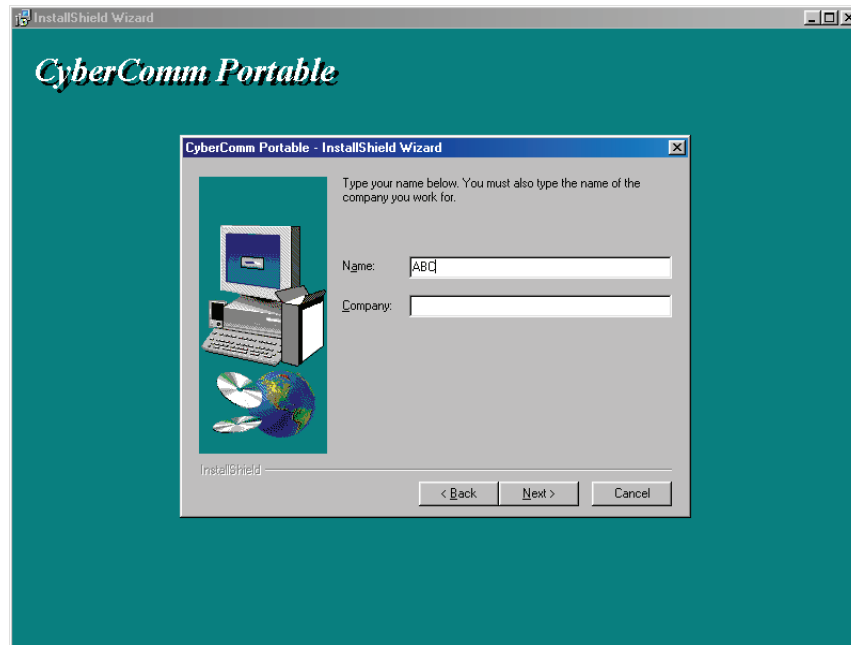

Figure 54: Key in your name and company name and click NEXT button

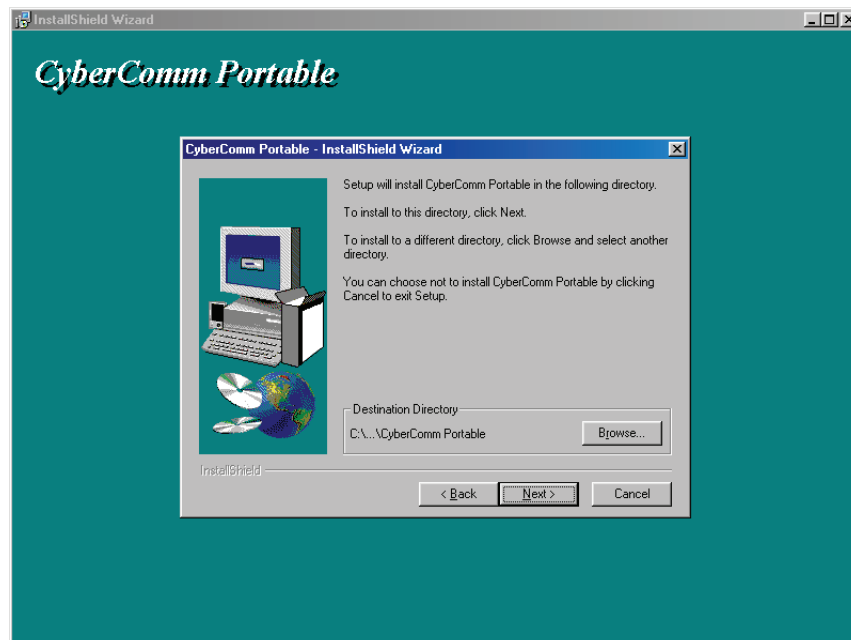

Figure 55: To select another Destination Directory to install the program, click on BROWSE button. Otherwise, click NEXT button.

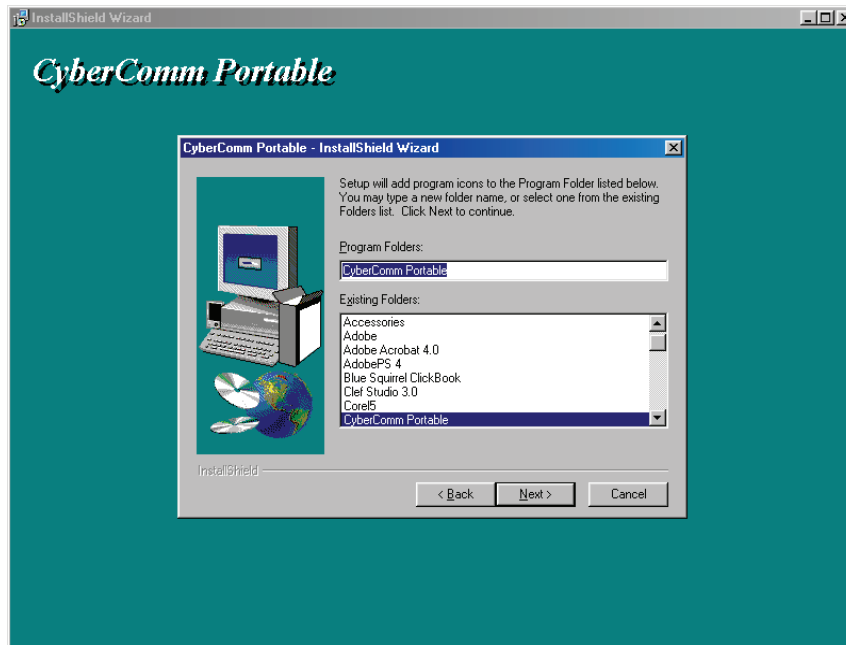

Figure 56: Creating a new program folder. Click on NEXT button.

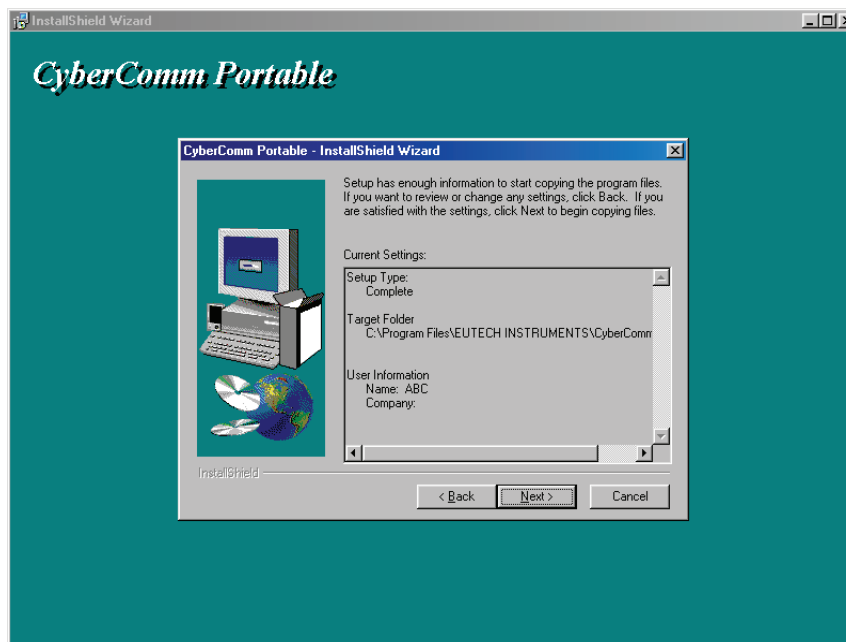

Figure 57: Click on NEXT button.

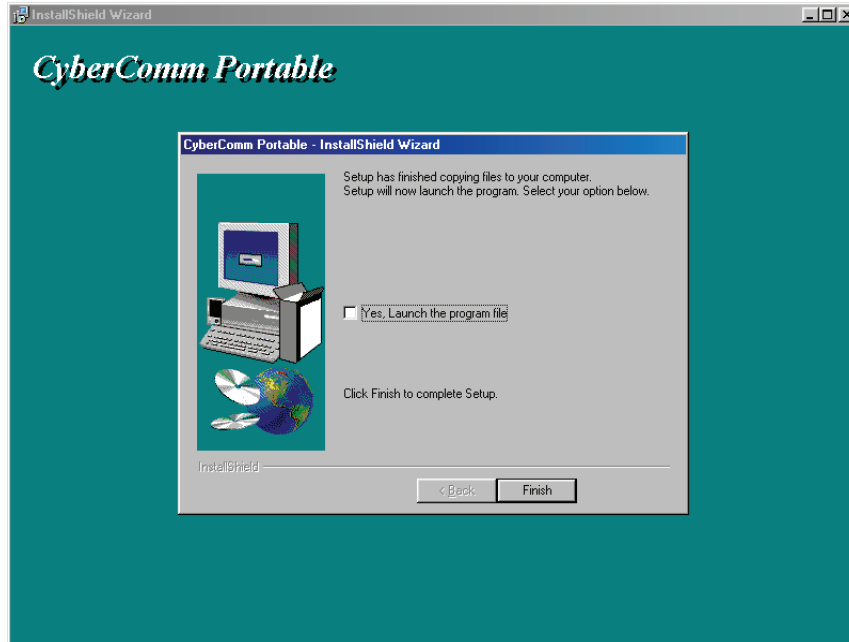

Figure 58: The CyberComm Portable DAS program is fully installed. Click on FINISH button to end installation.

9.3 Running CyberComm Portable

Before running the DAS program, please ensure that the RS232 cable is connected between the computer’s serial port and the meter’s port. See section 3.6- Connecting the RS232C Cable (Only for CON 110) on page 9.

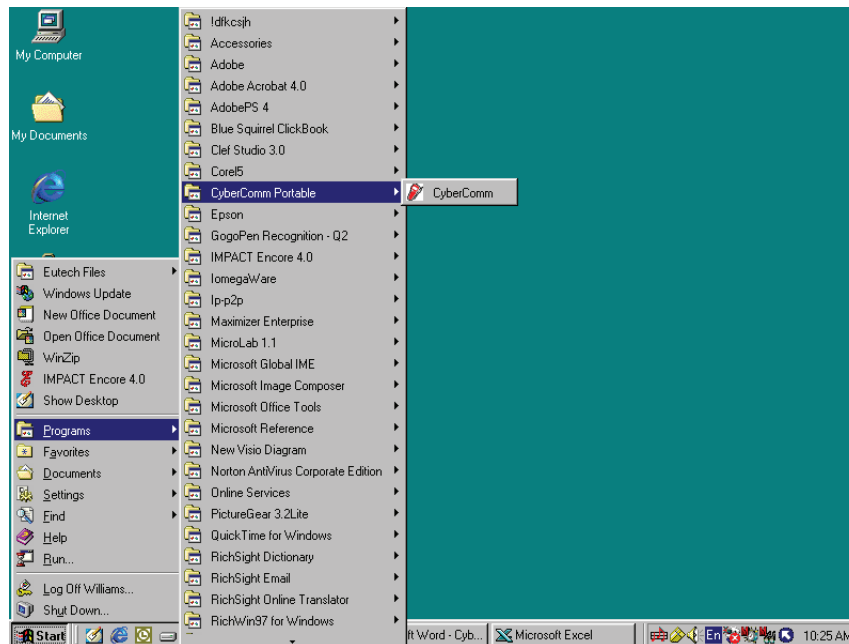

Figure 59: Run the CyberComm Software program

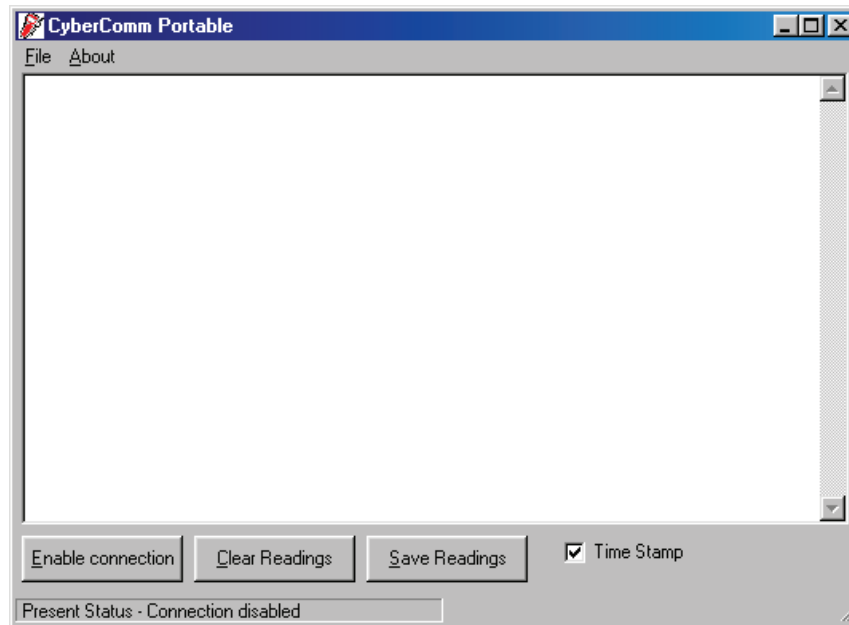

Figure 60: The opening screen will appear as above

9.3.1 Buttons & Check-Box

1. Enable Connection - Click this button to enable communication between meter and computer.
2. Clear Readings - To clear all data and start all over again.
3. Save Readings - To save all data displayed in either *.dat or *.txt format.
4. Time Stamp - To include Time and Date stamp when collecting the data. Time and date information comes from the computer.

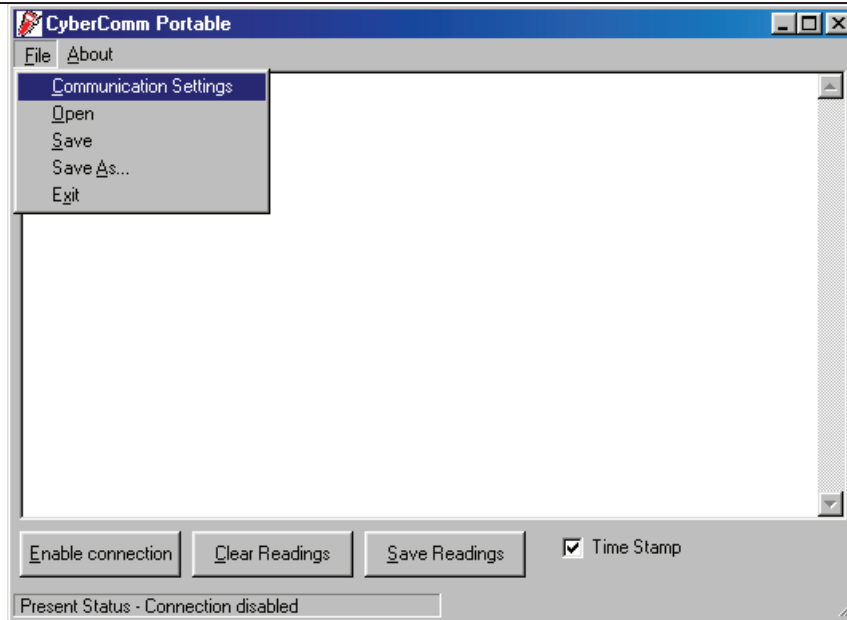

Figure 61: Under File Menu setting, you can change various parameters. Under ABOUT menu, details of Eutech Instruments' contact information, email address and updates are shown.

9.3.2 Menu

1. Communication Settings - To set communication port number, baud rate speed, parity and stop bits protocol.
2. Open - To open previously saved data file.
3. Save - To save current data captured.
4. Save As - To save current data set in another format such as *.dat or *.txt.
5. Exit - To exit from CyberComm Data Acquisition Software program.

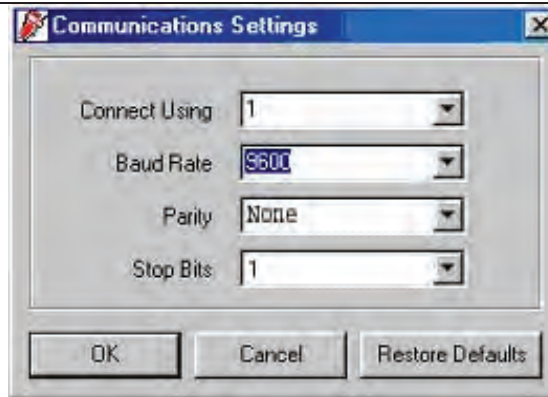

Figure 62: Communication Settings for computer's Com port. It must match with COM port settings on CyberScan CON 110 meters. Please refer to Section 7.1 "Using CON 110 Meter with Printer or Computer" on page 28 for the settings.

9.3.3 Communication Settings

1. Connect Using - For selecting communication port. (Select '1')
2. Baud Rate – For selecting baud rate. (Select '9600' bps (bits per second)).
3. Parity – For selecting parity. (Select 'None')
4. Stop Bits – For selecting stop bits. (Select '1')

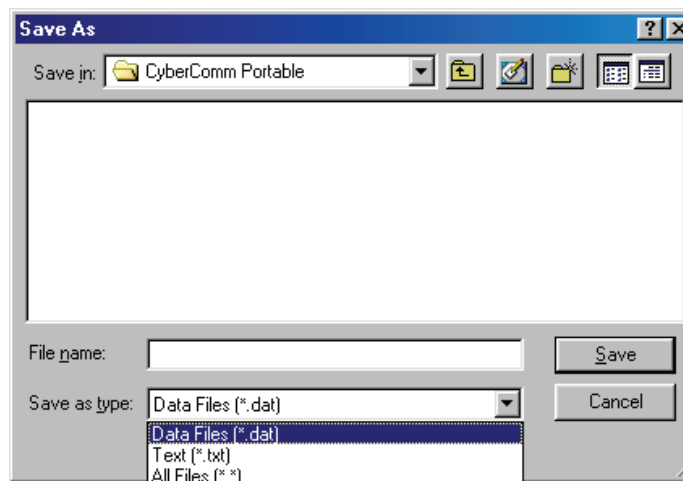

Figure 63: Under SAVE AS menu, you can save your data as *.dat or *.txt formats

9.4 Capturing And Printing Data Into Computer Using Data Acquisition

After matching the Communication Settings between your computer using Data Acquisition program and the CON 110 meter, you can now capture data into your computer for analysis and storage purposes.

1. Ensure the 1-meter RS232 communication cable (Refer to Accessories Section) is connected between the computer and the CON 110 meter's Com port. Refer to section 3.6 "Connecting the RS232C Cable (Only for CON 110)", page 9, for connection procedure.
2. Switch on the CON 110 meter and run the Data Acquisition software.
3. Click "ENABLE CONNECTION" button.
4. With the CON 110 meter switched on, press the PRINT key to send data to the computer.
5. You can use MODE key on the meter and change to other parameter such as TDS and print data accordingly.
6. You can also check off the Time Stamp function, so as to print without the Time and Date information.
7. You can click Clear Readings button to begin another set of measurements, or click Save Readings to store readings for future retrieval.

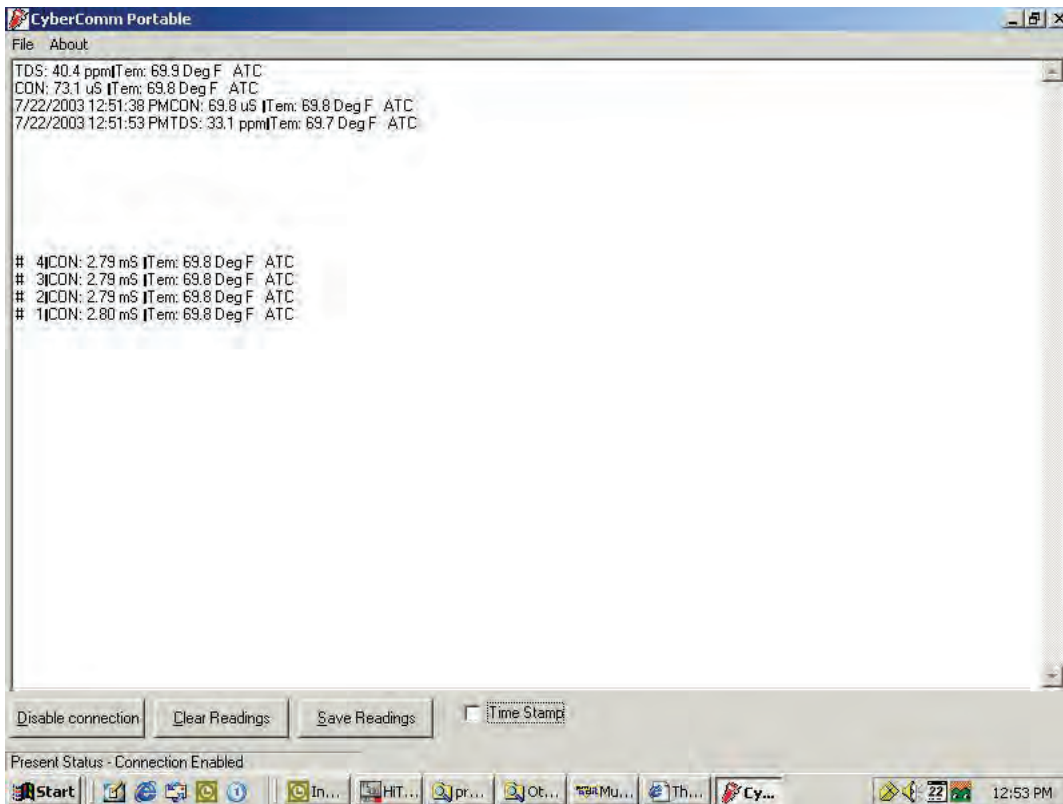

Figure 64: Example of a set of data print in CyberComm Portable DAS

9.5 Trouble-shooting Guide

Problem: Unable to PRINT

When press PRINT key on CON 110 meter, nothing is printed.

POSSIBLE CAUSES	SOLUTIONS
You have not "ENABLE CONNECTION" in the Data Acquisition program.	Click on "ENABLE CONNECTION" in the Data Acquisition program
The "Communication Settings" in the Data Acquisition program is different from meter's setup.	Match the COM port number, baud rate, parity and stop bits information between the Data Acquisition program and the meter.
The COM port number in the Data Acquisition program is wrong	Change the COM port number (1 or 2) in the Data Acquisition program.
Your computer's COM port setting may be wrong.	Check your computer's hardware settings (through Windows OS, BIOS, or any other OS) and refer to computer's manual or consult with the computer's manufacturer.
You may have used the wrong communication cable.	Make sure you use the RS232C cable supplied together with the meter (Part No. EC-CA01M09F09). Check the RS232C configuration as described in the meter's instruction manual.

10 ELECTRODE CARE AND MAINTENANCE

Keep the conductivity electrode clean. Rinse the electrode twice, and gently swirl it while you take readings. For best accuracy, soak a dry electrode for at least 5 to 10 minutes or longer before calibration. Rinse the electrode with de ionised or tap water before storing. Never scratch the bands with a hard substance. Do not strike the electrode against any hard surface.

Do not immerse the electrode in oily solutions. Clean the electrode thoroughly by stirring it in a mild detergent bath or isopropyl alcohol. Wipe the electrode with a soft tissue paper. Rinse thoroughly in tap water and then in de ionised water. Recalibrate the meter after cleaning the electrode.

The conductivity electrode (Order Part No: EC-CONSEN91W/ 35608-50) which is included with your meter features a removable electrode guard to make cleaning easy. This guard must be attached to the electrode during measurement or calibration.

To remove electrode guard:

1. Grip yellow electrode guard and twist counter clockwise. The locking notch will release.
2. Slide electrode guard off end of electrode.

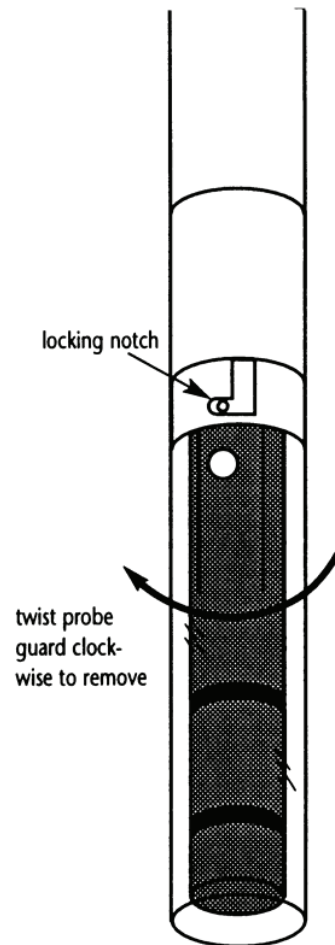

Figure 65: Conductivity Electrode (EC-CONSEN91W/35608-50)

11 ERROR MESSAGES

The following table provides a guideline to enable diagnosis of possible problems indicated by the messages generated by the meter. The table also provides possible solutions to the problems encountered.

ERROR MESSAGE	INDICATES	POSSIBLE CAUSE	CORRECTIVE ACTION
ERR. Annunciator	Wrong keypad input	Wrong input in selected mode.	Release key. Select valid operations depending on mode.
Secondary Display Toggles Continuously between Calibration Standard Values	Calibration error	Incorrect calibration solution used or contamination of calibration solution occurring in automatic calibration mode	Check if the right calibration solution was selected or use fresh calibration solution.
Battery icon lights up	Low Battery	Battery power is low	Replace batteries with fresh ones as soon as possible.

12 TROUBLE SHOOTING

Problem	Cause	Solution
No display when 'ON' key is pressed	<ul style="list-style-type: none"> a) Batteries not in place b) Batteries not in correct polarity (+ and – position) c) Weak batteries d) No AC power to adapter (if this optional accessory is used) 	<ul style="list-style-type: none"> a) Check that batteries are in place and making good contact b) Re-insert batteries with correct polarity c) Replace batteries d) Check power to AC adapter
Unstable readings	<ul style="list-style-type: none"> a) Air bubbles in electrode. b) Dirty electrode c) Electrode not deep enough in sample d) External noise pickup or induction caused by nearby electric motor e) Electrode guard not attached 	<ul style="list-style-type: none"> a) Tap electrode to remove bubbles, move electrode away from bubbles is present in sample b) Clean the electrode and re-calibrate c) Make sure sample entirely covers the electrode sensors d) Move or switch off interfering motor. e) Attach electrode guard
Slow response	<ul style="list-style-type: none"> a) Dirty / Oily electrode 	<ul style="list-style-type: none"> a) Clean electrode. See "Electrode Care & Maintenance", page 65
Meter is not responding to key press.	<ul style="list-style-type: none"> a) HOLD mode in operation 	<ul style="list-style-type: none"> a) Press the HOLD/ENTER key to cancel the HOLD mode
ATC indicator blinks and temperature display shows "Ur"	<ul style="list-style-type: none"> a) Improper attachment of electrode to the meter b) electrode built-in temperature sensor cable connection has broken 	<ul style="list-style-type: none"> a) Check that the electrode connects properly to the meter b) Replace electrode

13 LIST OF ACCESSORIES

13.1 Replacement Meter and Meter accessories

Description	Eutech Instruments Ordering Code	Oakton Instruments Ordering Code
CyberScan CON 11 Hand-held conductivity /TDS meter complete with conductivity electrode of K=1.0 (EC-CONSEN91W/ 35608-50).	EC-CON11/03	35607-40
CyberScan CON 11 Hand-held conductivity /TDS meter complete with conductivity electrode of K=1.0 (EC-CONSEN91W) in rugged hard-plastic carrying case kit (EC-CONWPKIT/ 35632-98).	EC-CON11/03K	35607-80
CyberScan CON 110 Hand-held conductivity/TDS meter with RS232C cable (EC-CA01M09F09), software and complete with conductivity electrode of K=1.0 (EC-CONSEN91W/ 35608-50).	EC-CON110/03	35607-45 (35615-09 RS232 cable not included)
CyberScan CON 110 Hand-held conductivity/TDS meter with RS232C cable (EC-CA01M09F09), software and complete with conductivity electrode of K=1.0 (EC-CONSEN91W/ 35608-50) in rugged hard-plastic carrying case kit (EC-CONWPKIT/ 35632-98).	EC-CON110/03K	35607-85 (35615-09 RS232 cable not included)
2 stainless steel rings, Ultem-body Electrode with ATC, Cell Constant K = 1.0	EC-CONSEN91W	35608-50
2 platinum rings, Epoxy-body Electrode with ATC, Cell Constant K= 0.1	EC-CONSEN72W	35608-55
2 platinum rings, Epoxy-body Electrode with ATC, Cell Constant K= 10.0	EC-CONSEN73W	35608-51
Carrying pouch for portable meter	EC-POUCH02	35615-75
Replacement 16-mm electrode holder	EC-15X000702	00132-LK
Meter to PC communication cable – 9-pin male to 9-pin female connector, 1-m cable length.	EC-CA01M09F09	35615-09

13.2 Calibration Solutions

Description	Eutech Instruments Ordering Code	Oakton Instruments Ordering Code
1,413 μ S KCl Calibration Solution in 480-ml leak-proof bottle	EC-CON-1413BT	00653-18
12.88 mS KCl Calibration Solution in 480-ml leak-proof bottle	EC-CON-1288BT	00606-10
2,764 μ S KCl Calibration Solution in 480-ml leak-proof bottle	EC-CON-2764BT	00653-20
10 μ S conductivity standard sachet, 20 ml x 20 pcs	EC-CON-10BS	35653-09
447 μ S Conductivity Sachets (20 units x 20 ml per box)	EC-CON-447BS	35653-10
1,413 μ S Conductivity Sachets(20 units x 20 ml per box)	EC-CON-1413BS	35653-11
2,764 μ S Conductivity Sachets(20 units x 20 ml per box)	EC-CON-2764BS	35653-12

Note: Conductivity standard solutions have $\pm 1\%$ accuracy at 25°C. Sachets are individually sealed, single use pouch containing 20 ml of fresh, contamination free calibration solution. Conductivity sachets have $\pm 1\%$ accuracy at 25°C.

14 FACTORY DEFAULT SETTINGS

14.1 CON 11 Factory Default Setting

PROGRAM	FUNCTION	PARAMETER OPTING KEYS	PARAMETER OPTIONS	DEFAULT SETTING
P 1.0	Unit Configuration	<i>Parameter Title Only</i>	<i>Parameter Title Only</i>	
P 1.1	Selection of READY Indicator	MI/▲; MR/▼	ON ; OFF,	ON
P 1.2	°C indicator	<i>Viewing only</i>	<i>Viewing only</i>	°C
P 1.3	Selection of Automatic or Manual Temperature Compensation	MI/▲; MR/▼	YES, nO	YES
P 1.4	Selection of TDS Conversion Factor	MI/▲; MR/▼	0.40 to 1.00	0.50
P 2.0	Viewing previous calibration data	<i>Parameter Title Only</i>	<i>Parameter Title Only</i>	
P 2.1	First range calibration point	<i>Viewing Only</i>	<i>Viewing Only</i>	---
P 2.2	Second range calibration point	<i>Viewing Only</i>	<i>Viewing Only</i>	---
P 2.3	Third range calibration point	<i>Viewing Only</i>	<i>Viewing Only</i>	---
P 2.4	Fourth range calibration point	<i>Viewing Only</i>	<i>Viewing Only</i>	---
P 2.5	Fifth range calibration point	<i>Viewing Only</i>	<i>Viewing Only</i>	---
P3.0	Viewing electrode data	<i>Parameter Title Only</i>	<i>Parameter Title Only</i>	
P3.1	Effective cell constant for first range	<i>Viewing Only</i>	<i>Viewing Only</i>	K = "1.00"
P3.2	Effective cell constant for second range	<i>Viewing Only</i>	<i>Viewing Only</i>	K = "1.00"
P3.3	Effective cell constant for third range	<i>Viewing Only</i>	<i>Viewing Only</i>	K = "1.00"
P3.4	Effective cell constant for fourth range	<i>Viewing Only</i>	<i>Viewing Only</i>	K = "1.00"
P3.5	Effective cell constant for fifth range	<i>Viewing Only</i>	<i>Viewing Only</i>	K = "1.00"
P4.0:	Auto Power OFF	MI/▲; MR/▼	YES, nO	YES
P5.0	Reset to factory defaults	<i>Parameter Title Only</i>	<i>Parameter Title Only</i>	
P5.1	Resetting of all calibration and clear all calibration data	MI/▲; MR/▼	nO, YES	nO
P5.2	Resetting of all User settings to factory defaults condition	MI/▲; MR/▼	nO, YES	nO
P6.0	Memory clear	MI/▲; MR/▼	nO, YES	nO
P7.0	Temperature	<i>Parameter Title Only</i>	<i>Parameter Title Only</i>	
P7.1	Setting of temperature coefficient	MI/▲; MR/▼	0.0 to 10.0	2.1
P7.2	Setting of normalisation temperature	MI/▲; MR/▼	20.0 & 25.0	25.0
P8.0	Selection of cell constant	MI/▲; MR/▼	1.0, 10.0, 0.1	K = "1.0"
P9.0	Automatic Single Point Calibration	<i>Parameter Title Only</i>	<i>Parameter Title Only</i>	
P9.1	Selection of Automatic or Manual Calibration	MI/▲; MR/▼	YES, nO	"YES"
P9.2	Selection of Single or Multi Point Calibration	MI/▲; MR/▼	YES, nO	"YES"

NOTE: The HOLD/ENTER key is used to confirm every parameter opted. The CAL/MEAS on the other hand will escape the set up operation to return to the measurement mode.

14.2 CON 110 Factory Default Setting

PROGRAM	FUNCTION	PARAMETER OPTING KEYS	PARAMETER OPTIONS	DEFAULT SETTING
P 1.0	Unit Configuration	<i>Parameter Title Only</i>	<i>Parameter Title Only</i>	
P 1.1	Selection of READY Indicator and Auto HOLD Function	MI/▲; MR/▼	ON ; OFF, HOLD	ON
P 1.2	Selection of °C and °F indicator	MI/▲; MR/▼	°C, °F	°C
P 1.3	Selection of Automatic or Manual Temperature Compensation	MI/▲; MR/▼	YES, nO	YES
P 1.4	Selection of TDS Conversion Factor	MI/▲; MR/▼	0.40 to 1.00	0.50
P 2.0	Viewing previous calibration data	<i>Parameter Title Only</i>	<i>Parameter Title Only</i>	
P 2.1	First range calibration point	<i>Viewing Only</i>	<i>Viewing Only</i>	----
P 2.2	Second range calibration point	<i>Viewing Only</i>	<i>Viewing Only</i>	----
P 2.3	Third range calibration point	<i>Viewing Only</i>	<i>Viewing Only</i>	----
P 2.4	Fourth range calibration point	<i>Viewing Only</i>	<i>Viewing Only</i>	----
P 2.5	Fifth range calibration point	<i>Viewing Only</i>	<i>Viewing Only</i>	----
P3.0	Viewing electrode data	<i>Parameter Title Only</i>	<i>Parameter Title Only</i>	
P3.1	Effective cell constant for first range	<i>Viewing Only</i>	<i>Viewing Only</i>	K = "1.00"
P3.2	Effective cell constant for second range	<i>Viewing Only</i>	<i>Viewing Only</i>	K = "1.00"
P3.3	Effective cell constant for third range	<i>Viewing Only</i>	<i>Viewing Only</i>	K = "1.00"
P3.4	Effective cell constant for fourth range	<i>Viewing Only</i>	<i>Viewing Only</i>	K = "1.00"
P3.5	Effective cell constant for fifth range	<i>Viewing Only</i>	<i>Viewing Only</i>	K = "1.00"
P4.0:	Auto Power OFF	MI/▲; MR/▼	YES, nO	YES
P5.0	Reset to factory defaults	<i>Parameter Title Only</i>	<i>Parameter Title Only</i>	
P5.1	Resetting of all calibration and clear all calibration data	MI/▲; MR/▼	nO, YES	nO
P5.2	Resetting of all User settings to factory defaults condition	MI/▲; MR/▼	nO, YES	nO
P6.0	Memory clear	MI/▲; MR/▼	nO, YES	nO
P7.0	Temperature	<i>Parameter Title Only</i>	<i>Parameter Title Only</i>	
P7.1	Setting of temperature coefficient	MI/▲; MR/▼	0.0 to 10.0	2.1
P7.2	Setting of normalisation temperature	MI/▲; MR/▼	20.0, 25.0	25.0
P8.0	Selection of cell constant	MI/▲; MR/▼	1.0, 10.0, 0.1	K = "1.0"
P9.0	Automatic Single Point Calibration	<i>Parameter Title Only</i>	<i>Parameter Title Only</i>	
P9.1	Selection of Automatic or Manual Calibration	MI/▲; MR/▼	YES, nO	YES
P9.2	Selection of Single or Multi Point Calibration	MI/▲; MR/▼	YES, nO	YES

NOTE: The HOLD/ENTER key is used to confirm every parameter opted. The CAL/MEAS on the other hand will escape the set up operation to return to the measurement mode.

15 SPECIFICATIONS

SPECIFICATIONS	CON 11	CON 110
Conductivity Range	0 to 19.99 $\mu\text{S/cm}$, 20.0 to 199.9 $\mu\text{S/cm}$, 200 to 1999 $\mu\text{S/cm}$; 2.00 to 19.99 mS/cm , 20.0 to 199.9 mS/cm	0 to 19.99 $\mu\text{S/cm}$, 20.0 to 199.9 $\mu\text{S/cm}$, 200 to 1999 $\mu\text{S/cm}$; 2.00 to 19.99 mS/cm , 20.0 to 199.9 mS/cm
TDS Range	0.00 to 9.99 ppm 10.0 to 99.9 ppm 100 to 999 ppm; 1.00 to 9.99 ppt 10.0 to 99.9 ppt	0.00 to 9.99 ppm 10.0 to 99.9 ppm 100 to 999 ppm; 1.00 to 9.99 ppt 10.0 to 99.9 ppt
Resolution	0.05 % Full Scale	0.05 % Full Scale
Accuracy	$\pm 1\%$ F.S. +1 digit	$\pm 1\%$ F.S. +1 digit
Temperature Range	-10.0 to 110.0°C	-10.0 to 110.0°C (14.0 to 230 °F)
Temperature Resolution °C	0.1 °C	0.1 °C
Temperature Resolution °F	Not available	0.1 °F(from 14.0°F to 199.9°F) & 1.0°F(from 200°F to 230°F)
Temperature Accuracy	± 0.5 °C	± 0.5 °C (± 0.9 °F)
Cell Constant, K	0.1, 1.0, 10.0 (Selectable)	0.1, 1.0, 10.0 (Selectable)
Temperature Compensation	Automatic / Manual (from 0 to 100°C)	Automatic / Manual (from 0 to 100°C)
Temperature Coefficient	0.0 to 10.0% / ° C	0.0 to 10.0% / ° C
Normalisation Temperature	20.0 or 25.0°C	20.0 or 25.0°C
TDS Factor	0.40 to 1.00	0.40 to 1.00
Calibration Points (Automatic)	84.0, 1413 $\mu\text{S/cm}$; 12.88, 111.8 mS/cm	84.0, 1413 $\mu\text{S/cm}$; 12.88, 111.8 mS/cm
Calibration Points (Manual)	User defined standard / 1 per range up to 5 points.	User defined standard / 1 per range up to 5 points.
Single/Multi point calibration	Selectable	Selectable
Calibration Range	10% to full scale	10% to full scale
Auto-ranging	Yes (manual select available)	Yes (manual select available)
HOLD Function	Yes	Yes
Memory	50 Data Sets	100 Data Sets
Auto Off	Selectable	Selectable
Auto Off Time	20 minutes after last key operation	20 minutes after last key operation

Auto HOLD function	Not available	Selectable
Averaging/Stability (READY)	Selectable	Selectable
Inputs	6-pin connector, power jack	6-pin connector, power jack
Output	No	RS232C
Ambient Temperature Operating Range	0 to 50 °C	0 to 50 °C
Display	Custom Dual LCD	Custom Dual LCD
Power Requirements	4 'AAA' Batteries	4 'AAA' Batteries
AC/DC Adapter ratings	I/P Voltage range 9 to 15V, Current rating 200 mA	I/P Voltage range 9 to 15V, Current rating 200 mA
Battery Life	> 200 hours (Alkaline Batteries)	> 200 hours (Alkaline Batteries)
Dimension / Weight	Meter: 18 x 9 x 4 cm; 290 g Boxed: 24 x 23 x 7 cm; 650 g Case34 x40 x 10 cm 2.2 kg	Meter: 18 x 9 x 4 cm; 290 g Boxed: 24 x 23 x 7 cm; 650 g Case34 x40 x 10 cm 2.2 kg

16 CALIBRATION TIPS

You only need one calibration for measurement throughout the entire range of the meter. If a range was not calibrated, the meter automatically detects the closest range calibrated and uses that calibration information. However, only the ranges that were calibrated have maximum accuracy.

If you are measuring in ranges near to or greater than 20 mS (10 ppt), or near to or lower than 100 μ S (50 ppm), calibrate the meter at least once a week to get specified $\pm 1\%$ F.S. accuracy.

If you are measuring in the mid-ranges and you washed the electrode in de ionised water and stored it dry, calibrate the meter at least once a month.

Wet the electrode for 10 minutes before calibrating or taking readings to saturate the electrode surface and minimise drift. If you make measurements at extreme temperatures, calibrate the meter at least once a week.

You should only use the conductivity / TDS electrode specified for these meters. These electrodes have a built-in temperature sensor. If you use a different electrode without a temperature sensor, you must measure the solution temperature separately and manually enter the solution temperature (see manual temperature compensation section on page 21).

17 CALCULATING TDS CONVERSION FACTORS

You can calibrate your meter using TDS calibration standard solutions. The calibration standard only needs to give the TDS value at a standard temperature such as 25 °C. To determine the conductivity-to-TDS conversion factor use the following formula:

$$\text{Factor} = \text{Actual TDS} \div \text{Actual Conductivity @ 25 } ^\circ\text{C}$$

Definitions:

Actual TDS: Value from the solution bottle label or as a standard you make using high purity water and precisely weighed salts.

Actual Conductivity: Value measured using a properly calibrated Conductivity / Temperature meter.

Both the Actual TDS and the Actual Conductivity values must be in the same magnitude of units. For example, if the TDS value is in ppm the conductivity value must be in μ S; if the TDS value is in ppt the conductivity value must be in mS.

Check your meter factor by multiplying the conductivity reading by the factor in the above formula. The result should be in TDS value.

18 CALCULATING TEMPERATURE COEFFICIENTS

To determine the temperature coefficient of your sample solution use this formula:

$$tc = 100 \times \frac{C_{T_2} - C_{T_1}}{C_{T_1}(T_2 - 25) - C_{T_2}(T_1 - 25)}$$

Where:

tc = Temperature coefficient **25** = 25 °C

C_{T1} = Conductivity at Temp 1 **C_{T2}** = Conductivity at Temp 2

T₁ = Temp 1 **T₂** = Temp 2

NOTE: A controlled temperature water bath is ideal for this procedure

1. Immerse the electrode into a sample of your solution and adjust the temperature coefficient to 0% (that is, no compensation) by performing the following:
2. From measurement mode, press the **SETUP** key to enter Setup menu.
3. Press the **MI/▲** or **MR/▼** key until the lower display reads P7.0.
4. Press the **HOLD/ENTER** key to display the temperature coefficient value.
5. Press the **MR/▼** key until the upper display shows 0.0.
6. Press **HOLD/ENTER** key to confirm the value.
7. Press **CAL/MEAS** key to return to measurement mode.
8. Wait for 5 minutes. Note **T₁** and **C_{T1}** (conductivity at **T₁**).
9. Condition the sample solution and electrode to a temperature (**T₂**) that is about 5 °C to 10 °C different from **T₁**, and note the conductivity reading **C_{T2}**.

NOTE: Record your results for future reference. Ideally **T₁** and **T₂** should bracket your measurement temperature, and should not differ by more than 5 °C.

10. Calculate the temperature coefficient of your solution using the formula shown above.
11. Enter the temperature coefficient you calculated into the meter by following the following steps.
12. From measurement mode, press the **SETUP** key to enter Setup mode.
13. Press the **MR/▼** key until the lower display reads P7.0.
14. Press the **HOLD/ENTER** key to show the temperature coefficient value (should be 0, as per step 1 above).
15. Press the **MI/▲** key until the upper display shows your calculated temperature coefficient.
16. Press **HOLD/ENTER** key to confirm the value.
17. Press **CAL/MEAS** key twice to return to measurement mode.

The calculated temperature coefficient will not be applied to all the meter readings.

19 WARRANTY

This meter is supplied with a three-year warranty, six-month warranty for electrode against significant deviations in material and workmanship.

If repair or adjustment is necessary and has not been the result of abuse or misuse within the designated period, please return – freight pre-paid – and correction will be made without charge. Eutech Instruments/ Oakton Instruments will determine if the product problem is due to deviations or customer misuse.

Out of warranty products will be repaired on a charged basis.

Exclusions

The warranty on your instrument shall not apply to defects resulting from:

- Improper or inadequate maintenance by customer
- Unauthorised modification or misuse
- Operation outside of the environment specifications of the products

20 RETURN OF ITEMS

Authorisation must be obtained from our Customer Service Department or authorised distributor before returning items for any reason. A “Return Goods Authorisation” (RGA) form is available through our Authorised Distributor. Please include data regarding the reason the items are to be returned. For your protection, items must be carefully packed to prevent damage in shipment and insured against possible damage or loss. Eutech Instruments/ Oakton Instruments will not be responsible for damage resulting from careless or insufficient packing. A restocking charge will be made on all unauthorised returns.

NOTE:

Eutech Instruments Pte Ltd/ Oakton Instruments reserve the right to make improvements in design, construction, and appearance of products without notice.