

RTC^t-168

Reference Temperature Calibrator

- ▶ **Sanitary Sensor Calibration**
High-Speed, High-Volume Calibration
with Bath & Dry Block Combination
- Temperature range: -30 to 165°C/-22 to 329°F
Accuracy down to: $\pm 0.045^{\circ}\text{C}/\pm 0.081^{\circ}\text{F}$
with External Reference Sensor*



The RTCt: Your Sanitary Sensor Solution

The RTCt models usher in a new era of precision and user-centricity in temperature calibration by offering a comprehensive feature set meticulously designed to improve your workflows. Experience the easy intuitive navigation through the touchscreen interface. Wireless connectivity streamlines data transfer and facilitates remote monitoring while innovative graphical presentations enhance clarity and expedite analysis.

One of the technicians' most challenging calibration jobs is the sanitary sensors used predominately in the pharmaceutical and food and beverage industries. To accurately calibrate these sensors, the sensing element must be in the uniform zone of the temperature calibrator. This is often challenging due to the small length of the sanitary sensor or the large flange above the sensor.

At AMETEK STC, we have worked closely with our customers to understand these difficulties, and we are pleased to offer a solution with our RTCt-168 Reference Temperature Calibrator.

The RTCt-168 stands out with its unique bath and dry block combination, providing unmatched flexibility for various calibration needs. Furthermore, the RTCt series represents the most accurate dry blocks on the market, setting a new benchmark for precision in temperature calibration - all combined in a safe, portable package.



Advanced Touchscreen Display: Provides a highly intuitive navigation, with operation and all relevant data at your fingertips. Experience clear numerical values, step-by-step instructions, and graphical representations that elevate your calibration process.

Wireless Connectivity: Experience seamless data access and sharing. Monitor, control, and analyze calibration data in real-time through a web browser interface, from anywhere in your facility or even remotely. This wireless functionality reduces the need to be physically present at the calibrator, saving time and ensuring an efficient calibration processes.

Two Sensor Under Test Inputs: With the ability to simultaneously calibrate two sensors, the RTCt-168 offers a comprehensive solution for even complex calibrations effectively doubling the calibration capacity per run.

Highly Accurate Liquid Calibration System: A redesigned liquid calibration system and a faster magnetic stirrer result in a longer temperature uniformity zone. This vertically extended zone now makes it reachable for shorter sanitary sensors.

Supports Large Flange Sizes: Supports calibration of sanitary sensors with diameters up to 84 mm.

Removable Liquid Container: The RTCt-168 features a removable liquid insert/container, making switching from wet to dry easier, faster, and much cleaner. Remove the container with liquid, and it's a dry-block calibrator again... No cleaning needed and much safer!

Special Sanitary Sensor Dry-Block Insert: For those customers who prefer to calibrate their sanitary sensors with a dry-block calibrator, we designed a special insert to accommodate short sensors.

New IP68 Interchangeable Reference Sensor: Our new STS-102A-035 reference sensor matches the RTC-168 temperature range, but more importantly is compatible with both dry and wet applications.

Enhanced Efficiency, Time, and Sustainability: Compared to the previous JOFRA RTC-168 model, the RTCt-168 features shorter cooling times, reducing the overall operational time needed for each calibration. This, along with lower power consumption, minimizes energy usage and optimizes performance.

Optimized Calibration Workflows

The RTCt temperature calibrator prioritizes user experience through innovative features that streamline workflows and empower technicians.

User-Defined Setpoints for Streamlined Calibration

The RTCt provides enhanced control over your calibration process with its user-defined setpoint functionality. Define up to six custom temperature points to precisely match your specific sensor requirements. This eliminates the need for repetitive re-entries of often used calibration temperatures, streamlining workflow and maximizing efficiency.

User-Configurable Interface for Optimized Workflow

The RTCt surpasses traditional interfaces by offering a simple user experience that adapts to your workflow. Leveraging the selectable User Interface (UI) feature, it prioritizes the information most critical for your tasks, minimizing distractions and enhancing focus. Tailor the interface to your preferences, ensuring intuitive and effortless execution of each calibration step. This results in a personalized calibration process that seamlessly integrates with your existing workflow.

Intuitive Data Management for Effortless Retrieval

Eliminate confusion from generic labels by implementing a system that reflects your unique calibration procedures. Assign meaningful names to your data sets, enabling effortless searching and retrieval. Say goodbye to time-consuming data mining and streamline your calibration workflow with the RTCt's intuitive data management capabilities.



Enhanced Connectivity and Wireless Capabilities

Unrestricted Calibration from Anywhere

The RTCt temperature calibrator's wireless connectivity empowers you to calibrate with unprecedented freedom and flexibility. With Wi-Fi capabilities, you can monitor and analyze calibration data in real-time through a web browser interface, from anywhere in your facility or even remotely. This wireless functionality reduces the need to be physically present at the calibrator, saving time and ensuring efficient calibration processes.

Remote Management via Web Interface

For wireless connectivity, the RTCt-168 includes a Wi-Fi dongle, allowing cable-free operation and remote access. This Wi-Fi connection enhances workflow automation, reduces setup constraints, and ensures seamless integration into your calibration environment.

Enhance Versatility through Diverse Communication Standards

The RTCt caters to various connectivity needs by supporting a wide range of communication standards, including Wi-Fi, Ethernet, and USB. This comprehensive offering ensures seamless integration with existing systems, regardless of their communication protocol.

Simplified Integration with User-Friendly Communication Protocols

Seamlessly integrate the RTCt into your existing systems with open communication protocols, ensuring flexibility across industries such as pharmaceutical, food & beverage, energy, and manufacturing. The RTCt supports ASCII-based protocol, making integration effortless across various platforms.

By offering open protocols, the RTCt eliminates compatibility challenges, allowing for smooth automation, remote control, and data exchange with external systems.



The Wi-Fi dongle is standard equipment in all RTCt's

Sanitary sensor and Dual-Input Calibration

In today's demanding industrial landscape, accurate and efficient temperature calibration is crucial for ensuring the reliability and safety of processes. The RTCT-168 redefines calibration standards with its dual-sensor capabilities, removable liquid container, and expanded sensor support.



Dual-Sensor Input for Parallel Calibration

The RTCT-168 empowers users to simultaneously calibrate two sensors, boosting efficiency and productivity. This dual-input system eliminates the need for sequential calibration, allowing for parallel processes that streamline workflows and reduce downtime.

Safe and Clean Calibration with Removable Liquid Container

The RTCT-168 is designed for safe and efficient calibration with its removable liquid container, enabling a seamless transition between wet and dry calibration. This innovative feature eliminates the need for extensive cleaning – simply remove the liquid container, and the calibrator is ready for dry-block calibration.

For maximum safety, the container is equipped with a screw-on lid and built-in pressure relief valve, ensuring secure handling and transportation. This design prevents spills of hot or hazardous liquids, minimizing risk to the user and the work environment. Whether dealing with high-temperature or potentially hazardous substances, the RTCT-168 offers a clean, safe, and user-friendly calibration experience.

Accommodate Diverse Sensor Sizes with Expanded Sensor Support

The calibrator supports the calibration of sanitary sensors with diameters up to 84 mm, providing users with increased flexibility in handling diverse sensor sizes. This expansion caters to the evolving needs of industries relying on temperature-sensitive processes, ensuring compatibility with a wide range of sensor dimensions.

Dedicated Sanitary Sensor Insert

Catering to customer preferences, the RTCT-168 offers a special insert for calibrating sanitary sensors using a dry-block method. The RTCT-168's dedicated sanitary sensor insert eliminates the need for cumbersome adapters or multiple calibrators. This streamlined approach simplifies the calibration process, saving time and effort. Short sensors are accommodated seamlessly, and adapters for different models are also available, offering a tailored calibration solution.

Temperature Control and Sensor Protection

The RTCt-168 elevates temperature calibration capabilities through a combination of innovative design elements and improved functionalities. These advancements culminate in superior uniformity, broader applicability, and meticulous control over the calibration process.

Accelerated Magnetic Stirring

Building on the success of its predecessor, the RTCt-168 incorporates a redesigned liquid calibration system with an accelerated magnetic stirrer. The result is an extended temperature uniformity zone, particularly beneficial for shorter sanitary sensors. This enhancement ensures precise and reliable calibration across a broader range of sensor types.

Reversed Airflow System for Sensor Protection

In an industry-first, the RTCt-168 employs a reversed airflow system, expelling hot air from the bottom of the calibrator rather than the top. This innovative design shields the sensors under test from heated exhaust air, preserving their integrity during calibration processes and ensuring long-lasting performance.

Automatic Temperature Switch Test for Adaptable Calibration

The automatic temperature switch test has been meticulously refined for superior performance. With the RTCt, users can execute 1 to 5 test runs, offering flexibility and adaptability to various calibration scenarios while maintaining an unprecedented level of precision.

Improved Rate Control for Precise Temperature Adjustments

The RTCt introduces enhanced rate control across all modes, ensuring precise temperature adjustments. This upgrade empowers users with greater control over the calibration process, guaranteeing accurate and consistent results.



Redefining Precision and Intuitiveness: Unveiling the RTC^t Temperature Calibrator's Touch Screen User Interface

In a groundbreaking stride toward user-centric innovation, we are thrilled to introduce the RTC^t Temperature Calibrator's all-new Touch Screen User Interface. This cutting-edge interface marks a pivotal moment in temperature calibration technology, seamlessly merging precision with unparalleled intuitiveness. Designed with user experience at its core, the RTC^t's touch screen interface heralds a new era in temperature calibration, promising a more accessible, efficient, and user-friendly calibration process. Let's explore the transformative features that make this touch screen interface a game-changer for professionals in the field.

The RTC^t startup menu provides a simple and user-friendly interface, ensuring quick access to essential functions. Users can effortlessly select between: Calibration / Auto Calibration / Switch Test / Auto Step.

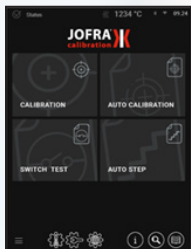

The RTC^t main screen provides a clear, real-time view of the ongoing calibration with live progress, setpoints, and stability indicators. The patent-pending intuitive graph dynamically adjusts for enhanced precision and deviation detection. Learn more on the [next page](#).

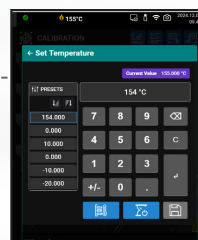

Easily set and manage calibration temperatures with six customizable presets for quick selection. Effortlessly prepare and store temperature settings for future use. The controller ON/OFF function provides seamless control, ensuring efficient operation and precision.

The RTC^t UI ensures a clear and intuitive input experience, with available input options highlighted in green and unavailable selections greyed out, eliminating any risk of incorrect connections.

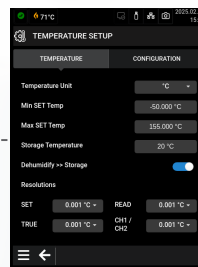
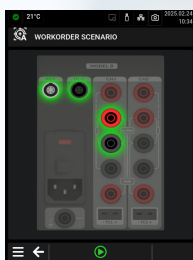

Easily configure system, temperature, and communication settings with an intuitive interface. The save/restore function allows quick setup adjustments and effortless retrieval of preferred configurations.



Patent Pending

RTC^t Series – Reliable Calibration with Complete Peace of Mind

See Every Detail. Trust Every Result. Calibrate with Confidence.

When precision matters, you need more than just numbers – you need visual proof that your calibration is accurate, stable, and reliable. The RTC^t Series Temperature Calibrators provide real-time dynamic graphing and patented innovations that make it easier than ever to verify accuracy, detect deviations, and ensure full compliance.

Exclusive Real-Time Calibration Graph – Patent Pending

Traditional calibrators can plot temperature over time, but they don't adapt dynamically. The RTC^t Series introduces the first-ever real-time graphing system that adjusts automatically based on calibration stability.

- **Instant Overview of the Calibration Process:** The calibration process begins with a broad full-cycle graph, which provides a clear, real-time view of your calibration's progression, helping users track temperature trends at a glance.
- **Setpoint Reference Line:** A dedicated line marks your set temperature, so you can instantly see when the calibrator reaches and maintains stability.
- **Automatic Precision Mode for Unmatched Visibility:** Once the calibrator reaches the setpoint and meets the stability criteria, the RTC^t's graph intelligently shifts to a high-resolution relative view, magnifying even the smallest deviations. **Patent Pending feature.**
- **Unmatched Deviation Visibility:** The relative graph magnifies even the smallest variations, making it possible to detect tiny fluctuations that are otherwise difficult to see.
- **Patent-Pending Technology:** Only in RTC^t – No other calibrator dynamically adjusts its graph based on calibration stability, giving you unrivaled visual confidence in your results.
- **Customizable Display:** All blue icons at the top of the screen can be easily toggled on or off, allowing users to focus only on the most relevant calibration data. This flexibility ensures a clutter-free interface tailored to individual workflows.
- **Seamless Documentation:** With a single tap of the print screen button, all on-screen information is instantly documented, preserving calibration data and highlighting even the most minute fluctuations for post-analysis.

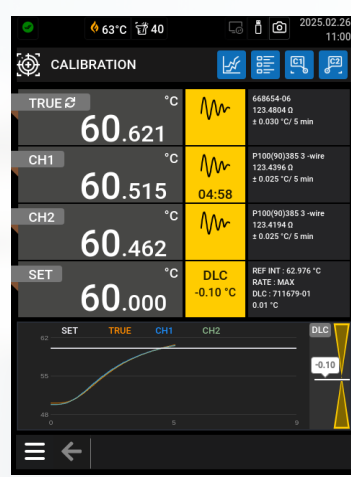

See the entire calibration process at a glance, with a clear setpoint reference line for easy stability monitoring.



Automatically zooms in on micro-deviations once stability is reached, ensuring unmatched accuracy and confidence.

Precision Switch Testing – Clear, Reliable, and Fully Documented

Temperature switches are critical for safety, system control, and process reliability. Ensuring they activate at the correct setpoints is essential to prevent false alarms, avoid equipment failures, and minimize costly downtime. The RTCt Series takes switch testing to the next level with an advanced, highly visual switch test display, delivering instant clarity, precision, and comprehensive documentation.

Switch Testing Made Clear and Reliable

■ Graph and Table Data on One Screen:

The RTCt displays both the switch test graph and the test results table simultaneously. The graph plots switch activation points over time, making it easy to detect drift, response delays, or anomalies. The table logs exact activation and deactivation temperatures, ensuring precise traceability.

■ Hysteresis & Repeatability Analysis:

Understanding switch behavior isn't just about activation temperature; it's also about how consistently it triggers under repeated cycles. The RTCt makes it simple to see:

Hysteresis – The difference between activation and reset points.

Switch consistency – Does it switch at the same temperature every time?

■ Documentation at the Push of a Button

With built-in print screen functionality, all displayed information—including graphs, test results, and activation trends—can be instantly documented for audits, compliance, and traceability.

The RTCt's advanced switch test display transforms temperature switch verification into a clear, reliable, and fully traceable process—helping users enhance safety, reduce downtime, and optimize operational efficiency.

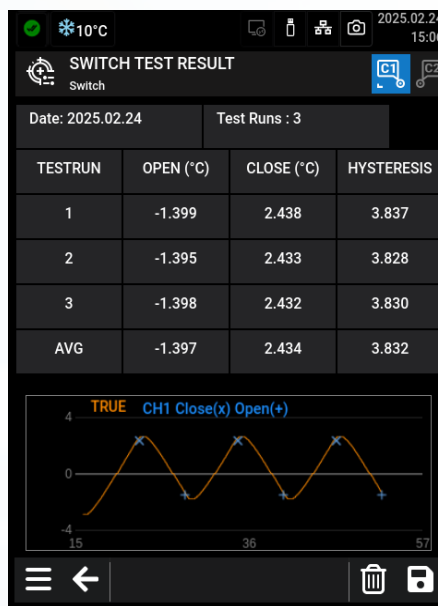

Track switch activation points with dynamic status indicators, a real-time graph, and precise test results—all in one clear, intuitive display.

Sanitary Sensor Calibration in Our Temperature Bath

Our new patent-pending temperature calibration technique allows users to calibrate large diameter, short sanitary sensors in situations that closely mirror the sensor's day-to-day use. By isolating the liquid in the main block from the excess liquid around the flange, we have removed the liquid flow effect and the need for a precise liquid level, two traditional sources of error. We have combined knowledge learned through our years of producing temperature calibrators with the feedback given by users in the field and created the industry's only portable temperature calibrator capable of high-accuracy wet calibrations of sanitary sensors up to 84 mm in diameter.

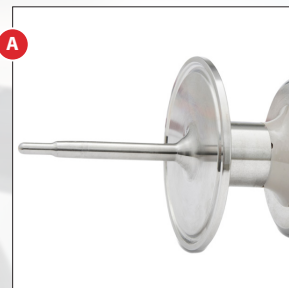
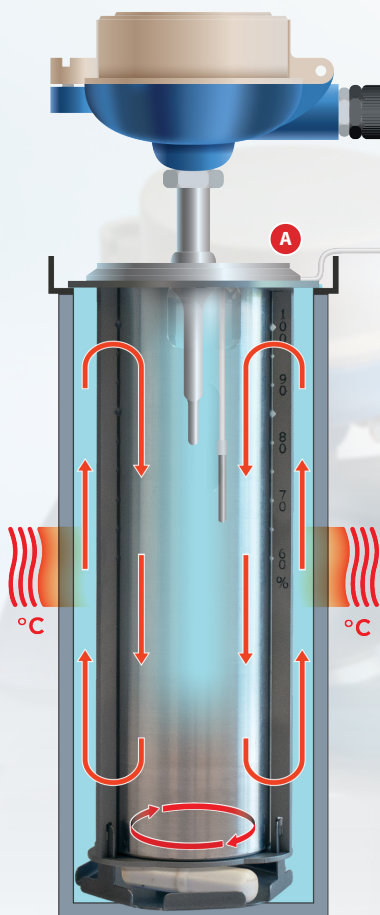

A newly designed, larger calibration surface allows the RTCT-168 to accept sanitary sensors with diameters up to 84 mm in diameter.

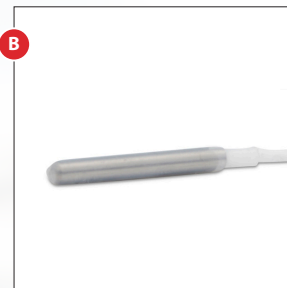

The new IP68 classified cable reference sensor (STS-102-A-035) fits under the sanitary sensor flange through a groove in the sensor basket.



The heat conveyor block (130237) isolates the liquid in the main block from the excess fluid around the flange.

The heat conveyor block transfers the heat from the calibrator to the sanitary sensor directly through the aluminum of the heat conveyor. This method creates a much more consistent heat transfer than the traditional method of transferring heat through the liquid.

Sanitary Sensor Calibration in the Dry-Block Configuration

For customers that prefer the speed and cleanliness of a dry-block calibrator, we offer solutions to help you calibrate sanitary sensors. It starts with a custom insert that includes a cable groove which allows users to slide our new STS-102 A 035 reference sensor under the flange of the sanitary sensor. Place the sanitary sensor into the middle of the insert, and you're ready to calibrate. As sanitary sensors and sensor tips are available in countless shapes and designs, we can design and produce special inserts and deliver a genuinely plug n' play sanitary sensor calibration system.



Sanitary Sensor and Insert.



STS-102 A 035 sensor in an insert.



STS-102 A 035 sensor and sanitary sensor in an insert, mounted in an RTCT-168 calibrator.



Once mounted, the RTCT-168 combines the external cable reference sensor and the built-in internal reference sensor to fuel its dual-zone technology and proven Set Follows True function to ensure consistent temperature from the main zone through the upper calibration zone. As technicians can easily transport the RTCT-168, they can now provide in-field calibration of difficult sanitary sensors.

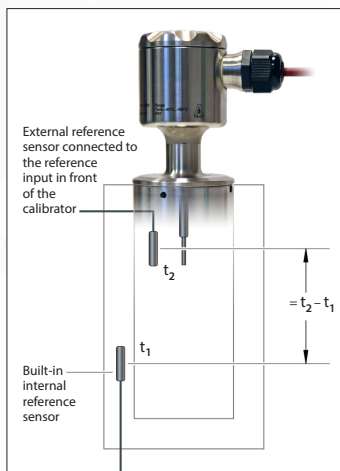

Set Follows True and dual-zone technology make dry sanitary sensor calibration possible.



Additional RTC^t-168 Dry-Block Features

Calibrating Large Sanitary Sensors

As sanitary sensors come in many shapes and sizes, the flange of the sensor can often create the biggest challenge for calibration technicians. If the diameter is too large, this may prevent the sensing element from reaching the ideal zone in the temperature calibrator.

The RTCt-168 solves this problem with the largest upper surface opening found in any JOFRA calibrator. The increased space now accepts sensor flanges up to 84 mm (24 mm more than our previous model), allowing the sensing element of the sensor to reach the calibration zone easily.

In addition to the large upper surface, the RTCt-168 includes a 160 mm (6.3") deep well with a diameter of 63.5 mm (2.5") – twice the size of any other dry-block. It is now possible to calibrate even more temperature sensors simultaneously and calibrate large and odd-shaped sensors inside the large well.



Assembled RTCt-156 insert and RTCt-168 adapter.

New Insert Adapter Supports Your Investment



RTCt-156 insert with RTCt-168 adapter
(130196).

For customers who are currently using our JOFRA ATC-156 & RTC-156, and RTCt-156 for their sanitary sensor calibrations, we have a solution that will save you money. Our new insert adapter allows you to slide your current ATC/RTCt-156 insert into the adapter, and then place the insert/adapter combination directly into the RTCt-168. This allows you to reuse your existing insert and avoid an additional cost.



Assembled RTCt-156 insert and RTCt-168 adapter.

Dry-Block and Liquid Temperature Bath Calibration

When considering their temperature calibration options, technicians often must decide between a dry-block calibrator and a liquid temperature bath. Each solution has distinct advantages over the other, and they also come with different drawbacks. But, with the RTCt-168, you don't have to decide. You can have the best of both worlds. And if that wasn't enough, our new liquid container makes switching from one to the other quick, safe, and clean.

Advantages of Liquid Calibration

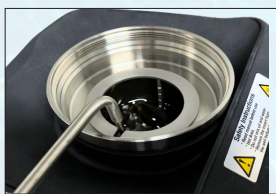

- You do not need inserts for the different types of sensors.
- You can calibrate sensors that wouldn't fit in an insert.
- You can calibrate glass thermometers and gas or liquid filled sensors.
- You can calibrate any type of odd shape sensor.

Advantages of Dry Calibration



- No hazardous or hot liquids.
- Easier to handle inserts rather than liquid.
- More convenient to carry a dry-block.
- No need for external exhaustion.
- 100% repeatability due to the fixed sensor position in the block.
- No oil contamination of the sensor under test.

Advantages of a Combined Liquid Bath/Dry Block Calibrator



- Can calibrate all sensors, whether they are long, short, odd-shaped, or flange mounted.
- Two calibrators in one.
- Full flexibility to choose between liquid and dry configurations as needed.
- Quickly switch between wet and dry to fit the application.

New Liquid Container

Although customers of our previous models enjoyed the flexibility of switching from dry-block to liquid bath modes, making this switch had its challenges, especially when switching from wet to dry. We listened to their feedback and created a new liquid container. Technicians can now pour their liquid into the container and place the container into the well. Once they complete their liquid test, simply remove the container from the well, and it's back to a dry-block. Or, if your lab uses multiple liquid types, keep a container for each type and switch back and forth as needed. It's a safer, cleaner, and easier solution, adding to the flexibility of the RTCt-168.

Please note that using the Container shall always be combined with using our STS External reference sensor and activating the Set Follows True function (SFT). Our B and C models include these features.



DLC – Dynamic Load Compensation. Making Dry Calibration Accurate and Well Documented

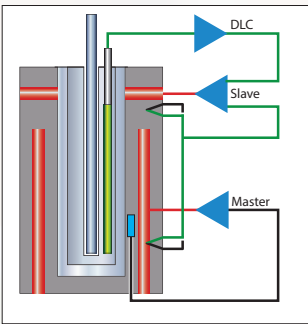

To bring our well documented active dual-zone technology to an even higher level, we have developed the patented DLC system.

This feature makes it possible to perform top calibration specifications without being affected by the actual load, e.g. many sensors or very big sensors.

The DLC sensor improves on the RTCt calibrator's already advanced dual-zone technology by controlling the homogeneity in not only the well, but inside the insert where the sensors-under-test are placed during calibration. The DLC sensor measures the temperature homogeneity in the insert and provides feedback to the active dual-zone system, which compensates the temperature difference to a minimum inside the insert. In this way, the DLC function makes the homogeneity independent of the different loads of the insert, making the RTCt the best performing dry-block calibrator on the market when calibrated and tested according to the globally accepted EURAMET Calibration Guide No. 13 Guideline on Calibration of Temperature Block Calibrators.

The DLC system is comprised of a special differential temperature sensor designed especially for the RTCt. The sensor is placed in the insert and connected to the calibrator. When the DLC function is enabled, the calibrator will automatically equalize the temperature homogeneity inside the insert, along with the normal temperature control and stabilization. **Note that DLC functionality can not be used when calibrating sanitary sensors.**

DLC – User Advantages

Calibrating with the DLC sensor offers the following advantages:

- 1 Calibration of several sensors simultaneously.
- 2 Calibration of thick sensors.
- 3 Gives TSL (Thermo Sensitive Length) independency. It is no longer necessary to know the TSL of the sensor.
- 4 Compensates for sensor production tolerances like the PT100 element being mounted in various positions in the sensor.
- 5 Trouble free calibration of sensors with PT100 elements up to 60 mm length.
- 6 The DLC indicator proves that the dual-zone is active and functioning well.
- 7 Proves that the calibrator is working perfectly. The DLC value should be very close to 0.00 when the calibrator is loaded with DLC sensor and an external reference sensor.
- 8 Together with the stability indication, the DLC indicates when the calibration values can be read.
- 9 JOFRA's unique, patented DLC system allows RTCt dryblock calibrators to perform with "close-to-laboratory" liquid bath performance.

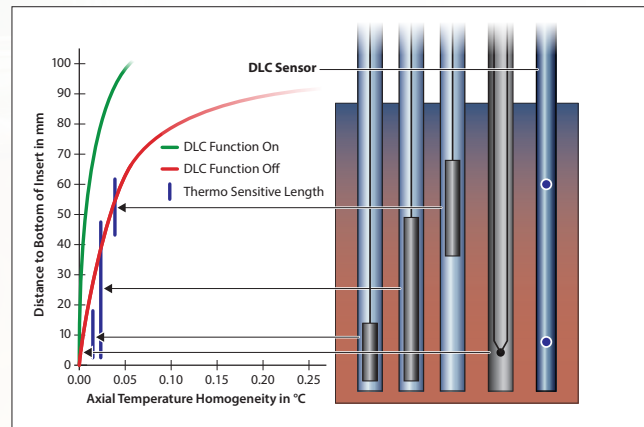

Axial temperature curves for an RTC calibrator with and without the DLC functionality activated.

Highest Accuracy Temperature Calibrator

Among the many features of the RTCt Series, one of the most important that our customers depend on is its high accuracy. Through years of innovation and patents, we have continued to solve challenges our customers face when calibrating a wide variety of temperature sensors.

Homogeneous Zones

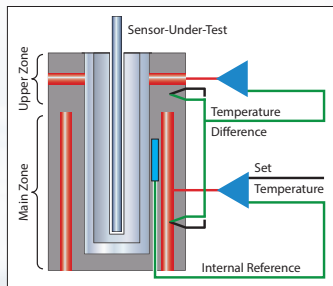

The RTCt series of calibrators provide precision temperature calibration of sensors, whatever the type or format. Our innovative active dual-zone heating technology independently controls each heating zone. This control produces two homogeneous zones, increasing the chances that the sensing element of the sensor-under-test will reach one of these ideal calibration zones. The lower zone ensures optimum heat dissipation throughout the entire calibration zone, while the upper zone compensates for heat loss from the sensor-under-test and the

open top. This design also eliminates the need for extra insulation of sensors-under-test and makes it possible to calibrate liquid-filled and other mechanical sensors.

Liquid Bath Kits

The sensor basket prevents sensors from interfering with the stirrer while also helping to create the largest possible temperature homogeneous zone. The sensor basket produces virtually zero axial and radial gradients in the calibration zone.



- Liquid Bath Kit 1, L1 (130403)**
- Sensor Basket with Temperature Equalizer Tube and Bottom Shield.
 - Lid with Safety Valve.
 - Covering/Insulation Plug.
 - Stirring Magnet (qty 3.)
 - Liquid Drainage Tube.
 - 0.75 liters of silicone oil 10.

Reference Sensors



We offer reference sensors that communicate directly with the RTCt to automate accurate calibrations for customers looking to provide an even more accurate system.

Our patented DLC system (when used in the dry-block configuration) takes the dual-zone heating technology a step further by controlling the homogeneity inside the insert where the sensors-under-test are. The result is a high accuracy calibration, no matter what size or how many sensors are in the insert.



In addition to the DLC, all JOFRA intelligent reference sensors contain the calibration data inside the sensor. Using these sensors removes a source of error



- Liquid Bath Kit 2, L2 (130508)**
- Everything Included in Kit 1.
 - Liquid Container.

Accessories and Supporting Products

We have a line of accessories and supporting products that further enhance the RTCt-168 temperature calibrator. These products provide options to pick and choose from depending on your application requirements. We have something to support almost any situation, from items that make calibrating and transporting easier to products that change and document the calibration process.

Important Accessories



Specialty Designed Carrying Case (127782)

It's more than just a rolling case. Our case includes compartments to store the STS and DLC sensors, the liquid container, inserts, insulation plugs, the support rod set, and tools. Perfect for your portable calibrator. Cat. no. 127782



Multi-Hole Inserts (see separate pages on inserts)

We offer two multi-hole inserts to fit almost any sensor diameter without buying numerous inserts. One for metric and one for imperial, our inserts include many sizes and room for reference and DLC sensors. [See page 19](#)



Integrated Support Rod (127277)

The integrated support rod helps to mount sensors under test. It is lightweight and mounts on two fixing holes integrated into the RTCt calibrator. Cat. no. 127277

Supporting Products

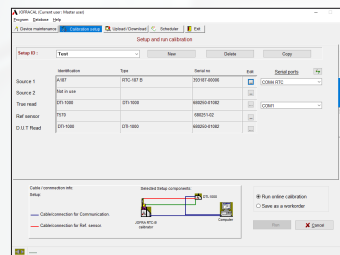

JofraCal Calibration Software

JofraCal is a highly versatile calibration software included with the RTCt calibrators. The software communicates with the RTCt to help ensure easy calibration of all kinds of temperature sensors, such as RTD's, thermocouples, transmitters, and thermostats.

JofraCal has a manual set-up that accepts user-entered data or an automatic mode that allows the RTCt to operate as a

stand-alone instrument with work orders. The software stores all completed calibration information on the computer for easy retrieval and printing.

For more information and details, [visit our JofraCal website here.](#)



JOFRA ASM Scanner

Using the JOFRA RTCt series together with the ASM, Advanced Signal Multi-scanner, offers a great time-saving automatic solution to calibrate multiple temperature sensors at the same time. The ASM series is an eight-channel scanner controlled by the JofraCal software on a PC. Up to 3 ASM units can be stacked to calibrate up to 24 sensors at a time. It can handle signals from 2-, 3- and 4 wire RTD's, thermocouples, transmitters, temperature switches, and voltage.

Specifications



Functional Specifications

Temperature Range

Dry and Liquid

@ ambient temp. 0°C/32°F -30 to 165°C/-22 to 329°F
 @ ambient temp. 23°C/73°F -30 to 165°C/-22 to 329°F
 @ ambient temp. 40°C/104°F -17 to 165°C/1.4 to 329°F

Liquid in Container

@ ambient temp. 0°C/32°F -30 to 160°C/-22 to 320°F
 @ ambient temp. 23°C/73°F -26 to 160°C/-15 to 320°F
 @ ambient temp. 40°C/104°F -13 to 160°C/8.6 to 320°F

Accuracy with External STS Ref. Sensor (models B and C)

In Insert *±0.045°C/±0.081°F
 In Insert **±0.070°C/±0.126°F
 In Bath *±0.045°C/±0.081°F
 In Bath **±0.060°C/±0.108°F
 In Bath in Container *±0.045°C/±0.081°F
 In Bath in Container **±0.060°C/±0.108°F

*12-month period. Relative to reference standard. Specifications by use of the external JOFRA STS-200 reference sensor.

**Total system accuracy, 12 months, incl. STS sensor and calibration uncertainty with accredited system calibration (RTCT-168 calibrator with STS 200 Reference sensor / ISO/EN/IEC 17025)

Accuracy with Internal Ref. Sensor (models A, B, and C)***

In Insert; Calibrated with Insert ±0.18°C/±0.32°F
 In Bath; Calibrated with Insert ±0.21°C/±0.38°F
 In Bath; Calibrated in Bath ±0.14°C/±0.25°F

***The specification does not include calibrating with the Liquid Container. Always use the STS External Reference Sensor connected to the calibrator when calibrating inside the Liquid Container.

Stability

Block, Bath, Bath in Container ±0.01°C/±0.018°F
 Measured after the stability indicator has been on for 15 minutes.
 Measuring time is 30 minutes

Resolution (user selectable)

All Temperatures 1° or 0.1° or 0.01° or 0.001°

Temperature Unit in Display

User Selectable °C, °F, or K

Radial Uniformity (difference between holes)

@ -30°C/-22°F, Block 0.02°C/0.04°F
 @ 165°C/329°F, Block 0.03°C/0.06°F
 @ -20 to 165°C/-4 to 329°F, Bath 0.015°C/0.03°F
 @ -30 to -20°C/-22 to -4°F, Bath 0.029°C/0.05°F

Heating Time

-30 to 23°C/-20 to 73°F 5 minutes
 23 to 100°C/73 to 212°F 10 minutes
 100 to 165°C/212 to 329°F 12 minutes

Cooling Time

165 to 100°C/329 to 212°F 12 minutes
 100 to 23°C/212 to 73°F 22 minutes
 23 to 0°C/73 to 32°F 13 minutes
 0 to -15°C/32 to 5°F 17 minutes
 -15 to -30°C/5 to -22°F 47 minutes

Time to Stability (approx.)

Block 30 minutes
 Bath 15 minutes
 Bath in Container 30 minutes

Physical Specifications

Weight and Instrument Size (LxWxH)

Weight 10.9 kg / 24.0 lb
 (LxWxH) 366 x 171 x 363 mm / 14.4 x 6.7 x 14.3 in

Shipping (without carrying case)

Weight 17 kg / 37.5 lb
 (LxWxH) 580 x 250 x 500 mm / 22.8 x 9.8 x 19.7 in

Shipping (including optional carrying case)

Weight 28 kg / 61.7 lb
 (LxWxH) 550 x 430 x 660 mm / 21.7 x 16.9 x 26.0 in

Shipping (Carrying case only)

Weight 12.7 kg / 28 lb
 (LxWxH) 550 x 430 x 660 mm / 21.7 x 16.9 x 26.0 in

Immersion Depth

Including insulation plug 180 mm / 7.1 in
 Bath version 150 mm / 5.9 in

Input Specifications

All input specifications apply to the dry-block of the calibrator running at the respective temperature (stable plus an additional 20 minute period). All input specifications are valid for the RTCT-168.

RTD Reference Input (models B and C)

Type 4-wire RTD with true ohm measurements⁽¹⁾
 F.S. (Full Scale) 400 ohm
 Accuracy (12 months) ±(0.0012% rdg. + 0.0005% F.S.)

RTD Type	Temperature		12 Months	
	°C	°F	°C	°F
Pt100(90)385 Reference	-30	-22	± 0.015	± 0.027
	0	32	± 0.016	± 0.028
	165	329	± 0.020	± 0.036

⁽¹⁾ True ohm measurement is an effective method to eliminate errors from induced thermoelectrical voltage.

DLC Sensor Input (models B and C)

TC diff	Temperature		12 Months	
	°C	°F	°C	°F
DLC-168	-30	-22	± 0.014	± 0.023
	0	32	± 0.012	± 0.020
	165	329	± 0.010	± 0.015

At 0.00°C/0.00°F DLC reading.



Specifications



RTD Sensor Under Test Input (model B)

F.S. (range) **400 ohm**
 Accuracy (12 months)..... **±(0.002% Rdg.+0.001% F.S)**
 F.S. (range) **4000 ohm**
 Accuracy (12 months)..... **±(0.003% Rdg. + 0.003% F.S.)**
 2-wire..... **add 50 mOhm**

RTD Type	Temperature		12 Months	
	°C	°F	°C	°F
Pt100(90)385	-30	-22	± 0.015	± 0.027
	0	32	± 0.016	± 0.028
	165	329	± 0.020	± 0.036
Pt500(90)385	-30	-22	± 0.068	± 0.122
	0	32	± 0.070	± 0.125
	165	329	± 0.078	± 0.140
Pt1000(90)385	-30	-22	± 0.038	± 0.067
	0	32	± 0.039	± 0.070
	165	329	± 0.046	± 0.082

Input and curves for many different resistance sensors such as:
 0-400Ω
 P10(90)386/P50(90)385/P100(90)385/P50(90)391/P100(90)391/
 P100(90)392/M50(90)428/M100(90)428/H120(90)672Pt-100 MILL
 0-4000Ω
 P200(90)385/P500(90)385/P1000(90)385/YSI-400

Thermocouple Input

Range **± 78 mV**
 F.S. (Full Scale)..... **78 mV**
 Accuracy (12 months) **±(0.005% Rdg. + 0.005% F.S.)**

TC Type	Temperature		12 Months*	
	°C	°F	°C	°F
E	-30	-22	± 0.08	± 0.13
	0	32	± 0.07	± 0.12
	165	329	± 0.07	± 0.12
J	-30	-22	± 0.09	± 0.15
	0	32	± 0.08	± 0.14
	165	329	± 0.08	± 0.15
K	-30	-22	± 0.11	± 0.19
	0	32	± 0.10	± 0.18
	165	329	± 0.11	± 0.20
T	-30	-22	± 0.12	± 0.20
	0	32	± 0.11	± 0.19
	165	329	± 0.09	± 0.16
R	-30	-22	± 0.89	± 1.60
	0	32	± 0.74	± 1.33
	165	329	± 0.47	± 0.85
S	-30	-22	± 0.85	± 1.53
	0	32	± 0.73	± 1.31
	165	329	± 0.49	± 0.88
N	-30	-22	± 0.16	± 0.29
	0	32	± 0.16	± 0.28
	165	329	± 0.13	± 0.24

* Excludes CJC accuracy ± 0.3° C / ± 0.54° F.

Transmitter Supply

Output Voltage **24VDC ±10%**
 Output Current **Maximum 28 mA**

Transmitter Input mA (model B)

Range **0 to 24 mA**
 Accuracy (12 months)..... **±(0.005% Rdg. +0.010% F.S.)**

Voltage Input VDC (model B)

Range **0 to 12 VDC**
 Accuracy (12 months)..... **±(0.005% Rdg. +0.010% F.S.)**

Switch Input (model B)

Switch Dry Contacts
 Test Voltage..... **Maximum 5 VDC**
 Test Current..... **Maximum 2.5 mA**

Mains Specifications

Voltage **115V (90-127) / 230V (180-254)**
 Frequency, non US Deliveries **50/60 Hz (47-63 Hz)**
 Frequency, US Deliveries **60 Hz (57-63 Hz)**
 Power Consumption (max.) **400 VA**

Communications Interface

Serial Data Interface..... **USB 2.0 Device Port**
 Serial Data Interface..... **USB 2.0 host, 3 ports***
 LAN..... **Ethernet MAC 10/100 Base-T***

Miscellaneous

Operating Ambient Temperature..... **0 to 40°C / 32 to 104°F**
 Storage Temperature..... **-20 to 50°C / -4 to 122°F**
 Humidity **0 to 90% RH**
 Protection Class..... **IP-10**



Specifications

Inserts

All inserts are supplied with a matching insulation plug, except for custom designed Sanitary Sensor inserts.

Insert Dimensions (Standard Insert)

Outer Diameter **63.5 mm / 2.5 in**
Length **160 mm / 6.3 in**

Insert Dimensions (Extended Sanitary Sensor Insert)

Outer Diameter **63.5 mm / 2.5 in**
Length **173 mm / 6.81 in**

Weight of Non-Drilled Insert (approx.)

Standard Insert **1200 g / 42.3 oz**
Extended Sanitary Sensor Insert **1300 g / 45.9 oz**

Alloy

Special Aluminum Alloy

Use of other inserts may reduce the performance of the calibrator. To get the best results out of the calibrator, the insert dimensions, tolerance, and material is critical. We highly advise using JOFRA inserts, as they guarantee trouble-free operation.

Undrilled Inserts

(Ø 63.5 mm; 160 mm length)

Inserts	Instrument
Undrilled Insert	RTCt-168
Undrilled Insert with DLC	130489
Undrilled Insert with DLC and reference sensor 4 mm and 1/4 in	130488
Undrilled Insert with DLC and reference sensor 4 mm and 1/4 in	130486

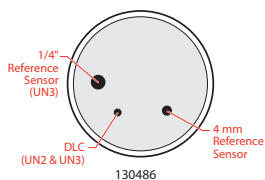

Metric (mm) Multi-hole Insert (Ø 63.5 mm; 160 mm length)

Inserts	Instrument
Metric Multi-Hole Insert	RTCt-168
Metric Multi-Hole Insert	130490

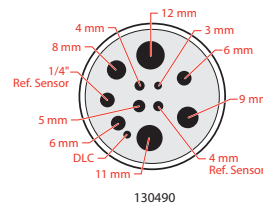

Imperial (in) Multi-hole Insert (Ø 63.5 mm; 160 mm length)

Inserts	Instrument
Imperial Multi-Hole Insert	RTCt-168
Imperial Multi-Hole Insert	130491

* Use the insert code, when ordering a JOFRA standard undrilled insert together with the RTCt calibrator.

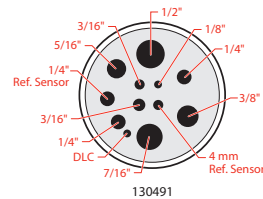

Custom Designed Inserts (Ø 63.5 mm; 160 mm length)

Inserts	Cat. No.
Single-Hole (SUT + DLC + Reference Holes)	130493
Multi-Hole (Max. 7 holes + DLC hole)	130494
Multi-Hole (Max 7 SUT holes)	130495

Custom inserts are supplied with a matching plug. Fill in insert scheme 105171 upon order.

Extended Inserts for Sanitary Sensors (Ø 63.5 mm; 173 mm length)

Inserts	Cat. No.
Undrilled Insert with Cable Groove for STS102 Cable for Sanitary Sensor Calibration	130263
Custom Insert with Cable Groove for STS102 Cable and Drilled Hole for Sanitary Sensor Calibration	130506
Adapter for ATC/RTCt-156 Sanitary Sensor Insert for Dry Calibration of Sanitary Sensors	130196
Undrilled Sanitary Sensor Insert RTCt-156	123824
Custom Insert RTCt-156 Sanitary Sensor Insert Drilled According to Customer Supplied Drawing	123868

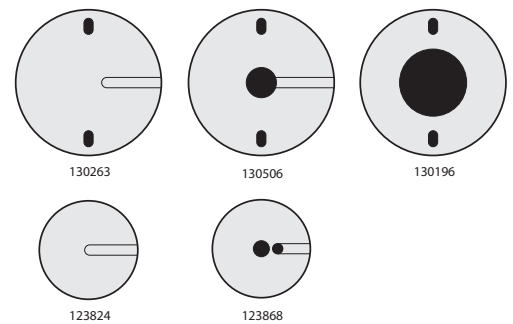

Options & Accessories

Standard Delivery

Models A, B, and C Include:

- RTcT dry-block calibrator (user specified)
- Mains power cable (user specified)
- Accredited certificate - temperature performance
- Wi-Fi Dongle
- Tool for insertion tubes
- JOFRACAL
- AMETRIM
- USB cable
- Set of rubber cones for insulation plugs
- Manual

Model B Instruments Also Include:

- Test cables (2 x red, 2 x black)
- Accredited certificate - input performance for reference sensor and DLC sensor
- Accredited certificate - input performance for sensor-under-test inputs

Model C Instruments Also Include:

- Accredited certificate - input performance for reference sensor and DLC sensor

Accessories

Wi-Fi Dongle (one included as standard)	130817
Support Rod Set for Sensors (2 grips, 2 fixtures)	127277
Extra fixture for sensor grip	125066
Extra sensor grip	125067
Thermocouple Male Plug – Type J – Black	120516
Thermocouple Male Plug – Type K – Yellow	120517
Thermocouple Male Plug – Type N – Orange	120514
Thermocouple Male Plug – Type T – Blue	120515
Thermocouple Male Plug – Type R / S – Green	120518
Thermocouple Male Plug – Type Cu-Cu – White	120519
Silicone Oil, Type 200/10cST, 0.75 L, RTcT-158/168	125033
Silicone Oil, Type 200/50cST, 0.75 L, RTcT-250	124885
Liquid Bath Kit, RTcT-168, L1, See page 14	130403
Liquid Bath Kit, RTcT-168, L2, See page 14	130508
Heat Conveyor for Liquid Kit, See page 9	130237
Adapter for RTcT-156 Sanitary Insert	130196
Carrying Case with Trolley	127782
Liquid Container with Lid, See page 12	130507

Functional Comparison



Model A
RTcT-A reference temperature calibrator.



Model B
RTcT-B reference temperature calibrator with input for reference sensor, DLC sensor, and sensors-under-test.



Model C
RTcT-C reference temperature calibrator with input for reference sensor and DLC sensor.



Models	Model A	Model B	Model C
Dual-zone heating/cooling block	■	■	■
MVI – Mains Variance Immunity (or similar)	■	■	■
Stability indicator	■	■	■
Automatic step function	■	■	■
USB communication	■	■	■
Display resolution 0.001°	■	■	■
Programmable max. temperature	■	■	■
External precision reference sensor input	■	■	■
External precision DLC reference sensor input	■	■	■
“SET” follows “TRUE”	■	■	■
Load compensation functionality	■	■	■
Input for RTD, TC, V, mA	■	■	■
4-20 mA transmitter input incl. 24 VDC supply	■	■	■
All inputs scalable to temperature	■	■	■
Automatic switch test (open, close, and hysteresis)	■	■	■
Download of calibration work orders from PC*	■	■	■
Upload of calibration results (as found & as left)	■	■	■

* Current accredited 17025 calibration certificates and specifications include axial 50 mm gradients as standard

Ordering Information

Base Model Number	
RTcT168	RTcT-168 series, -30 to 165°C (-22 to 329°F)
Model Version	
A	Basic model, without input
B	Full model, incl. DLC sensor input, Reference sensor input, Sensor-under-test input
C	Middle model, incl. DLC sensor input, Reference sensor input
Power Supply (US deliveries 60 Hz only)	
115	115 VAC
230	230 VAC
Mains Power Cable	
A	European, 230 V
B	USA/Canada, 115 V
C	UK, 240 V
D	South Africa, 220 V
E	Italy, 220 V
F	Australia, 240 V
G	Denmark, 230 V
H	Switzerland, 220 V
I	Israel, 230 V
Insert Type and Size	
NON	NON, No insert. The inserts must be ordered separately, see page 19
Dynamic Load Compensation (B and C models only— optional)	
DLC	DLC sensor
STS Reference Sensor (B and C models only— optional)	
R26	STS-102A-035 Ref. sensor. Dia. 4 mm. Length 35 mm (STS102A035EH) for RTcT-168
R24	STS-200 Ref. sensor. Dia. 4 mm. Length 201 mm (STS200A919EH) for RTcT-168
R25	STS-200 Ref. sensor. Dia. 1/4". Length 201 mm (STS200B919EH) for RTcT-168
Calibration Certificate	
H	Accredited Certificate — ISO17025
HL	Accredited Certificate — ISO17025 — In Liquid
EA	Full EURAMET Accredited Certificate — ISO17025
HS	System Calibration — Accredited Certificate — ISO17025 (B & C model only)
HSL	System Calibration — Accredited Certificate — ISO17025 (B&C model only) — In Liquid
HSQL	System Calibration — Accredited Certificate — ISO17025 (B&C model only) — In Container Liquid
EAS	System Calibration — Full EURAMET Accredited Certificate — ISO17025 (B & C model only)
EASD	System Calibration — Full EURAMET Accredited Certificate with DLC — ISO17025 (B & C model only)
Base Model Number	
CT ..	Solid Protective Carrying case with trolley
SR ..	Support rod set
TR ..	Solid Protective Carrying case with trolley & Support rod set

Sample Order Number

RTcT168B230ANONDLCR26EACT

JOFRA RTcT-168 B with 230VAC, EU power cord, no insert (to be ordered separately), DLC, 4 mm diameter STS-200 reference sensor, full EA temperature calibration certificate, and carrying case with trolley.

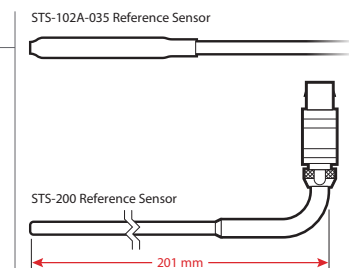

RTcT168 B 230 A NON DLC R26 EA CT

No part of this document may be reproduced or modified in any form or by any means, electronic or mechanical, without express written permission from JOFRA.
©2023 AMETEK Incorporated

