

RAYNGER[®] 3i[™] SERIES

OPERATOR'S MANUAL

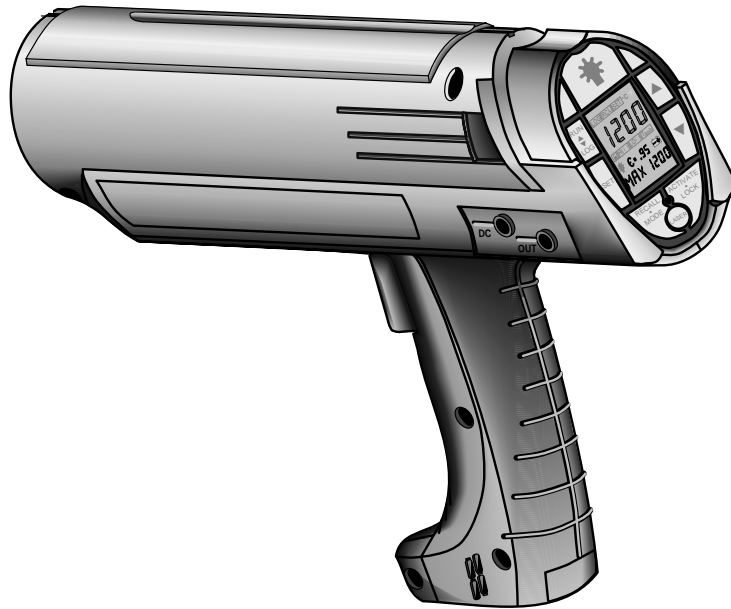

 **Raytek[®]**

Rev H
6/98
56700-1

WARRANTY

Raytek warrants each instrument it manufactures to be free from defects in material and workmanship under normal use and service for the period of one year from date of purchase. This warranty extends only to the original purchaser. This warranty shall not apply to fuses, batteries, or any product which has been subject to misuse, neglect, accident, or abnormal conditions of operation.

In the event of failure of a product covered by this warranty, Raytek will repair the instrument when it is returned to an authorized Service Facility within one year of the original purchase, provided the warrantor's examination discloses to its satisfaction that the product was defective. The warrantor may, at its option, replace the product in lieu of repair. With regard to any instrument returned within one year of the original purchase, said repairs or replacement will be made without charge. If the failure has been caused by misuse, neglect, accident, or abnormal conditions of operation, repairs will be billed at nominal cost. In such cases, an estimate will be submitted before work is started, if requested.

THE FOREGOING WARRANTY IS IN LIEU OF ALL OTHER WARRANTIES, EXPRESSED OR IMPLIED, INCLUDING BUT NOT LIMITED TO ANY IMPLIED WARRANTY OF MERCHANTABILITY, FITNESS, OR ADEQUACY FOR ANY PARTICULAR PURPOSE OR USE. RAYTEK SHALL NOT BE LIABLE FOR ANY SPECIAL, INCIDENTAL, OR CONSEQUENTIAL DAMAGES, WHETHER IN CONTRACT, TORT, OR OTHERWISE.

WORLDWIDE HEADQUARTERS

Raytek Corporation
1201 Shaffer Road, PO Box 1820
Santa Cruz, CA 95061-1820 USA

Portable Products Division

800 866 5478
Phone 408 458 1110
Fax 408 425 4561

WORLD WIDE WEB

www.raytek.com

Offices worldwide:

BRAZIL

Raytek do Brasil
Sorocaba, Brasil
Phone 55 152 276556

CHINA

Raytek China Company
Beijing, China
Phone 86 10 437 0284

JAPAN

Raytek Japan, Inc.
Tokyo, Japan
Phone 03 5976 1531

EUROPEAN HEADQUARTERS

Raytek GmbH
Arkonastrasse 45-49
D-13189 Berlin, Germany
Phone 49 30 478 0080
FAX 49 30 471 0251

MEXICO

Raytek de Mexico
Puebla, Mexico
Phone 52 22 30 4380

UNITED KINGDOM

Raytek UK
Milton Keynes, UK
Phone 44 1 908 630800

® Raytek and Raynger are registered trademarks and 3i is a trademark of Raytek Corporation

© 1997 Copyright Raytek Corporation

TABLE OF CONTENTS

<i>SECTION</i>	<i>PAGE</i>
1.0 INTRODUCTION.....	1-1
1.1 DESCRIPTION.....	1-1
1.2 INVENTORY.....	1-2
1.3 MODEL IDENTIFICATION.....	1-3
2.0 OPERATION.....	2-1
2.1 QUICK START.....	2-2
2.2 PRINCIPLES OF OPERATION.....	2-3
2.3 YOUR PORTABLE INFRARED THERMOMETER.....	2-4
2.4 OPERATION AND CONTROLS.....	2-6
2.4.1 Battery/AC Adaptor Installation.....	2-6
2.4.2 Control Panel and Display.....	2-7
2.4.3 Control System.....	2-10
2.4.3.1 Control Loops.....	2-10
2.4.3.2 General Information.....	2-11
2.4.4 RUN Loop—To Measure Temperature.....	2-12
2.4.5 LOG Loop—To Measure and Store Temperature.....	2-14
2.4.6 RECALL Loop—To Recall Measured Temperature.....	2-16
2.4.6.1 RECALL Values from RUN.....	2-16
2.4.6.2 RECALL Values from LOG.....	2-17
2.4.7 SETUP Loop—To Setup and Activate Alarms and Features.....	2-19
2.4.7.1 SETUP Values for RUN.....	2-19
2.4.7.2 SETUP Values for LOG.....	2-21
2.5 USING A TRIPOD.....	2-22
2.6 DATA OUTPUTS.....	2-23
2.6.1 Digital Output.....	2-24
2.6.1.1 Data Output—RUN Loop.....	2-24
2.6.1.2 Data Output—SET Loop.....	2-25
2.6.1.3 Data Output—LOG Run Loop.....	2-26
2.6.1.4 Data Output—LOG SETUP Loop.....	2-27
2.6.2 Analog Output.....	2-28
<i>SECTION</i>	<i>PAGE</i>

2.7	SIGHTING SYSTEMS.....	2-29
2.7.1	Single Laser Sighting	2-31
2.7.2	Dual Laser Sighting.....	2-31
2.7.3	Crossed Laser Sighting.....	2-32
2.7.4	Scope Sighting	2-32
3.0	SPECIFICATIONS	3-1
3.1	THERMAL	3-1
3.2	OPERATIONAL	3-2
3.3	ELECTRICAL	3-3
3.4	ENVIRONMENTAL.....	3-4
3.5	PHYSICAL	3-4
3.6	DEFAULT VALUES	3-5
3.7	REGULATORY	3-6
4.0	MAINTENANCE.....	4-1
4.1	BATTERY REPLACEMENT	4-1
4.2	CLEANING	4-1
4.2.1	Front Window Cleaning.....	4-1
4.2.2	Cleaning the Housing.....	4-2
4.3	LASER MAINTENANCE	4-2

SECTION	PAGE
----------------	-------------

APPENDIX A: OPTICAL	A-1
HOW TO READ THE OPTICAL CHARTS.....	A-1
OPTICAL CHARTS	A-2
APPENDIX B: OBJECT EMISSIVITY	B-1
HOW TO DETERMINE OBJECT EMISSIVITY	B-1
TYPICAL EMISSIVITY VALUES.....	B-2
APPENDIX C: TROUBLESHOOTING	C-1
APPENDIX D: OPTIONS AND ACCESSORIES	D-1
APPENDIX E: TRACEABILITY OF INSTRUMENT CALIBRATION	E-1
APPENDIX F: CE CONFORMITY FOR THE EUROPEAN COMMUNITY	F-1

GLOSSARY OF TERMS

INDEX

1.0 INTRODUCTION

1.1 DESCRIPTION

The Raynger® 3i™ series of instruments are portable infrared temperature measurement devices. Each model is rugged and easy to use for making fast, noncontact, non-destructive temperature measurements. They can measure operating temperatures of mechanical, electrical, or production equipment without removing the equipment from service. They can also measure product temperatures during manufacturing or storage without contaminating or marring the product. Table 1-1 lists the standard Raynger 3i models.

Table 1-1: Raynger 3i Models

MODEL	TEMPERATURE RANGE	OPTICAL RESOLUTION	SPECTRAL RANGE	SIGHTING
LTDL2 & LTDL3	-30 to 1200°C (-20 to 2200°F)	75:1	8-14 μ	dual laser
LTSC	-30 to 1200°C (-20 to 2200°F)	75:1	8-14 μ	scope
LTCL2 & LTCL3	-30 to 1200°C (-20 to 2200°F)	75:1	8-14 μ	crossed laser
LRSC	-30 to 1200°C (-20 to 2200°F)	120:1	8-14 μ	scope
LRSC2	-30 to 1200°C (-20 to 2200°F)	105:1	8-14 μ	single laser with scope
LRL2 & LRL3	-30 to 1200°C (-20 to 2200°F)	120:1	8-14 μ	single laser
P7DL2 & P7DL3	10 to 800°C (50 to 1450°F)	25:1	7.9 μ	dual laser
G5SC	150 to 1800°C (300 to 3275°F)	50:1	5.0 μ	scope
1MSC	600 to 3000°C (1100 to 5400°F)	180:1	1.0 μ	scope
1ML2 & 1ML3	600 to 3000°C (1100 to 5400°F)	180:1	1.0 μ	single laser
2MSC	200 to 1800°C (400 to 3275°F)	90:1	1.6 μ	scope
2ML2 & 2ML3	200 to 1800°C (400 to 3275°F)	90:1	1.6 μ	single laser

Each model is molded from rugged, high-strength, solvent resistant plastic and is actuated by a two-stage trigger (second stage is used for data logging only). Each model has the following:

- High quality optical system
- Infrared detector
- Circuit board assembly with microprocessor
- LCD display with backlighting feature
- Touch-sensitive membrane switches for changing loops and modes
- Battery compartment for four AA batteries
- Power input jack for AC adaptor
- Signal output jack (analog 1mV per degree/digital RS232)
- A rugged, padded pouch for easy carrying

There are four types of laser sighting models:

- Single laser—shows the center of the measurement area.
- Dual laser—shows the spot diameter of the measurement area.
- Crossed laser—the point where the two laser beams cross is the location of the minimum diameter measurement spot.
- Single laser with scope

1.2 INVENTORY

Your Raynger 3i package contains the following:

- Raynger 3i
- Carrying Case
- Operator's Manual
- Four (4) AA batteries
- Warranty card

1.3 MODEL IDENTIFICATION

Refer to Table 1-1 for a list of standard models along with their temperature ranges, optical resolutions, spectral ranges, and sighting systems.

You can determine the exact model number of your unit by looking at the manufacturing label on the underside of the unit. On the label is an area for model designation. The model type is printed in the following format:

XXXYYYZZZZZ

where **XXX** is an abbreviation of the company name, **YYY** is the product (or abbreviation of the product name), and **ZZZZZ** is the model type. (Model type may be four or five characters long. Refer to Table 1-1 to compare the label to model type.)

2.0 OPERATION

This portion of the manual contains the following sections:

- **Quick Start**—To use your unit right away, follow the brief instructions on basic operating procedures in this section.
- **Principles of Operation**—A short introduction to infrared thermometry.
- **Your Portable Infrared Thermometer**—Describes and illustrates the thermometer's control panel, display, and features.
- **How to Operate**—A detailed user guide that describes each of the operating modes. It includes descriptions of the RUN, RECALL, SETUP, and Data Logger loops.
- **Data Outputs**—How to use the analog and digital (RS232) outputs to connect the thermometer to a printer, chart recorder, or computer.

WARNING—LASER SAFETY

Models with laser sighting produce visible laser radiation that may be harmful to the human eye. Be aware of the following:

- **Avoid direct exposure of human eyes to laser light. Eye damage can result.**
 - **Use extreme caution when operating.**
 - **Never point the unit at another person.**
 - **Keep out of the reach of children.**
 - **Refer to the FDA laser label on the unit for specific information.**
-

IMPORTANT

1. **If the unit is exposed to significant changes in ambient temperature (hot to cold or cold to hot), allow 45 minutes for temperature stabilization before taking measurements.**
 2. **Do not operate the unit near large electrical or magnetic fields such as arc welders and induction heaters. These fields can cause measurement errors.**
 3. **For the short wavelength units (e.g., 2 μm and below)—Avoid taking temperature measurements in bright sunlight. High levels of ambient light may produce apparently valid high-temperature readings when no target is in the thermometer's field-of-view.**
-

2.1 QUICK START

To use your portable infrared thermometer right away, complete the following steps:

Note: For complete definitions of your portable thermometer's modes and functions, and for a full explanation on its operation, refer to Sections 2.3 and 2.4.

1. Point the instrument at the object you want to measure (perpendicular to the object) and pull the trigger. The current temperature (in °C or °F), the emissivity value, and the maximum measured temperature will be displayed (similar to Figure 2-1).
2. Change the emissivity value to correspond to the material you are measuring by pressing the ▲ and ▼ buttons. (For example, if you are measuring wrought iron with an 8-14 micron instrument, set emissivity to 0.90. If you are measuring asphalt, leave the emissivity at the default setting of 0.95. For other materials and for instruments with other spectral ranges, refer to the emissivity charts in Appendix B.)

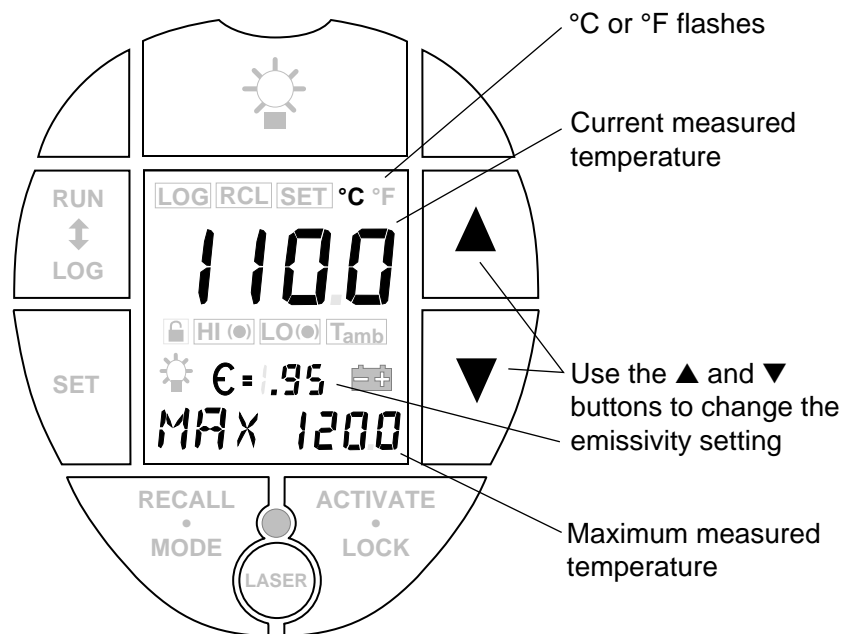

Figure 2-1: Quick Start Display

2.2 PRINCIPLES OF OPERATION

An infrared thermometer and the human eye are very similar. An infrared thermometer has a lens that focuses infrared radiation from an object onto a detector. The eye focuses light onto the retina. The detector is stimulated by the incoming infrared energy and produces a signal that is transmitted to the circuitry. The retina is stimulated by incoming light and sends a signal to the brain. The circuitry processes this signal and computes the temperature of the object.

The intensity of an object's emitted infrared energy increases or decreases in proportion to its temperature. The higher the temperature of the target, the greater the intensity of infrared radiation.

To calibrate a noncontact temperature measurement instrument, the manufacturer uses a blackbody. A blackbody is a perfect emitter because it absorbs and emits all radiant energy but reflects or transmits none. The emissivity value of a blackbody is 1.00. Figure 2-2 shows the radiant emittance values of a blackbody at various temperatures and wavelengths.

Most objects have emissivities that are less than 1.00 but are reasonably uniform at all wavelengths of the infrared spectrum. These are called graybodies. The non-ideal (less than 1.00) emissivity values of different materials can be compensated for, by the emissivity controls, so that accurate temperature readings can be obtained. Emissivity values for many common materials (both metals and non-metals) are listed in Appendix B.

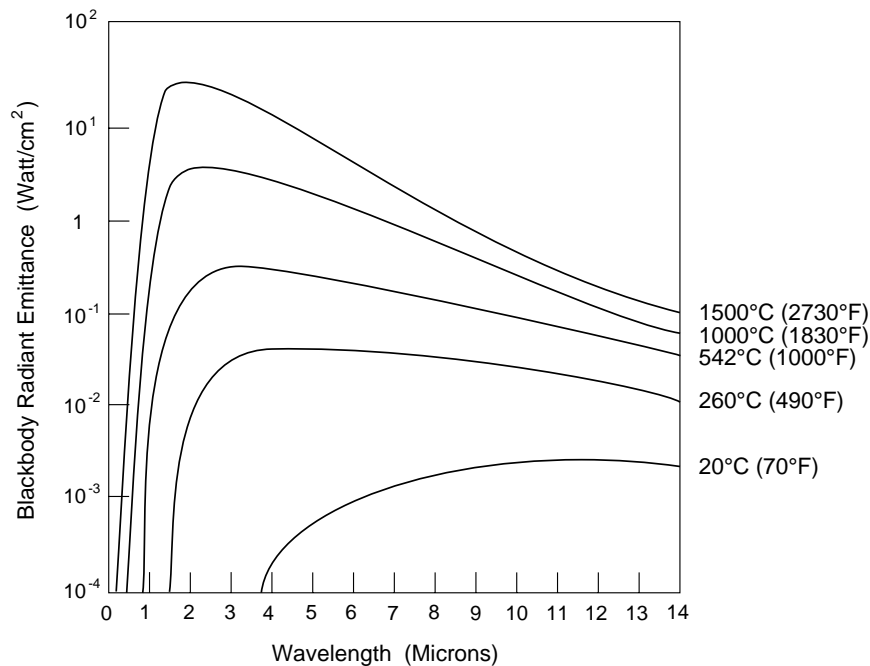

Figure 2-2: Blackbody Radiation Curves

2.3 YOUR PORTABLE INFRARED THERMOMETER

Portable infrared thermometers measure surface temperatures without touching the surface. They collect the infrared energy radiated by a target and compute its surface temperature. They also compute the running average, maximum, minimum, and differential temperatures and present them on a digital display in either degrees Celsius or Fahrenheit. A digital/analog output allows data recording, instrumentation or process control, and/or remote display of temperature and emissivity. The instrument is battery powered or can be powered by an optional AC adaptor.

Internal memory circuits store temperature data for later recall, and a datalogging feature allows you to store up to 100 temperature, emissivity, and alarm readings (valuable for comparative analysis).

Figure 2-3 shows the features of the portable infrared thermometer.

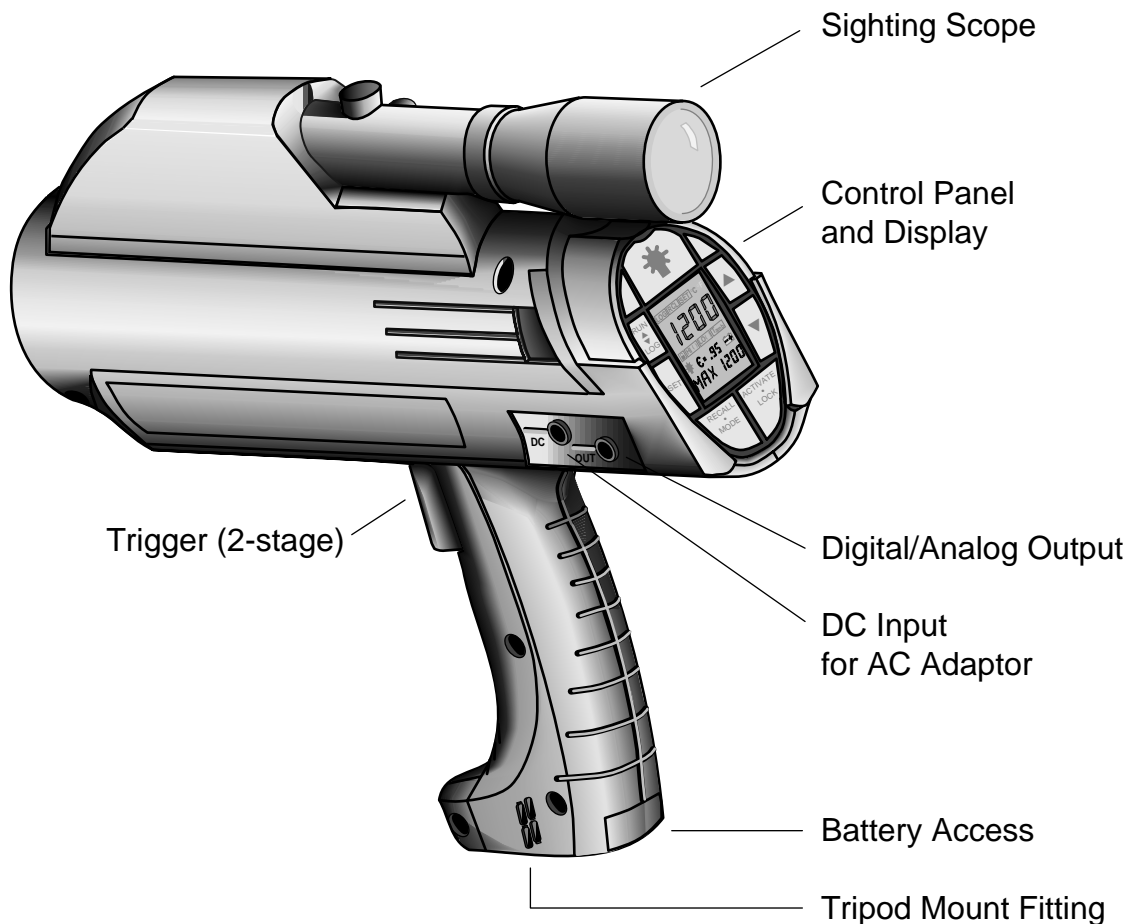

Figure 2-3: Features

Your portable thermometer has the following:

- **Trigger**—Two-stage trigger. The first stage activates the unit to take temperature readings. The second stage is functional only in the datalog mode. To store a temperature reading, pull the trigger all the way in until you hear the tone (the tone signals that the reading has been stored). When you release the trigger, the unit goes to sleep.
- **Control Panel and Display**—All controls (except the trigger) are located on the control panel. The display shows temperature and setup values, mode and loop status, and operating information.
- **Sighting System**—Laser or scope sighting is provided with each model.

Note: Read the laser warning label before operating the laser.

- **Analog Output**—Connects the instrument to analog recording/printing devices such as chart recorders and printers.
- **Digital Output**—An RS232 interface to connect the instrument to a computer or directly to a printer's RS232 port.
- **DC In**—AC adaptor connection.

2.4 OPERATION AND CONTROLS

This section instructs you in the operation of the instrument. It describes battery and/or AC adaptor installation and the controls and functions of the different control loops and operating modes.

2.4.1 Battery/AC Adaptor Installation

The instrument may be powered by batteries or an AC adaptor. Battery power is supplied by 4 "AA" batteries. The batteries are located in the base of the handle. AC power is supplied by an optional AC power adaptor (DIN VDE 0551 approved). NiCad batteries can also be used, but battery life will be substantially reduced. Figure 2-3 shows the location of the battery compartment, battery orientation, and the location of the AC adaptor power connection.

Table 2-1 shows approximate battery life (for alkaline batteries) for various operating conditions.

Table 2-1: Battery Life (Alkaline)

CONDITION	HOURS OF CONTINUOUS USE
Laser OFF Backlight OFF	25
Laser ON Backlight OFF	12.5
Laser OFF Backlight ON	12.5
Laser ON Backlight ON	10
"Sleep" mode (trigger off)	1 year

Notes: Battery types and brands vary in length of usable life. The values in Table 2-1 are approximate for new alkaline batteries. The instrument will continue to read accurately up to 4 hours after the low battery icon displays if the laser and backlight are off.

Remove the batteries if the unit is not used for long periods of time.

220 VAC adaptors must have DIN VDE 0551 approval to be used with IEC Class 2 laser units.

2.4.2 Control Panel and Display

Figure 2-4 shows the display and controls. Descriptions of these, in alphabetical order, follow the illustration.

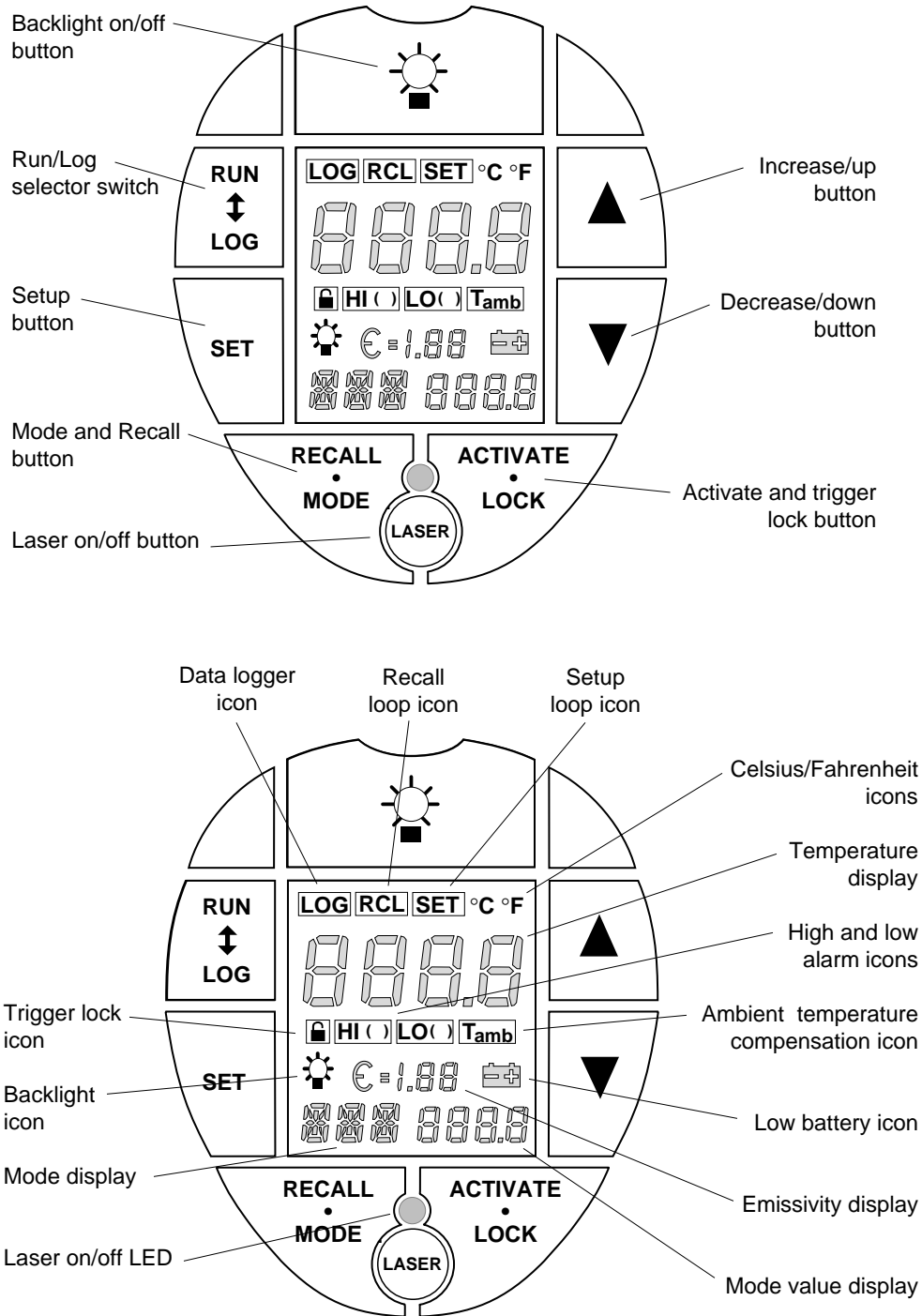

Figure 2-4: The Control Panel and Display

Activate button—Press the activate button to activate HAL, LAL, or TAM, or to toggle between DIG/ANA, or °C/°F, in the SET loop.

Backlight button and icon—The display has a backlight for working in low lighting conditions. Press the backlight button to activate or deactivate the backlight. The backlight icon is activated when the backlight is on. To save battery power, use the backlight only when necessary. Note that if the battery voltage falls below 4.0 V, the backlight will automatically turn off.

Low battery icon—The instrument is powered by four “AA” batteries. When the battery voltage falls below 4.6 V, the low battery icon is activated.

Note: Turning off the backlight and laser will extend the battery life (refer to Table 2-1 for battery life under various conditions).

Celsius/Fahrenheit icons—The °C and °F icons indicate which temperature scale has been selected.

LOG button and icon—Press the LOG/RUN button while you have the trigger pulled to toggle between the LOG and RUN loops. The LOG icon is activated when the instrument is in the LOG loop.

Emissivity display—The emissivity display shows the emissivity value selected in either the RUN, RECALL, or LOG loops.

▲ and ▼ buttons—▲ increases and ▼ decreases the emissivity settings, DOI rate, HAL or LAL set-points, TAM, or the LOG location number.

High and Low alarm icons—These are activated when the corresponding alarms are activated. The HAL icon flashes and the buzzer sounds when measured temperature is greater than or equal to HAL and HAL is active. The LAL icon flashes and the buzzer sounds when the measured temperature is less than or equal to LAL and LAL is active. Note that when a high or low alarm condition is met and the unit is sending out RS232 data while in the Digital Output mode, the buzzer will make two tones: a normal tone followed by a higher pitched tone.

Laser on/off button and LED—Press the laser button to activate or deactivate the laser (RUN and LOG loops only). The laser LED is activated when the laser is activated. (Not applicable for the scope sighting model.) Note that if the battery voltage falls below 4.3 V, the laser will automatically turn off. Also, if the unit is in the LOCK mode, the laser will go off when the trigger is released.

Temperature display—Shows the current temperature (while the trigger is pulled) or the last temperature measured (when the RECALL button is pressed).

Mode button—Press the mode button to change modes in any of the four loops.

Mode display and Mode value display—The Mode display shows the current mode selected. The mode value display shows the temperature, set-point, or LOG location value for the mode selected.

Recall button and icon—Press the RCL button to activate the RECALL loop. The RECALL loop may be used to recall values from either the RUN or LOG loops. The RCL icon is activated when the instrument is in the RECALL loop.

RUN button—Press the RUN/LOG button, when the trigger is pulled, to toggle between the RUN and LOG loops.

Setup button and icon—Press the SET button to activate the SETUP loop. The SETUP loop may be used to set values in either the RUN or LOG loops. The SET icon is activated when the instrument is in the SET loop.

T_{amb} icon—This is activated when the ambient temperature compensation function is activated. This feature only affects readings in the RUN loop; readings in the LOG loop are not affected.

Trigger lock icon—The small padlock is the trigger lock icon and is activated when LOCK is pressed while the trigger is pulled. To unlock the trigger, simply press the LOCK button again.

2.4.3 Control System

The control system consists of four loops: SET, RUN, RECALL and LOG. The instrument may be cycled to any of the four loops by using the trigger or control panel buttons, as shown below.

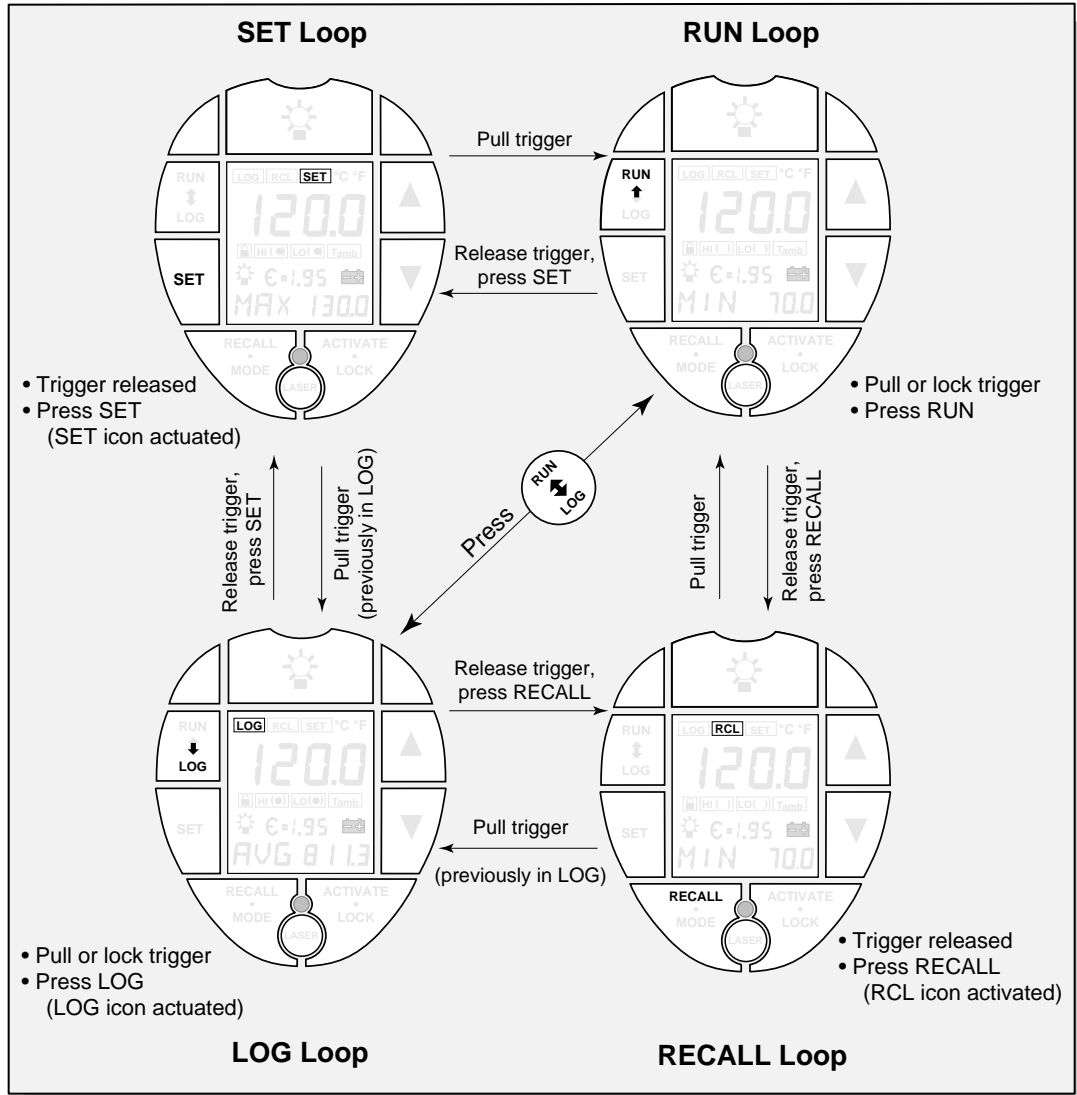

Figure 2-5: Control Loops

2.4.3.1 Control Loops

Each control loop has several modes, which are described in the following sections.

2.4.3.2 General Information

Before you begin using your portable instrument, you should be aware of the following general operating rules:

- The instrument goes to “sleep” (low power consumption, no display, no laser, no backlight) after different times for each loop, as follows:
 - SET Loop (after last button use): 10 seconds
 - RUN Loop (after releasing the trigger): immediately
 - RECALL Loop (after last button use): 10 seconds
 - LOG Loop (after releasing trigger): immediately
- The backlight can be turned on or off in any mode.
- The laser can be used only in the RUN and LOG loops.
- The trigger has two stages. The first stage is for measuring temperature. The second stage, when the trigger is pulled all the way in, is for storing temperature values in the LOG loop.
- The °C or °F icon flashes when the instrument is measuring temperature in the RUN or LOG loops. It does not flash when values are recalled.
- You can lock the trigger in the RUN loop and the LOG loop.
- You must release the trigger to go into the SET or RECALL loops.
- When you simultaneously press the MODE and ACTIVATE buttons while in the RUN loop, the instrument is reset to the RUN loop factory default settings (stored data is unaffected). In the LOG loop, pressing the MODE and ACTIVATE buttons not only resets the instrument to its LOG loop factory default settings, but also clears all previously stored data. In both cases, the instrument will “beep” after reinstalling the default settings. Section 3.6 lists default setting for each model as well as non-model-specific default settings and range values.

IMPORTANT

For the short wavelength units (e.g., 2 μm and below)-Avoid taking temperature measurements in bright sunlight. High levels of ambient light may produce apparently valid high-temperature readings when no target is in the thermometer’s field-of-view.

2.4.4 RUN Loop-To Measure Temperature

The RUN loop is for taking temperature measurements. Figure 2-6 illustrates the RUN loop.

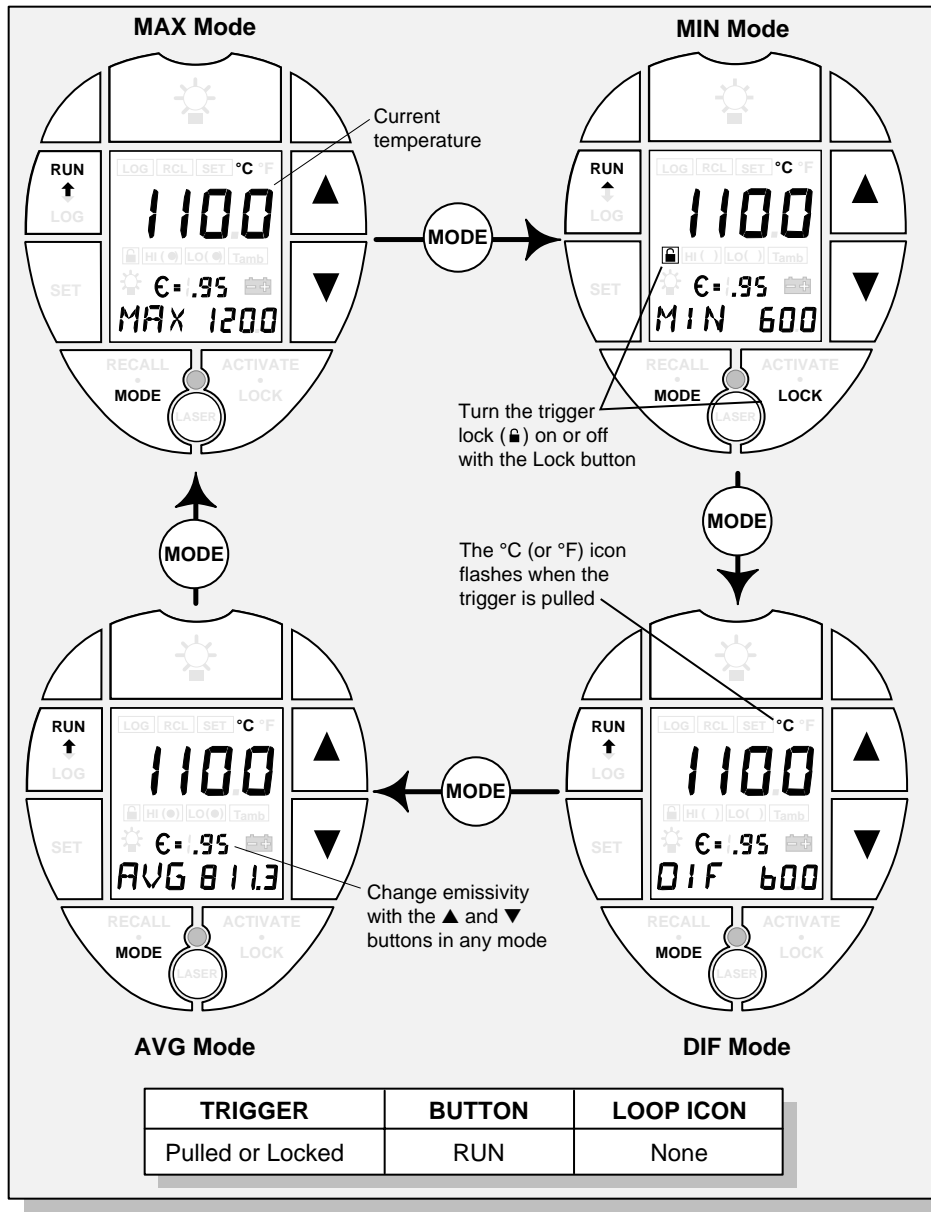

Figure 2-6: RUN Loop

To take a measurement, do the following:

1. Point the instrument at the target.
2. Pull the trigger (press the RUN/LOG button, if necessary, so that the LOG icon is not activated).

3. Press the laser button to activate the laser (if equipped with laser sighting).
4. Carefully aim using the laser or scope.

Note: The laser or scope indicate the target (see Sections 2.7.1 through 2.7.4). Make sure the spot you are measuring fills the target.

5. Read the temperature from the display.

RUN contains 4 modes: MAX, MIN, DIF, and AVG (as shown in Figure 2-7). In RUN, the current temperature and emissivity setting along with either the MAX, MIN, DIF, or AVG temperature can be displayed. Note that AVG is a weighted average of all readings taken since the trigger was pulled. The unit uses the following formula to calculate the running average (while the trigger is pulled):

$$\frac{R_1 + R_2 + R_3 + \dots R_n}{n} = \text{AVG}$$

where R = a reading and n = the total number of readings.

- Press the MODE button to change modes.
- Press the ▲ or ▼ buttons to change emissivity.
- Press the backlight button if a brighter display is necessary.

Note: When you simultaneously press the MODE and ACTIVATE buttons while in the RUN loop, the instrument is reset to its RUN loop factory default settings (stored data is unaffected). The instrument will “beep” after reinstalling the default settings. Section 3.6 lists default setting for each model as well as non-model-specific default settings and range values.

2.4.5 LOG Loop-To Measure and Store Temperature

The LOG loop is for making temperature measurements and storing them in the data logger locations. Figure 2-7 illustrates the LOG loop.

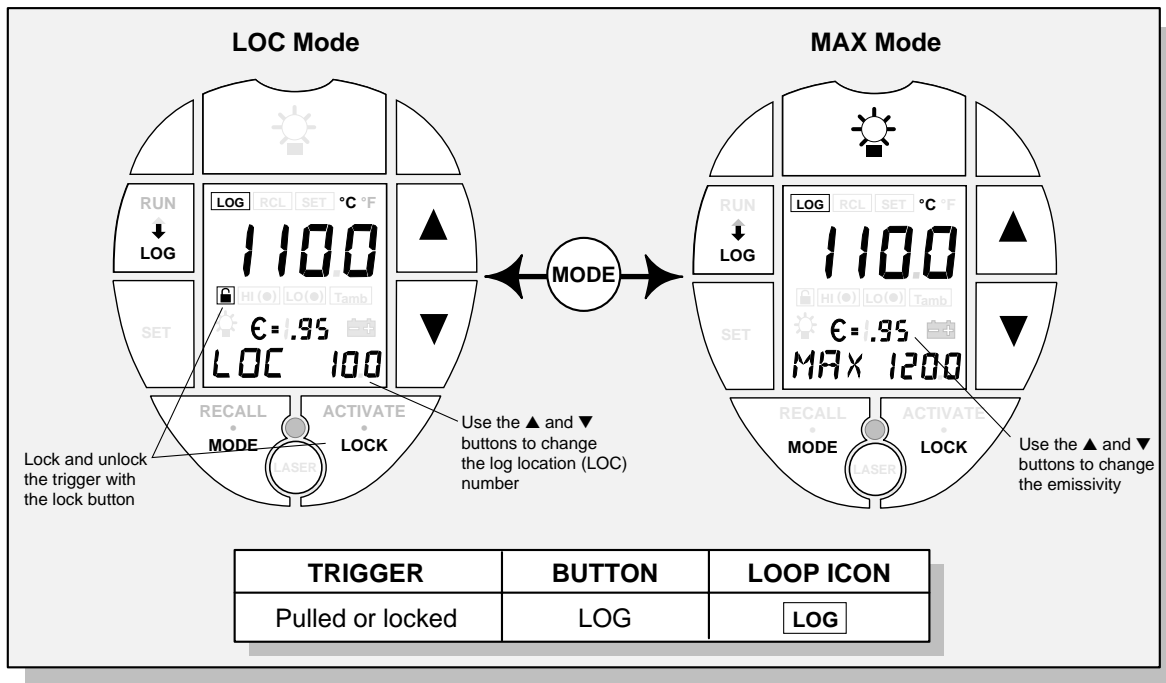

Figure 2-7: LOG Loop

To use the modes and functions of the LOG loop, do the following:

1. Point the instrument at the target.
2. Pull the trigger and press the RUN/LOG button, if necessary, so that the LOG icon is activated.
3. Press the ▲ or ▼ buttons to select the LOG location number where you want to store the measurement. To change the emissivity setting for that location, press the MODE button and use the ▲ or ▼ buttons .
4. Press the laser button to activate the laser (if equipped with laser sighting).
5. Carefully aim using the laser or scope.
6. Read the temperature from the display.

7. Pull the trigger further until you hear the “beep” indicating that the measurement has been stored. Both the current and MAX temperatures are stored in memory.

Notes: The instrument has a 2-stage trigger. The first stage is activated by pulling the trigger a small amount. The second stage (operational in LOG only) is activated when the trigger is pulled all the way.

To protect the data from being accidentally overwritten (trigger accidently pulled), press the RUN/LOG button to exit the LOG loop (the LOG icon is off).

8. Release the trigger.

LOG contains two modes: LOC (location) and MAX (as shown in Figure 2-7). In LOG, the current temperature and emissivity setting along with either the location number or MAX temperature can be displayed. Note the following:

- Press the MODE button to change between LOC and MAX modes.
- Press the ▲ or ▼ buttons to change the location number or the emissivity setting.
- Press the backlight button if a brighter display is needed.

Notes: If you change the emissivity after storing data, both the target temperature and MAX temperature will reset to zero. The instrument will “beep” to indicate this.

IMPORTANT

When you simultaneously press the MODE and ACTIVATE buttons while in the LOG loop, all previously stored data is cleared. The instrument also resets to its LOG loop factory default settings. The instrument will “beep” after reinstalling the default settings. Section 3.6 lists default setting for each model as well as non-model-specific default settings and range values.

2.4.6 RECALL Loop-To Recall Measured Temperatures

The RECALL loop is for recalling values from either the RUN or LOG loops.

2.4.6.1 RECALL Values from RUN

Figure 2-8 illustrates RECALL for RUN values.

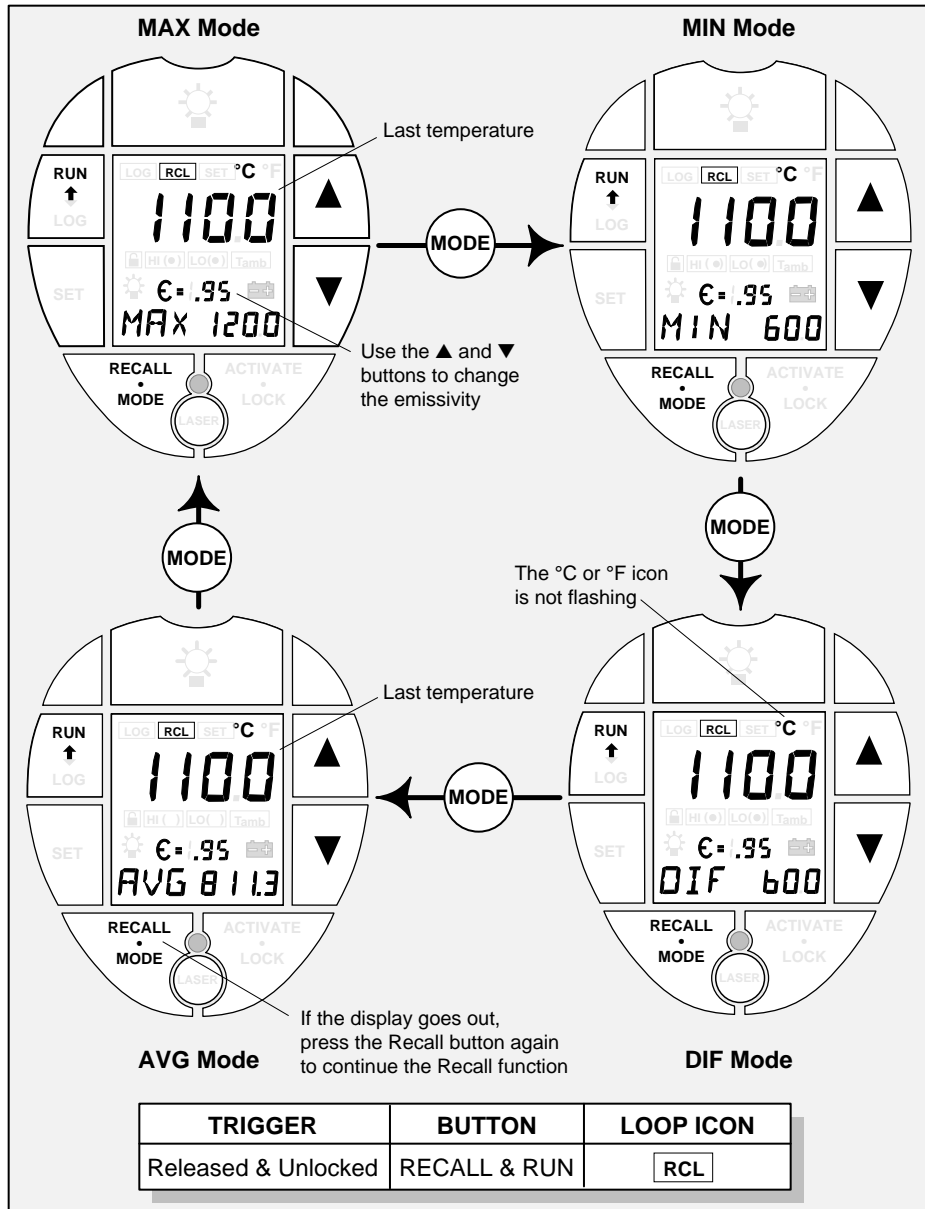

Figure 2-8: RECALL Loop-Recalling RUN Values

To recall values from the RUN loop, do the following:

1. Release or unlock the trigger, if necessary.
2. Press the RECALL button. The RCL icon will be activated.
3. Press the RUN/LOG button, if necessary, so that the LOG icon is not activated.
4. Read the recalled temperature from the display.

RECALL contains four modes: MAX, MIN, DIF, and AVG (as shown in Figure 2-8). In RECALL, the last temperature and emissivity setting along with either the MAX, MIN, DIF, or AVG temperature can be displayed. Note the following:

- Press the MODE button to change modes.
- Press the ▲ or ▼ button to change emissivity. (This shows the effect that a different setting would have. Note that if the target's temperature is known, you can determine its emissivity by this method. MAX, MIN, DIF, or AVG are not updated.)
- Press the backlight button if a brighter display is needed.

2.4.6.2 RECALL Values from LOG

Figure 2-9 illustrates RECALL for LOG values.

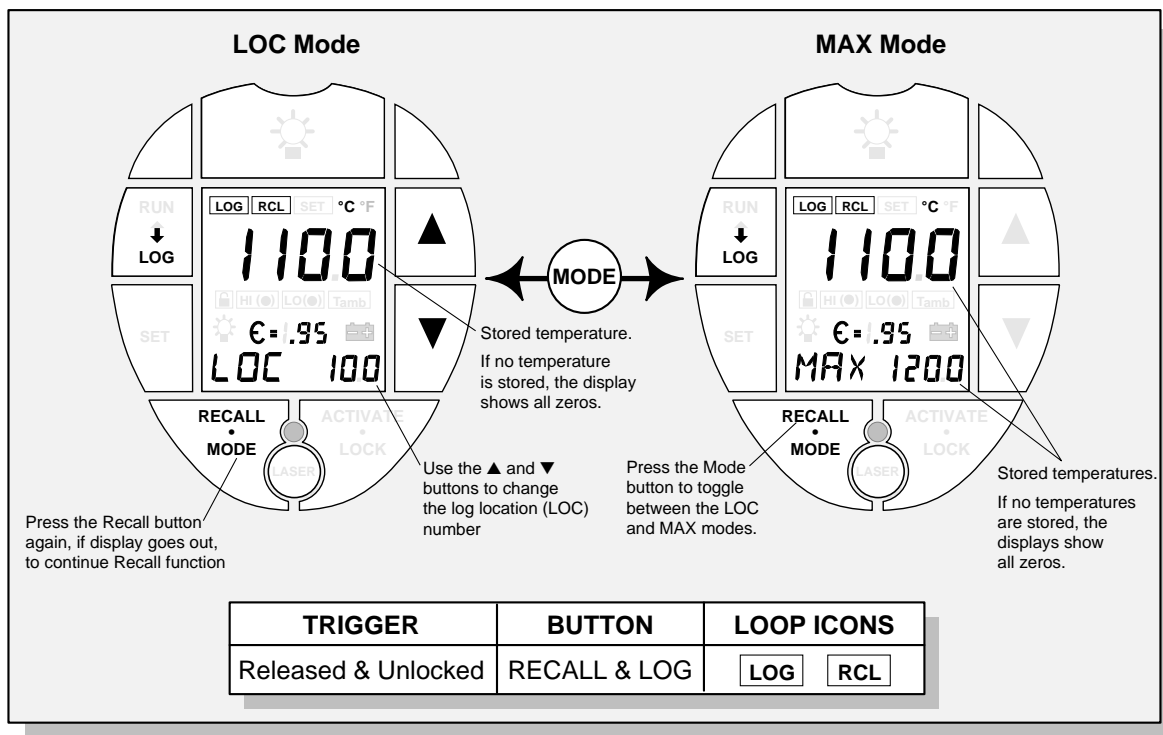

Figure 2-9: RECALL Loop–Recalling LOG Values

To recall values from the LOG loop, do the following:

1. Release or unlock the trigger, if necessary.
2. Press the RECALL button. The RCL icon will be activated.
3. Press the RUN/LOG button, if necessary, so that the LOG icon is activated.
4. Read the recalled temperature from the display.
5. Press the ▲ or ▼ buttons (LOC mode) to recall values from other LOG locations.

RECALL contains two modes: LOC (location) and MAX (as shown in Figure 2-9). In RECALL, the stored temperature and emissivity setting along with either the location number or MAX temperature can be displayed for each of the 100 LOG locations.

2.4.7 SETUP Loop-To Setup and Activate Alarms and Features

The SETUP loop is for setting up and activating alarms and features in either the RUN or LOG loops.

2.4.7.1 SETUP Values for RUN

Figure 2-10 illustrates SETUP for the RUN loop.

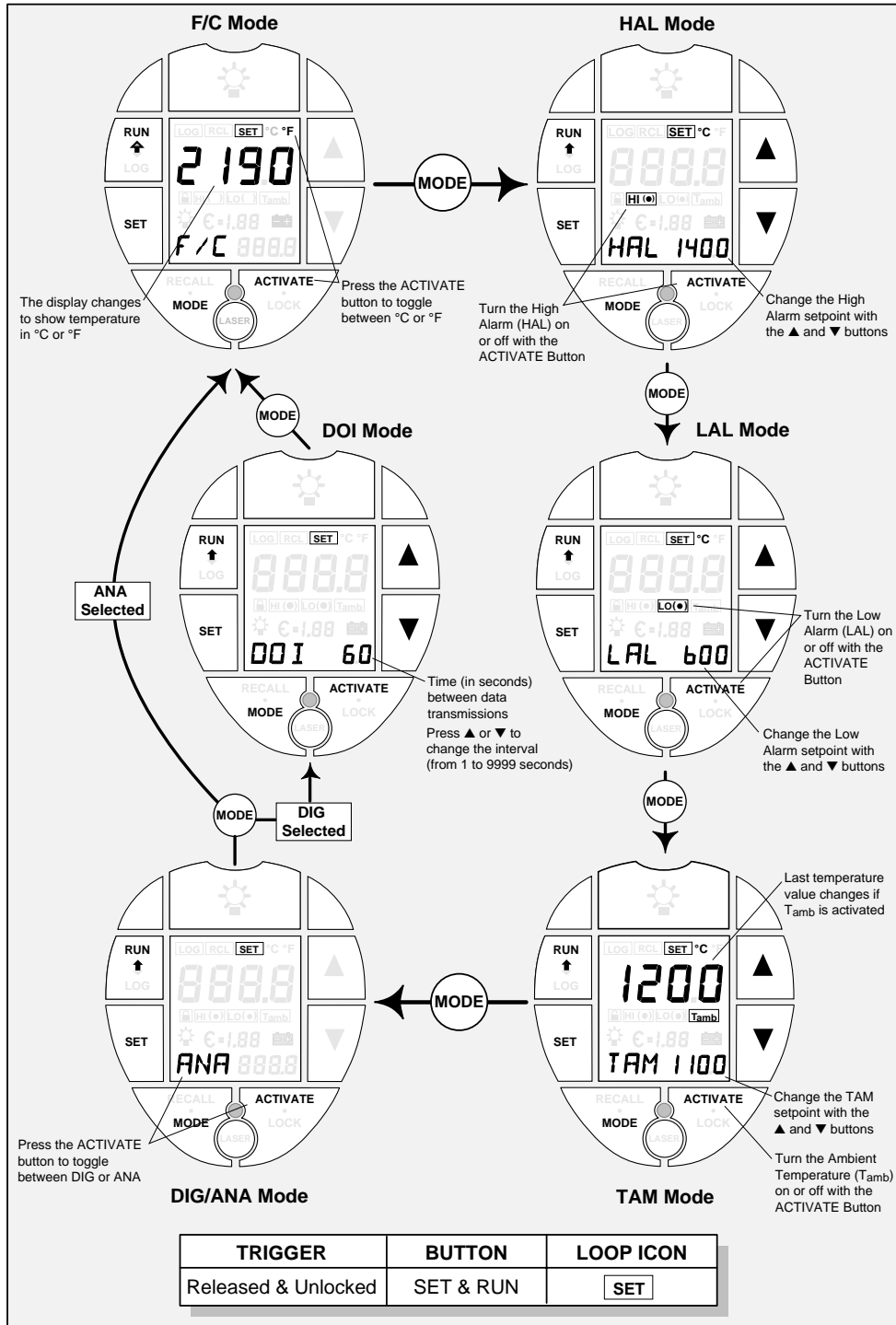

Figure 2-10: SETUP Loop–RUN Values

To setup values for the RUN modes and functions, do the following:

1. Release or unlock the trigger, if necessary.
2. Press the SET button. The SET icon will be activated.
3. Press the RUN/LOG button, if necessary, so that the LOG icon is not activated.
4. Press ACTIVATE to toggle between °C or °F for the display and data output.
5. Press the MODE button to switch between HAL, LAL, TAM, and DOI. Press the ▲ or ▼ buttons to change the HAL, LAL, TAM, and DOI settings.
6. Press ACTIVATE to activate the HAL, LAL, or TAM.
7. Press ACTIVATE to toggle between DIG (digital) or ANA (analog) outputs.
8. Press the ▲ or ▼ buttons to set DOI (Digital Output Interval) if DIG was selected.

SET contains six modes: °C/°F, HAL, LAL, TAM, DIG/ANA, and DOI (as shown in Figure 2-10). In SET, the temperature scale can be set for °C or °F, the HAL, LAL, and TAM setpoints can be displayed and set, the digital (DIG) or analog (ANA) output can be selected, and the Digital Output Interval (DOI) can be set. Note the following:

- Press the MODE button to change modes.
- Press the backlight button if a brighter display is needed.

Notes on setting T_{amb} (Ambient temperature compensation)—The T_{amb} icon is activated when the ambient temperature compensation function is active. Targets that have low emissivities will reflect energy from nearby objects. This additional reflected energy is added to the target's own emitted energy and may result in inaccurate readings. In some situations objects near the target (machines, furnaces, or other heat sources) have a temperature much higher than that of the target. In these situations it is necessary to compensate for the reflected energy from those objects. Note that the T_{amb} feature is disabled if the emissivity is set to 1.00.

To set or change the ambient temperature compensation, complete the following:

1. Go to the RUN loop (pull trigger, press RUN/LOG button, if necessary).
2. Set the emissivity value to 1.0.
3. Press the MODE button until the mode function indicator displays AVG (average temperature).
4. Pull the trigger and scan across objects and surfaces that face the target. Read the average temperature value in the MODE value display. This is the value to be entered as the reflected ambient temperature in Step 7 below. Release the trigger.
5. Press the SET button (do not pull the trigger) to enter the Setup mode
6. Press the MODE button until TAM shows in the mode function indicator.

7. Set the TAM value by pressing the ▲ and ▼ buttons.
8. Press the ACTIVATE button to turn on the ambient temperature compensation function. The Tamb icon will be displayed indicating that it is active. (Pressing ACTIVATE again turns off the function.)
9. Pull trigger and reset the emissivity to the proper value for the target. You can now take the target's temperature using normal procedures. The current temperature and all computed values, as well as the analog and digital outputs, will now be based on the compensated measurement.

Note: TAM only affects readings in the RUN loop; LOG loop readings are not affected.

2.4.7.2 SETUP Values for LOG

Figure 2-11 illustrates SETUP for the LOG loop.

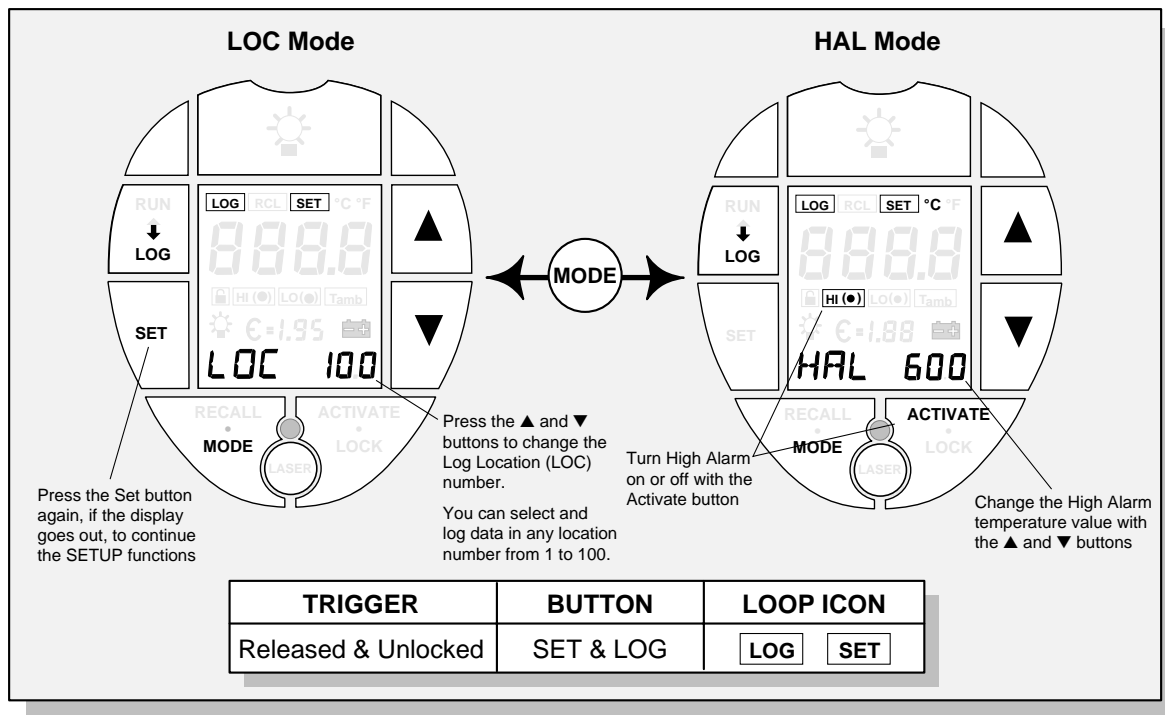

Figure 2-11: SETUP Loop-LOG Values

To setup values for the LOG modes and functions, do the following:

1. Release or unlock the trigger, if necessary.
2. Press the SET button. The SET icon will be activated.
3. Press the RUN/LOG button, if necessary, so that the LOG icon is activated.
4. Press the ▲ or ▼ buttons to select the LOG location number (LOC mode).

5. Press the MODE button.
6. Press the ▲ or ▼ buttons to change the HAL setting (HAL mode).
7. Press ACTIVATE to activate the HAL setting for the selected location.

SET contains two modes: LOC and HAL (as shown in Figure 2-11). In SET, the LOG location can be selected and the high alarm value (HAL) can be set for each location (independent of the setting for the RUN loop). Note the following:

- Press the MODE button to change modes.
- Press the backlight button if a brighter display is needed.

2.5 USING A TRIPOD

The instrument is equipped with a standard camera-type tripod mount fitting at the base of the handle. You can set it up for continuous use by mounting it on a sturdy tripod. This allows the instrument to be connected to a digital or analog recording or controlling device (computer, printer, chart recorder, line or temperature controller) to monitor temperatures over long periods of time.

Mounting the instrument is easy. Just attach it to the tripod by screwing the tripod's mounting screw into the fitting at the bottom of the handle.

You can also connect a digital or analog recording or controlling device to the digital/analog connector (labeled OUT) on the side of the instrument. For continuous monitoring, pull the trigger and press the LOCK button.

Note that battery life is shortened by continuous use. If you plan to monitor temperatures over long intervals, you should connect an AC adaptor to the DC IN connector.

2.6 DATA OUTPUTS

Data outputs from the instrument provide a direct interface to chart recorders, printers, and computers. All models are equipped with an output jack capable of providing analog and digital signals, which are user selectable in the SET loop. The format of these signals are as follows:

- Digital: RS-232
 - Format: ASCII data
 - Baud Rate: 9600
 - Data Format: 8 bits, 1 stop bit, no parity
- Analog: 1 mV/° (°C or °F) for all models except the 1M
1 mV/°C or 0.5 mV/°F for the 1M

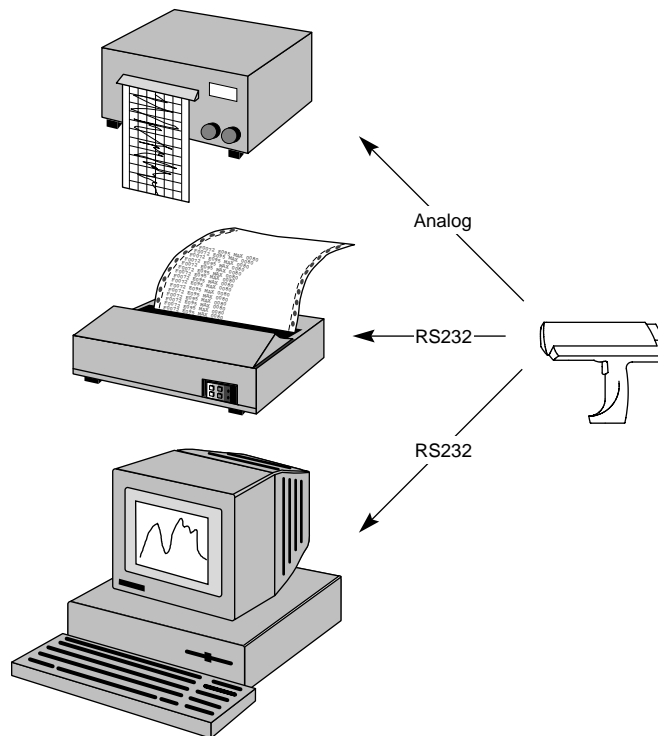

Figure 2-12: Data Outputs

2.6.1 Digital Output

The following sections describe the digital data outputs for each mode.

2.6.1.1 Data Output-RUN Loop

In the RUN loop, the temperature scale, current temperature, emissivity, mode temperature (MAX, MIN, DIF, or AVG), HAL or LAL, a carriage return, and a line feed are sent out at intervals determined by the DOI (set in the SET loop) when the trigger is pulled. HAL or LAL is sent out if the temperature is above HAL or below LAL (when they are activated). Three blank spaces replace HAL or LAL if they do not meet this condition. There are 5 characters for the mode temperature. The fifth character is always a space for MAX, MIN, or DIF. For AVG, the fifth character is a space if the average temperature is 1000° or above. Average temperatures up to 999.9° use all 5 characters. A total of 29 characters are sent out.

Table 2-2 shows a sample output. The headings at the top of the table explain the contents of each column (these are not part of the output).

Table 2-2: RUN Mode Output Example

°C or °F	Space Main Temp	Space E for Emissivity	Space Emissivity Value	Space Mode	Space Mode Temperature	Space HAL, LAL, or 3 Blank Spaces	Carriage Return	Line Feed	Notes (see below)
F	0072	E	0 . 95	MAX	0072		<CR>	<LF>	
F	0073	E	0 . 95	MAX	0073		<CR>	<LF>	
F	0090	E	0 . 95	MAX	0090		<CR>	<LF>	
F	0070	E	0 . 95	MAX	0090		<CR>	<LF>	
F	0071	E	0 . 95	MAX	0090	HAL	<CR>	<LF>	1
F	0081	E	0 . 95	MAX	0090		<CR>	<LF>	
F	0080	E	0 . 95	MAX	0090		<CR>	<LF>	
F	0070	E	0 . 95	MIN	0070		<CR>	<LF>	2
F	0070	E	0 . 95	DIF	0020		<CR>	<LF>	3
F	0081	E	0 . 95	AVG	088.4		<CR>	<LF>	4
F	-018	E	0 . 95	AVG	-11.5		<CR>	<LF>	5
F	0421	E	0 . 95	AVG	100.0		<CR>	<LF>	6
F	1480	E	0 . 95	AVG	999.9		<CR>	<LF>	7
F	1900	E	0 . 95	AVG	1000		<CR>	<LF>	8
F	0071	E	0 . 95	MAX	0090		<CR>	<LF>	
F	0081	E	0 . 95	MIN	-018	LAL	<CR>	<LF>	9
F	0081	E	0 . 95	MIN	-018		<CR>	<LF>	
C	0027	E	0 . 95	MIN	-028		<CR>	<LF>	10
C	0027	E	1 . 00	MIN	-028		<CR>	<LF>	11

Notes:

1. Indicates HAL is active and temperature HAL value.
2. Mode changed to MIN.
3. Mode changed to DIF.
4. Mode changed to AVG.
5. Main and Average temperatures went negative.
6. Average temperature goes positive and is 100°F.
7. Average temperature is up to 999.9°F.
8. Average temperature is now greater than 999.9°F so decimal point is no longer displayed.
9. Indicates LAL is active and temperature LAL value.
10. Scale is changed from °F to °C.
11. Emissivity is changed to 1.00.

2.6.1.2 Data Output-SET Loop

After entering the SET loop (SET icon activated), setup parameters can be sent out by pressing the SET button again. This information can be sent out at any time while still in the SET loop. Unactivated setpoints are printed in lowercase (e.g., hal) and activated setpoints are printed in uppercase (e.g., HAL). Hi Alarm, Low Alarm, T. Ambient, Temperature Scale, and DOI are sent out and terminated by a carriage return and line feed. A total of 39 characters are sent out. The SET values will be printed any time you press the SET button. Two examples follow:

```
hal 0085 lal 0065 tam 0100 F;DOI 3600<CR><LF> (hal, lal, tam not activated)
```

```
HAL 0085 lal 0065 tam 0100 F;DOI 3600<CR><LF> (HAL activated)
```

The above lines indicate Hi Alarm = 85, Low Alarm = 65, T. Ambient = 100, the temperature scale is °F, and DOI = 3600 seconds. (The <CR> and <LF> do not print; these denote the carriage return and line feed.)

Note: DOI does not apply to the SETUP mode.

2.6.1.3 Data Output LOG Run Loop

When you press the trigger (first stage only) in the LOG Loop, data will be sent out only for those locations that have stored data. The temperature scale, stored main temperature, stored emissivity, stored MAX temperature, location number, HAL, a carriage return, and a line feed are sent out when the trigger is pressed. HAL is sent out if the stored temperature is above or equal to the HAL value for that location, and HAL is activated. Three spaces replace HAL if this condition is not satisfied. A total of 32 characters are sent out.

Table 2-3 shows a sample output. The headings at the top of the table explain the contents of each column (these are not part of the output).

Table 2-3: LOG Run Mode Output Example

°C or °F	Space Main Temp	Space E for Emissivity	Space Emissivity Value	Space MAX Mode	Space Stored MAX Temperature	Space Location Number	Space HAL	Carriage Return	Line Feed	Notes (see below)
F	0072	E	0 . 95	MAX	0090	001		<CR>	<LF>	1
F	0095	E	1 . 00	MAX	0100	006		<CR>	<LF>	2
F	0070	E	0 . 95	MAX	0090	007	HAL	<CR>	<LF>	3
F	0090	E	0 . 97	MAX	0100	100		<CR>	<LF>	

Notes:

1. Current and MAX temperature stored at Location 1.
2. Current and MAX temperature stored, and the emissivity changed to 1.00 at Location 6.
3. Current and MAX temperature stored at Location 7, HAL is active, and the stored temperature is HAL value. When the 2-stage trigger is pulled all the way to store the current and maximum temperatures at Location 7, the current temperature also exceeded the HAL value, which was activated. Therefore, HAL was sent out at the end of the string.

Notes: Note that in the above example nothing was stored at locations 2, 3, 4, 5, and 8 through 99, so these locations were not sent out. There will be a pause in printing between locations 1 and 6 and between locations 7 and 100 because the unit is searching through the locations sequentially for stored data.

DOI does not apply to the LOG mode.

2.6.1.4 Data Output-LOG SETUP Loop

After entering the LOG SETUP loop (both the LOG and SET icons are activated), setup parameters are sent out **when the SET button is pressed again**. This information can be sent out at any time in the LOG SETUP mode. HAL, temperature scale, and the location number are sent out and terminated by a carriage return and line feed. A total of 16 characters are sent out. Go to the appropriate location number in the LOG loop and press the SET button to send out the Hi Alarm value for that location. Activated Hi Alarm locations are uppercase (HAL), and unactivated Hi Alarm locations are lowercase (hal). Only the HAL value at the present location is sent out. For additional HAL values, go to the appropriate location and press SET again while still in any of the two screens in the LOG SETUP mode. **To get the LOG SETUP parameters for all 100 log locations, press the SET button for about 3 seconds.**

Table 2-4 shows a sample output. The headings at the top of the table explain the contents of each column (these are not part of the output).

Table 2-4: LOG SETUP Mode Output Example

hal or HAL	S p a c e	HAL Value	S p a c e	°C or °F	S p a c e	Location Number	Carriage Return	Line Feed	Notes (see below)
hal		1000		F		001	<CR>	<LF>	1
HAL		1000		F		002	<CR>	<LF>	2
hal		0085		F		003	<CR>	<LF>	3
hal		0085		F		004	<CR>	<LF>	3
hal		0085		F		005	<CR>	<LF>	3
hal		0085		F		006	<CR>	<LF>	3
hal		0085		F		007	<CR>	<LF>	3
HAL		0065		F		008	<CR>	<LF>	4

Notes:

1. For Location 1, HAL is not activated and is 1000°F.
2. For Location 2, HAL is activated and is 1000°F.
3. For Locations 3, 4, 5, 6, and 7, HAL is not activated and is 85°F.
4. For Location 8, HAL is activated and is 65°F.

Note: DOI does not apply to the LOG SETUP mode.

2.6.2 Analog Output

The analog output is made up of the following:

- Output: 1 mV/° (°C or °F) for all models except 1M
1 mV/°C or 0.5 mV/°F for the 1M
- Output impedance: 1.3 K Ω

Use the signal output jack accessory.

The analog output represents the current temperature of the object being measured, regardless of the mode used. If T_{amb} compensation is activated, the analog output will be representative of the compensated temperature values.

2.7 SIGHTING SYSTEMS

The aiming options for this instrument are laser(s), scope, or laser and scope combination. Laser sighting is available in single or dual spot models or in a crossed laser model.

Two different laser power levels are available for this product. Please refer to the label on your unit and to the following label diagrams (Figure 2-13) to determine the one that you have. The following table shows the specifications for both laser types.

Table 2-5: Laser Specifications

	FDA Class IIIa	FDA Class II and IEC Class 2
Type	Gallium Arsenide	Gallium Arsenide
Wavelength	630-670 nm	630-670 nm
Power	<5 milliwatt	<1 milliwatt
Operating Range (depending on ambient light level)	Up to 30 m (100 ft)	Up to 15 m (50 ft)

CAUTION

Use of controls or adjustments, or performance of procedures other than those specified herein, may result in hazardous laser radiation exposure.

WARNING-LASER SAFETY

Models with laser sighting produce visible laser radiation that may be harmful to the human eye. Be aware of the following:

- **Avoid direct exposure of human eyes to laser light. Eye damage can result.**
 - **Use extreme caution when operating.**
 - **Never point the unit at another person.**
 - **Keep out of the reach of children.**
 - **Refer to the FDA laser label on the unit for specific information.**
-

To operate the laser, do the following:

1. Point the instrument toward the spot being measured. (Do not point it at anyone.)
2. Pull the trigger.
3. Press the Laser button on the control panel.
4. Aim accordingly. (Refer to the following sections for laser aiming information.)

Note: The laser turns off automatically when the trigger is released. It cannot be locked on when the trigger is locked. It cannot be turned on in the Recall and Setup loops.

FDA Class II



FDA Class IIIa



IEC Class 2

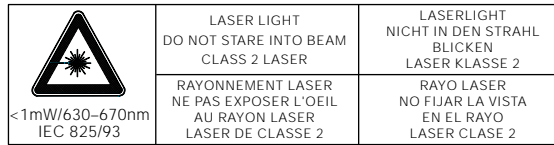

Figure 2-13: Laser Labels

2.7.1 Single Laser Sighting

A single laser unit (see Figure 2-14) indicates the center of the area being measured, not the diameter of the spot. (To find out the diameter of the spot being measured, refer to the optical charts in Appendix A.)



Figure 2-14: Single Laser Sighting

2.7.2 Dual Laser Sighting

A dual laser unit indicates the diameter of the spot being measured. To take a measurement, aim the unit at the target and move closer or farther until the target is within the laser dots.

Note: The IR and laser spot diameters are not the same at close distances. The distance between the laser beams is slightly greater than the spot being measured. Refer to Figure 2-15 for a comparison of the IR spot and laser beam diameters.

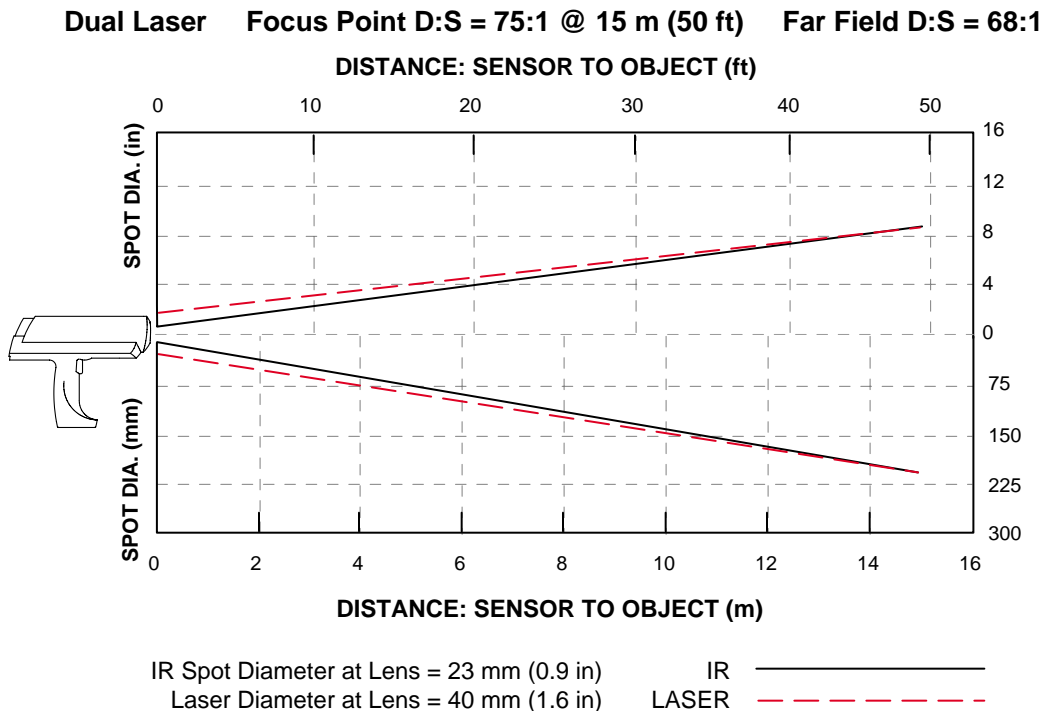

Figure 2-15: Dual Laser and IR Spot Diameters

2.7.3 Crossed Laser Sighting

The distance at which the two laser dots overlap is the point where the smallest area is measured (Focus Point). To find this distance, aim the unit at the target and move closer or farther until the laser beams overlap. Refer to Figure 2-16 for a comparison of the IR spot and laser beam diameters.

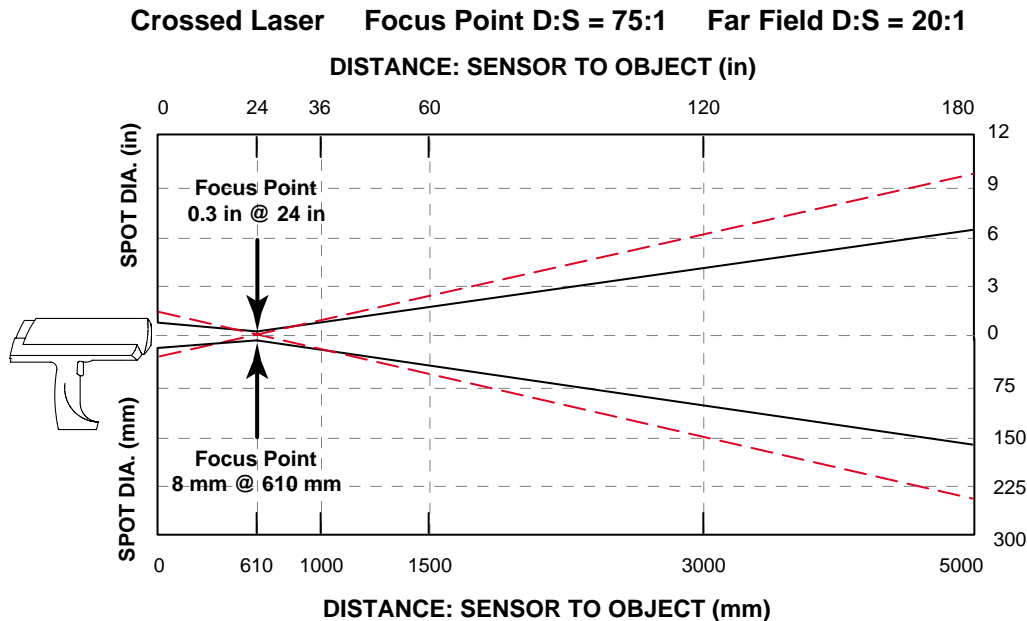

Figure 2-16: Crossed Laser and IR Spot Diameters

2.7.4 Scope Sighting

Scope sighting models (Figure 2-17) have parallax-free sighting (at the focus distance). Look through the scope. There are one or two circular reticles, depending on model. The inner reticle indicates the area that is measured at the focus point (see Appendix A for the focus point distance for your model). The outer reticle indicates an area greater than or equal to the area that is measured at all other distances.

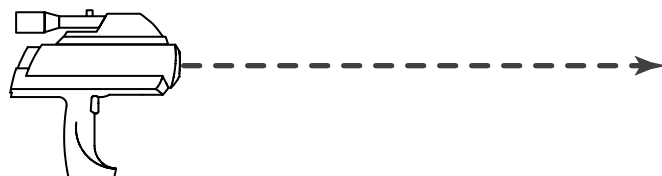

Figure 2-17: Scope Sighting

2.7.5 Scope with Laser Sighting

The scope and single laser sighting model (Figure 2-18) combines the parallax-free sighting of the scope with the convenience of the laser. The combination unit has a single class 2 laser. It indicates the center of the target being measured, not the diameter of the spot being measured. See section 2.7.1 and Figure 2-14 for further details on the laser. The scope has one reticle and it indicates the target area that is measured at the focus point (see Appendix A for the focus point distance of your model). See section 2.7.4 and Figure 2-17 for further details on the scope.

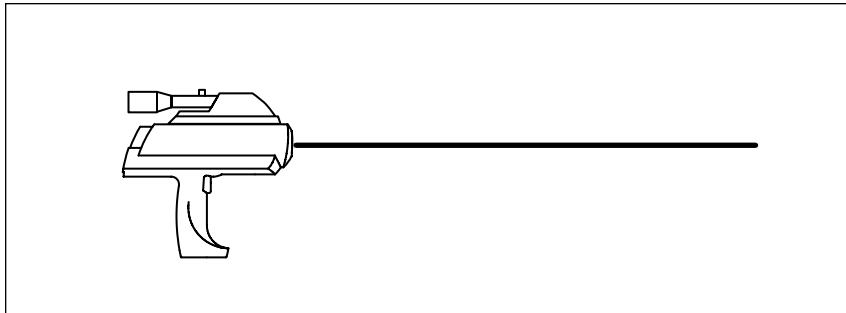

Figure 2-18: Scope with Laser Sighting

3.0 SPECIFICATIONS

This section covers the following specifications:

- Thermal
- Operational
- Electrical
- Environmental
- Physical

Also covered are factory default settings for each model as well as factory default settings and range values for all models.

3.1 THERMAL

Table 3-1 lists thermal specifications for each model.

Table 3-1: Thermal Specifications

	LT, LR, LRSCL2	1M	2M	G5	P7
Measurement Range	-30 to 1200°C (-20 to 2200°F)	600 to 3000°C (1100 to 5400°F)	200 to 1800°C (400 to 3275°F)	150 to 1800°C (300 to 3275°F)	10 to 800°C (50 to 1450°F)
Spectral Response	8 to 14 micron	1.0 micron	1.6 micron	5 micron	7.9 micron
Detecting Element	Thermopile	Silicon diode	InGaAs diode	Thermopile	Thermopile
Display Accuracy	±1% of reading (±0.5% for 1M) or ±1°C (±1.5°F), whichever is greater, or ±2°C (±4°F) for targets below 0°C (32°F), at 23°C ±5°C (73°F ±9°F) ambient operating temp.				
Analog Output Accuracy	±3mV of display reading				
Repeatability	±0.5% of reading or ±1°C (±1°F), whichever is greater				
Temperature Coefficient	±0.1°C (±0.1°F) change per 1°C (1°F) change in ambient temperature				

* The instrument may measure temperature a few degrees below the minimum and above the maximum specified temperature range.

Note: Hi Alarm, Lo Alarm, and T. Ambient ranges are the same as measurement ranges in Table 3-1.

3.2 OPERATIONAL

Table 3-2 lists operational specifications for each model.

Table 3-2: Operational Specifications

	LT, LR, LRSCL2	1M	2M	G5	P7
Temperature Display	°C or °F (selectable), multifunctional 4-digit backlit LCD				
Display and Digital Output Resolution	1°C or 1°F (0.1°C or 0.1°F in AVG Mode for temperatures up to 999.9°)				
Display Controls	Membrane Switch Panel				
Emissivity	Adjustable from 0.10 to 1.00 in 0.01 increments (default = 0.95)				
DOI (Digital Output Interval)	1 to 9999 seconds				
Analog Output Resolution	1°C or 1°F				
LOG Locations	1 to 100				
Response Time (95% response)	700 msec	550 msec	550 msec	700 msec	700 msec

3.3 ELECTRICAL

Table 3-3 lists electrical specifications for each model.

Table 3-3: Electrical Specifications

	LT, LR, LRSCL2	1M	2M	G5	P7
Analog Output	1mV/°C (1mV/°F)	1mV/°C (0.5mV/°F)	1mV/°C (1mV/°F)		
Analog Output Range	Same as Measurement Range in Table 3-1				
Analog Output Impedance	1.3 KΩ				
Digital Output	RS232, 9600 baud				
Digital Output Range	Same as Measurement Range in Table 3-1				
Power Requirements	Four (4) AA alkaline or rechargeable batteries or 6 to 9 volt, 200 mA, DC power supply				

3.4 ENVIRONMENTAL

Table 3-4 lists environmental specifications for each model.

Table 3-4: Environmental Specifications

	LT, LR, LRSCL2	1M	2M	G5	P7
Relative Humidity	10 to 95% at up to 30°C (86°F) under non-condensing conditions				
Storage Temperature	-20 to 50°C (-4 to 120°F) without battery				
Ambient Operating Temperature	0 to 50°C (32 to 120°F)				

Note: The laser will turn off automatically if the instrument's internal temperature exceeds 45° C (113° F).

3.5 PHYSICAL

Table 3-5 lists environmental specifications for each model.

Table 3-5: Physical Specifications

	LASER MODELS	SCOPE MODELS	SCOPE & LASER
	208 mm (8.2 in) H 257 mm (10.1 in) L 71 mm (2.8 in) W	244 mm (9.6 in) H 257 mm (10.1 in) L 71 mm (2.8 in) W	244 mm (9.6 in) H 257 mm (10.1 in) L 71 mm (2.8 in) W
	794 g (1.75 lbs)	1000 g (2.21 lbs)	1000 g (2.21 lbs)

3.6 DEFAULT VALUES

Table 3-6 lists the factory default values for each model.

Table 3-6: Model Specific Factory Default Values

	Hi Alarm	Lo Alarm	T. Ambient
LTDL, LTCL, LTSC, LRSC, LRL, LRSCL2	1200°C (2200°F)	0°C (0°F)	23°C (73°F)
1MSC, 1ML	3000°C (5400°F)	600°C (1100°F)	600°C (1100°F)
P7DL	800°C (1450°F)	10°C (50°F)	23°C (73°F)
G5SC	1800°C (3275°F)	150°C (300°F)	150°C (300°F)
2MSC, 2ML	1800°C (3275°F)	200°C (400°F)	200°C (400°F)

Table 3-7 lists factory default settings that are valid for all models.

Table 3-7: Non-Model Specific Factory Default Values

Function	Default
Emissivity	0.95
DOI (Digital Output Interval)	60 seconds
Digital/Analog Output	Analog Output
Trigger LOCK	off
Laser	off
Backlight	off
HAL	off
LAL	off
TAM	off
Scale: U.S.	degrees F
Scale: Outside U.S.	degrees C
Loop	RUN Loop, MAX Mode
Setup Screen (RUN Loop)	F/C
Setup Screen (LOG Loop)	LOC (Location)
LOG Location	1
LOG Data—All Locations	
Current Temperature	0 degrees C, or 0 degrees F
MAX Temperature	0 degrees C, or 0 degrees F
Hi Alarm Value	See Table 3-6
Hi Alarm State	off
Emissivity	0.95

Note: When you simultaneously press the MODE and ACTIVATE buttons while in the RUN loop, the instrument is reset to its RUN loop factory default settings (stored data is unaffected). In the LOG loop, pressing the MODE and ACTIVATE buttons not only resets the instrument to its LOG loop factory default settings, but also clears all previously stored data. In both cases, the instrument will “beep” after reinstalling the default settings. Section 3.6 lists default setting for each model as well as non-model-specific default settings and range values.

3.7 REGULATORY

The appropriate regulatory approvals and certificates have been issued as follows:

- FDA Class II Laser Certification
- FDA Class IIIa Laser Certification
- IEC Class 2 Laser Certification
- IEC801-3 (EN50082) for EMI susceptibility

4.0 MAINTENANCE

4.1 BATTERY REPLACEMENT

When the battery icon comes on, you need to replace the batteries. To open the battery compartment, press gently on the middle of the sliding panel (located on the bottom of the handle) and slide it to the rear of the unit. Remove the batteries and replace with four AA batteries. Be sure to insert the new batteries so they point in the proper direction. (A symbol on the side of the handle shows the proper battery orientation.) Replace the battery compartment cover.

4.2 CLEANING

You should periodically clean the instrument's front window and housing.

4.2.1 Front Window Cleaning

A dirty front window can cause temperature measurement errors. The window is fragile, and care should be taken when cleaning it to prevent scratching. Use camera lens or eye glass tissues to clean the window.

Periodic cleaning can be done by completing one or more of the following:

- Blow loose particles off the front window with clean air.

Note: Unfiltered compressed air, as well as your own breath, can cause condensation on the front window, which can trap dust particles instead of removing them.

- Gently brush off particles with a soft camel-hair brush.
- Thicker contaminants can be cleaned with water and a camera lens tissue.
- For finger prints or grease, use either isopropyl alcohol, Ethanol, Xylene, Acetone, or Kodak® Lens Cleaner. Apply to the front window, and wipe gently with a camera lens tissue until you see colors on the surface, then allow to air dry. Do not wipe the surface dry, as this may scratch the surface.

CAUTION

Do not use any ammonia, or cleaners with ammonia, bleach, acids, or strong bases. This can cause severe damage to the front window.

4.2.2 Cleaning the Housing

To clean the instrument's housing, simply use soap and water or a mild commercial cleaner. Wipe with a damp sponge or soft rag. Use a soft rag to gently wipe the display.

4.3 LASER MAINTENANCE

If the laser (laser models only) does not operate properly, call your infrared thermometer supplier. **DO NOT** open the instrument's main housing.

APPENDIX A: OPTICAL

HOW TO READ THE OPTICAL CHARTS

The optical charts indicate the nominal target spot diameter at various distances from the sensing head. Information on the top line of each chart shows the different spot diameters at the distances from the sensor given on the bottom line (see Figure A-1). All measurements are in millimeters or meters and inches.

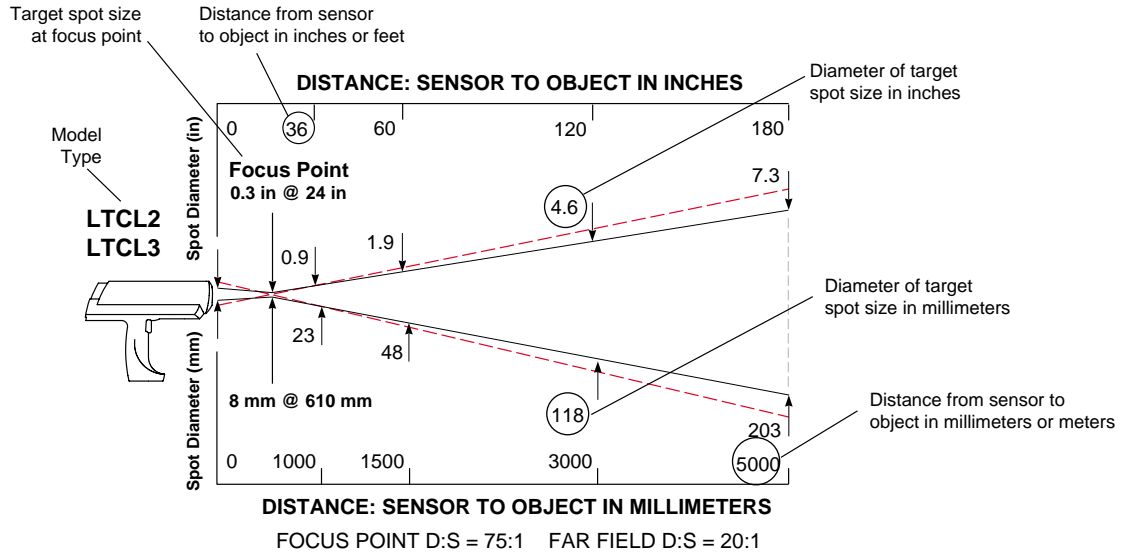

IR Spot Diameter at Lens = 23 mm (0.9 in) IR Beam Profile —————
 Laser Diameter at Lens = 40 mm (1.6 in) Laser Profile - - - - -

Focus Point D:S = Distance to spot divided by spot diameter at the focus point
Far Field D:S = Ratio at distances greater than 10x the focus distance

How to calculate spot sizes

To calculate a spot size between two known points on an optical chart, use the following formula:

$$S_x = S_n + \left[\frac{(D_x - D_n)}{(D_f - D_n)} \times (S_f - S_n) \right]$$

S_x = Unknown spot size
 S_n = Smaller known spot size
 S_f = Larger known spot size
 D_x = Distance to unknown spot
 D_n = Distance to smaller known spot
 D_f = Distance to larger known spot

Figure A-1: How to Read the Optical Charts

OPTICAL CHARTS

Note that the optical resolution values are stated at minimum 90% energy (95% for 1M).

Figure A-2: Optical Charts

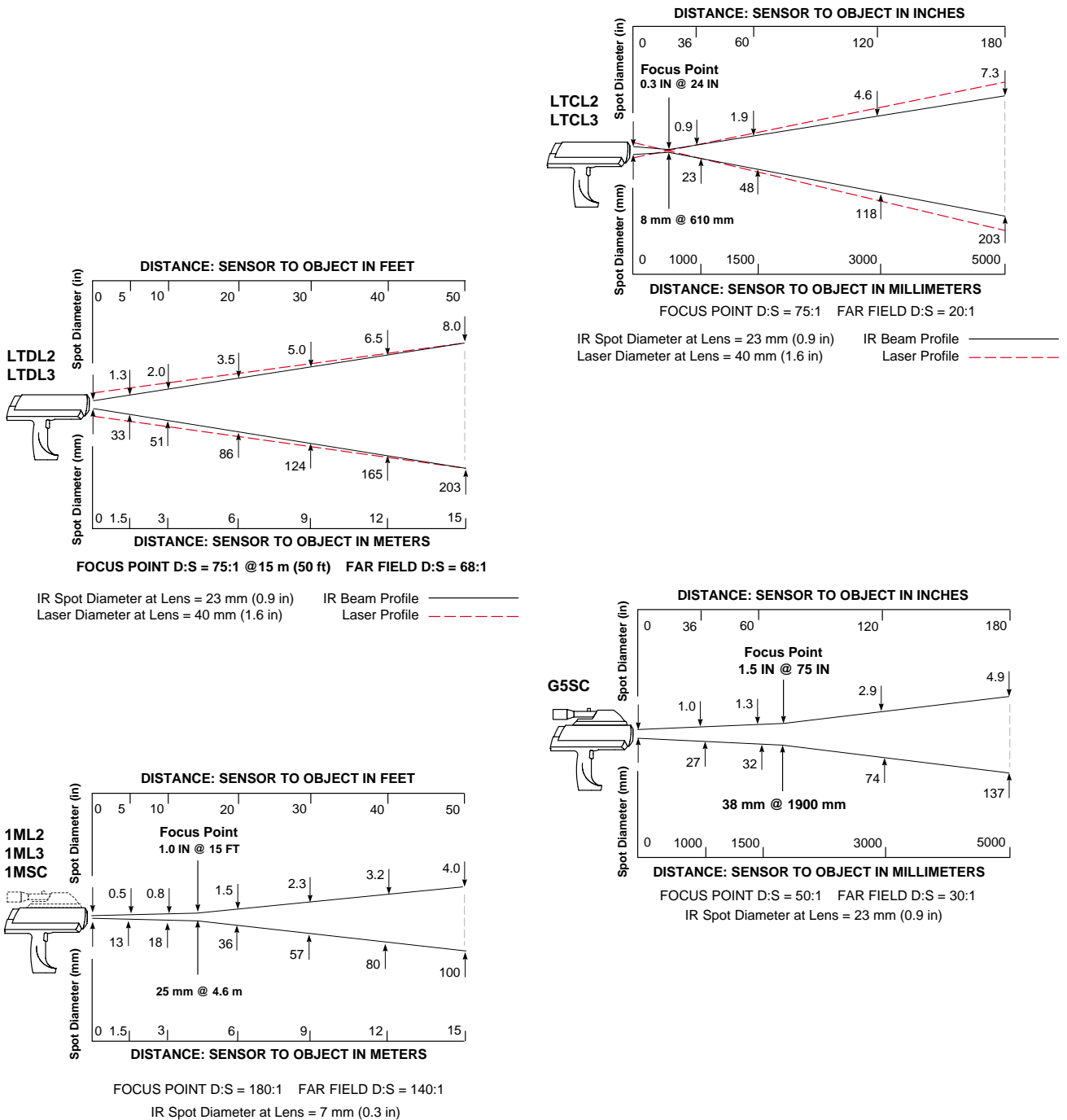

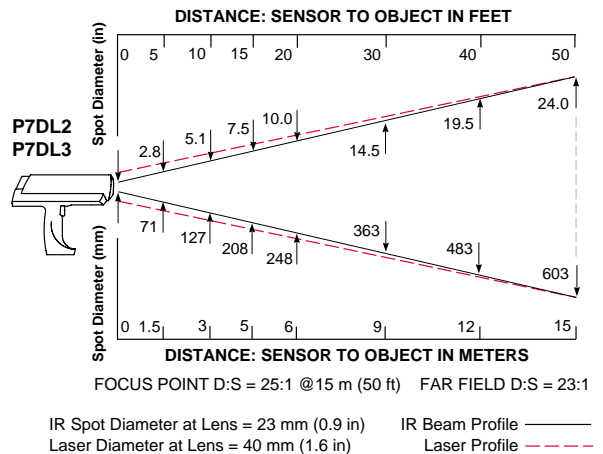
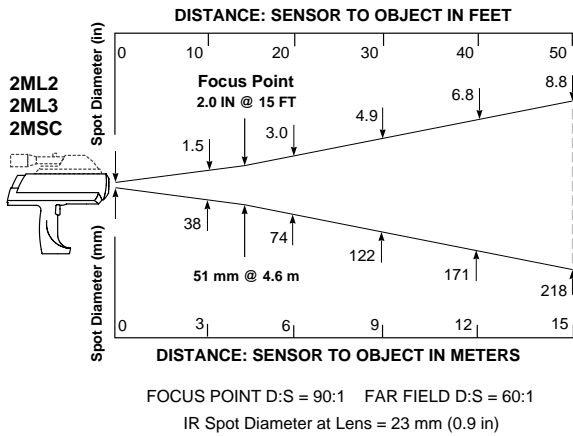
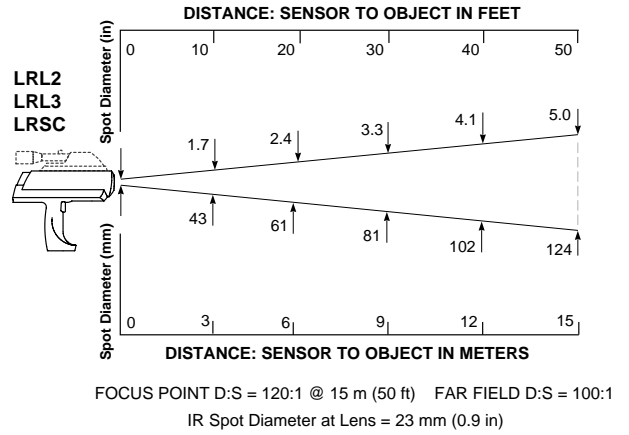
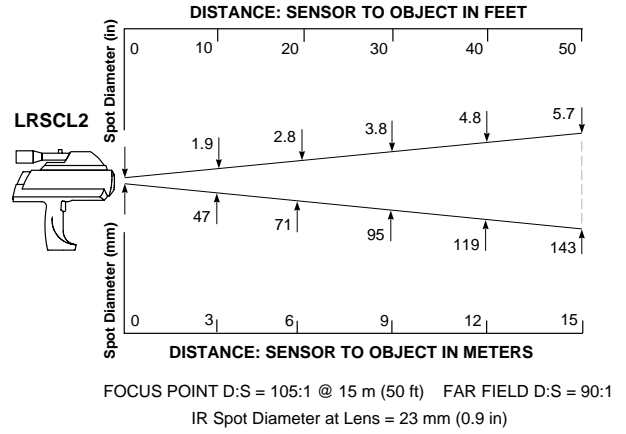
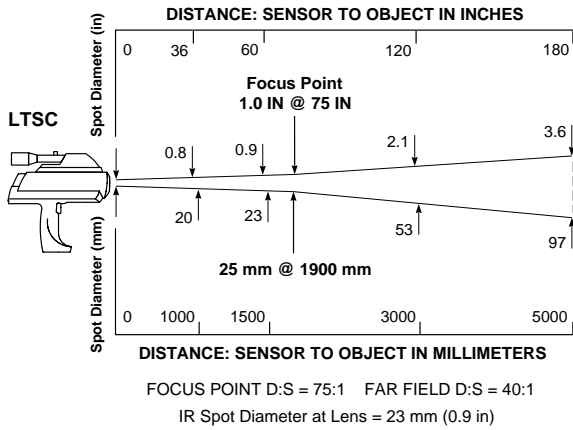

APPENDIX B: OBJECT EMISSIVITY

HOW TO DETERMINE OBJECT EMISSIVITY

Emissivity is a measure of an object's ability to absorb, transmit, and emit infrared energy. It can have a value from 0.0 (perfect mirror) to 1.0 (blackbody). When setting the emissivity value on your sensor, if you set a higher than actual emissivity value, the output will read low (provided the target temperature is above the local's ambient temperature). For example, if you set 0.95 and the actual target emissivity is 0.9, the sensor's reading will be lower than the target's true temperature (when the target temperature is above ambient).

To determine an object's emissivity, you can use any one of the following methods:

1. Determine the actual temperature of the object using a sensor such as a Resistance Temperature Device (RTD), thermocouple, or another suitable method. Next, use your portable sensor to measure the object temperature and adjust the emissivity setting until it shows the actual temperature. This is the correct emissivity for the measured material.
2. For objects with relatively low temperatures, up to 260°C (500°F), place a piece of tape, such as masking, on the object. Make sure the tape is large enough for the measurement spot diameter. You do not want the spot to go beyond the tape's edges. Next, measure the tape temperature using an emissivity setting of 0.95. Finally, measure an adjacent area on the object and adjust the emissivity setting until you reach the same temperature. This is the correct emissivity for the measured material.
3. If a portion of the surface of the object can be coated, use a flat black paint. Next, measure the painted area using an emissivity setting of 0.93. Finally, measure an adjacent area on the object and adjust the emissivity setting until you reach the same temperature. This is the correct emissivity for the measured material.

TYPICAL EMISSIVITY VALUES

The following tables provide references for estimating emissivity and can be used when none of the previous three determining steps are practical. Emissivity values shown in the tables are only approximate. Any or all of the following parameters can affect the emissivity of an object:

1. Temperature
2. Angle of measurement
3. Geometry (plane, concave, convex, etc.)
4. Thickness
5. Surface quality (polished, rough, oxidized, sandblasted)
6. Spectral region of measurement
7. Transmissivity (i.e., thin film plastics)

Table B-1: Emissivity Values for Metals

Material	Emissivity		
	1.0 μ m	1.6 μ m	8-14 μ m
Aluminum			
Unoxidized	0.1-0.2	0.02-0.2	n.r.
Oxidized	0.4	0.4	0.2-0.4
Alloy A3003,			
Oxidized	n.r.	0.4	0.3
Roughened	0.2-0.8	0.2-0.6	0.1-0.3
Polished	0.1-0.2	0.02-0.1	n.r.
Brass			
Polished	0.8-0.95	0.01-0.05	n.r.
Burnished	n.r.	n.r.	0.3
Oxidized	0.6	0.6	0.5
Chromium	0.4	0.4	n.r.
Copper			
Polished	n.r.	0.03	n.r.
Roughened	n.r.	0.05-0.2	n.r.
Oxidized	0.2-0.8	0.2-0.9	0.4-0.8
Electrical Terminal Blocks	n.r.	n.r.	0.6
Gold	0.3	0.01-0.1	n.r.
Haynes			
Alloy	0.5-0.9	0.6-0.9	0.3-0.8
Inconel			
Oxidized	0.4-0.9	0.6-0.9	0.7-0.95
Sandblasted	0.3-0.4	0.3-0.6	0.3-0.6
Electropolished	0.2-0.5	0.25	0.15

n.r. = not recommended

Continued on next page

Table B-1 (continued): Emissivity Values for Metals

Material	Emissivity		
	1.0 μ m	1.6 μ m	8-14 μ m
Iron			
Oxidized	0.4-0.8	0.5-0.9	0.5-0.9
Unoxidized	0.35	0.1-0.3	n.r.
Rusted	n.r.	0.6-0.9	0.5-0.7
Molten	0.35	0.4-0.6	n.r.
Iron, Cast			
Oxidized	0.7-0.9	0.7-0.9	0.6-0.95
Unoxidized	0.35	0.3	0.2
Molten	0.35	0.3-0.4	0.2-0.3
Iron, Wrought			
Dull	0.9	0.9	0.9
Lead			
Polished	0.35	0.05-0.2	n.r.
Rough	0.65	0.6	0.4
Oxidized	n.r.	0.3-0.7	0.2-0.6
Magnesium	0.3-0.8	0.05-0.3	n.r.
Mercury	n.r.	0.05-0.15	n.r.
Molybdenum			
Oxidized	0.5-0.9	0.4-0.9	0.2-0.6
Unoxidized	0.25-0.35	0.1-0.35	0.1
Monel (Ni-Cu)	0.3	0.2-0.6	0.1-0.14
Nickel			
Oxidized	0.8-0.9	0.4-0.7	0.2-0.5
Electrolytic	0.2-0.4	0.1-0.3	n.r.
Platinum			
Black	n.r.	0.95	0.9
Silver	n.r.	0.02	n.r.
Steel			
Cold-Rolled	0.8-0.9	0.8-0.9	0.7-0.9
Ground Sheet	n.r.	n.r.	0.4-0.6
Polished Sheet	0.35	0.25	0.1
Molten	0.35	0.25-0.4	n.r.
Oxidized	0.8-0.9	0.8-0.9	0.7-0.9
Stainless	0.35	0.2-0.9	0.1-0.8
Tin (Unoxidized)	0.25	0.1-0.3	n.r.
Titanium			
Polished	0.5-0.75	0.3-0.5	n.r.
Oxidized	n.r.	0.6-0.8	0.5-0.6
Tungsten	n.r.	0.1-0.6	n.r.
Polished	0.35-0.4	0.1-0.3	n.r.
Zinc			
Oxidized	0.6	0.15	0.1
Polished	0.5	0.05	n.r.

n.r. = not recommended

Table B-2: Emissivity Values for Non-Metals

	1.0 μ m	5.0 μ m	7.9 μ m	8-14 μ m
Asbestos	0.9	0.9	0.95	0.95
Asphalt	n.r.	0.95	0.95	0.95
Basalt	n.r.	0.7	0.7	0.7
Carbon				
Unoxidized	0.8-0.95	0.8-0.9	0.8-0.9	0.8-0.9
Graphite	0.8-0.9	0.7-0.9	0.7-0.8	0.7-0.8
Carborundum	n.r.	0.9	0.9	0.9
Ceramic	0.4	0.85-0.95	0.95	0.95
Clay	n.r.	0.85-0.95	0.95	0.95
Concrete	0.65	0.9	0.95	0.95
Cloth	n.r.	0.95	0.95	0.95
Glass				
Plate	n.r.	0.98	0.85	0.85
" Gob"	n.r.	0.9	n.r.	n.r.
Gravel	n.r.	0.95	0.95	0.95
Gypsum	n.r.	0.4-0.97	0.8-0.95	0.8-0.95
Ice	n.r.	—	0.98	0.98
Limestone	n.r.	0.4-0.98	0.98	0.98
Paint (non-Al.)		—	0.9-0.95	0.9-0.95
Paper (any color)	n.r.	0.95	0.95	0.95
Plastic (opaque, over 20 mils)	n.r.	0.95	0.95	0.95
Rubber	n.r.	0.9	0.95	0.95
Sand	n.r.	0.9	0.9	0.9
Snow	n.r.	—	0.9	0.9
Soil	n.r.	—	0.9-0.98	0.9-0.98
Water	n.r.	—	0.93	0.93
Wood, Natural	n.r.	0.9-0.95	0.9-0.95	0.9-0.95

n.r. = not recommended

To optimize surface temperature measurement accuracy consider the following:

1. Determine the object emissivity for the spectral range of the instrument to be used for the measurement.
2. Avoid reflections by shielding object from surrounding high temperature sources.
3. For higher temperature objects use shorter wavelength instruments, whenever possible.
4. For semi-transparent materials such as plastic film and glass, assure that the background is uniform and lower in temperature than the object.
5. Hold instrument perpendicular to surface whenever emissivity is less than 0.9. In all cases, do not exceed angles more than 30 degrees from incidence.
6. For 1M and 2M models, avoid measurements in high ambient light conditions (see Page 2-11).

APPENDIX C: TROUBLESHOOTING

The portable instrument is equipped with a failsafe program that lets you know if it is over or under range while in the MAX, MIN, DIF, or AVG modes. The failsafe program also lets you know the instrument has a failed component. All failsafe information displays on the control panel and is sent to the RS-232 and analog outputs.

Figure C-1 shows how the control panel displays the over range and under range failsafe codes.

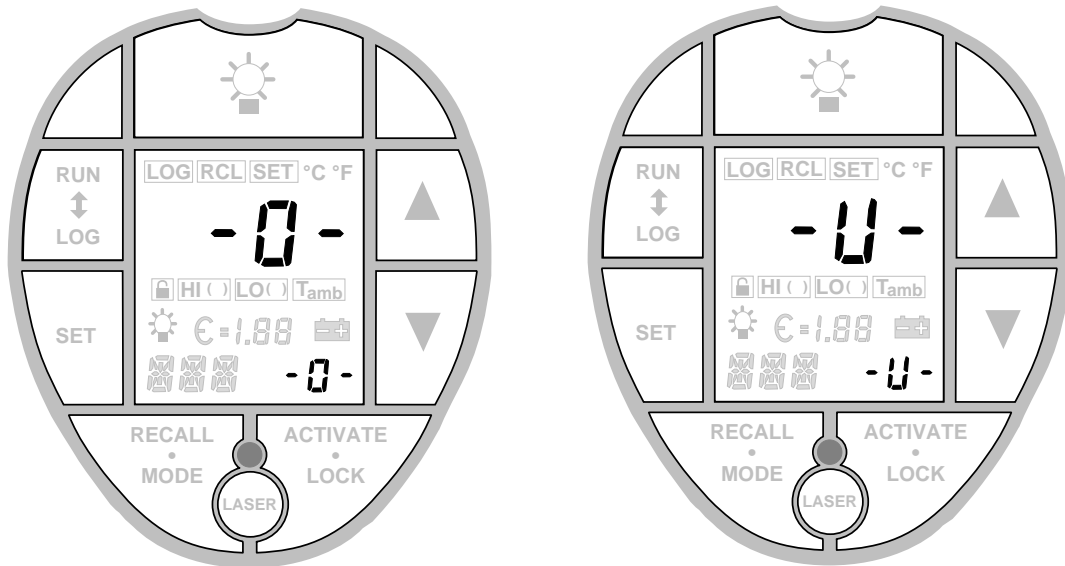

Figure C-1: Over and Under Range Failsafe Codes

MAX Mode: If the object's temperature is over range, the panel's main and mode displays and RS-232 output are sent the -O- failsafe code. The analog output is sent the maximum temperature for your model.

If the object's temperature is under range, the panel's main display and RS-232 output are sent the -U- failsafe code. The mode display and RS-232 output are sent either the correct MAX temperature or the -U- failsafe code. The analog output is sent the minimum temperature for your model.

MIN Mode: If the object's temperature is over range, the panel's main display and RS-232 output are sent the -O- failsafe code. The mode display and RS-232 output are sent either the correct MIN temperature or the -O- failsafe code. The analog output is sent the maximum temperature for your model.

If the object's temperature is under range, the panel's main and mode displays and RS-232 output are sent the -U- failsafe code. The analog output is sent the minimum temperature for your model.

DIF Mode: If the object's temperature is over range, the panel's main and mode displays and RS-232 output are sent the -O- failsafe code. The analog output is sent the maximum temperature for your model.

If the object's temperature is under range, the panel's main and mode displays and RS-232 output are sent the -U- failsafe code. The analog output is sent the minimum temperature for your model.

AVG Mode: If the object's temperature is over range, the panel's main and mode displays and RS-232 output are sent the -O- failsafe code. The analog output is sent the maximum temperature for your model.

If the object's temperature is under range, the panel's main and mode displays and RS-232 output are sent the -U- failsafe code. The analog output is sent the minimum temperature for your model.

All Modes: If the internal temperature is less than 0°C or greater than 50°C, the panel's main and mode displays and the RS232 output are sent the -U- or -O- failsafe code respectively. The analog output is sent the minimum or maximum temperature for your model.

Note: On laser models, if the internal temperature is less than 0°C (32°F) or greater than 45°C (113°F), the laser will automatically turn off. The laser will also automatically turn off if the battery is too low (when the low battery icon displays).

FAILED COMPONENT

If the microprocessor fails, the panel's main and mode displays and RS-232 output are sent a 7777 failsafe code (see Figure C-2). The analog output is sent the maximum temperature for your model.

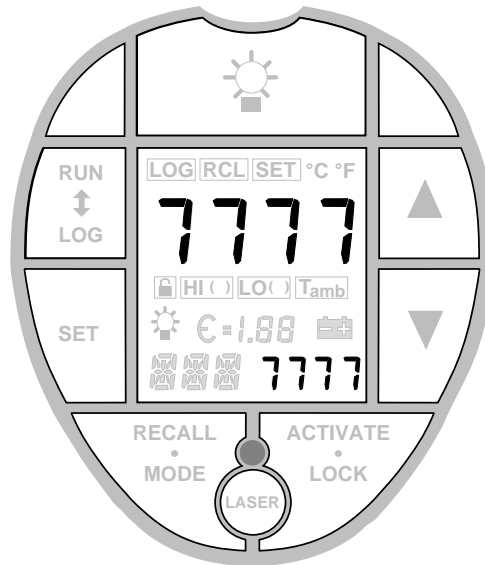

Figure C-2: Failed Component Failsafe Code

NOISY OR RANDOM READINGS OR SYSTEM LOCKUP

Noisy or random readings or a system lockup may be caused by electromagnetic interference from nearby unshielded equipment. To clear the instrument's system, release then press the trigger. If this does not clear the problem, slide the battery door off then back on. (This disconnects the battery power.)

APPENDIX D: OPTIONS AND ACCESSORIES

ACCESSORIES

A full range of accessories for various applications and industrial environments is available. Accessories may be ordered at any time and added on-site. The following accessories are available:

- Hard shell carrying case with die-cut foam interior
- Variable brightness filter (for scope models)
- DataTemp 2™ software for real-time graphic temperature display and datalogger downloading
- Portable/battery operated printer
- 110 V/60 Hz or 220 V/50 Hz voltage adaptors (DIN VDE 0551 approved)
- Computer cable 1.5 m (5 ft) w/9-pin connector and mini plug
- Printer cable 1.5 m (5 ft) w/25-pin connector and mini plug
- Analog cable 1.5 m (5 ft) w/banana plugs and mini plug
- Replacement operator's manual
- Laser glasses

OPTIONS

A full range of options for various applications and environments is available. Options are factory installed and must be ordered with base model units. The following options are available:

- NIST certification

APPENDIX E: TRACEABILITY OF INSTRUMENT CALIBRATION

The temperature sources (blackbodies) used to calibrate this instrument are traceable to the U.S. National Institute of Standards and Technology (NIST).

The calibration sources for this instrument were certified by a NIST certified calibration laboratory and are traceable to NIST primary standards. The certificate describes the equipment used for calibration and any corresponding NIST report numbers. In addition, the certificate lists test accuracy data and the next calibration date.

NIST certificates are available as an option (must be ordered with the instrument). Contact the manufacturer (not NIST) to order this option.

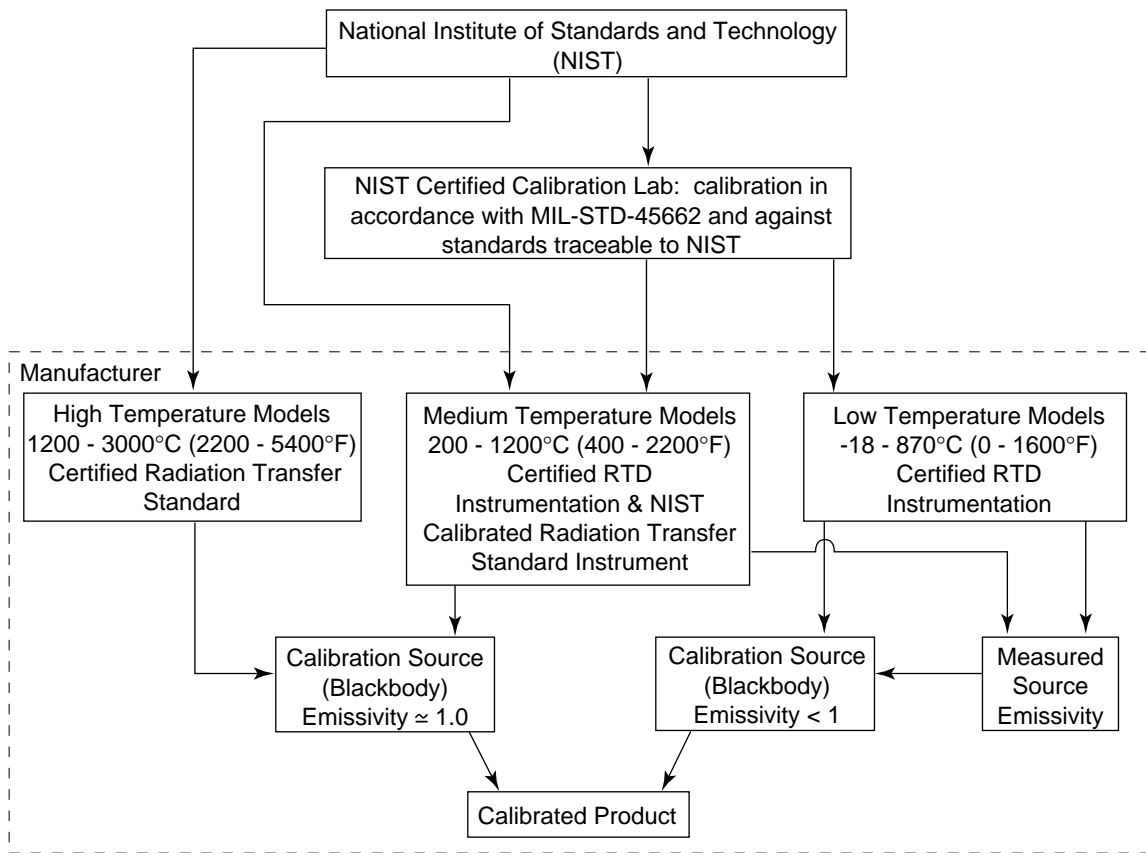

Figure E-1: Traceability Flowchart

APPENDIX F: CE CONFORMITY FOR THE EUROPEAN COMMUNITY



This instrument conforms to the following standards:

- EN50081-1:1992, Electromagnetic Emissions
- EN50082-1:1992, Electromagnetic Susceptibility

Tests were conducted over a frequency range of 27–500 MHz with the instrument in three orientations. The instrument's average error in this frequency range for the three orientations is 3.1° C at an electric field strength of 3 V/m. At some frequencies the instrument may not meet its stated accuracy.

Glossary Of Terms

Absolute Zero

The temperature (0 Kelvin) of an object defined by the theoretical condition where the object has zero energy.

Accuracy

Maximum deviation, expressed in temperature units, or as a percentage of the temperature reading, or as a percentage of the full scale temperature value, or as a percentage of the target temperature, indicating the difference between a temperature reading given by an instrument under ideal operating conditions, and the temperature of a calibration source (per the ASTM standard test method E 1256-88).

Activate

Pressing the activate button (available on various units) while in different modes can activate alarms and TAM, or toggle between digital and analog outputs or between °C and °F.

Ambient Derating

Refer to Temperature Coefficient.

Ambient Operating Range

Range of the ambient temperature conditions over which the thermometer is designed to operate.

Ambient Temperature

Room temperature or temperature surrounding the instrument.

Ambient Temperature Compensation (TAMB)

Refer to Reflected Energy Compensation.

ASTM

American Society for Testing and Materials.

Atmospheric Windows

Infrared spectral bands in which the atmosphere best transmits radiant energy. Two predominant windows are located at 2-5 μm and at 8-14 μm .

AVG

Average. Units with this feature have the ability to display the average of measured temperatures. AVG is a weighted average of all readings taken since the trigger was pulled.

Background Temperature

Temperature behind and surrounding the target, as viewed from the instrument.

Blackbody

A perfect emitter; an object that absorbs all the radiant energy incident on it at all wavelengths and reflects and transmits none. A surface with emissivity of unity (1.00).

°C (Celsius)

Temperature scale based on 0° (zero degrees) as the freezing point of water, and 100° as the vaporization point of water, at standard pressure. $^{\circ}\text{C} = (^{\circ}\text{F} - 32) \div 1.8$.

Calibration

A methodical measurement procedure to determine all the parameters significantly affecting an instrument's performance.

Calibration Source

A source (blackbody, hot plate, etc.) of known and traceable temperature and emissivity. Usually NIST traceable in the USA, with other recognized standards available for international customers.

Colored Body

See Non-Gray Body.

D:S

Distance to size ratio. See Optical Resolution.

Detector

Transducer which produces a voltage or current proportional to the IR energy incident upon it. See also thermopile, pyroelectric, and Si detectors.

Dielectric Withstand Voltage (Breakdown Voltage)

The voltage up to which a dielectric (insulator) can endure before conduction through the material occurs.

DIF

Differential. When this mode is activated, the difference between the temperatures of the last series of measured temperatures displays.

DIG/ANA

Digital/Analog switch. On units with this feature, a user can switch between digital and analog outputs.

Digital Data Bus

A means for transmitting coded digital data on a common buss in accordance with a standard format such as RS-232 or IEEE-488.

Digital Output Interval (DOI)

The time interval between variable length digital message transmissions containing temperature and system status information.

DIN

Deutsches Institut für Normung (DIN). The German standard for many instrumentation products.

Display Resolution

The level of precision to which a temperature value can be displayed, usually expressed in degrees or tenths of degrees.

Drift

The change in instrument indication over a long period of time, not caused by external influences on the device (per the ASTM standard test method E 1256-88).

EMC

Electro-Magnetic Compatibility. Resistance to electrical signal disturbances within IR thermometers.

Emissivity

The ratio of infrared energy radiated by an object at a given temperature and spectral band to the energy emitted by a perfect radiator (blackbody) at the same temperature and spectral band. The emissivity of a perfect blackbody is unity (1.00).

EMI/RFI Noise

Electro-Magnetic Interference/Radio Frequency Interference. EMI and RFI may cause disturbances to electrical signals within IR thermometers. EMI and RFI noise is most commonly caused by devices with switching motors (air conditioners, power tools, refrigeration systems, etc.).

°F (Fahrenheit)

Temperature scale where $^{\circ}\text{F} = (^{\circ}\text{C} \times 1.8) + 32$
 $= ^{\circ}\text{R} - 459.67$.

Far Field

A measured distance substantially greater than the focus distance of the instrument; typically greater than 10 times the focus distance.

Field of View (FOV)

The region, at the target, measured by the IR thermometer. Typically presented by giving the spot diameter as a function of distance from the instrument. Also presented as the angular size of the spot at the focus point. See Optical Resolution.

Filter (Optical)

Refer to Spectral Filter or Neutral Density Filter.

Focus Point (or Distance)

The distance from the instrument where the optical resolution is greatest.

Full Scale

The maximum of the temperature range or output signal.

Full Scale Accuracy

A convention for expressing the accuracy as a percentage of an instrument's (highest) full scale temperature.

Gray Body

A radiating object whose emissivity is in constant ratio (not unity) at all wavelengths to that of a blackbody at the same temperature, and does not transmit infrared energy.

HAL

High Alarm. Units with this feature can sound an alarm when they sense that a user-defined high temperature has been reached.

Hertz (Hz)

Units in which frequency is expressed. Synonymous with cycles per second.

IEC

International Electrotechnical Commission; a European organization that coordinates and sets standards among the European Community.

IEEE-488

A communications format standard. See digital data bus.

Infrared (IR)

The portion of the electromagnetic spectrum extending from the far red visible at approximately 0.75 μm , out to 1000 μm . However, because of instrument design considerations and the atmospheric windows, most infrared measurements are made between 0.75 μm and 20 μm .

Infrared Thermometer

An instrument that converts incoming IR radiation from a spot on a target surface to a measurement value that can be related to the temperature of that spot.

Insulation Resistance

The electrical resistance of the insulating material as measured by the ratio of the applied voltage (applied for example between a conducting wire and the case or chassis ground) to the leakage current, and normally expressed in megohms.

Intrinsically Safe

A standard for preventing explosions in hazardous areas by limiting the electrical energy available to levels that are insufficient to cause ignition of explosive atmospheres during normal operation.

J,K t/c

Thermocouple types available, depending upon the temperature range to be measured.

JIS

Japanese Industrial Standard; sets standards for determining or establishing the accuracy of an IR thermometer.

K (Kelvin)

The unit of absolute or thermodynamic temperature scale where 0 K is absolute zero and 273.15 K is equal to 0° C. There is no (°) symbol used with the Kelvin scale, and $K = ^\circ\text{C} + 273.15$.

LAL

Low Alarm. Units with this feature can sound an alarm when they sense that a user-defined low temperature has been reached.

Laser

Single or dual lasers are used in some units for aiming and/or locating the optimum temperature measurement point.

LOC

Location. Units with the datalogging feature store data in numbered locations, which can be recalled and reviewed on the display when necessary.

LOCK

Locks or unlocks the trigger on portable instruments.

LOG

Datalogging. Units with the datalogging feature can store data when in the LOG mode.

Loop

A cycle of operations within a selected mode. For example, the RUN Loop cycles through standard running operations; the LOG Loop cycles through datalogging operations; and the RECALL Loop cycles through stored operations and displays the data.

mA

Milli-ampere, or 0.001 amp.

MAX

Maximum. When this mode is activated, the maximum temperature of the last series of measured temperatures displays.

Micron (or μm)

10^{-6} meters (m), or 0.000001 m.

MIN

Minimum. When this mode is activated, the minimum temperature of the last series of measured temperatures displays.

Minimum spot size

The smallest spot an instrument can accurately measure.

Mode

Modes are various user-selectable operations within Loops.

mV

Milli-volts, or 0.001 volt.

NET

Noise Equivalent Temperature. Peak to peak system electrical noise normally measured at the output (display or analog) expressed in °F or °C.

Neutral Density Filter

An optical element used to restrict the amount of energy reaching an instrument's detector by ideally attenuating the energy at all wavelengths by the same amount.

NIST Traceability

Calibration in accordance with and against standards traceable to NIST (National Institute of Standards and Technology, USA). Traceability to NIST is a means of ensuring that reference standards remain valid and their calibration remains current.

Non-Gray Body

A radiating object that is partly transparent to infrared (transmits infrared energy at certain wavelengths); also called Colored Bodies. Glass and plastic films are examples of non-gray bodies.

Optical Pyrometer

A system that, by comparing a source whose temperature is to be measured to a standardized source of illumination (usually compared to the human eye), determines the temperature of the former source.

Optical Resolution

The distance to size ratio (D:S) of the IR measurement spot, where the distance is usually defined at the focus distance, and the size is defined by the diameter of the IR energy spot at the focus (typically at the 90% IR energy spot diameter). Optical resolution may also be specified for the far field by using values of far field distance and spot size.

Pyroelectric Detector

Infrared detector which behaves as a current source with an output proportional to the rate of change of the incident IR energy.

°R (Rankine)

Temperature scale where $^{\circ}\text{R} = 1.8 \times \text{K}$, or also $^{\circ}\text{R} = ^{\circ}\text{F} + 460$.

Radiation Thermometer

A device that calculates an object's temperature (given a known emissivity) from measurement of either visible or infrared radiation from that object.

Recall (RCL)

When the Recall loop is activated, stored values can be recalled from either the RUN or LOG loops.

Reference Junction

Refers to the "cold" or ambient thermocouple junction, which is held at a known temperature. Also see thermocouple.

Reflectance

The ratio of the radiant energy reflected off a surface to that incident on the surface; for a gray body this is equal to unity minus emittance; for a perfect mirror this approaches unity; and for a blackbody the reflectance is zero.

Reflected Energy Compensation

Correction feature used to achieve greater accuracy when, due to a high uniform background temperature, IR energy is reflected off the target into the instrument. If the background temperature is known the instrument reading can be corrected by using this feature.

Relative Humidity

The ratio, expressed as a percent, of the amount of water vapor actually present in a sample of air to the greatest amount of water vapor possible at the same temperature.

Repeatability

The degree to which a single instrument gives the same reading on the same object over successive measures under the same ambient and target conditions (per the ASTM standard test method E 1256-88).

Resolution

See Temperature Resolution or Optical Resolution.

Response Time

A measure of an instrument's change of output corresponding to an instantaneous change in target temperature, generally expressed in milli-seconds, for 95 percent of full scale temperature indication (per the ASTM standard test method E 1256-88). The specification for Raytek instruments also includes the average time required for software computations.

RS-232 (1-way)

A 1-way transfer of digital information from a digital output. RS-232 is a standardized format for asynchronous serial data transfer.

RTD

Resistance Temperature Device. A contact measurement device whose resistance varies with temperature.

RUN

The RUN Loop is used when standard spot measurements need to be taken.

Scatter

See Size of Source Effect.

Setpoint

Temperature setting which when crossed by the actual temperature value will trigger an event and/or cause a relay to change state.

Setup (SET)

When in the Setup Loop, you can set values (emissivity, alarms, etc.) in either the RUN or LOG Loops.

Shock Test

An impact test per MIL-STD-810D where a force is applied to any axis of an object over a specified duration. The force is usually measured in g's ($1g = 9.81m/s^2 = 32.2 ft./s^2$), and the duration is usually measured in msec.

Silicon (Si) Detector

A photodiode detector typically used in high temperature IR thermometers.

Size of Source Effect

An undesirable increase in temperature reading caused by IR energy outside the spot reaching the detector. The effect is most pronounced when the target is much larger than the field of view.

Sleep

Units with this feature go to "sleep" either immediately or after a period of inactivity (depending on the Loop). Sleep is a period of low power consumption, no display, no laser, and no backlight.

Spectral Filter

An optical element used to restrict the spectral band of energy reaching an instrument's detector.

Spectral Response

The wavelength region in which the IR Thermometer is sensitive.

Spot

The diameter of the area on the target where the temperature determination is made. The spot is defined by the circular aperture at the target which allows typically 90% of the IR energy to be collected by the instrument, as compared with the 100% spot diameter which is defined by the IR energy collected from a very large target. The actual size and distance to the target for the 100% spot diameter is specified in the calibration procedure for each instrument.

Stare

A saturation effect caused by aiming a sensor at a "hot" target for an extended period of time and then quickly aiming at a target at a "lower" temperature. The increase in time (beyond the normal system response) for the sensor to return to within 5 % of the lower temperature is defined as the "stare" time.

Storage Temperature Range

Ambient temperature range that the thermometer can safely withstand in a non-operating mode, and subsequently, operate within published performance specifications.

TAM

T-ambient (Ambient temperature compensation). Targets that have low emissivities will reflect energy from nearby objects, which may result in inaccurate readings. Sometimes objects near the target (machines, furnaces, or other heat sources) have a temperature much higher than that of the target. In these situations it is necessary to compensate for the reflected energy from those objects. (TAM has no effect if the emissivity is 1.0.)

Target

The object upon which the temperature determination is intended to be made.

Temperature

A degree of hotness or coldness of an object measurable by a specific scale; where heat is defined as thermal energy in transit, and flows from objects of higher temperature to objects of lower temperature.

Temperature Coefficient (or Ambient Derating)

An indication of the instruments ability to maintain accuracy when the ambient conditions are subject to a slow change or drift. The temperature coefficient is usually expressed as the percent change in accuracy per degree change in ambient temperature. For a rapid change in ambient conditions refer to Thermal Shock.

Temperature Resolution

The minimum simulated or actual change in target temperature that gives a usable change in output and/or indication (per the ASTM standard test method E 1256-88).

Thermal Shock

A short term error in accuracy caused by a transient ambient temperature change. The instrument recovers from its accuracy error when it comes back into equilibrium with the new ambient conditions.

Thermistor

A semiconductor material whose resistivity changes with temperature.

Thermocouple

A junction, comprising two dissimilar metals, that develops a small voltage dependent upon the temperature of the junction. Typical thermocouples types include:

- J iron/constantan
- K chromel/alumel
- T copper/constantan
- E chromel/constantan
- R platinum/platinum-30% rhodium
- S platinum/platinum-10% rhodium
- B platinum-6% rhodium/platinum-30% rhodium
- G tungsten/tungsten-26% rhenium
- C tungsten-5% rhenium/tungsten-26% rhenium
- D tungsten-3% rhenium/tungsten-25% rhenium

Thermopile

An arrangement of thermocouples in series such that the alternate junctions are at the measuring temperature and at the reference temperature. This arrangement increases the thermoelectric voltage.

Time Constant

The time it takes for a sensing element to respond to 63.2% of a step change at the target.

Transfer Standard

A precision radiometric measurement instrument with NIST traceable calibration in the USA (with other recognized standards available for international customers), used to calibrate radiation reference sources.

Transmittance

The ratio of IR radiant energy transmitted through an object to the total IR energy received by the object for any given spectral range; the sum of emittance, reflectance, and transmittance is unity.

Warm-Up Time

Time, after turn on, until the instrument will function within specified repeatability (per the ASTM standard test method E 1256-88).

Verification

Confirmation of accuracy.

Vibration Test

An oscillatory or repetitive motion test of the instrument per MIL-STD-810D or IEC 68-2-6, often specified as an acceleration in g's ($1g = 9.81m/s^2 = 32.2 ft./s^2$), over a frequency range typically measured in Hertz (sec^{-1}).