

PSC-75 Series



Input: 85-264VAC 47/63Hz
 Output Voltage: 12, 24 & 48 V DC
 Rated Power: 75W max.

Ultra Compact

- Ultra Slim size
- Conformal coated PCB
- Parallel option available
- Universal input
- Three-year Warranty



FEATURES

- Universal AC input range(85~264Vac)
- Support 1+1 or N+1 redundant system (suggest to use redundancy modules.)
- Built-in active PFC,PF>0.95
- High efficiency up to 91%
- Built-in current sharing function
- Built-in current limiting circuit
- Output protections: OVP/OLP/SCP/OTP
- Wide operating ambient temp (-25°~70°)
- 150% peak load capacity
- Easy Fuse Tripping due to High Overload Current
- Excellent Partial Load Efficiency
- Built-in DC OK relay contact
- Can be installed on 35 mm DIN rail
- 100% full load burn-in test
- PCB with conformal coating
- Suitable for critical applications
- Ultra-slim,32mm width
- 3 years warranty

CATALOG NUMBER

INPUT

PSC-7512

PSC-7524

PSC-7548

Voltage Range	85Vac~264Vac, 127Vdc-360Vdc		
Frequency Range	47Hz~63Hz		
Power Factor (typical)	0.99/100Vac	0.95/230Vac	
AC Current (max.)	<0.95 A/100Vac	<0.45A/230Vac	
Inrush Current (Typical)	<30A/100Vac	<60A/230Vac	Cold start
Leakage Current	Input—output: ≤0.25mA Input—PG: ≤3.5mA		
Efficiency (Typical) @230Vac	88%	91%	91%

OUTPUT

DC Output	12V	24V	48V
Rated Current	6.3A	3.2A	1.6A
Current Range <i>Note 1</i>	0~6.3A	0~3.2A	0~1.6A
Ripple and Noise	0~70°C ≤100mV	≤120mV	≤120mV
	-25°C~0 ≤200mV	≤240mV	≤240mV
Voltage ADJ. Range	12~14V	24~28V	48~56V
Voltage Accuracy	±1.0%		
Line Regulation	±0.5%		
Load Regulation	±1.0%		
Set-up Time	<250mS@230Vac ; <500mS@100Vac		
Hold up Time	≥20mS(230Vac input, Full load)		
Temperature Coefficient	±0.03%/°C		
Overshoot	<5.0%		

ENVIRONMENTAL

Operating amb. Temp. & Hum.	-25°C~70°C; 20%~90%RH No condensing
Storage Temp. & Hum.	-40°C~85°C; 5%~95%RH No condensing

PROTECTIONS

Over voltage	15~18V	29~33V	58~65V
Over Load	Protection type: Hiccup mode, Auto recovery 110%~150% of rated current, Constant power limiting for some time(150% of rated current, last 3S) then PS stop working for 7S,after 7S,if the load ≤rated current, PS will work normally, auto recovery		
Over temperature	100±5°C, detect on heat sink of power transistor; shut down O/P, auto recovery after temperature goes down.		
Short Circuit	Long-term mode, auto recovery		

SAFETY & EMC

Note 3

Safety Standards	UL508, UL60950-1, EN62368-1
Withstand Voltage	Primary-Secondary:3.0kVac/10mA .Primary-PG:2.5kVac/10mA. Secondary-PG:0.5kVac/20mA.
Isolation Resistance	10M ohms
EMC Emission	Compliance to EN55032 Class B
Harmonic Current	Compliance to EN61000-3-2, Class A
EMC Immunity	Compliance to EN61000-4-2,3,4,5,6,11;

OTHER

MTBF (MIL-HDBK-217F)	More than 300,000Hrs (25°C, Full load)
Dimension (L*W*H)	124 x 119 x 32mm
Packing	28pcs/CTN,17.6Kg, 0.04cbm
Cooling method	Cooling by free air convection

NOTES

1. All parameters NOT specially mentioned are measured at rated input, rated load and 25°C of ambient temperature.
2. Measured at 20MHz of bandwidth by using a 12" twisted pair-wire terminated with a 0.1 uF & 10uF parallel capacitor.
3. The power supply is considered as a component which will be installed into a final equipment. The final equipment must be re-confirmed that it still meets EMC directives. For guidance on how to perform these EMC tests, please refer to "EMI testing of component power supplies"

For the latest on Altech Power Supply specifications please visit www.altechcorp.com/power.

Mechanical Specification

1.AC terminal blocks installation information

Terminal No.	Function	Wire Spec	Recommended Torque
1	L	20~10AWG	1Nm
2	N		
3	PG		

2.DC terminal blocks installation information

Terminal No.	Function	Wire Spec	Recommended Torque
4 & 5	DC OK Relay Contact	20~10AWG	1Nm
6	-V		
7	+V		

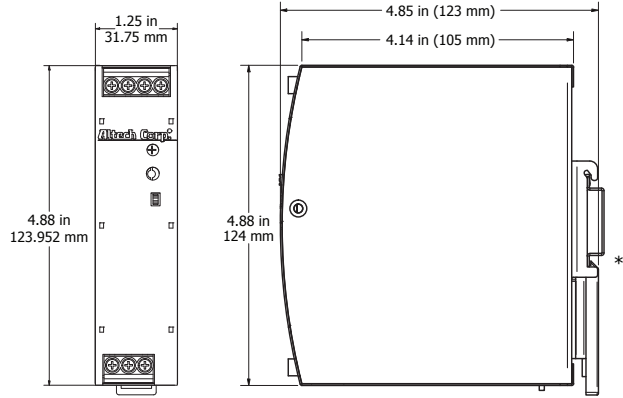

* DIN Rail sold separately.

AC/DC Terminal

Type	Screw terminal blocks
Solid Wire	0.5-6mm ²
Strand Wire	0.5-4mm ²
Wire Spec	AWG20-10 (PG wire >18AWG)
Max Wire Diameter	2.8mm
Recommended stripping length	7mm
Screwdriver	3.5mm Straight or Cross Screwdriver
Recommended Torque	1NM

Power boost	150% of rated current
DC OK	V On: when output voltage is up to 90% of rated output voltage
	V Off: when output voltage is down to 80% of rated output voltage
DC OK relay contact rating	Max 30V/1A or 60V/0.3A or 30Vac/0.3A Resistive load
Parallel function	support

Block Diagram

Functional Diagram

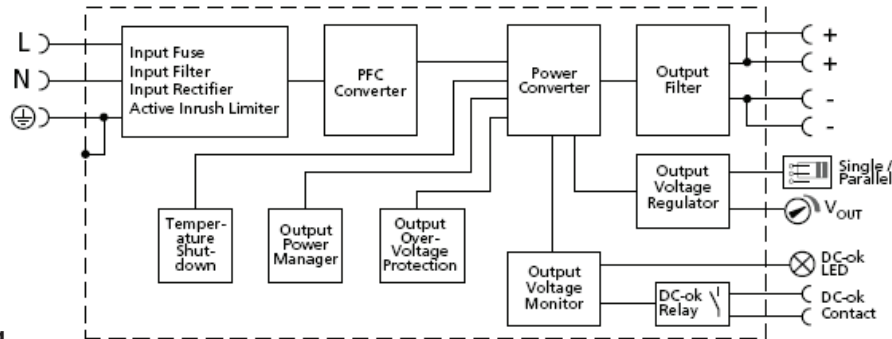

Peak Loading



Derating Curve

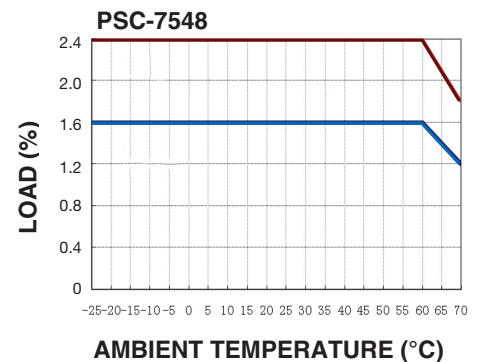
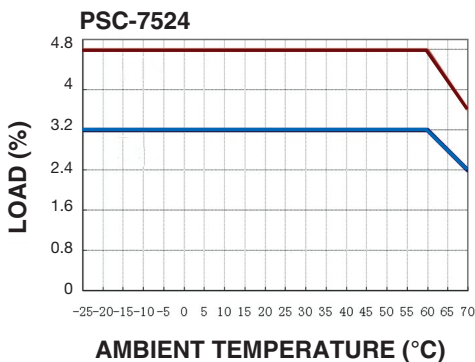
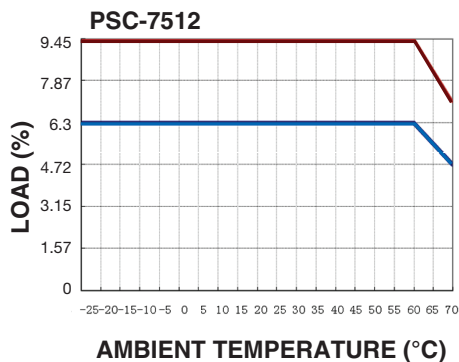

Mounting method instruction PSC-7512

A1 is recommended output current.

A2 is the allowed max output current (PSU lifetime is around half of A1).

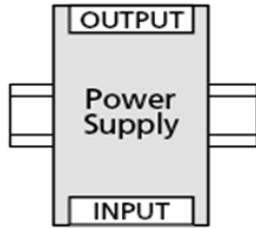

Output Current

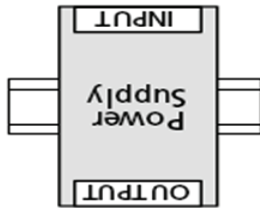
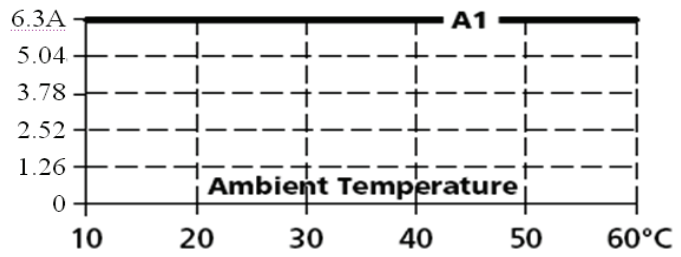

Output Current

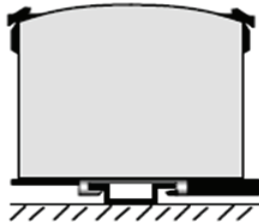
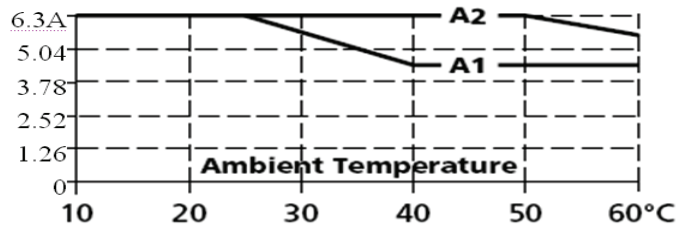

Output Current

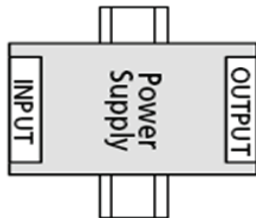
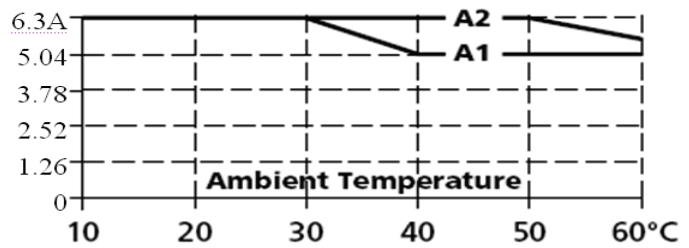

Output Current

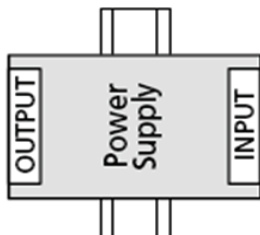
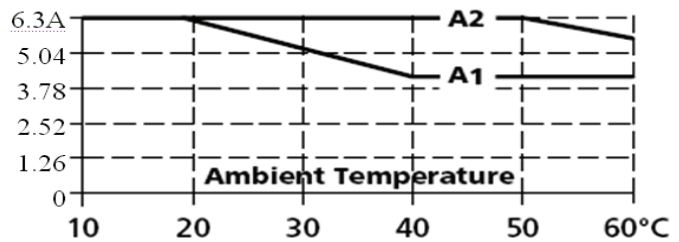

Output Current

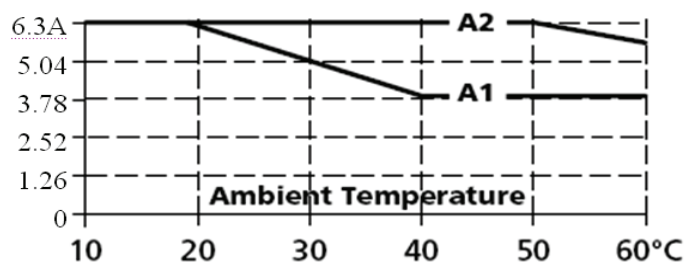

Mounting method instruction PSC-7524

A1 is recommended output current.

A2 is the allowed max output current (PSU lifetime is around half of A1).

Mounting A

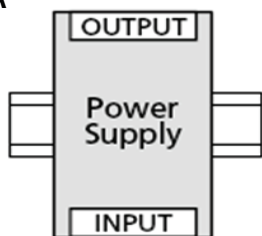

Output Current

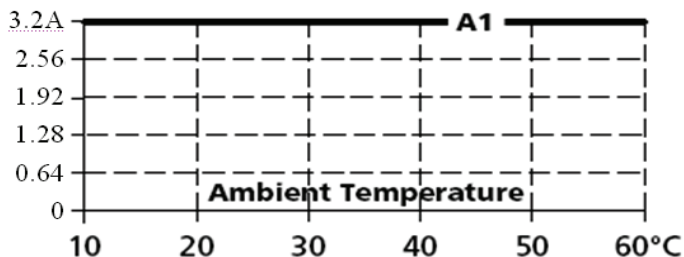

Mounting B

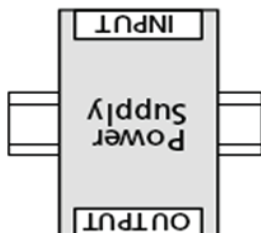

Output Current

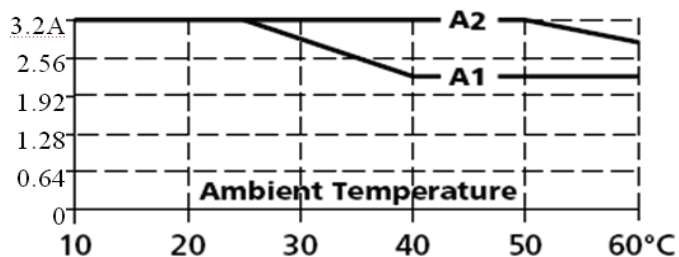

Mounting C

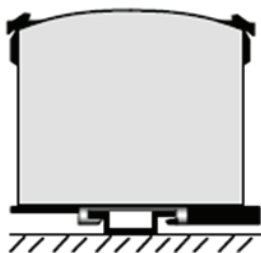

Output Current

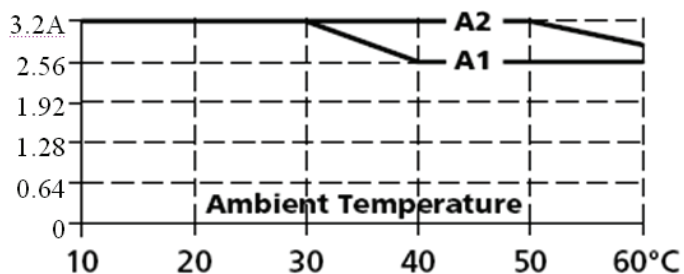

Mounting D

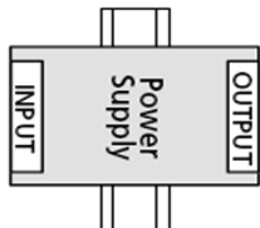

Output Current

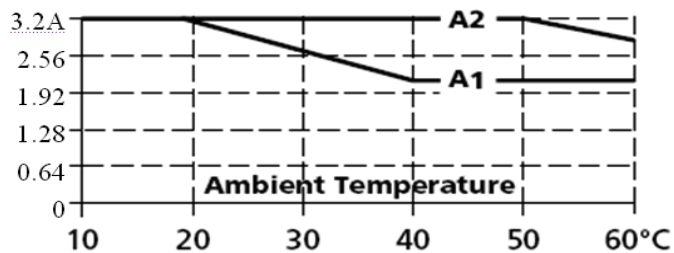

Mounting E

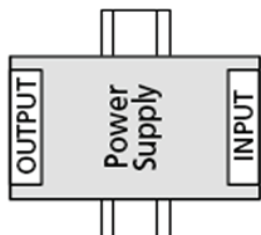

Output Current

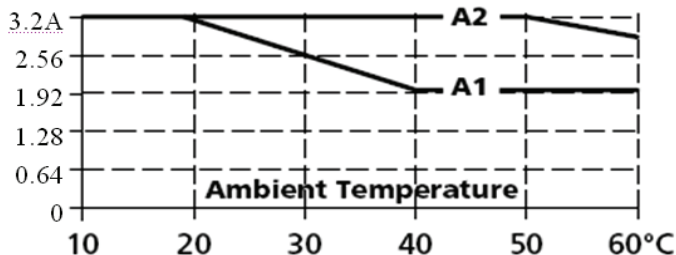

Mounting method instruction PSC-7548

A1 is recommended output current.

A2 is the allowed max output current (PSU lifetime is around half of A1).

Mounting A

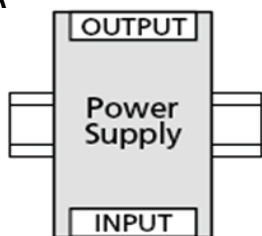

Output Current

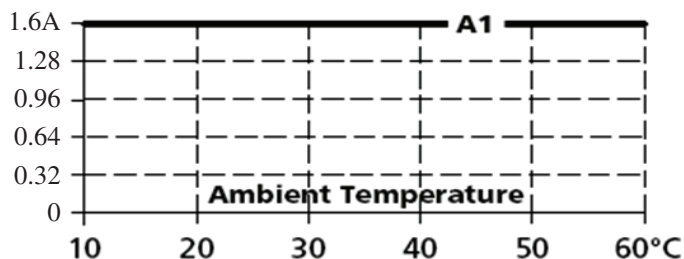

Mounting B

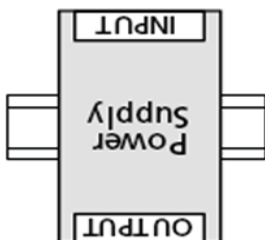

Output Current

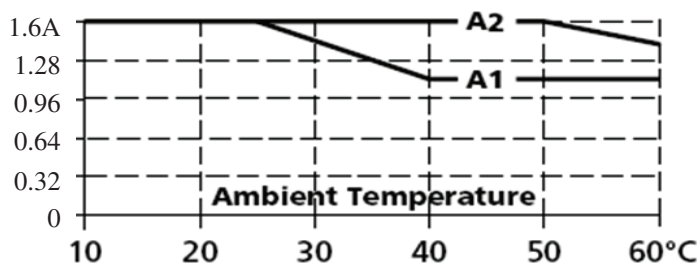

Mounting C

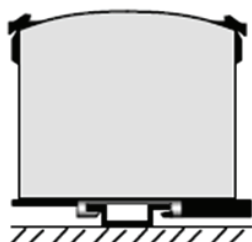

Output Current

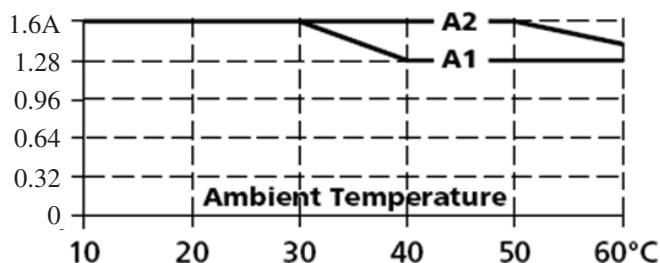

Mounting D

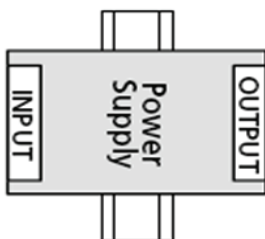

Output Current

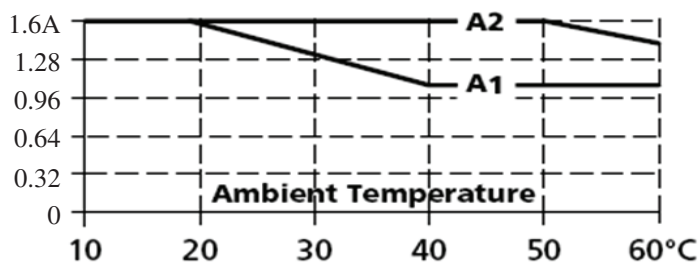

Mounting E

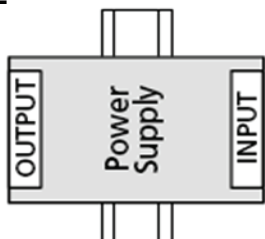

Output Current

