

UNI-T[®]

Instruments.uni-trend.com



MSO1000HD Series

High-Resolution Oscilloscopes

User Manual

The manual applies to:

MSO1000HD series

V1.0

Jan. 2025

1.800.561.8187

www.itm.com

information@itm.com



Foreword











Thank you for choosing this UNI-T instrument. For safe and proper use this instrument, please read this manual carefully, especially the safety instructions section.



After reading this manual, it is recommended to keep the manual in a convenient location, preferably near the device, for future reference.

1. Safety Instructions

This chapter contains information and warnings that must be observed. Ensure that the instrument is operated under the safe conditions. In addition to the safety precautions indicated in this chapter, you must also follow accepted safety procedures.

Safety Precautions		
Warning	Please follow these guidelines to avoid possible electric shock and risk to personal safety.	
	Users must adhere to standard safety precautions during the operation, servicing, and maintenance of this device. UNI-T will not be liable for any personal safety and property loss caused by the user's failure following the safety precautions. This device is designed for professional users and responsible organizations for measurement purposes.	
	Do not use this device in any manner not specified by the manufacturer. This device is intended for indoor use only, unless otherwise stated in the product manual. Any changes or modifications to this unit not expressly approved by the party responsible for compliance could void the user's authority to operate the equipment.	
Safety Statements		
Warning	"Warning" indicates the presence of a hazard. It warns users to pay attention to a certain operation process, operation method or similar. Personal injury or death may occur if the rules in the "Warning" statement are not properly executed or observed. Do not proceed to the next step until you fully understand and meet the conditions stated in the "Warning" statement.	
Caution	"Caution" indicates the presence of a hazard. It warns users to pay attention to a certain operation process, operation method or similar. Product damage or loss of important data may occur if the rules in the "Caution" statement are not properly executed or observed. Do not proceed to the next step until you fully understand and meet the conditions stated in the "Caution" statement.	
Note	"Note" indicates important information. It reminds users to pay attention to procedures, methods, and conditions, etc. The contents of "Note" should be highlighted if necessary.	
Safety Sign		
	Danger	It indicates danger of electric shock, which may cause personal injury or death.
	Warning	It indicates that there are factors you should be cautious of to prevent personal injury or product damage.
	Caution	It indicates danger, which may cause damage to this device or other equipment if you fail to follow a certain procedure or

		condition. If the “Caution” sign is present, all conditions must be met before you proceed to operation.
	Note	It indicates potential problems, which may cause failure of this device if you fail to follow a certain procedure or condition. If the “Note” sign is present, all conditions must be met before this device will function properly.
	AC	Alternating current of device. Please check the region's voltage range.
	DC	Direct current device. Please check the region's voltage range.
	Grounding	Frame and chassis grounding terminal
	Grounding	Protective grounding terminal
	Grounding	Measurement grounding terminal
	OFF	Main power off
	ON	Main power on
	Power	Standby power supply: When the power switch is turned off, this device is not completely disconnected from the AC power supply.
CAT I		Secondary electrical circuit connected to wall sockets through transformers or similar equipment, such as electronic instruments and electronic equipment; electronic equipment with protective measures, and any high-voltage and low-voltage circuits, such as the copier in the office.
CAT II		Primary electrical circuit of the electrical equipment connected to the indoor socket via the power cord, such as mobile tools, home appliances, etc. Household appliances, portable tools (e.g., electric drill), household sockets, sockets more than 10 meters away from CAT III circuit or sockets more than 20 meters away from CAT IV circuit.
CAT III		Primary circuit of large equipment directly connected to the distribution board and circuit between the distribution board and the socket (three-phase distributor circuit includes a single commercial lighting circuit). Fixed equipment, such as multi-phase motor and multi-phase fuse box; lighting equipment and lines inside large buildings; machine tools and power distribution boards at industrial sites (workshops).
CAT IV		Three-phase public power unit and outdoor power supply line equipment. Equipment designed to “initial connection,” such as power distribution system of power station, power instrument, front-end overload protection, and any outdoor transmission line.
	Certification	CE indicates a registered trademark of EU.
	Certification	Conforms to UL STD 61010-1 and 61010-2-030. Certified to CSA STD C22.2 No.61010-1 and 61010-2-030.

	Waste	Do not place equipment and accessories in the trash. Items must be properly disposed of in accordance with local regulations.
	EFUP	This environment-friendly use period (EFUP) mark indicates that dangerous or toxic substances will not leak or cause damage within this indicated time period. The environmentally friendly use period of this product is 40 years, during which it can be used safely. Upon expiration of this period, it should enter the recycling system.

Safety Requirements	
Warning	
Preparation before use	<p>Please connect this device to AC power supply with the power cable provided.</p> <p>The AC input voltage of the line reaches the rated value of this device. See the product manual for specific rated value.</p> <p>The line voltage switch of this device matches the line voltage.</p> <p>The line voltage of the line fuse of this device is correct.</p> <p>This device is not intended for measuring the main circuit.</p>
Check all terminal rated values	<p>Please check all rated values and marking instructions on the product to avoid fire and the impact of excessive current. Please consult the product manual for detailed rated values before connection.</p>
Use the power cord properly	<p>You can only use the special power cord for the instrument approved by the local and state standards. Please check whether the insulation layer of the cord is damaged, or the cord is exposed, and test whether the cord is conductive. If the cord is damaged, please replace it before using the instrument.</p>
Instrument Grounding	<p>To avoid electric shock, the grounding conductor must be connected to the ground. This product is grounded through the grounding conductor of the power supply. Please be sure to ground this product before it is powered on.</p>
AC power supply	<p>Please use the AC power supply specified for this device. Please use the power cord approved by your country and confirm that the insulation layer is not damaged.</p>
Electrostatic prevention	<p>This device may be damaged by static electricity, so it should be tested in the anti-static area if possible. Before the power cable is connected to this device, the internal and external conductors should be grounded briefly to release static electricity. The protection grade of this device is 4 kV for contact discharge and 8 kV for air discharge.</p>

Measurement accessories	Measurement accessories designated as lower-grade, which are not applicable to main power supply measurement, CAT II, CAT III, or CAT IV circuit measurement. Probe subassemblies and accessories within the range of IEC 61010-031 and current sensors within the range of IEC 61010-2-032 can meet its requirements.
Use the input / output port of this device properly	Please use the input / output ports provided by this device in a proper manner. Do not load any input signal at the output port of this device. Do not load any signal that does not reach the rated value at the input port of this device. The probe or other connection accessories should be effectively grounded to avoid product damage or abnormal function. Please refer to the product manual for the rated value of the input / output port of this device.
Power fuse	Please use a power fuse of exact specification. If the fuse needs to be replaced, it must be replaced with another one that meets the specified specifications by the maintenance personnel authorized by UNI-T.
Disassembly and cleaning	There are no components available for operators inside. Do not remove the protective cover. Qualified personnel must conduct maintenance.
Service environment	This device should be used indoors in a clean and dry environment with ambient temperature from 0 °C to +40 °C. Do not use this device in explosive, dusty, or high humidity conditions.
Do not operate in humid environment	Do not use this device in a humid environment to avoid the risk of internal short circuit or electric shock.
Do not operate in flammable and explosive environment	Do not use this device in a flammable and explosive environment to avoid product damage or personal injury.
Caution	
Abnormality	If this device may be faulty, please contact the authorized maintenance personnel of UNI-T for testing. Any maintenance, adjustment or parts replacement must be done by the relevant personnel of UNI-T.
Cooling	Do not block the ventilation holes at the side and back of this device. Do not allow any external objects to enter this device via ventilation holes. Please ensure adequate ventilation and leave a gap of at least 15 cm on both sides, front and back of this device.

Safe transportation	Please transport this device safely to prevent it from sliding, which may damage the buttons, knobs, or interfaces on the instrument panel.
Proper ventilation	Insufficient ventilation will cause the device temperature to rise, thus causing damage to this device. Please keep proper ventilation during use, and regularly check the vents and fans.
Keep clean and dry	Please take actions to avoid dust or moisture in the air affecting the performance of this device. Please keep the product surface clean and dry.
Note	
Calibration	The recommended calibration period is one year. Calibration should only be conducted by qualified personnel.

1.1. Environmental Requirements

This instrument is suitable for the following environment.

- Indoor use
- Pollution degree: Class 2
- Overvoltage category: This product should be powered from a mains supply that complies with Overvoltage Category II, which is a typical requirement for connecting equipment via power cords and plugs.
- Operating: Altitude below 3,000 meters; non-operating: Altitude below 15,000 meters.
- Unless otherwise specified, the operating temperature range is from 0 °C to +40 °C, and the storage temperature range is from -20 °C to +60 °C.
- Operating: Humidity at temperature below +35 °C, ≤ 90% RH. (Relative humidity);
non-operating: Humidity at temperatures from +35 °C to +40 °C, ≤ 60% RH.

There are ventilation outlets on the rear and side panels of the instrument, please keep the air ventilation in the outlet of housing. To prevent excessive dust from blocking the vents, clean the instrument housing regularly. The housing is not waterproof; please cut off the power supply first and then wipe the housing with a dry cloth or a slightly moistened soft cloth.

1.2. Connecting Power Supply

The specification of the AC power supply is as shown in the following table.

Voltage Range	Frequency
100-240 VAC (Fluctuations ±10%)	50/60 Hz

Please use the attached power cord to connect to the power port.

Connecting to the service cable:

This instrument is a Class I safety product. The supplied power cables have reliable performance in terms of case grounding. This instrument is equipped with a three-prong power cable that meets international safety standards. It provides good case grounding performance for the specifications of your country or region.

Please install the AC power cable as follows:

- Ensure the power cable is in good condition.
- Leave enough space to connect the power cord.
- Plug the attached three-prong power cable into a well-grounded power socket.

1.3. Electrostatic Protection

Electrostatic discharge may cause damage to components. Components can be invisibly damaged by electrostatic discharge during transportation, storage, and use.

The following measures can reduce the damage caused by electrostatic discharge:

- Test in an antistatic area as far as possible.
- Before connecting the power cable to the instrument, briefly ground the inner and outer conductors of the instrument to discharge static electricity.
- Ensure all instruments are properly grounded to prevent the accumulation of static.

2. Introduction

This manual introduces the safety requirements, installation, and operation of the MSO1000HD series high-resolution oscilloscopes.

3. MSO1000HD Series Oscilloscopes

MSO1000HD series high-resolution oscilloscopes includes the following models.

Model	Analog channel number	Analog bandwidth	Digital	Gen
MSO1154HD	4	150 MHz	●	×
MSO1154HD-S	4	150 MHz	●	●
MSO1254HD	4	250MHz	●	×
MSO1254HD-S	4	250MHz	●	●

○: Option ●: Standard ×: Not support

MSO1000HD series high-resolution oscilloscopes is a versatile, high-performance instrument based on UNI-T's original Ultra Phosphor technology. It offers an ideal combination of ease of use, excellent technical specifications, and a range of functional features to help users complete their testing more efficiently. Designed for general-purpose design, debugging, and testing, it serves a broad spectrum of digital oscilloscope markets, including communications, semiconductors, computers, instrumentation, industrial electronics, consumer electronics, automotive electronics, field maintenance, R&D/education, and more.

4. Document Overview

This user manual is designed to help users quickly understand the front panel, rear panel, user interface, and basic operations of the MSO1000HD series high-resolution oscilloscopes.

Note: The latest edition of the user manual can be downloaded from the UNI-T website:

<https://www.uni-trend.com>

(1) Software Version

The software update may change or add new functions. Please visit the UNI-T website for the latest version or contact UNI-T to upgrade the software.

(2) Document Format

a. Key

A key with a character frame represents a key on the front panel. For example, Default represents the “Default” key.

b. Menu

Double quotation marks represent a menu or a pop-up menu. For example, “Channel Setting” pop-up menu on the operation interface allows you to click on “Vertical Scale” to operate and set the vertical scale settings.

c. Operation Step

Use an arrow “>” represent the next step. For example, “Storage > Save” represents that in the Storage Menu, you should first click on “Storage” and then click on “Save” to save the waveform, setting, or picture file.

d. Connector

“Square brackets + Word” represents a connector on the front or rear panel. For example, [AUX OUT].

e. Hyperlink

“Underline + Blue text” represents a hyperlink. For example, [Connecting Power Supply](#).

f. Rotary knob

A key with an underline represents a rotary knob. For example, Position represents the vertical rotary knob.

5. Getting Started Guide

- [General Inspection](#)
- [Before Use](#)
- [Front Panel](#)
- [Rear Panel](#)
- [Operation Panel](#)
- [User Interface](#)
- [Touch Screen](#)
- [Parameter Setting](#)
- [Remote Control](#)

This chapter is to introduce on using the oscilloscope for the first time, the front and rear panels, the user interface, as well as touch screen function.

5.1. General Inspection

It is recommended to inspect the instrument follow the steps below before using the MSO1000HD series oscilloscopes for the first time.

- (1) Check for Damages caused by Transport

If the packaging carton or the foam plastic cushions are severely damaged, please contact the UNI-T distributor of this product immediately.

- (2) Check Accessories

The details of the supplied accessories are described in the MSO1000HD Series high-resolution Oscilloscopes accessories section in this manual. Please refer to this section for the list of accessories. If any accessories are missing or damaged, contact UNI-T or the local distributors of this product.

- (3) Machine Inspection

If the instrument appears to be damaged, not working properly, or has failed the functionality test, please contact UNI-T or local distributors of this product.

If the equipment is damaged due to shipping, please keep the packaging and notify both the

transportation department and UNI-T distributors, UNI-T will arrange maintenance or replacement.

5.2. Before Use

To perform a quick verification of the instrument's normal operations, please follow the steps below.

(1) To Adjust the Supporting Legs

Adjust the supporting legs properly to use them as stands to tilt the oscilloscope upwards for stable placement of the oscilloscope as well as better operation and observation. You can also fold the supporting legs when the instrument is not in use for easier storage or shipment



(2) To Connect To Power

The power requirements of the oscilloscope are DC, at least 12 V/3 A. Please use the power adaptor provided in the accessories to connect the oscilloscope to the AC power source (100 V - 240 V, 50 Hz - 60 Hz) .



Power Adaptor Specifications

Item	Description
Input	100V - 240 V, 50 Hz - 60 Hz, 1.6 A Max
output	DC, 12 V, 3 A, 65 W

(3) Boot Check

Press the soft power switch key and the indicator  should change from red to green. The oscilloscope will show a boot animation, and then enter the normal interface.

(4) Connecting Probe

This oscilloscope provides 1 pieces of compensating signal probe. Connect the BNC of the probe to the BNC of oscilloscope's CH1 and connect the probe to the "probe compensating signal connection clip", and then connect the ground alligator clip of the probe with the ground terminal of compensating signal connection clip. The output of compensating signal connection clip: amplitude is approximately 3 Vpp, with a default frequency of 1 kHz.

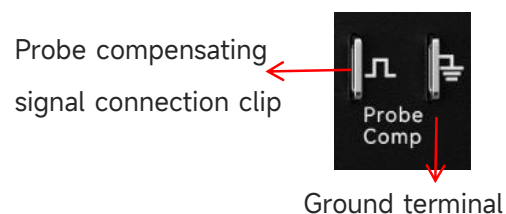

Probe Compensating Signal Connection Clip and Ground Terminal

(5) Function Check

Press the Autoset key, a square wave (amplitude 3 Vpp, frequency 1 kHz) should appear on the

screen. Repeat step 3 to check all channels.

(6) Probe Compensation

When the probe is connected to any input channel for the first time, this step might be adjusted to match the probe and the input channel. Probes that are not compensated may lead to measurement errors or mistakes. Please follow the following steps to adjust the probe compensation.

- Set the attenuation ratio in the probe menu to 10x and set the probe switch to 10x. Connect the oscilloscope probe to CH1. If using the probe's hook tip, ensure it makes stable contact. Connecting the probe to the "Probe Compensation Signal Connection Clip" of the oscilloscope and connect the ground alligator clip to the ground terminal of probe compensating signal connection clip. Open CH1 and press the **Autoset** key.
- View the displayed waveform, as shown in the following figure.



Excessive Compensation Correct Compensation Insufficient Compensation
Probe Compensation Calibration

- If the displayed waveform resembles the above "Insufficient Compensation" or "Excessive Compensation", use a non-metallic screwdriver to adjust the probe's variable capacitance until the display matches the "Correct compensation" waveform.

Warning: To avoid electric shock when using the probe to measure high voltage, please ensure that the probe insulation is in good condition and avoid physical contact with any metallic part of the probe.

5.3. Front Panel



Front Panel

No.	Description	No.	Description
1	Display area	8	Probe compensating signal connection clip and ground terminal ①
2	Measurement analysis area	9	Vertical control area
3	Multi-function area	10	Analog channel input terminal ②
4	Control area	11	Digital channel input terminal ③
5	Horizontal control area	12	USB HOST port
6	Trigger control area (Vertical)	13	Power soft switch key
7	Shortcut keys and search navigation		

① Probe compensation signal connection terminal and ground terminal: Connect the BNC end of the probe to the BNC connector on Channel 1 of the oscilloscope. Attach the probe tip to the "Probe Compensation Signal Terminal," and connect the probe's ground alligator clip to the "Ground Terminal" beneath the probe compensation signal terminal. This setup will output the oscilloscope's internal signal. For more details, refer to the section [Before Use - Connecting the Probe.](#)

- ② Analog channel input terminal: Connect the oscilloscope probe or BNC cable to these BNC connectors to input a signal into the oscilloscope.
- ③ Digital channel input port: Use the UT-M26 logic probe, provided as an accessory, to connect the oscilloscope to the device under test for digital channel usage. For more details, refer to the section [Digital Channel](#).

5.4. Rear Panel

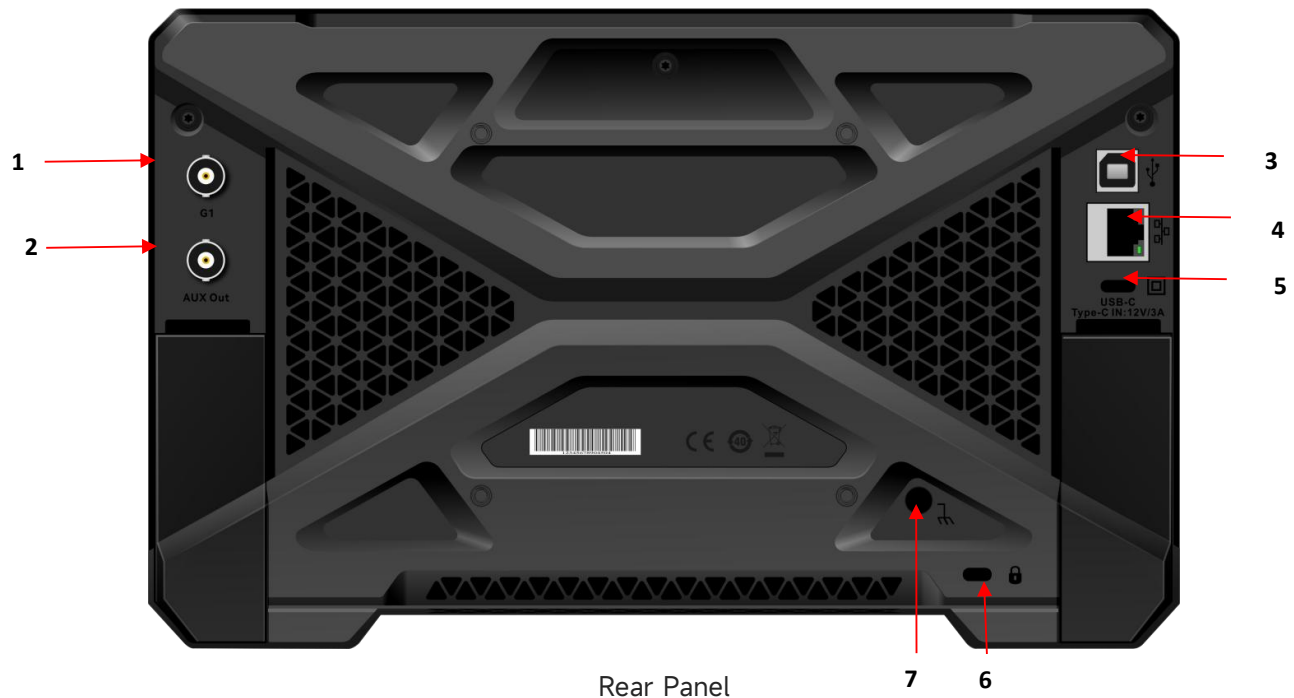

1. G1 signal source output terminal, can output sine wave, square wave, oblique wave, arbitrary wave, modulated wave, sweep signal, For more details, refer to the section [Function/Arbitrary Waveform Generator \(Gen\)](#).
2. AUX OUT: Output terminal for trigger output, Pass/Fail output, DVM output.
3. USB Device: USB Device for communication between the oscilloscope and a PC.
4. LAN: Connects to LAN for remote control.
5. USB Type-C Power Connector: The power supply specifications for this instrument are DC 12 V, 3.5 A. Please use the power adapter provided in the accessories to connect the instrument to the AC power supply, as described in the "Connecting the Power Supply" section.
6. Safety lock: Lock the oscilloscope at fixed position (sold separately).
7. Ground terminal: Connects to the ground using a cable.

5.5. Operation Panel

(1) Vertical Control



- **1**, **2**, **3**, **4**: Analog channel setting key respectively represents CH1, CH2, CH3 and CH4. Four channel's tabs are identified by different colors and they also correspond to the colors of waveforms on the screen and the channel input connectors. Press any keys to enter the related channel menu (activate or disable the channel). For more details, refer to the section of [Vertical System](#).

- **Math**: Press this key to open the mathematical operation menu to perform math operation (add, subtract, multiply, divide), digital filter and advanced operation. For more details, refer to the section of [Mathematical Operation](#).
- **Ref**: Loading the reference waveform from "local or USB", so the measured waveform can compare with the reference waveform. For more details, refer to the section of Reference Waveform.
- **Digital**: Press this key to enter Digital setting, to set basics, grouping, threshold, bus and label. For more details, refer to the section of [Digital Channel](#).
- **Scale**: Vertical scale rotary knob is used to adjust the vertical scale in the current channel. Turn clockwise to decrease the scale, turn counterclockwise to increase the scale. The amplitude of waveform will increase or decrease with the adjustment and the scale at the



bottom of screen will change in real-time.

The vertical scale is step with 1-2-5, press this rotary knob to adjust the vertical scale between coarse tuning and fine tuning.

- **Position**: Vertical position rotary knob is used to move the vertical position of the waveform in the current channel. Press this rotary knob to move the channel position back to the vertical midpoint.

(2) Horizontal Control



- **Menu**: Horizontal menu key is used to display the horizontal scale, time base mode (XY/YT), horizontal, auto roll, quick roll time base, horizontal position, time base extension and time base selection. For more details, refer to the section of

[Horizontal System](#) for more details.

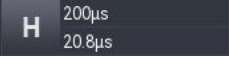
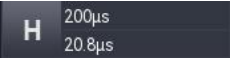
- **Scale:** Horizontal scale rotary knob is used to adjust all channel time base. During the adjustment, the waveform is compressed or extended in horizontal show on the screen and the horizontal scale value  will change in real-time. The time base is step with 1-2-5, press this rotary knob to adjust the horizontal scale between coarse tuning and fine tuning.
- **Position:** Horizontal position rotary knob is used to move the trigger point to left or right side that relative to the center of the screen. During the adjustment, all channel waveforms move to left or right side and the horizontal shift value on the top of the screen  will change in real-time. Press this rotary knob to move the current position back to the horizontal midpoint.

(3) Trigger Control

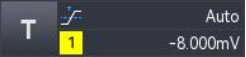

- **Slope:** Press the Slope key to switch the trigger edge: rising edge, falling edge, or any edge, The corresponding edge's indicator light will illuminate when switching the edge.
- **Menu:** Press the Menu key to enter the trigger menu. For more details, refer to the section of [Triggering System](#).
- **Source:** Press the Source key to switch the trigger source. The panel numbers 1 to 4 correspond to channels C1 to C4. When switching the source, the corresponding number's indicator light will illuminate.
- **Position:** Trigger level rotary knob, turn clockwise to increase the level, turn counterclockwise to decrease the level. During the adjustment, the trigger level  in the top right will change in real-time. When the trigger is single level, press this rotary knob to turn the trigger level to the trigger signal and quickly turn to 50%.
- When the trigger status is READY or TRIGED, the corresponding Ready or Trig'd indicator light in the trigger control area will illuminate.

(4) Control Area



- **Auto/Normal:** Press the Auto/Normal key to switch the oscilloscope trigger mode between Auto and Normal.
- **Run/Stop:** This key is used to set the operating mode of the oscilloscope to "Run" or "Stop". In the "RUN" state, the key is illuminated in green.

In the “STOP” state, the key is illuminated in red.

- **Force**: When the trigger mode is Normal or Single, press the force trigger key to generate a trigger.
- **Autoset**: After pressing the Autoset key, the oscilloscope automatically adjusts the vertical scale, time base, and trigger mode based on the input signal to display the optimal waveform.
- **Single**: Press the Single key to set the oscilloscope's trigger mode to “Single”; the key will illuminate in orange.

(5) Measurement Analysis Area

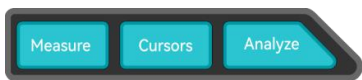

- **Measure**: Press the Measure key to enter the measurement menu, to set the counter, voltmeter, parameter snapshot, measurement statistics, add measurement, clear measurement, and global settings. For more details, refer to the section [Automatic Measurement](#).
- **Cursor**: Press the Cursor key to enter the cursor measurement menu, to set time, voltage, and screen measurement for each source. For more details, refer to the section of [Cursor Measurement](#).
- **Analyze**: Press the Analyze to open the analysis module menu, where the user can access functions such as the voltmeter, counter, power analysis, waveform recording, and pass/fail test.

(6) Multipurpose area



- **Multipurpose A**: Multi-function knob A. When a numerical menu is selected in the function popup window, the LED on the multi-function knob will light up, allowing the user to adjust values using the knob.
- **Multipurpose B**: Multi-function knob B. When setting numerical parameters in a text box, the user can rotate this knob to shift the selected digit.

(7) Shortcut key area



- **Quick**: Press the Quick key to quickly save the screen waveform as a PNG bitmap to the default or a custom image path.
- **Clear**: Press the Clear key to clear all recalled waveforms and parameter measurement statistics from the screen.
- **Touch/Lock**: Press the Touch/Lock key to disable the touchscreen function; the background light will illuminate. To enable the touchscreen again, press this key once more,

and the background light will turn off.

- **Default:** Restore factory settings. Press the Default key to reset all oscilloscope settings to their default values.

(8) Signal Output Area



- **Gen:** Press the Gen key to open the signal source Gen settings menu. For more details, refer to the section [Function/Arbitrary Waveform Generator \(Gen\)](#).

(9) Home Menu



Press the Home icon in the top right corner to open “Home” quick menu, including the quick menu: voltmeter, FFT, signal source, Math, reference, help, cursor, Bode diagram, storage, counter, measurement, regional drawing, display, auxiliary, decoding, search, regional diagram, navigation, waveform recording, power analysis, and Pass/Fail. Press the quick menu to enter the corresponding function module.

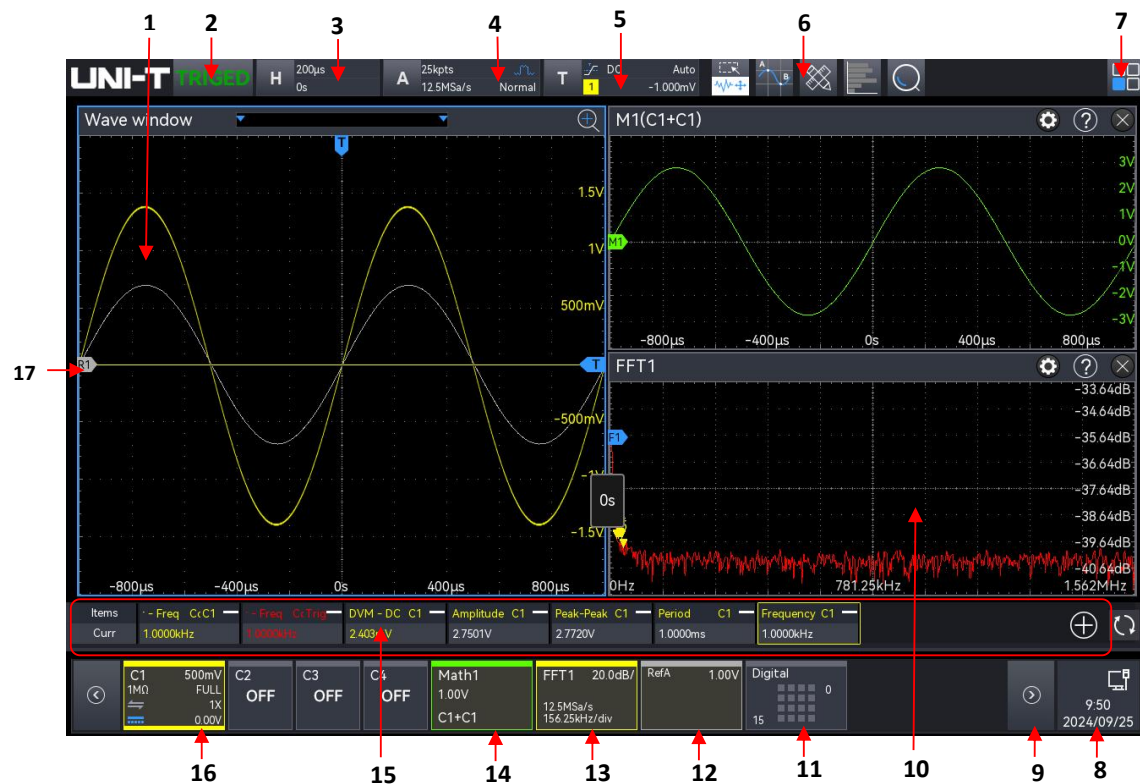

5.6. User Interface



1. Display: C1-C4 waveform measurement window, Ref waveform, and Math waveform.
2. Trigger state icon: TRIGED, AUTO, READY, STOP, ROLL, and SCAN.
3. Horizontal base label: Displays the current horizontal time base, click to enter the horizontal setting menu.
4. Sampling rate and memory depth label: Displays the current sampling rate and memory depth, click to enter the horizontal setting menu.
5. Trigger info label: Displays the trigger information, including the trigger type, source, level, and mode. Click the label to open the 'Trigger Setting' window and adjust the trigger parameters.
6. Function toolbar: Displays the currently added functions in toolbar. Touch an icon to enter the corresponding function menu. A maximum of 9 icons can be displayed.
7. Home menu: Open the function guide menu, click each function key to enter the corresponding menu.
8. Notification: Displays the USB, LAN connection icon, and time. Click this area to open the setting menu. Refer to the Notification section for more details.
 - USB: When the instrument detects a USB is connected, a USB icon is displayed in this area.
 - LAN : When the LAN is successfully connected, the LAN icons is displayed in this area;
 - Time: Displays the current time and allows you to set the system time.

9. Volts/div signal bar: When the volts/div has multiple info box at the bottom of the screen, press this key ,  to move to left or right and reveal the hidden box.
10. Multi-window display area: If multiple functions are enabled simultaneously, such as XY, Math, and FFT, multiple function windows can be displayed at the same time.
11. Digital channel label: Displays the status of the digital channel switch. Open channels are highlighted. Click to access the digital settings menu.
12. Ref label: Displays the status of Ref1-Ref4 and vertical scale switch. Up to 4 Ref labels can be displayed.
13. FFT label: Displays the status of FFT1-FFT4 switch, vertical scale, sampling rate, and the frequency of each div. Up to 4 FFT labels can be displayed.
14. Math label: Displays the status of M1-M4 switch, vertical scale, and operation type. Up to 4 Math labels can be displayed.
15. Measured result display window: Displays counter, DVM measurement, parameter measurement, and statistical results. This window can be enabled or disabled.
16. Channel label: Displays the status of C1-C4 switch, vertical scale, impedance, bandwidth limitation, inverse phase, channel coupling, probe multiplying ratio, and vertical bias.
17. Analog channel label: Displays the CH1-CH4 icons. Each channel icon matches the color of its corresponding waveform.

5.7. Touch Screen

MSO1000HD series provides 7-inch super capacitive touch screen, multiple point touch control and gesture control. MSO1000HD has an easy operating system with flexible and high-sensitive touch screen features for great waveform display and excellent user experience.

Touch control function includes tap, pinch, drag, and rectangle drawing.

Note: The menu displayed on the screen of the oscilloscope can all use the touch control function.

(1) Tap

Use one finger to slightly tap on an icon or a word on the screen as shown in the following figure.

Tap gestures can be used for:

- Tap the menu display on the screen and then to setup.
- Tap the function icon in the top right corner to open the corresponding function.
- Tap the pop-up numeric keypad to set the parameter.
- Tap the virtual keyboard to set the label name and file name.

- Tap a message to open a close button in the top right corner to close the pop-up window.
- Tap another window displayed on the screen and then to setup.
- Tap a message to open a help button in the top right corner to open the corresponding function help menu.



Tap Gesture

(2) Pinch

Squeeze two fingers together or separate. Pinch gestures can zoom out or zoom in the waveform. To zoom out the waveform, pinch two fingers together and then slide them apart; to zoom in, spread two fingers apart and then pinch them together, as shown in the following figure.

Pinch gestures can be used for:

- Adjust the horizontal time base of waveform by squeezing in the horizontal direction.
- Adjust the vertical time base of waveform by squeezing on the vertical direction.

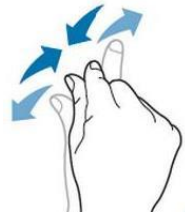

Pinch Gesture

(3) Drag

Use one finger to press and drag the selected item to the aimed position as shown in the following figure.

Drag gestures can be used for:

- Drag the waveform to change the waveform position.
- Drag the window to change the window position.
- Drag the cursor to change the cursor position.

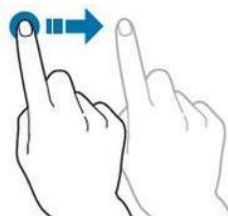

Drag Gesture

(4) Rectangle Drawing

Open the HOME menu and click the icon “Rectangle Drawing” to enable the function, drag your finger to draw a rectangle on the screen as shown in Figure (a), (b), move the finger, a menu will appear on the screen, at this point, “Zone A”, “Zone B”, “Intersection”, “Non-intersect” can be selected. Drag your finger from bottom right to the top left on the screen to draw the trigger area.

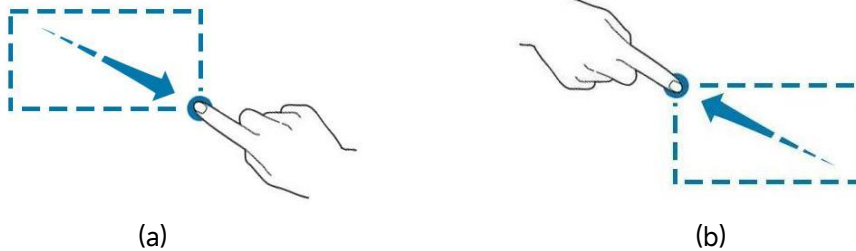



Rectangle Drawing Gesture

Select “Zone A”:

- Draw zone A
- Open zone A
- Open “Zone Trigger” menu

Select “Zone B”:

- Draw zone B
- Open zone B
- Open “Zone Trigger” menu

Note: Click on “Rectangle drawing” to step through rectangle drawing and operating waveform mode. Click on “Rectangle Drawing”, if the icon shows , it indicates that “Rectangle Drawing” mode is enabled; if the icon shows , it indicates that “Operating Waveform” mode is enabled.

5.8. Parameter Setting

MSO1000HD series supports use the Multipurpose A (Multipurpose rotary knob) and touch screen to set the parameter. The setting steps are as follows.

(1) Multipurpose Rotary Knob

For the parameter of time and voltage, once the parameter is selected, rotate the Multipurpose A knob on the front panel to enter the parameter value.

(2) Touch Screen

Once the parameter or input field has been selected, double-click to open the virtual keyboard

to enter the parameter value, label name, or file name.

a. Enter character string

When naming a file or folder, use the character keyboard to enter a string.

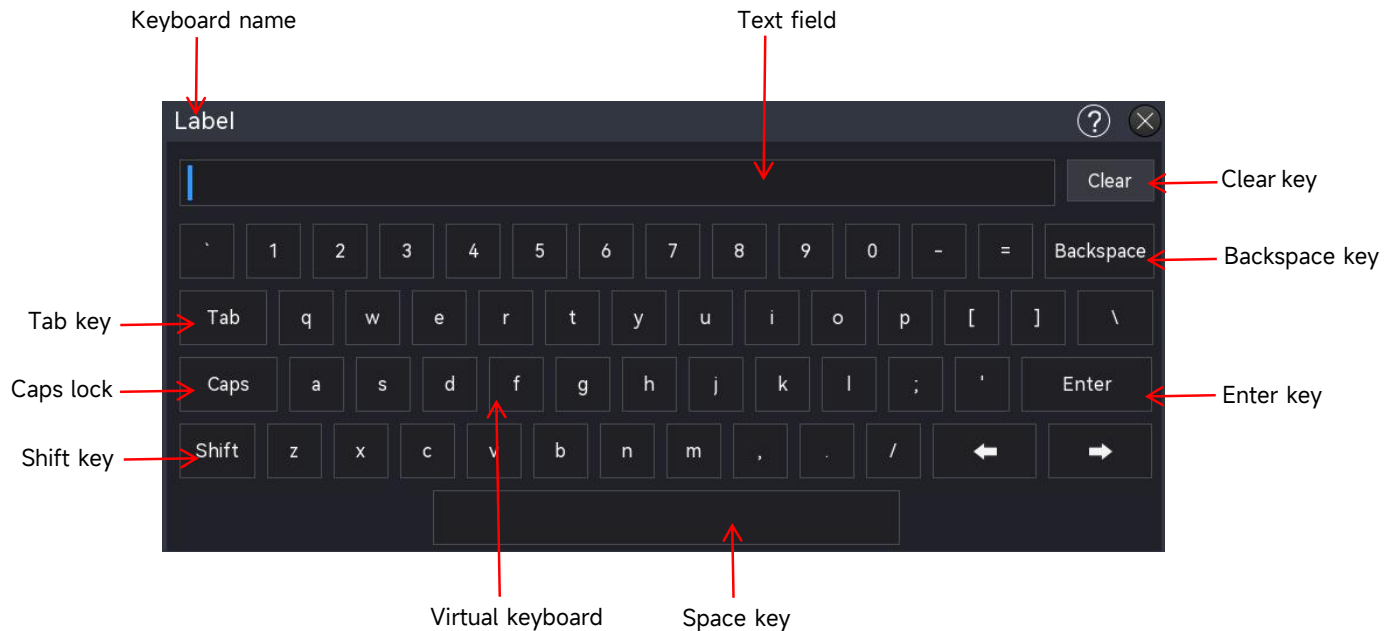

b. Input field

Enter text: input letters, numbers, and special characters, with a maximum length of 16 characters.

c. Clear key

Press the “Clear” key to delete all contents in the input field.

d. Caps key

Press the “Caps” key to switch between upper and lower case.

e. Tab key

Press the “Tab” key to enter 2 spaces at a time.

f. Shift key

Press the “Shift” key to switch among number, special character, upper and lower case.

g. Arrow keys (left, right)

If part of the content needs to be changed, press the “←”, “→” key to move the cursor to left or right and then to edit the content.

h. Space key

Press the “Space” key to enter one space in the input field.

i. Backspace key

Press the “Backspace” key to delete a single character. This key is used to delete a

character when the input field contains a large amount of content.

j. Enter key

Once the content has been entered, press the “Enter” key to confirm the setting and close the virtual keyboard.

(3) Enter Numeric Value

When setting or editing a parameter, use the numeric keypad to enter the numeric value.

1. Click the number or unit to enter.

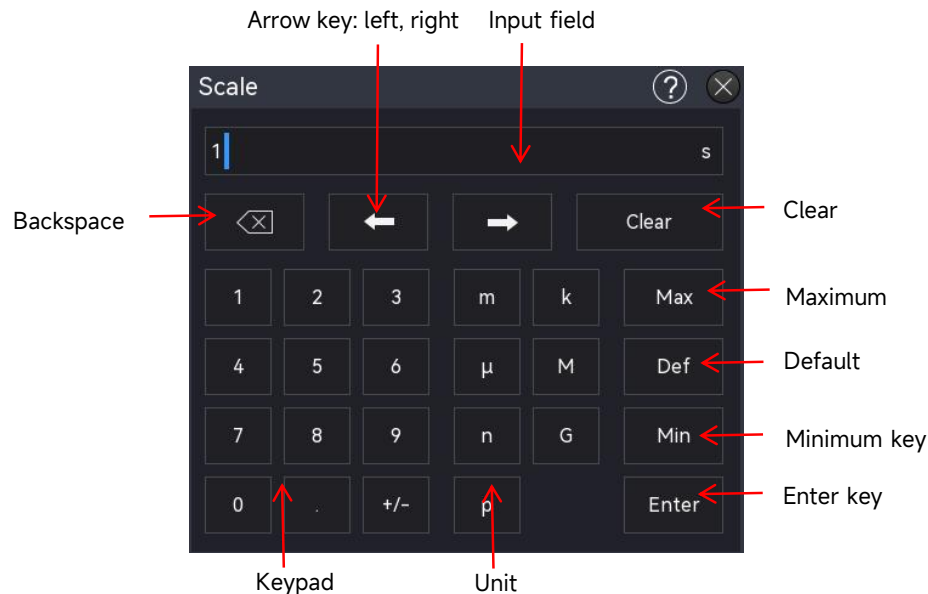

After entering all the values and selecting the desired units, the numeric keypad will automatically close, completing the parameter setting. Additionally, the user can manually close the numeric keypad by clicking the confirm key, in which case the unit will default to the preset unit. On the numeric keypad, you can also perform the following operations:

- a. Delete the entered parameter value.
 - b. Set the parameter to the maximum or minimum value (sometimes specifically the maximum or minimum value for the current state).
 - c. Set the parameter to the default value.
 - d. Clear the parameter input field.
 - e. Move the cursor to modify the parameter value.
2. Enter binary, hexadecimal system value
- During the decoding trigger, use the numeric keypad to enter binary or hexadecimal values for data and address settings.

Enter Method: Tap to select the number or input field to be edited, and then use the

numeric keypad to enter the desired numeric or letter values

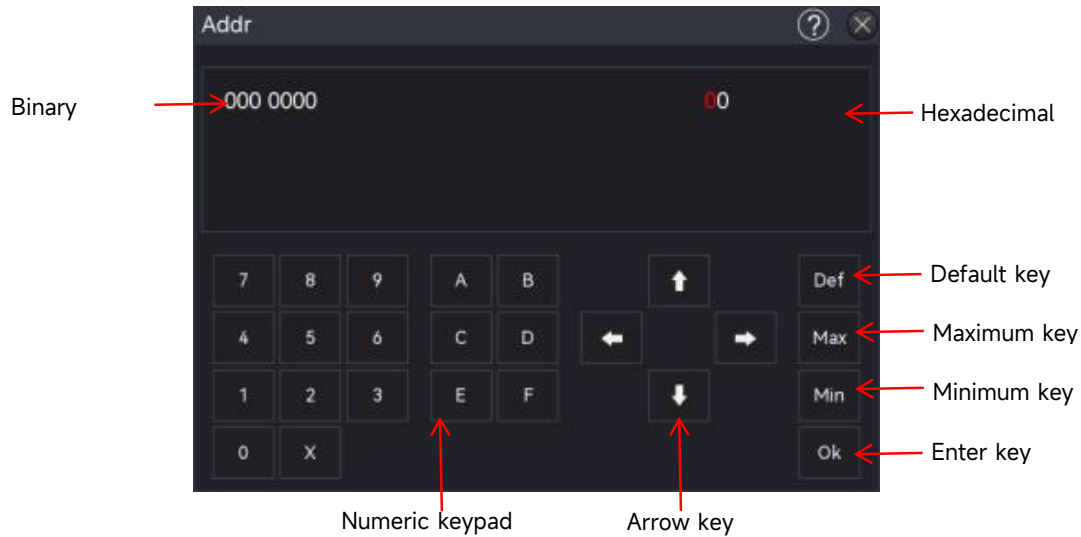

- (4) After entering all the values and pressing the “Ok” button, the numeric keypad will automatically close, completing the parameter setting. Additionally, on the numeric keypad, you can perform the following operations:
- Move the cursor to modify the parameter value.
 - Set the parameter to the maximum or minimum value (sometimes specifically for the current state).
 - Set the parameter to the default value.
 - Clear the parameter input field.

5.9. Remote Control

MSO1000HD series high-resolution oscilloscopes can communicate with a PC via USB and LAN port for remote control. Remote control is implemented using SCPI (Standard Commands for Programmable Instruments.)

MSO1000HD series has three methods for remote control.

(1) Custom Programming

The user can perform the programming control on the oscilloscope through SCPI (Standard Commands for Programmable Instruments). For detailed descriptions on command and programming, please refer to *MSO1000HD Series High-Resolution Oscilloscopes-Programming Manual*.

(2) PC Software Control (Instrument manager)

The user can use a PC software to remotely control the oscilloscope. The instrument manager can display the oscilloscope screen in real time and control the operation with the mouse. It is recommended to use the PC software provided by UNI-T. It can be downloaded from UNI-T

official website (<https://www.uni-trend.com>).

Operating steps:

- Setup the communication between the instrument and a PC.
- Open the instrument manager software and search the instrument source.
- Right-click to open the oscilloscope, operate the instrument manager to remotely control the oscilloscope. Refer to *Instrument Manager-User Manual* for more details. This device supports remote control through communication with a computer via USB, LAN interfaces. Remote control is implemented using the SCPI command set, allowing users to operate and configure the device remotely.

(3) Web Control

Once the network is connected, users can access a web page via the IP address. After logging in with the username and password, they can control the device. The Web Control feature displays the instrument's screen interface in real-time. It supports web access from PCs, smartphones, and iPads, and allows for both internal and external remote control of the device. For more details on logging into Web Control, refer to the "[Web Access](#)" section.

6. Vertical System

- [Open/Activate/Close Analog Channel](#)
- [Vertical Scale](#)
- [Offset](#)
- [Channel Coupling](#)
- [Bandwidth Limitation](#)
- [Probe Multiplier](#)
- [Inverse Phase](#)
- [Unit](#)
- [Label](#)

MSO1000HD provides a separate vertical control system for each channel. The setup method of the vertical system for each channel is the same. This chapter introduces the vertical channel setting using C1 as an example.

Access the Channel Setting menu using the following method.

- When the channel is active, tap the Channel label to enter the Channel Setting menu.

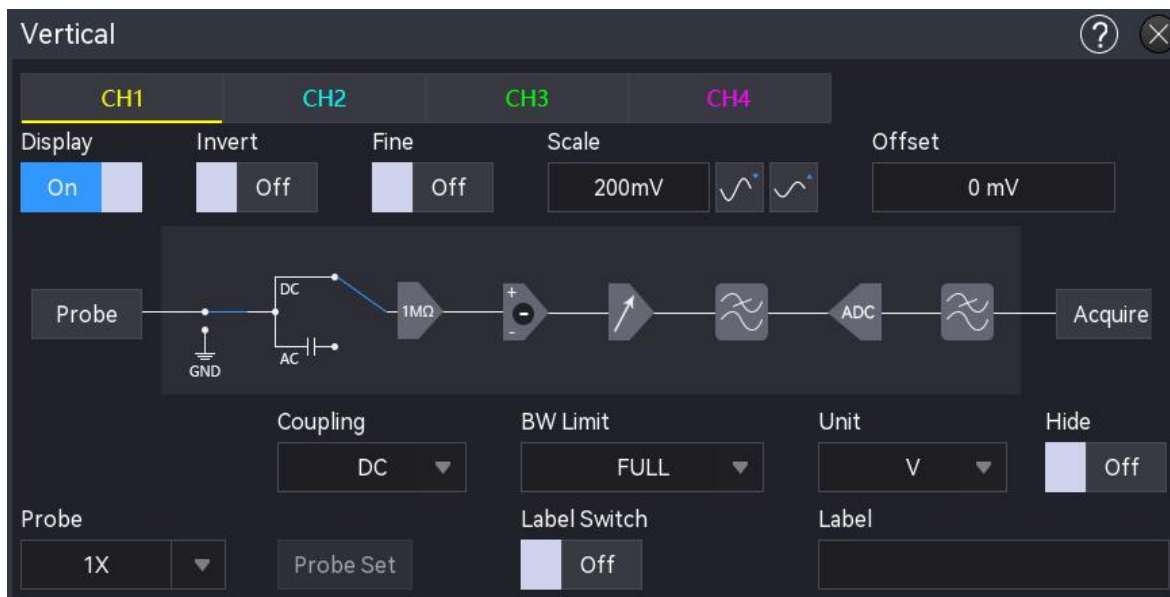

6.1. Open/Activate/Close Analog Channel

C1-C4 analog channels have three states: open, close, and activated.

(1) Open the analog channel

- When an analog channel is turned off, click on the channel key **1** on the front panel to turn on CH1 and the indicator will be illuminated.
- Tap on the channel label at the bottom of the screen to turn on CH1.
- In “Channel Setting” menu, select 'CH1' and set it to ON to turn on CH1, or set it to OFF to turn off CH1.

(2) Close the analog channel

- When CH1 is opened and in the activated state, press the channel key **1** on the front panel or tap on the channel label at the bottom of the screen to turn off CH1.
- When CH1 is opened but not in the activated state. CH1 should be activated at first, and then press the channel key **1** on the front panel or tap on the channel label at the bottom of the screen to turn off CH1.
- Open the “Channel Setting” menu and select “CH1”, set it to OFF to turn off CH1.

(3) Activate the analog channel

When multiple channels are open simultaneously, but only one channel is activated (a channel can only be activated in the open state), the vertical scale, vertical position, and channel settings of the activated channel can be adjusted.

- Press the channel key **1** on the front panel to activate CH1.
- Tap on the channel label at the bottom of the screen to activate CH1.
- Open the “Channel Setting” menu and select “CH1” to activate CH1.

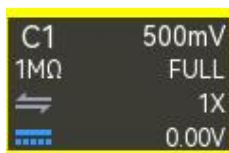

Activated State

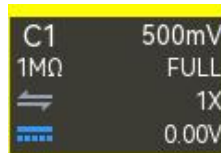

Open but not Activated



Off State

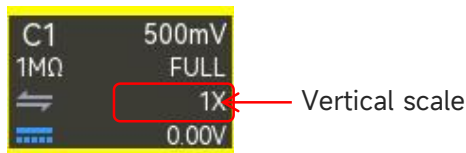

6.2. Vertical Scale

The vertical scale represents the voltage value per division in the vertical direction, typically expressed as V/div. When adjusting the vertical scale, the waveform's amplitude will increase or decrease, and the scale displayed in the channel label at the bottom of the screen will update in real-time (as shown in the figure below).



The vertical scale range depends on the currently selected probe and input impedance. The default probe ratio is 1X. When the input impedance is set to 1 M Ω , the vertical scale range is from 500 μ V/div to 10 V/div. When the input impedance is set to 50 Ω , the vertical scale range is from 500 μ V/div to 1 V/div.

When CH1 is active, adjust the vertical scale using the following steps.

- Use the vertical Scale rotary knob on the front panel to set the vertical scale.
 - Clockwise:** Turn clockwise to decrease the vertical scale.
 - Counterclockwise:** Turn counterclockwise to increase the vertical scale.
- Tap the screen, use a pinch gesture to adjust the vertical scale.
- Open the “Channel Setting” menu, select CH1, double-click on the “Vertical Scale” menu to open the numeric keypad to enter the vertical scale value. For details on the use of the numeric keypad, refer to the section of [5.8 Parameter Setting](#). You can also adjust the vertical scale value by rotating the Multipurpose A rotary knob, or by clicking the icon ,  on the right.

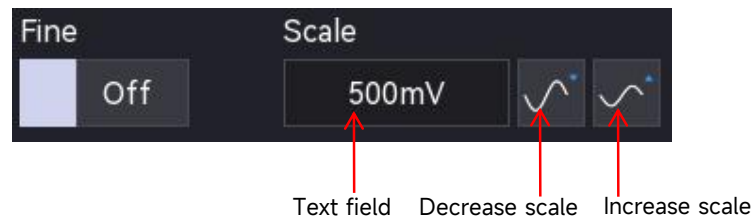

MSO1000HD series supports vertical adjustment. In the “Channel Setting” menu, the adjustment method can set to “Coarse tuning” or “Fine tuning”. “ON” indicates coarse tuning, “OFF” indicates fine tuning. The default is coarse tuning. Press the vertical Scale rotary knob on the right side of the front panel to toggle between “Coarse tuning” and “Fine tuning”.

- **Coarse** tuning: Click the “Decrease Scale” or “Increase Scale” key on the right side of the vertical scale tab. The vertical time base for all channel waveforms will be adjusted within the allowable range using the 1-2-5 step sequence.
- **Fine** tuning: Change the vertical scale by the step of 1% within the current vertical scale range. If the current scale is 100 mV, when the vertical scale is fine-tuned to 50 mV, adjust with $(100-50)/100$ mV; when the vertical scale is fine-tuned to 200 mV, adjust with $(200-10)/100$ mV.

Note: Fine adjustment is enabled by default when adjusting the vertical scale via the touch panel.

6.3. Offset

The vertical offset indicates that the offset of the channel signal zero position of a waveform relative to the center of the screen in the vertical direction. When adjusting the vertical offset, the waveform of a channel will move up and down, and the vertical offset in the channel label at the bottom of the screen will change in real time (as shown in the following figure). The range of the vertical offset is related to the current input impedance, probe ratio and the vertical scale.

vertical scale	Offset range
500 μ V/div - 50 mV/div	± 2 V
51 mV/div - 1 V/div	± 25 V
1.02 V/div - 10 V/div	± 250 V



When CH1 is in the activated state, the vertical offset can be set by the following steps.

- Open the “Channel Setting” menu, enter CH1 tab and Double-click on the “Offset” input field to open the numeric keypad to directly enter the offset value. For details on the use of the numeric keypad, refer to the section of [5.8 Parameter Setting](#).
- Click on the “Offset” input field, rotate the Multipurpose A rotary knob on the front panel to change the vertical scale.

6.4. Channel Coupling

The channel coupling is used to filter out unwanted signals. For example, the measured signal is a signal containing DC offset.

Click the channel label at the bottom of the screen to open the “Channel Setting” menu, and then click on “Coupling” to select the coupling mode.

- **DC:** When the coupling mode is “DC”, the measured signal containing DC component and AC component can all be passed through.
- **AC:** When the coupling mode is “AC”, the measured signal containing DC component will be blocked.
- **Ground:** When the coupling mode is “Ground”, the measured signal containing DC component and AC component will all be blocked.

Once the channel coupling is set, the channel coupling mode will display in the channel label at the bottom of the screen, as shown in the following figure.

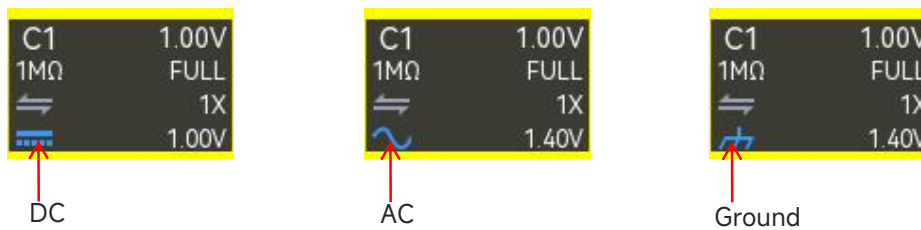

6.5. Bandwidth Limitation

The bandwidth limitation is used to decrease the noise in the waveform. It is mainly used to reduce high-frequency noise in a signal when observing low-frequency signals. For example, the measured signal is a pulse signal containing high-frequency oscillation.

Click the channel label at the bottom of the screen to open the “Channel Setting” menu, and then click on “Bandwidth Limitation” to select the value of bandwidth limitation. When the bandwidth limitation is enabled, the value of bandwidth limitation will be displayed in the channel label at the bottom of the screen, as shown in the following figure.



MSO1000HD series can set the bandwidth limitation to 20 MHz or FULL.

- **20 MHz:** When the measured signal contains the high-frequency that greater than 20 MHz, it will be attenuated.
- **FULL:** The measured signal containing the high frequency can be passed through.
- **Digital bandwidth:** A finite impulse response (FIR) filter is used to achieve oscilloscope bandwidth tunability. It can ensure arbitrary amplitude-frequency characteristics while maintaining strictly linear phase-frequency characteristics; its unit sampling response is finite in length. Digital bandwidth processing, in the backend of digital signal processing, can filter signals for both UPO and DSO waveform displays. This filter can be widely used in automotive electronics, power supplies, motor testing, and other fields, effectively filtering out noise and interference. The digital bandwidth can be set in the range of 50 Hz to 250 MHz.

6.6. Probe Attenuation Ratio

To match the probe attenuation ratio, adjust it in the channel operation menu. For example, with a probe attenuation ratio of 10:1, the probe attenuates the measured signal by a factor of 10 before it reaches the oscilloscope. Therefore, the probe coefficient in the oscilloscope's channel menu should be set to $\times 10$, meaning the incoming signal will be multiplied by 10 to ensure that the oscilloscope reads the correct voltage.

Click the channel tab at the bottom of the screen to open the “Channel Settings” menu. Then, click the “Probe” drop-down menu to select the appropriate probe multiplier.

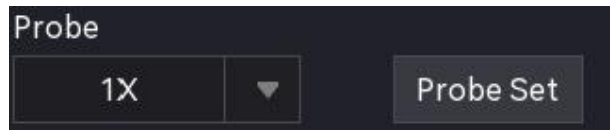

Probe multiplier: 0.001X, 0.01X, 0.1X, 1X, 10X, 100X, 1000X, and custom value.

When the channel unit is set to A, it indicates a current probe, and the probe multiplier can be adjusted to 5 mV/A, 10 mV/A, 50 mV/A, 100 mV/A, 200 mV/A, 5000 mV/A, 1 V/A, or a custom value

6.7. Inverse Phase

Click the channel tab at the bottom of the screen to open the “Channel Setting” menu, and then click on “Inverse Phase” to switch it on or off. When the inverse phase is enabled, an icon  in the channel label will be illuminated.

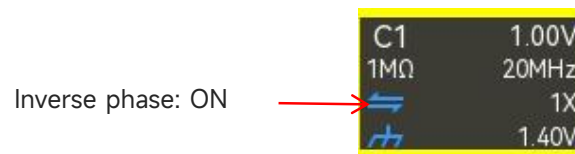

When the inverse phase is disabled, the waveform is displayed normally. When the inverse phase is enabled, the waveform voltage will be reversed, and the results of math operation and waveform measurement will also be changed, as shown in the following figure.



Inverse Phase: ON

Inverse Phase: OFF

6.8. Unit

Click the channel tab at the bottom of the screen to open the “Channel Setting” menu, and then click on the “Unit” to set the unit to “V”, “A”, “W”, or “U”. The default unit is V. When using the current probe, the unit switches to “A”. Once the unit is set, the unit in the channel label and the measurement unit will also be changed.

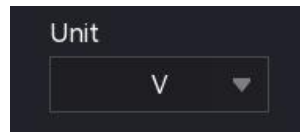

6.9. Channel Fold

Click the “Channel Fold” to set the channel’s waveform state to hide (ON) or display (OFF).

ON: When the “Channel Fold” is set to ON, the channel’s waveform is not displayed.

OFF: When the “Channel Fold” is set to OFF, the channel’s waveform is not displayed normally

6.10. Label

The instrument uses the channel number to identify the channel by default, but you can set a different name for each channel to suit your preferences. For example, CH1.

Click the channel tab at the bottom of the screen to open the “Channel Setting” menu, and then click on “Label” to select display (ON) or not display (OFF) the channel label. The channel label can also be set by double-click on the input field to pop up the virtual keyboard to directly enter the character string. For details on the use of the virtual keyboard, refer to the section of [5.8 Parameter Setting](#).

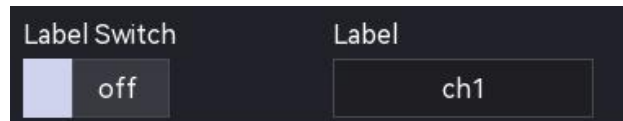

7. Horizontal System

- [Horizontal Scale](#)
- [Horizontal Extension](#)
- [Auto Roll Mode](#)
- [Fastest Roll Time Base](#)
- [Horizontal Position](#)
- [Time Base Extension](#)
- [XY](#)

Access the Horizontal Control System menu using the following method.

- Press the Menu key to enter “Horizontal” menu.
- Tap the horizontal tab on the top to enter “Horizontal” menu.

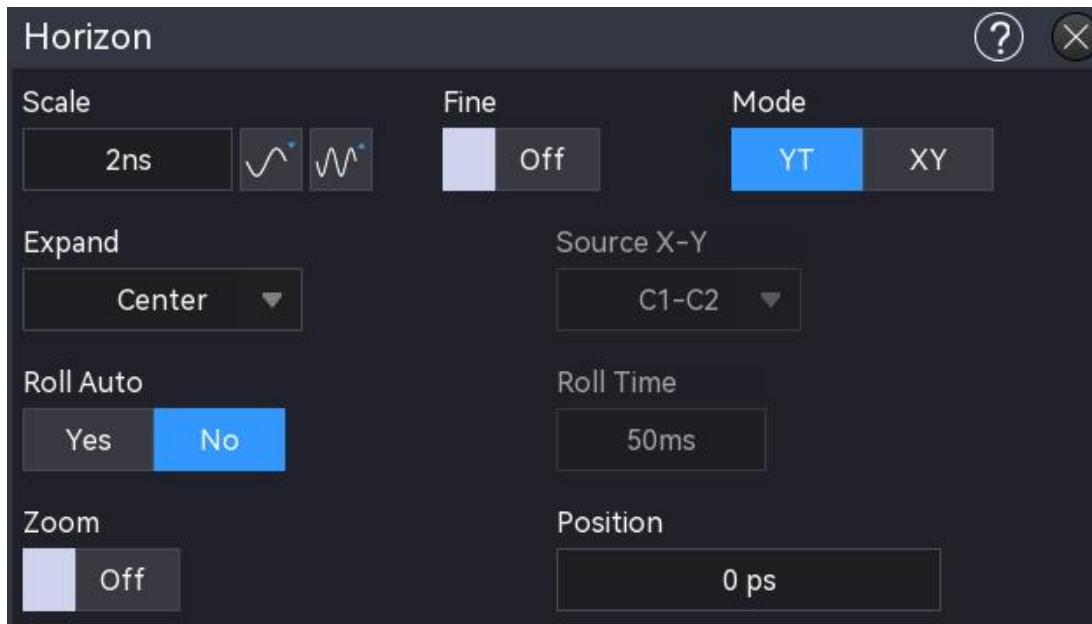
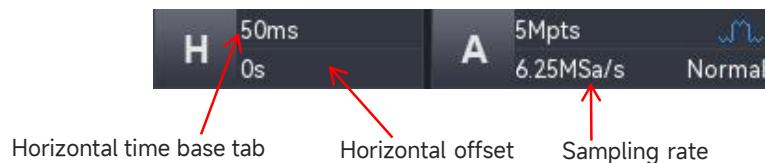

7.1. Horizontal Scale



The horizontal scale is also known as the horizontal time base, i.e., the time value represented by each scale in the horizontal direction of the screen, usually expressed as s/div. The range of horizontal scales as shown in the following table. When adjusting the horizontal time base, it changes in step of 1-2-5, i.e. 10ns/div, 20 ns/div, 50 ns/div...500 s/div, and 1 ks/div.

Model	Range
MSO1254HD MSO1154HD MSO1254HD-S MSO1154HD-S	2 ns/div - 1 ks/div

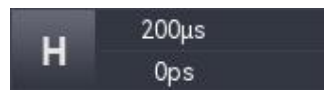
When the horizontal time base is changed, the waveform of all channels will be horizontally extended or compressed with respect to the currently selected horizontal extension reference (see horizontal extension), and the horizontal time base on the top left will change in real time (as shown in the following figure).





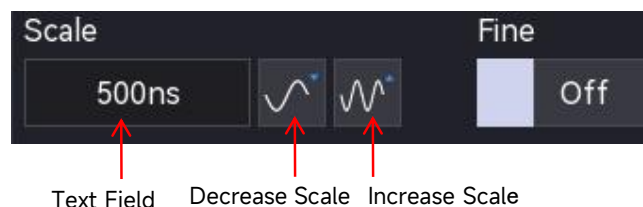

Set the horizontal time base using the following steps.

- Use the horizontal Scale rotary knob on the front panel to set the horizontal scale.
 - Clockwise:** Turn clockwise to decrease the horizontal scale.
 - Counterclockwise:** Turn counterclockwise to increase the horizontal scale.
- Tap the screen, use a pinch gesture to adjust the horizontal scale.
- Tap the **H (Horizontal Scale)** tab on the top to enter the “Horizontal” menu, double-click on the “Horizontal Scale” input field to open the numeric keypad to directly enter the horizontal scale value. For details on the use of the numeric keypad, refer to the section of [5.8 Parameter Setting](#). You can also adjust the horizontal scale value by rotating the Multipurpose A rotary knob, or by clicking the icon ,  on the right.



MSO1000HD series supports horizontal adjustment. In the “Channel Setting” menu, the adjustment method can set to “Coarse tuning” or “Fine tuning”. “ON” indicates coarse tuning, “OFF” indicates fine tuning. The default is coarse tuning. Press the horizontal Scale rotary knob

on the right side of the front panel to toggle between “Coarse tuning” and “Fine tuning”.

- **Coarse tuning:** Click the “ Decrease Scale” or “ Increase Scale” key on the right side of the horizontal scale tab. The horizontal time base for all channel waveforms will be adjusted within the allowable range using the 1-2-5 step sequence.
- **Fine tuning:** Click the “ Decrease Scale” or “ Increase Scale” key on the right side of the horizontal scale tab. The horizontal time base can further adjust all channel waveforms within the allowable range using the 1-2-5 step sequence.

7.2. Horizontal Extension

The horizontal extension refers to the reference position for horizontal extension and horizontal compression when adjusting the horizontal time base. In “Horizontal” menu, select “Horizontal Extension” to set the reference position to “Center”, “Left”, “Right”, or “Trigger point”. The default is “Center”.

- **Center:** When adjusting the horizontal time base, the waveform is expanded or compressed horizontally around the center of the screen.
- **Left:** When adjusting the horizontal time base, the waveform is expanded or compressed horizontally around the far left.
- **Right:** When adjusting the horizontal time base, the waveform is expanded or compressed horizontally around the far right.
- **Trigger point:** When adjusting the horizontal time base, the waveform is expanded or compressed horizontally around the trigger point.

7.3. Auto Roll Mode

Click on the “Auto Roll Mode” menu, set whether to enter SCAN or ROLL when the current time base is slower than the fastest roll time base. It can toggle between “Yes” and “No”.

- **Yes:** When the time base is slower than the fastest roll time base, the oscilloscope will enter the ROLL mode. In this mode, the oscilloscope continuously draws the voltage-time tendency of the waveform on the screen. The waveform is refreshed from right to left and the latest waveform is drawn on the far right.

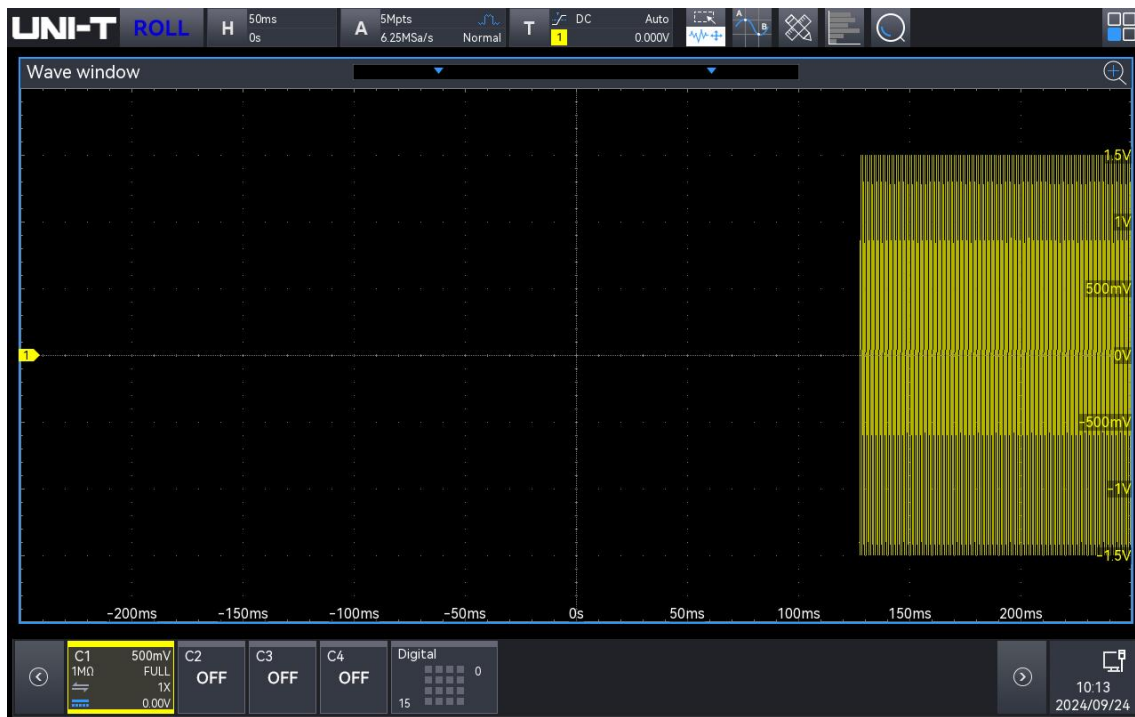

- No:** When the time base is slower than the fastest roll time base, the oscilloscope will not enter the ROLL mode and will be in SCAN state. In the SCAN state, the oscilloscope enters the slow sweep mode. When using the slow sweep mode to observe the low-frequency signal, it is recommended that the channel coupling is set to DC. In this mode, the waveform starts from the trigger position, refreshing from left to right, with the latest waveform drawn on the far left.

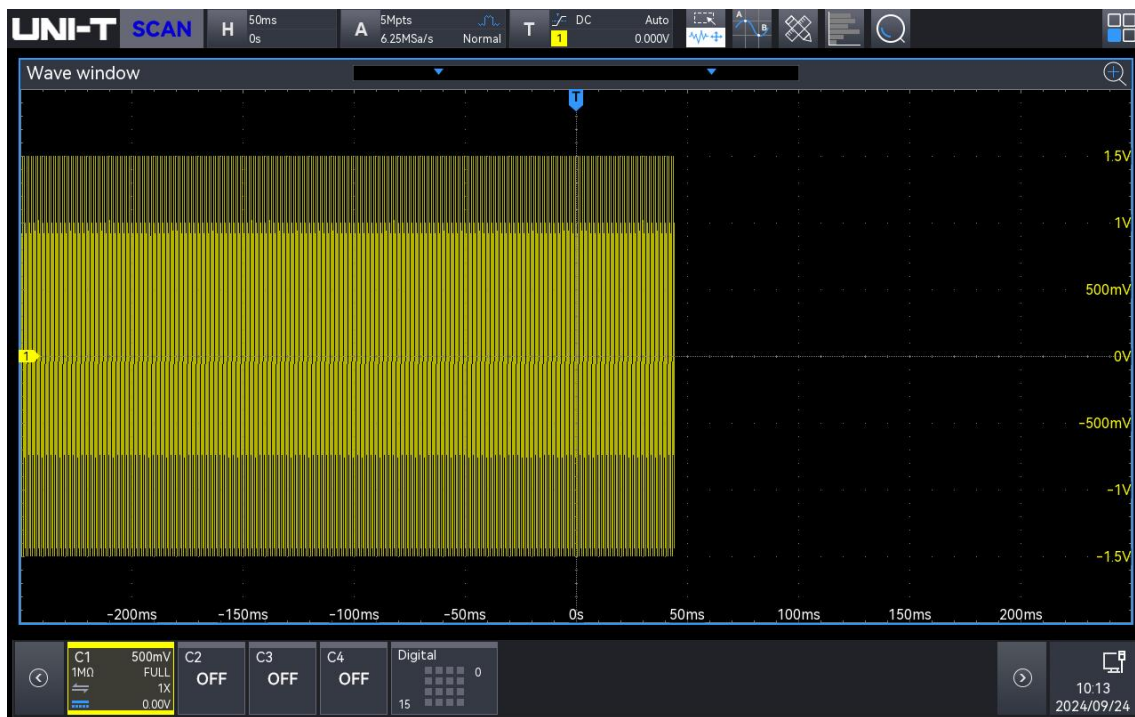

7.4. Fastest Roll Time Base

The fastest scrolling time base enters the time base mode of ROLL or SCAN, with only a prompt function and does not support setting.

7.5. Horizontal Position

Tap on the “Horizontal Position” input field to change its value. Set the horizontal center as the zero point, the waveform will move to the left if the horizontal position is greater than 0; the waveform will move to the right if the horizontal position is less than 0.

Set the horizontal position using the following steps.

- Rotate the Multipurpose A rotary knob on the front panel to adjust the value.
Clockwise: Turn clockwise to decrease the value.
Counterclockwise: turn counterclockwise to increase the value.
- Rotate the horizontal Position rotary knob to adjust the horizontal position.
Clockwise: Turn clockwise to decrease the value.
Counterclockwise: turn counterclockwise to increase the value.
- Double-click on “Horizontal Position” input field to open the numeric keypad to directly enter the value. For details on the use of the numeric keypad, refer to the section of [5.8 Parameter Setting](#).

7.6. Time Base Extension

The time base extension is used to horizontally enlarge a waveform for examining more details, helping users gain a better understanding of the signal. Follow these steps to enable the window extension.

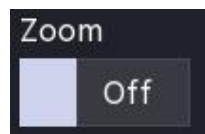

- Tap the **H** (Horizontal Scale) tab on the top to enter the “Horizontal” menu, select the “Horizontal” menu, click on the “Time Base Extension” option and toggle it ON or OFF.
ON: turns on the time base extension.
OFF: turns off the time base extension.
- Tap the icon $+$ in the top right of the screen to quickly open the time base extension, tap the icon $-$ to exit time base extension.

(1) Enlarge Waveform

When the window is extended, you can adjust the horizontal and vertical position magnification of the waveform in the main window.

Set the magnification using the following steps.

- Double-click on the “Horiz Zoom” and “Vert Zoom” input field on the screen to open the numeric keypad to directly enter the value. For details on the use of the numeric keypad, refer to the section of [5.8 Parameter Setting](#).
- Tap “+” or “-” next to “Horiz Zoom” and “Vert Zoom” input field on the screen to increase or decrease the numeric value.
- Click to select “Horiz Zoom” and “Vert Zoom” input field, use the [Multipurpose A](#) rotary knob to adjust the value.
- Drag the four borders of the magnified area in the main window to define the region of the waveform to be enlarged.

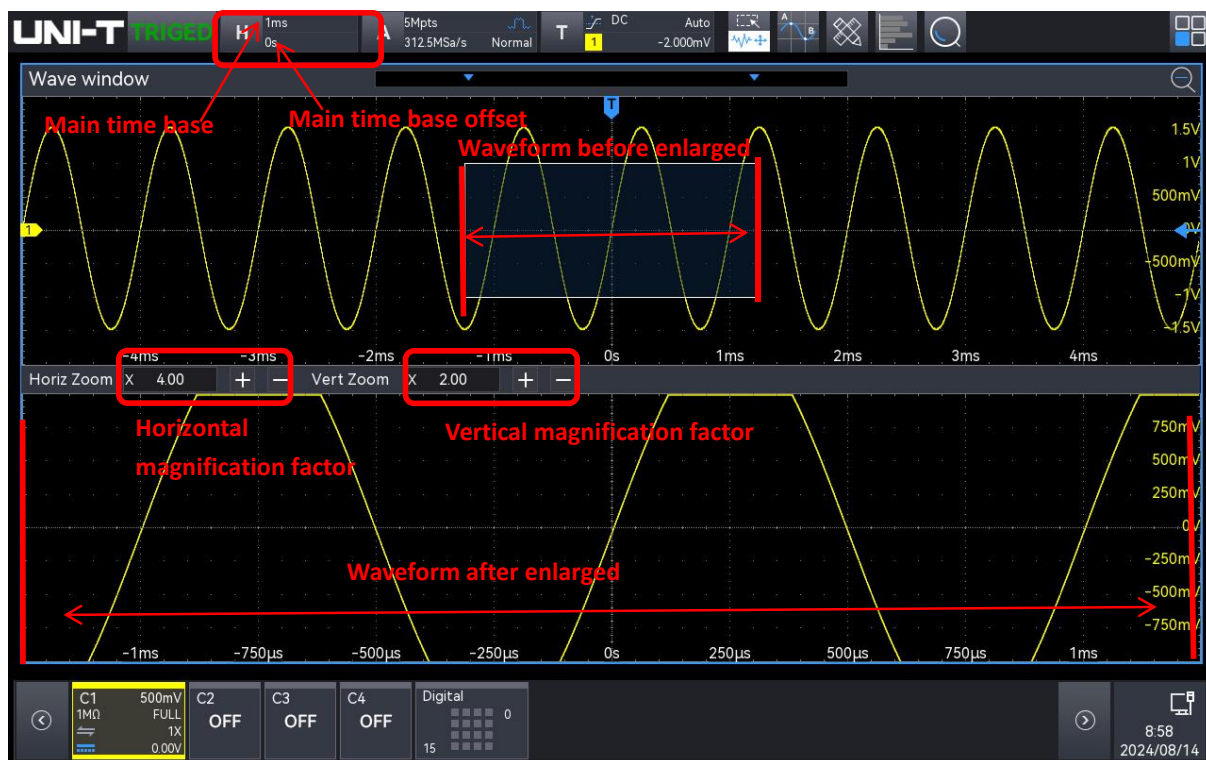

(2) Waveform before Enlarged

The enlarged waveform, displayed with a shadow in the upper part of the screen, can be moved using the horizontal [Position](#) rotary knob or zoomed in and out by adjusting the horizontal [Scale](#) rotary knob.

(3) Waveform after Enlarged

The horizontally enlarged waveform is displayed in the lower part of the screen, and the window

extension improves the resolution relative to the main time base.

Note: The window extension is only available when the horizontal time base is set to the fastest roll time base. When the time base extension is enabled in ROLL mode, the main time base will default to the fastest roll time base.

7.7. XY

The waveform displayed in XY mode is also known as a Lissajous curve. XY mode supports cursor measurements, allowing for quick measurement of the phase difference between two signals.

- (1) Time Base Format
 - a. YT: Displays the voltage value on the time base (horizontal scale).
 - b. XY: Displays Lissajous curve, it can easily measure the phase difference between two signals with same frequency.
- (2) Display: When XY mode is enabled, the channel waveform and XY curve are displayed in a split screen by default.
- (3) Source X - Y:

Set the waveform to generate a Lissajous curve, which can be select from C1-C2, C1-C3, C1-C4, C2-C3, C2-C4, or C3-C4.

If "X-Y" is set to C1-C2, input the CH1 signal on the horizontal axis (X) and the CH2 signal on the vertical axis (Y).

If "X-Y" is set to C1-C2, input the CH1 signal on the horizontal axis (X) and the CH2 signal on the vertical axis (Y).

In XY mode, when CH1 or CH3 is active, use the vertical Position rotary knob to move the XY curve horizontally. When CH2 or CH4 is active, use the vertical Position rotary knob to move the XY curve vertically.

The amplitude of each channel can be adjusted using the vertical Scale rotary knob. The time base can be adjusted using the horizontal Scale rotary knob to improve the display of the Lissajous curve. The waveform in XY mode is shown in the following figure.

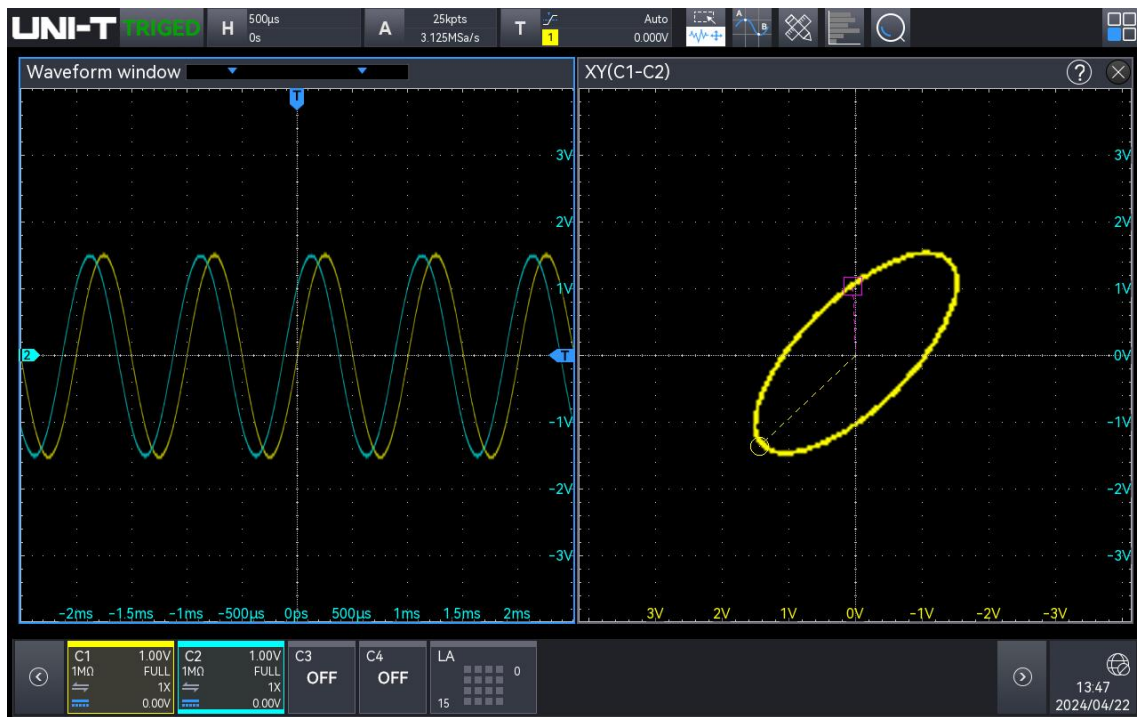

In this state, set the menu to display in split screen, and press the **Cursor** key, as shown in the following figure.

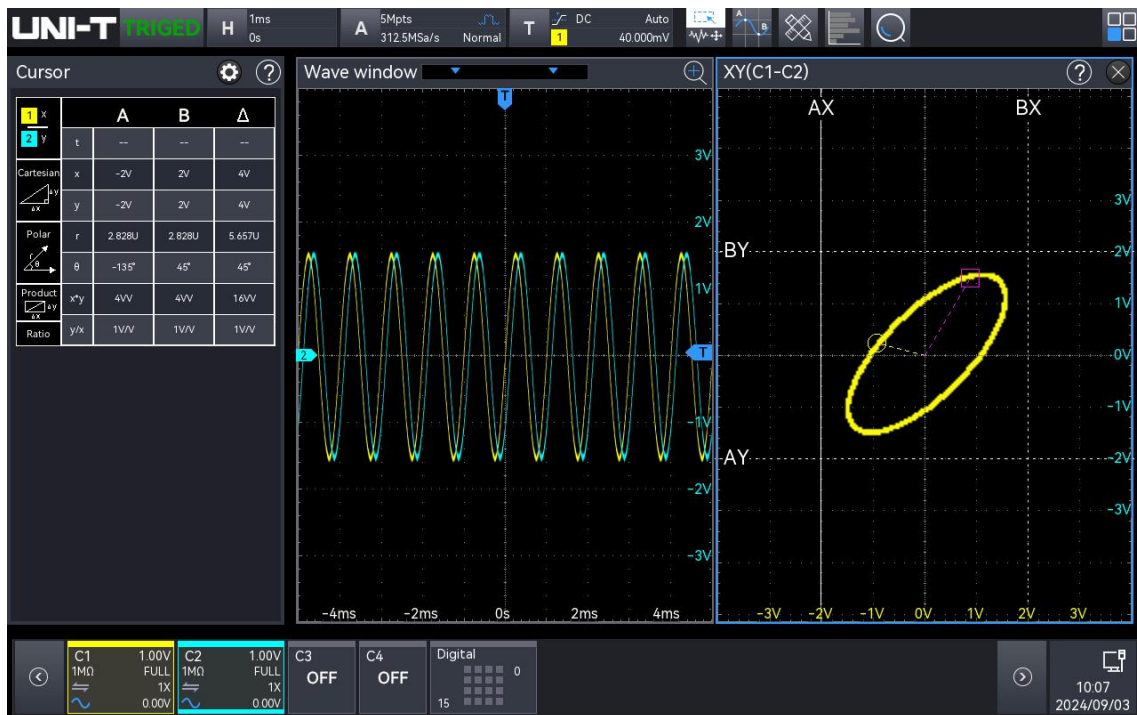

When XY mode is enabled, the cursor supports both time and voltage measurements. For time measurement, the cursor is displayed in the waveform window, and you can move it only within the waveform window. For voltage measurement, the cursor is displayed in the XY window. Refer to the [Cursor Measurement](#) section for details on time and voltage cursor usage.

Cursor ①: Time, rectangular coordinates, polar coordinates, product, and ratio.

Cursor ②: Time, rectangular coordinate, polar coordinates, product, and proportion.

△: Delta (numerical difference between two cursors).

Application of XY mode

The phase difference between the two signals with the same frequency can be easily observed through Lissajous curve. The following figure explains a schematic diagram for observing the phase difference.

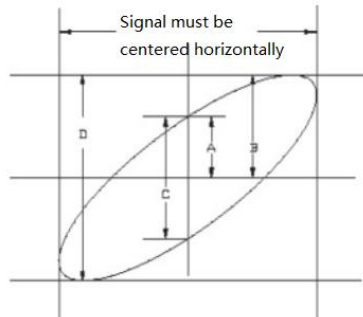

Based on $\sin\theta=A/B$ or C/D , where θ is the phase angle between the channels (with A, B, C, and D defined in the figure above), the phase angle can be calculated as $\theta = \pm \arcsin(A/B)$ or $\theta = \pm \arcsin(C/D)$. If the major axis of the ellipse is in the I or III quadrant, then the resulting phase angle should be in the I or IV quadrant, i.e., within $(0 - \pi/2)$ or $(3\pi/2 - 2\pi)$. If the major axis of the ellipse is in the II or IV quadrant, then the phase angle should be within $(\pi/2 - \pi)$ or $(\pi - 3\pi/2)$.

Additionally, if the frequency or phase difference between the two signals is an integer multiple, calculate the frequency and phase relationship between the two signals based on the following figure.

Phase Angle \ Freq ratio	0	$\frac{1}{4}\pi$	$\frac{1}{2}\pi$	$\frac{3}{4}\pi$	π
1:1					
1:2					
1:3					
2:3					

8. Triggering System

- [Noun Explanation of Triggering System](#)
- [Edge Triggering](#)
- [Pulse Width Triggering](#)
- [Video Triggering](#)
- [Slope Triggering](#)
- [Runt Pulse Triggering](#)
- [Over-amplitude Triggering](#)
- [Delay Triggering](#)
- [Timeout Triggering](#)
- [Duration Triggering](#)
- [Setup & Hold Triggering](#)
- [Nth Edge Triggering](#)
- [Code Pattern Triggering](#)
- [RS232 Triggering](#)
- [I²C Triggering](#)
- [SPI Triggering](#)
- [CAN Triggering](#)
- [CAN-FD Triggering](#)
- [LIN Triggering](#)
- [Audio Triggering](#)
- [Zone Triggering](#)

Triggering refers to setting a condition that must be met for the oscilloscope to capture and display a waveform. When the waveform meets the specified trigger condition, the oscilloscope captures the waveform and its adjacent part, displaying it on the screen. While the oscilloscope continuously captures waveforms during operation, only those that meet stable trigger conditions will be displayed.

The trigger ensures that each time base sweep or acquisition starts from a defined condition, synchronizing each scan with the acquisition. This synchronization ensures that the acquired waveforms overlap and provide a stable display.

Trigger settings determine when the oscilloscope acquires and displays data based on the characteristics of the input signal. For example, setting the trigger to activate on the rising edge of the analog channel 1 input signal enables the user to capture the desired waveform more efficiently. Understanding the signal under test is crucial for quickly acquiring the desired waveform.

MSO1000HD series offers several advanced trigger types, including various serial bus triggers. This chapter describes each trigger type in detail.

Advanced protocol triggered decoding supports the models and standards listed in the table below:

Option Name	Description	Models	Standard
Computer serial bus triggering and analysis	RS - 232/422/485/UART	MSO1000HD Series	Standard
Embedded serial bus triggering and analysis	I ² C, SPI	MSO1000HD Series	Standard
Automobile serial bus triggering and analysis	CAN, LIN	MSO1000HD Series	Standard
Automobile serial bus triggering and analysis	CAN-FD	MSO1000HD Series	Standard
Audio serial bus triggering and analysis	Audio, LJ, RJ, TDM	MSO1000HD Series	Standard

Follow the steps below to access the “Trigger” menu.

- Press the **Menu** key on the front panel to enter the “Trigger Setting” menu.
- Tap the T trigger label on the top (as shown in the following figure) to enter the “Trigger Setting” menu.



8.1. Noun Explanation of Triggering System

(1) Trigger Source

A signal is used to generate a trigger. The trigger can be obtained from various sources, such as analog channels (C1-C4), digital signals (D0-D15), or mains electricity.

- a. Select any of the analog signal input ports C1-C4 on the front panel of the oscilloscope as the trigger signal.
- b. When a digital signal is connected and the digital channels are enabled, select any of the digital channels as the trigger signal.
- c. Mains electricity: This source is used to observe signals related to mains electricity, such as the relationship between lighting equipment and power supply equipment, to achieve stable synchronization.

Press the trigger Menu soft key on the front panel or tap the T trigger label on the top to open the "Trigger" menu, tap "Source" to set the trigger source.

(2) Trigger Mode

The trigger mode is used to determine how the oscilloscope behaves during the trigger condition. The following is a brief introduction to the trigger acquisition process of the oscilloscope through the pre-trigger buffer and the post-trigger buffer.

When the oscilloscope is operating, the pre-trigger buffer is filled first, continuously storing data as the system searches for a trigger event. The data is transferred to the pre-trigger buffer in a FIFO (First In, First Out) manner. Once a trigger event is detected, the pre-trigger buffer contains data captured before the trigger. The oscilloscope then proceeds to fill the post-trigger buffer with the data captured after the trigger and displays the sampled waveform.

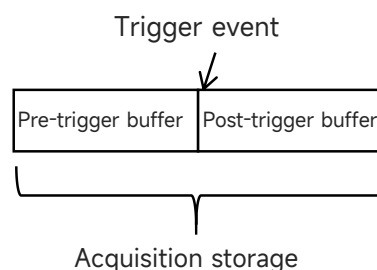

This oscilloscope provides three trigger modes: auto, normal, and single. Set the trigger mode using the following steps.

- Press the Mode softkey in the trigger area on the front panel to switch between the trigger modes.
- Press the Menu softkey in the trigger area on the front panel or tap the **T** trigger label on the top to open the "Trigger" menu to select the desired trigger mode.

- a. Auto: In Auto mode, when no trigger signal is detected, the oscilloscope will automatically collect and display data. Once a trigger signal is generated, the oscilloscope will automatically switch to sweep mode, ensuring signal synchronization. The auto mode is suitable for the following condition.

- Checking DC signal or a signal with unknown electric feature.

Note: In auto mode, the oscilloscope can operate at 50 ms/div or slower when no trigger signal is detected in ROLL mode.

- b. Normal: The oscilloscope collects waveforms only when the trigger condition is met. If no trigger signal is detected, the oscilloscope will stop collecting data and enter a wait state. When the trigger condition is satisfied, the oscilloscope refreshes the waveform on the screen; otherwise, it retains the last triggered waveform.

The normal mode is suitable for the following conditions.

- Only collect the specified event appointed by the trigger setting.
- A rare trigger event. The normal mode can prevent the oscilloscope from automatically triggering, so that the waveform can be displayed stably.

- c. Single: In the single trigger mode, press the **Single** key on the front panel clears the waveform on the screen, and the oscilloscope enters a wait state. When a trigger is detected, the oscilloscope samples and displays the waveform, then enters the STOP state. Press the **Single** key again, the waveform on the screen will be deleted and the oscilloscope will quickly enter the single mode.

The single mode is suitable for the following conditions.

- Capture a single event by accident or non-periodic signal, such as rising or falling waveforms.
- A rare trigger event.

(3) Trigger Coupling

Trigger coupling determines which part of the signal will be transmitted to the trigger circuit. This setting is available only when the edge trigger is selected, and the trigger source is an analogue channel.

Press the **Menu** softkey on the front panel or tap the **T** trigger label on the top to enter the "Trigger" menu. Click on the "Trigger Coupling" to select the desired trigger coupling mode (Default: DC).

- DC: Passes all DC and AC components of the signal.
- AC: Blocks the DC component of the signal.
- HF reject: Attenuates high-frequency components above 40 kHz.

- d. LF reject: Attenuates low-frequency components below 40 kHz.

(4) Trigger Level

Trigger level is used to set the edge position of trigger point, and the trigger level is related to the trigger source.

- When the trigger source is C1-C4, rotate the Position rotary knob on the right to adjust the trigger level. If the trigger window is opened, tap on the trigger level and then rotate the Multipurpose A rotary knob to adjust the trigger level; or double-click on the "Trigger Level" input field to open the virtual keyboard to set the trigger level. For details on the use of the numeric keypad, refer to the section of [5.8 Parameter Setting](#). During this process, a trigger level line (the color is consistent with the channel color) and a trigger icon  will appear on the screen, this line will move up and down according to the change of trigger level. Once the adjustment is stopped, the trigger level line will disappear after 2 seconds. The current trigger level is displayed in the trigger label on the screen.

For runt-amplitude trigger, ramp trigger and over-amplitude trigger, high level and low level must be set. If the trigger window is opened, tap on "High" or "Low" and rotate the Multipurpose A rotary knob to set the high or low level; or open the virtual keyboard to set the trigger level. Two trigger level icons  are displayed on the right.

- When the trigger source is AC Line, it has no trigger level.
- When the trigger source is EXT, rotate the Position rotary knob on the right to adjust the trigger level; If the trigger window is opened, tap on the trigger level and then rotate the Multipurpose A rotary knob to adjust the trigger level; or double-click on the "Trigger level" input field to open the virtual keyboard to set the trigger level. For details on the use of the numeric keypad, refer to the section of [5.8 Parameter Setting](#). The current trigger level is displayed in the trigger label on the screen. For this trigger source, only the trigger level change is displayed, but no trigger level line.

(5) Trigger Holdoff

Trigger holdoff is used to stabilize the display of complex or overlapping waveforms, such as pulse trains with multiple edges or events. It specifies the amount of time the oscilloscope waits before restarting the trigger circuit after a trigger condition is met. During the trigger holdoff, even if the trigger condition is met, the oscilloscope will not trigger until the end of holdoff time. For example, a set of pulse trains that require triggering on the first pulse of the train, then the holdoff time can be set to the width of the pulse train.

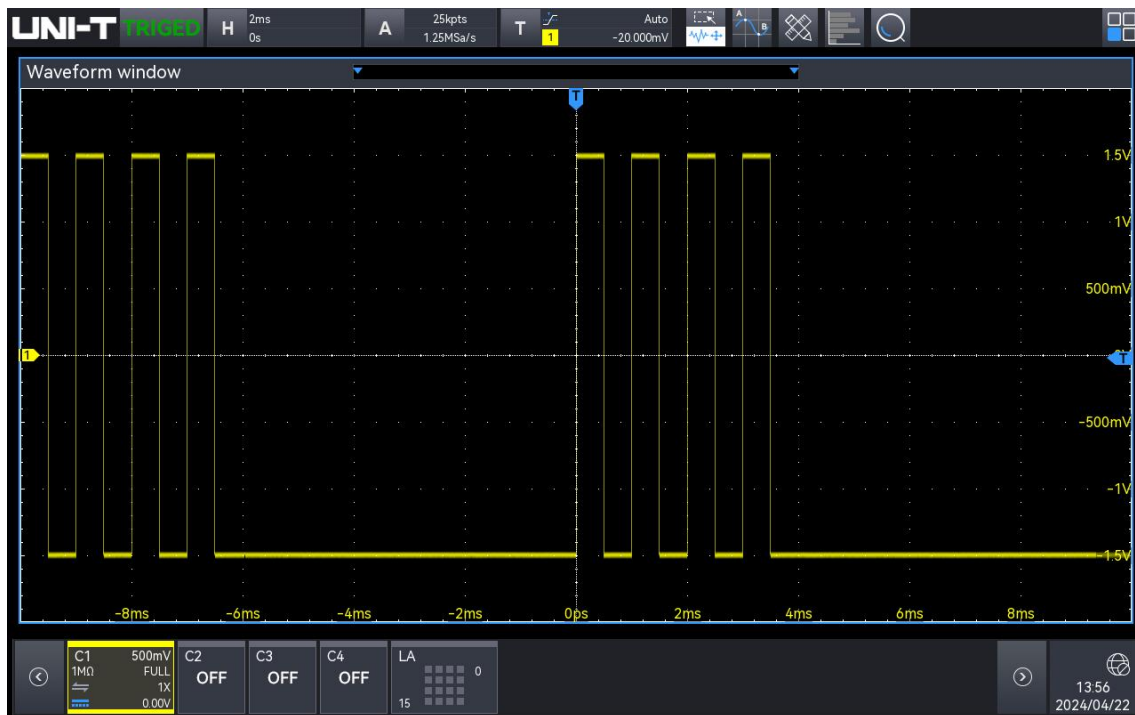

Press the **Menu** softkey on the front panel or tap the **T** trigger label on the top to enter the “Trigger” menu. Click on the “Trigger Holdoff” input field to open the numeric keypad to set the trigger holdoff time (until the waveform is stably triggered, the default is 80 ns). For details on the use of the numeric keypad, refer to the section of [5.8 Parameter Setting](#). Alternatively, rotate the **Multipurpose A** rotary knob on the front panel to set the trigger holdoff time. The adjustable range is from 0 s to 10 s.

(6) Noise Rejection

Noise rejection is used to attenuate the high-frequency noise in a signal, to reduce the error trigger probability of the oscilloscope. Press the Menu softkey on the front panel or tap the **T** trigger label on the top to enter the “Trigger” menu. Click on the “Noise Rejection” to toggle it ON or OFF.

(7) Trigger Sensitivity

When noise is present in the signal, check the trigger sensitivity and adjust it as needed. Adjusting the trigger sensitivity changes the probability of noise triggering the system. The adjustable range is from 0% to 100%.

(8) Force Trigger

Press the **Force** key to manually generate a trigger signal.

If the waveform is not displayed on the screen in the “Normal” or “Single” mode, press the **Force** key to collect the signal baseline, allowing you to confirm that the acquisition is functioning normally.

(9) Pre-trigger/Delay Trigger

The sampled data before trigger event/post-trigger event.

Trigger position is usually set at the horizontal center of the screen. The user can observe 5 grids of pre-trigger and delay information. You can move the waveform horizontally to view more pre-trigger information. By observing the pre-trigger data, the waveform before generated can be observed. For example, capturing the glitch at the start of the circuit, observing and analyzing the pre-trigger data to find out the cause of the glitch.

8.2. Edge Triggering

The edge can be identified by looking for the specified edge (rising edge, falling edge, and rising & falling edge) and electrical level. Press the edge trigger menu to set the source, trigger coupling, trigger mode, edge type, and trigger level. A stable waveform can be generated when the condition is satisfied.

Press the Menu softkey on the front panel or tap the T trigger label on the top to enter the “Trigger” menu. Click on the “Edge Trigger” to set.

(1) Trigger Type

Press the **Menu** softkey on the front panel or tap the **T** trigger label on the top to open the “Trigger” menu. Tap “Trigger Type” to open the dropdown menu, then select “Edge” to configure the trigger settings.

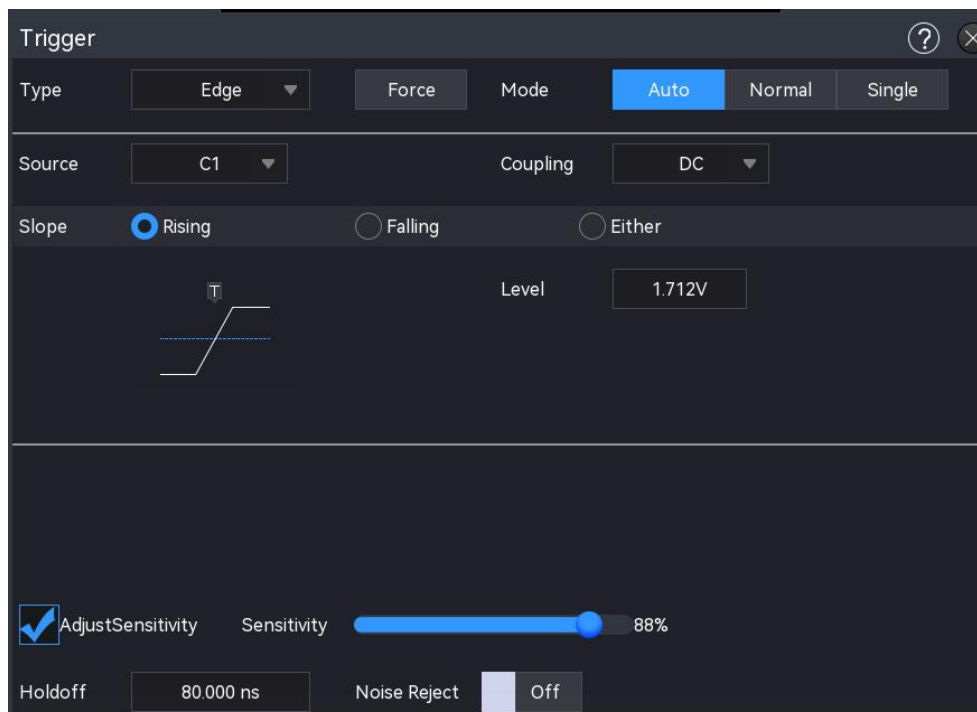

(2) Trigger Mode

Set the trigger mode to auto, normal, or single. For more details on *Trigger Mode*, refer to the

section [Noun Explanation of Triggering System](#).

(3) Source

Click on the “Source” to select C1-C4 or D0-D15. For more details on *Trigger Source*, refer to the section [Noun Explanation of Triggering System](#). The current source is displayed in the trigger label on the top of the screen.

The source can only trigger stably if the selected channel has a connected signal and is set as the trigger source.

(4) Trigger Coupling

Click on the “Trigger Coupling” to select DC, AC, LF reject, or HF reject. For more details on *Trigger Coupling*, refer to the section [Noun Explanation of Triggering System](#).

(5) Edge Type

Select a signal and specify the edge on which to trigger. The current edge type will be displayed in the trigger label at the top of the screen.

- a. Rising edge: Set a signal to trigger on the rising edge.
- b. Falling edge: Set a signal to trigger on the falling edge.
- c. Arbitrary edge: Set a signal to trigger on both the rising and falling edges.

(6) Trigger Level

Tap to select “Level”, the trigger level can be changed by using the [Multipurpose A](#), trigger [Position](#) rotary knob, and the numeric keypad on the front panel. For more details on *Trigger Level*, refer to the section [Noun Explanation of Triggering System](#).

8.3. Pulse Width Triggering

Pulse width triggering sets the oscilloscope to trigger on the specified width and a positive or negative pulse meets the judgment conditions. The pulse width triggering menu can set the source, trigger condition, the upper/lower limit, polarity (positive/negative pulse width trigger), trigger type, trigger mode, and trigger level.

(1) Trigger Type

Press the Menu softkey in the trigger area on the front panel or tap the T trigger label at the top to enter the “Trigger” menu. Tap on the “Trigger Type” to select “Pulse Width”.

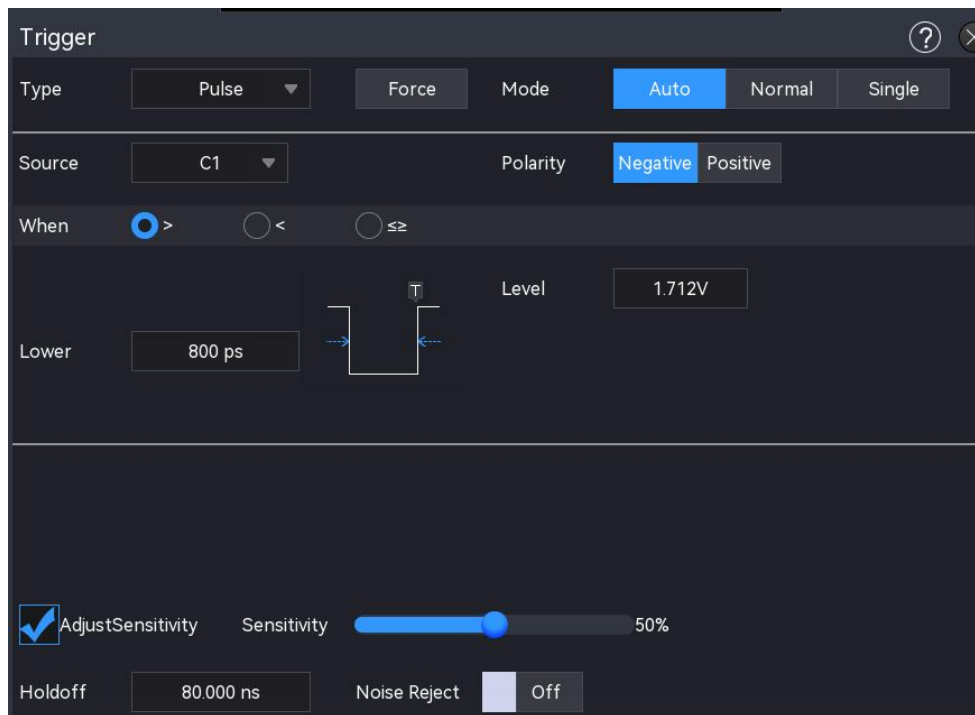

(2) Trigger Mode

Set the trigger mode to auto, normal, or single. For more details on *Trigger Mode*, refer to the section [Noun Explanation of Triggering System](#).

(3) Source

Click on the “Source” to select C1-C4 or D0-D15. For more details on *Trigger Source*, refer to the section [Noun Explanation of Triggering System](#). The current source is displayed in the trigger label at the top of the screen.

The source can only trigger stably if the selected channel has a connected signal and is set as the trigger source.

(4) Trigger Condition

- a. >: When the pulse width of the trigger signal (positive pulse width, negative pulse width) is greater than the set pulse width, the lower limit can be set.
- b. <: When the pulse width of the trigger signal (positive pulse width, negative pulse width) is less than the set pulse width, the upper limit can be set.
- c. \leq : When the pulse width of the trigger signal (positive pulse width, negative pulse width) is the same as the set pulse width or the pulse width of the trigger signal is triggered within the set range, the upper and lower limit can be set.

(5) Upper/Lower Limit

The set pulse width is compared to the pulse width of the trigger signal. The oscilloscope will be generated when the trigger condition is met. The adjustable range is from 1.6 ns to 4 s.

- When the trigger condition is set to “>” or “<”, click on the input field of the lower limit or upper limit to open the numeric keypad to set the lower or upper limit. Alternatively, rotate the Multipurpose A rotary knob on the front panel to adjust the lower or upper limit.
- When the trigger condition is set to “ \leq ”, click on the input field of the lower limit or the upper limit to open the numeric keypad to set the lower or upper limit. Alternatively, rotate the Multipurpose A rotary knob on the front panel to adjust the lower or upper limit. The lower limit must be less than or equal to the upper limit.

(6) Level

Tap to select “Level”, the trigger level can be changed by using the Multipurpose A, trigger Position rotary knob, and the numeric keypad on the front panel. For more details on *Trigger Level*, refer to the section [Noun Explanation of Triggering System](#).

8.4. Video Triggering

The video signal includes the image and the time sequence information. It has multiple standards and formats. MSO1000HD can be triggered on the field or line of the standard video signal, i.e. NTSC (National Television Standards Committee), PAL (Phase Alternating Line), and SECAM (Sequential Couleur A Memoire).

(1) Trigger Type

Press the Menu softkey on the front panel or tap the **T** trigger label on the top to open the “Trigger” menu. Tap “Trigger Type” to open the dropdown menu, then select “Video Trigger” to configure the trigger settings.



(2) Trigger Mode

Set the trigger mode to auto, normal, or single. For more details on *Trigger Mode*, refer to the section [Noun Explanation of Triggering System](#).

(3) Source

Click on the “Source” to select C1-C4. For more details on *Trigger Source*, refer to the section [Noun Explanation of Triggering System](#). The current source is displayed in the trigger label at the top of the screen.

The source can only trigger stably if the selected channel has a connected signal and is set as the trigger source.

(4) Video Format

Click on the “Video Format” to select from the following options.

- a. PAL: The frame frequency is 25 frames per second, the TV scan line is 625 lines, the odd field is in the front and the even field is in the rear.
- b. NTSC: The field frequency is 60 fields per second, and the frame frequency is 30 frames per second. The TV scan line is 525 lines. The even field is in the front and the odd field is in the rear.
- c. SECAM: The frame frequency is 25 frames per second, the TV scan line is 625 lines, interlaced scanning.

Video Format	Frame Frequency (Frame)	Sweep Type	TV Scan Line (Line)
NTSC	30	Interlaced scanning	525
PAL/SECAM	25	Interlaced scanning	625
525 p/60	60	Progressive scanning	525
625 p/50	50	Progressive scanning	625
720 p/24	24	Progressive scanning	750
720 p/25	25	Progressive scanning	750
720 p/30	30	Progressive scanning	750
720 p/50 Hz	50	Progressive scanning	750
720 p/60 Hz	60	Progressive scanning	750
1080 p/24 Hz	24	Progressive scanning	1125
1080 p/25 Hz	25	Progressive scanning	1125
1080 p/30 Hz	30	Progressive scanning	1125
1080 i/25 Hz	25	Progressive scanning	1125
1080 i/30 Hz	30	Progressive scanning	1125
1080 Psf/24	24	Progressive scanning	1125

(5) Sync (Synchronization)

Synchronization can be set to even field, odd field, full field, all lines, or specified lines.

- a. Even field: Triggered on the rising edge of the first sawtooth pulse in the even field. This option is available only for NTSC and PAL/SECAM video formats.
- b. Odd field: Triggered on the rising edge of the first sawtooth pulse in the odd field. This option is available only for NTSC and PAL/SECAM video formats.
- c. Full field: Triggered on the rising edge of the first pulse in the vertical synchronization interval.
- d. All lines: Triggered and synchronized on the first line of the video signal.
- e. Specified lines: Triggered and synchronized on the specified lines. The line number can be set using the Multipurpose A rotary knob. The line number range depends on the video format: 1-525 (NTSC), 1-625 (PAL/SECAM), 1-525 (525p), 1-625 (625p), 1-750 (720p), and 1-1125 (1080p/1080i).

(6) Level

Tap to select "Level", the trigger level can be changed by using the Multipurpose A, trigger Position rotary knob, and the numeric keypad on the front panel. For more details on *Trigger Level*, refer to the section [Noun Explanation of Triggering System](#).

Note : To observe detailed waveforms in the video signal, increase the memory depth.

MSO1000HD series incorporates UNI-T's proprietary digital 3D technology, featuring a multi-level greyscale display. This allows varying brightness levels to indicate the frequency of different signal components, helping experienced users quickly assess signal quality and identify anomalies during debugging.

8.5. Slope Triggering

Slope triggering refers to triggering on the rising or falling edge within a specified time, making it suitable for observing sawtooth and triangular waves. The slope trigger menu allows you to configure the source, trigger mode, edge type (rising or falling), slope condition, upper and lower time limits, and high and low levels.

(1) Trigger Type

Press the **Menu** softkey on the front panel or tap the **T** trigger label on the top to open the "Trigger" menu. Tap "Trigger Type" to open the dropdown menu, then select "Slope Trigger" to configure the trigger settings.

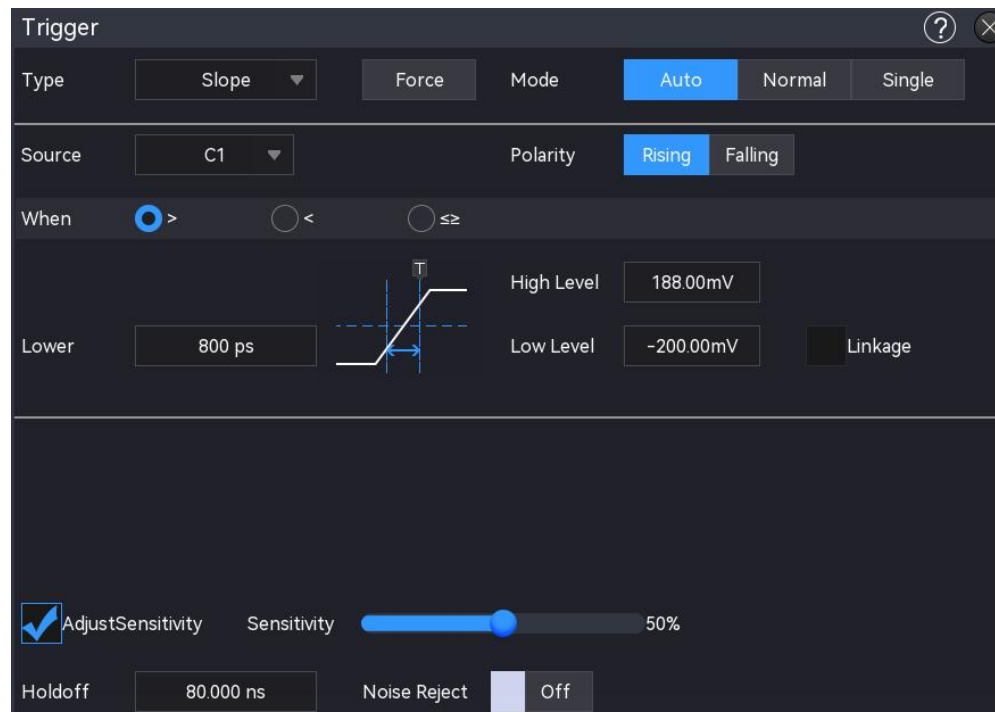

(2) Trigger Mode

Set the trigger mode to auto, normal, or single. For more details on *Trigger Mode*, refer to the section [Noun Explanation of Triggering System](#).

(3) Source

Click on the “Source” to select C1-C4. For more details on *Trigger Source*, refer to the section [Noun Explanation of Triggering System](#). The current source is displayed in the trigger label at the top of the screen.

The source can only trigger stably if the selected channel has a connected signal and is set as the trigger source.

(4) Edge Type

Select the slope trigger edge to rising edge or falling edge.

- a. Rising edge: Uses the rising edge of a trigger signal to perform the slope trigger.
- b. Falling edge: Uses the falling edge of a trigger signal to perform the slope trigger.

(5) Time Condition

- a. $>$: When the slope time of the trigger signal (positive pulse width, negative pulse width) is greater than the set slope time, the lower limit of time can be set.
- b. $<$: When the slope time of the trigger signal (positive pulse width, negative pulse width) is less than the set slope time, the upper limit of time can be set.
- c. \leq : When the slope time of the trigger signal (positive pulse width, negative pulse width) is the same as the set slope time or triggered within the set slope time, the lower and upper limit of time can be set.

Note: The slope time of the trigger signal refers to both the **slope time of the rising edge** and the **slope time of the falling edge**, as illustrated in the figure below.

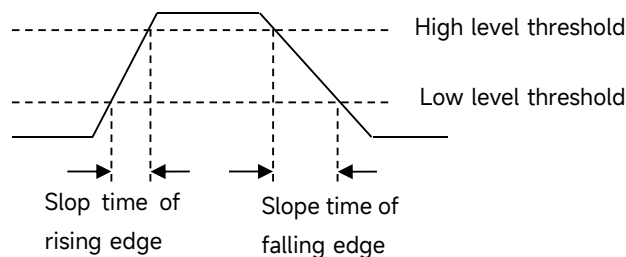

(6) High/Low Level

The slope trigger requires the high level and low level to be set. The slope trigger can only be stable generated when all conditions are met.

Tap to select “High Level” or “Low Level”, the high level and low level can be changed by using the [Multipurpose A](#) or the numeric keypad on the front panel or pressing the trigger level [Position](#) rotary knob on the right side of the front panel to switch the selected level. The selected level is displayed as in solid line. For more details on *Trigger Level*, refer to the section [Noun Explanation of Triggering System](#).

Correlation: Tick the correlation, i.e. if one level changes, the other will also change.

(7) Lower/Upper Limit of Time

- When the trigger condition is “>” or “<”, click on the input field of the lower limit or the upper limit to open the numeric keypad to set the lower or upper limit of time. Alternatively, rotate the Multipurpose A rotary knob on the front panel to adjust the lower or upper limit of time.
- When the trigger condition is “≤≥”, click on the input field of the lower limit or the upper limit to open the numeric keypad to set the lower or upper limit of time. Alternatively, rotate the Multipurpose A rotary knob on the front panel to adjust the lower or upper limit of time, the lower limit of time must be less than or equal to the upper limit of time. The time range can be set from 3.2 ns to 1 s.

Note: The set slew rate is displayed at the bottom left of the screen.

The formula for calculating the slew rate: **(High level threshold - low level threshold) ÷ Time**

In this formula, "Time" refers to the set slope time.

8.6. Runt Pulse Triggering

The runt pulse triggering is used to trigger a pulse that has crossed one trigger level but not the other.

In this oscilloscope, the positive runt pulse is the pulse that crosses the lower limit of the trigger level but does not cross the upper limit of the trigger level; the negative runt pulse is the pulse that crosses the upper limit of the trigger level but does not cross the lower limit of the trigger level, as shown in the following figure.

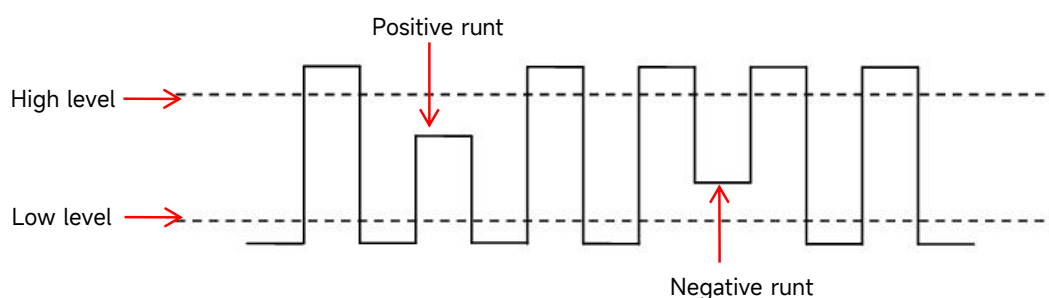

The runt trigger menu can set the source, trigger mode, polarity (positive, negative), runt condition (irrelevance, <, >, ≤≥), the lower/upper limit of time, and high/low level.

(1) Trigger Type

Press the Menu softkey on the front panel or tap the **T** trigger label on the top to open the “Trigger” menu. Tap “Trigger Type” to open the dropdown menu, then select “Runt Trigger” to configure the trigger settings.

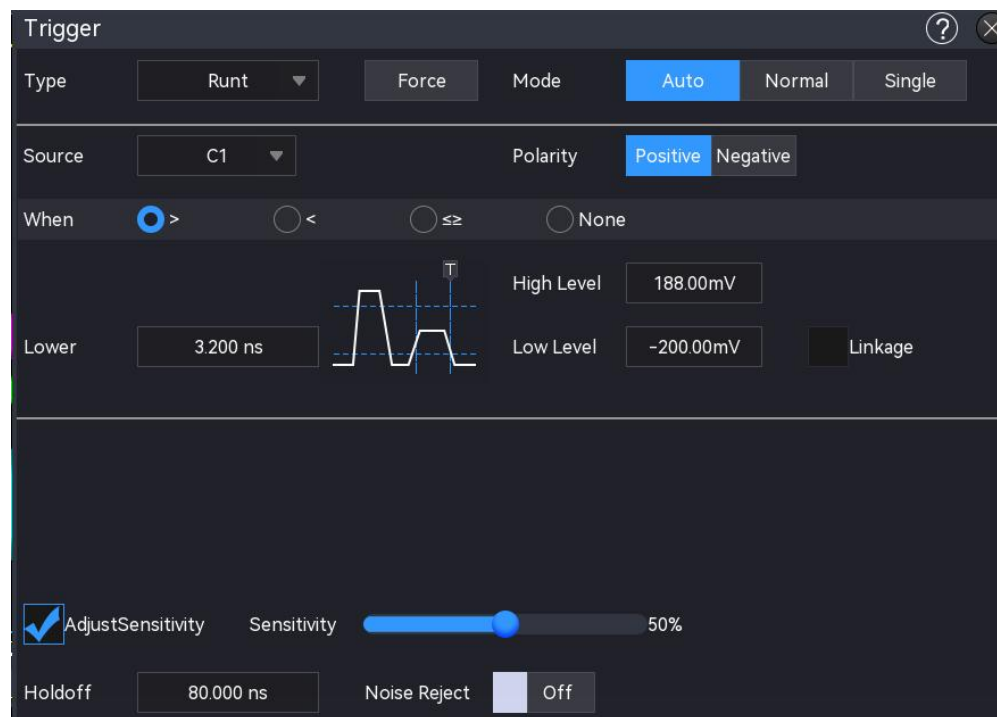

(2) Trigger Mode

Set the trigger mode to auto, normal, or single. For more details on *Trigger Mode*, refer to the section [Noun Explanation of Triggering System](#).

(3) Source

Click on the “Source” to select C1-C4. For more details on *Trigger Source*, refer to the section [Noun Explanation of Triggering System](#). The current source is displayed in the trigger label at the top of the screen.

The source can only trigger stably if the selected channel has a connected signal and is set as the trigger source.

(4) Polarity

- a. Positive: Triggered on the positive runt pulse.
- b. Negative: Triggered on the negative runt pulse.

(5) Runt Condition

- a. >: When the runt pulse width is greater than the lower limit of the set pulse width, the lower limit of time can be set.
- b. <: When the runt pulse width is less than the upper limit of the set pulse width, the upper limit of time can be set.
- c. ≤≥: When the runt pulse width is equal to the lower or upper limit of time, the upper and lower limit of time can be set at the same time.
- d. Irrelevance: The runt pulse width is not compared to the time.

(6) High/Low Level

The runt plus trigger requires the high level and low level to be set. The runt plus trigger can only be stable generated when all conditions are met.

Tap to select “High Level” or “Low Level”, the high level and low level can be changed by using the [Multipurpose A](#) or the numeric keypad on the front panel. For more details on *Trigger Level*, refer to the section [Noun Explanation of Triggering System](#).

Correlation: Tick the correlation, i.e. if one level changes, the other will also change.

(7) Lower/Upper Limit of Time

- When the trigger condition is “>” or “<”, click on the input field of the lower limit or the upper limit to open the numeric keypad to set the lower or upper limit of time. Alternatively, rotate the [Multipurpose A](#) rotary knob on the front panel to adjust the lower or upper limit of time.
- When the trigger condition is “ \leq ” or “ \geq ”, click on the input field of the lower limit or the upper limit to open the numeric keypad to set the lower or upper limit of time. Alternatively, rotate the [Multipurpose A](#) rotary knob on the front panel to adjust the lower or upper limit of time, the lower limit of time must be less than or equal to the upper limit of time. The time range can be set from 3.2 ns to 10 s.

8.7. Over-amplitude Pulse Triggering

The over-amplitude pulse trigger has both a high level and a low level. The oscilloscope will trigger when the rising edge of the input signal crosses the high level or the falling edge crosses the low level, as shown in the following figure.

The over-amplitude pulse trigger menu can set the source, trigger mode, over-amplitude type (rising edge, falling edge, and arbitrary edge), trigger position (enter, exit, and time), over-amplitude time, and high/low level.

(1) Trigger Type

Press the Menu softkey on the front panel or tap the **T** trigger label on the top to open the “Trigger” menu. Tap “Trigger Type” to open the dropdown menu, then select “Over-amplitude Pulse Trigger” to configure the trigger settings.

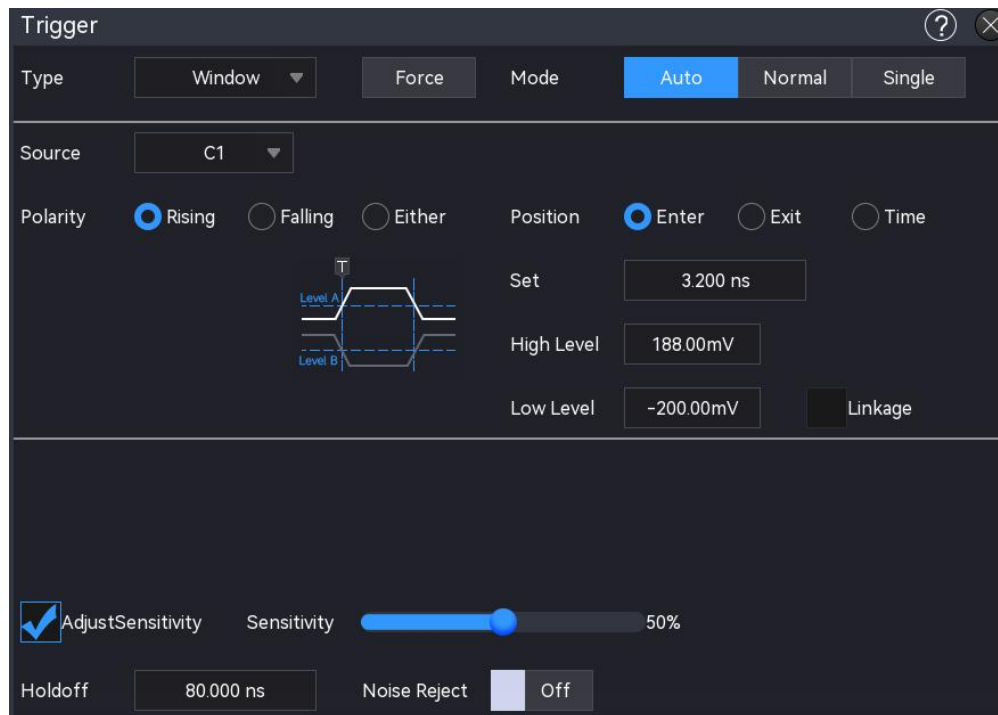

(2) Trigger Mode

Set the trigger mode to auto, normal, or single. For more details on *Trigger Mode*, refer to the section [Noun Explanation of Triggering System](#).

(3) Source

Click on the “Source” to select C1-C4. For more details on *Trigger Source*, refer to the section [Noun Explanation of Triggering System](#). The current source is displayed in the trigger label at the top of the screen.

The source can only trigger stably if the selected channel has a connected signal and is set as the trigger source.

(4) Over-amplitude Type

Set the input signal to trigger on the specified edge type, which can be rising, falling, or arbitrary edge. The current over-amplitude type is displayed in the top right corner of the screen.

- a. Rising edge: Triggered on the rising edge of the input signal when the voltage level exceeds the set high level.
- b. Falling edge: Triggered on the falling edge of the input signal when the voltage level falls below the set low level.
- c. Arbitrary edge: Triggered on any edge of the input signal when the voltage level meets the set high or low level.

(5) Trigger Position

The trigger position can be set to enter, exit, or time. It is helpful to further confirm the trigger time.

- a. Enter: Triggered when the input signal crosses the specified trigger level.
- b. Exit: Triggered when the input signal crosses out of the specified trigger level.
- c. Time: Triggered when the accumulated hold time of the over-amplitude exceeds or equals the preset over-amplitude time.

(6) Over-amplitude Time

If the trigger position is “Time” and the over-amplitude time is available, the oscilloscope will be generated when the condition is met. Click on the “Over-amplitude” input field to open the numeric keypad to set the over-amplitude time. Alternatively, rotate the Multipurpose A rotary knob on the front panel to set the over-amplitude time.

The over-amplitude time can be set from 3.2 ns to 10 s.

(7) High/Low Level

The over-amplitude trigger requires the high level and low level to be set. The over-amplitude trigger can only be stably generated when all conditions are met.

Tap to select “High Level” or “Low Level”, the high level and low level can be changed by using the Multipurpose A or the numeric keypad on the front panel. For more details on *Trigger Level*, refer to the section [Noun Explanation of Triggering System](#).

Correlation: Tick the correlation, i.e. if one level changes, the other will also change.

8.8. Delay Triggering

Delay triggering requires the trigger source 1 and trigger source 2 to be set. When the time difference (ΔT) between the edge set by source 1 (edge 1) and the edge set by source 2 (edge 2) meets the preset time limit, the oscilloscope will be triggered, as shown in the following figure.

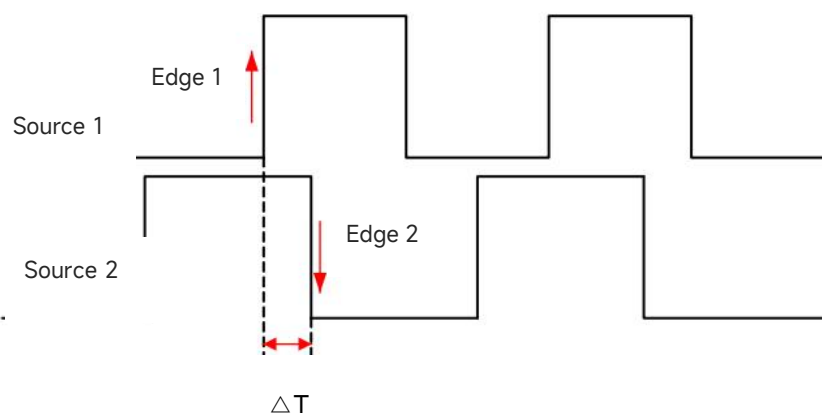

Edge 1 is set as the rising edge. Edge 2 is set as the falling edge. ΔT is the area marked in red.

Note: Edge 1 and edge 2 must be adjacent edges.

Note: Only the channel that has a connected signal and to be the trigger source can be triggered stably.

(1) Trigger Type

Press the **Menu** softkey on the front panel or tap the **T** trigger label on the top to open the “Trigger” menu. Tap “Trigger Type” to open the dropdown menu, then select “Delay Trigger” to configure the trigger settings.

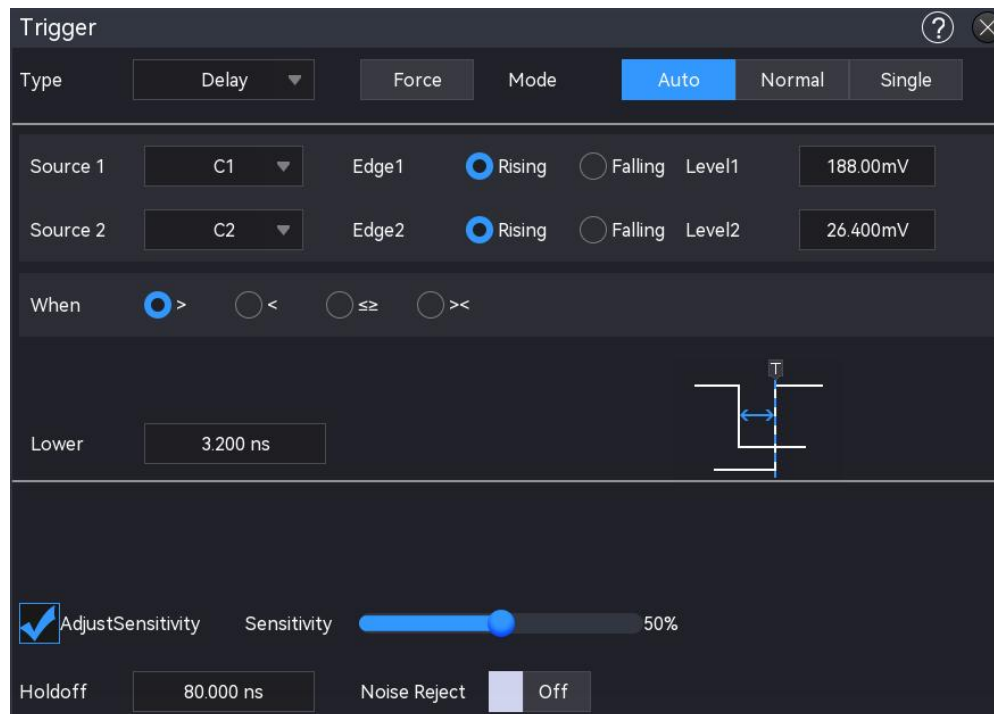

(2) Trigger Mode

Set the trigger mode to auto, normal, or single. For more details on *Trigger Mode*, refer to the section [Noun Explanation of Triggering System](#).

(3) Source 1

Click on the “Source 1” to select C1-C4 or D0-D15. For more details on *Trigger Source*, refer to the section [Noun Explanation of Triggering System](#). The current source is displayed in the trigger label at the top of the screen.

The source can only trigger stably if the selected channel has a connected signal and is set as the trigger source.

(4) Edge 1

Click on the “Edge 1” to set the delay trigger for “Source 1”, it can be set to rising or falling edge.

(5) Source 2

Click on the “Source 2” to select C1-C4 or D0-D15. For more details on *Trigger Source*, refer to

the section [Noun Explanation of Triggering System](#). The current source is displayed in the trigger label at the top of the screen.

The source can only trigger stably if the selected channel has a connected signal and is set as the trigger source.

(6) Edge 2

Click on the “Edge 2” to set the delay trigger for “Source 2”, it can be set to rising or falling edge.

(7) Delay Condition

- a. $>$: The oscilloscope will be generated when the time difference (ΔT) between the edge of source 1 and the edge of source 2 is greater than the set lower limit of time, and the lower limit of time can be set.
- b. $<$: The oscilloscope will be generated when the time difference (ΔT) between the edge of source 1 and the edge of source 2 is greater than the set upper limit of time, and the upper limit of time can be set.
- c. $\leq\geq$: The oscilloscope will be generated when the time difference (ΔT) between the edge of source 1 and the edge of source 2 is greater than or equal to the set lower limit of time and less than or equal to the set upper limit of time, and the upper/lower limit of time can be set.
- d. $> <$: The oscilloscope will be generated when the time difference (ΔT) between the edge of source 1 and the edge of source 2 is less than the set lower limit of time or greater than the set upper limit of time, and the upper/lower limit of time can be set.

(8) Lower/Upper Limit of Time

- When the trigger condition is “ $>$ ” or “ $<$ ”, click on the input field of the lower limit or the upper limit to open the numeric keypad to set the lower or upper limit of time. Alternatively, rotate the [Multipurpose A](#) rotary knob on the front panel to adjust the lower or upper limit of time.
- When the trigger condition is “ $\leq\geq$ ”, click on the input field of the lower limit or the upper limit to open the numeric keypad to set the lower or upper limit of time. Alternatively, rotate the [Multipurpose A](#) rotary knob on the front panel to adjust the lower or upper limit of time, the lower limit of time must be less than or equal to the upper limit of time. The time range can be set from 3.2 ns to 10 s.

(9) Level 1, Low-level 2

The delay trigger requires both trigger source 1 and trigger source 2 to be set. It will only be generated when all conditions are met. The level can be adjusted using the [Multipurpose A](#) rotary knob or the numeric keypad on the front panel. For more details on *Trigger Level*, refer to the section [Noun Explanation of Triggering System](#).

8.9. Timeout Triggering

The oscilloscope will be triggered when the time interval (ΔT) from the rising edge (or falling edge) of the input signal across the trigger level and to the adjacent falling edge (rising edge) across the trigger level is greater than the set timeout time, as shown in the following figure.

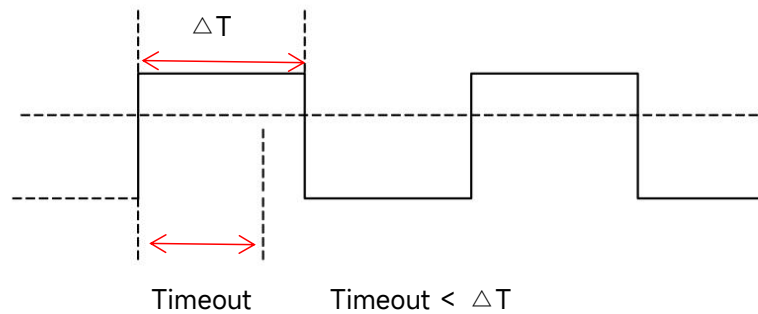

(1) Trigger Type

Press the **Menu** softkey on the front panel or tap the **T** trigger label on the top to open the “Trigger” menu. Tap “Trigger Type” to open the dropdown menu, then select “Timeout Trigger” to configure the trigger settings.

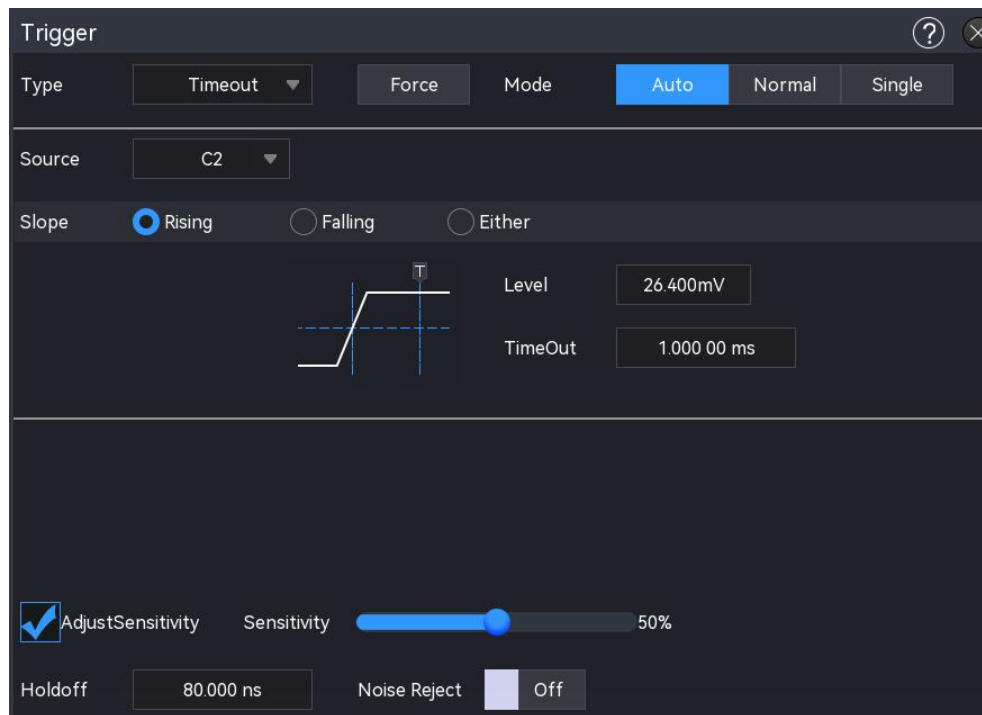

(2) Trigger Mode

Set the trigger mode to auto, normal, or single. For more details on *Trigger Mode*, refer to the section [Noun Explanation of Triggering System](#).

(3) Source

Click on the “Source” to select C1-C4 or D0-D15. For more details on *Trigger Source*, refer to

the section [Noun Explanation of Triggering System](#). The current source is displayed in the trigger label at the top of the screen.

The source can only trigger stably if the selected channel has a connected signal and is set as the trigger source.

(4) Edge Type

Select the edge type on which the input signal will trigger. The current edge type is displayed in the trigger label at the top of the screen.

- a. Rising edge: Counts the time when the rising edge of the input signal crosses the trigger level.
- b. Falling edge: Counts the time when the falling edge of the input signal crosses the trigger level.
- c. Arbitrary edge: Counts the time when either the rising or falling edge of the input signal crosses the trigger level.

(5) Timeout

Timeout is used to set the maximum hold time after the input signal across the trigger level. The oscilloscope will be generated when $\text{timeout} < \Delta T$. Click on the "Timeout" input field to open the numeric keypad to set the timeout. Alternatively, rotate the [Multipurpose A](#) rotary knob on the front panel to adjust the timeout.

The timeout range can be set from 3.2 ns to 10 s.

(6) Level

Tap to select "Level", the trigger level can be changed by using the [Multipurpose A](#), trigger [Position](#) rotary knob, and the numeric keypad on the front panel. For more details on *Trigger Level*, refer to the section [Noun Explanation of Triggering System](#).

8.10. Duration Triggering

When the duration triggering is selected, the oscilloscope identifies the trigger condition by looking for the duration of the specified codes. The code pattern is the combination of channel logic "AND", and the value of each channel can be H (high), L (low), or X (ignore). The oscilloscope will be generated when the duration (ΔT) of the code pattern meets a preset time, as shown in the following figure.

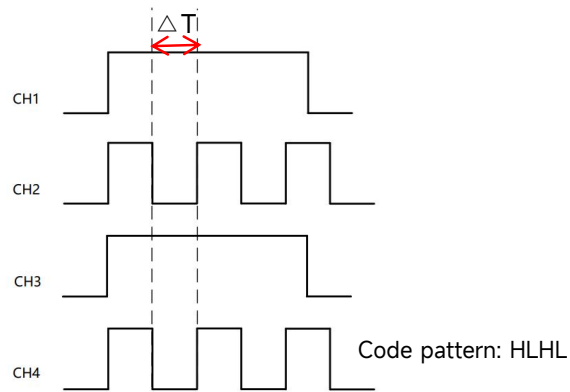

(1) Trigger Type

Press the **Menu** softkey on the front panel or tap the **T** trigger label on the top to open the “Trigger” menu. Tap “Trigger Type” to open the dropdown menu, then select “Duration Trigger” to configure the trigger settings.

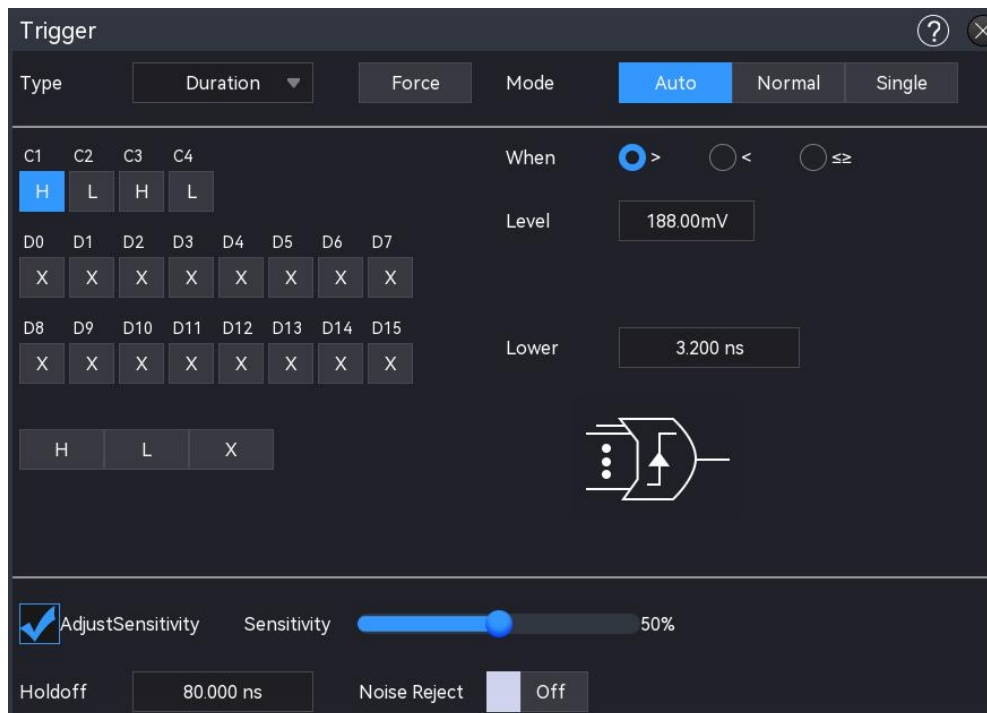

(2) Trigger Mode

Set the trigger mode to auto, normal, or single. For more details on *Trigger Mode*, refer to the section [Noun Explanation of Triggering System](#).

(3) Source

Click on the “Source” to select C1-C4 or D0-D15. For more details on *Trigger Source*, refer to the section [Noun Explanation of Triggering System](#). The current source is displayed in the trigger label at the top of the screen.

The source can only trigger stably if the selected channel has a connected signal and is set as

the trigger source.

(4) Code Pattern

The code pattern can be set to H, L, or X. The code pattern for each channel is displayed at the bottom of the screen, as shown in the figure above.

- a. H: Set the code pattern for the selected channel to “High”, i.e. the voltage level is higher than the trigger level of the channel.
- b. L: Set the code pattern for the selected channel to “Low”, i.e. the voltage level is lower than the trigger level of the channel.
- c. X: Set the code pattern for the selected channel to “X”, i.e. the channel is not part of the code pattern, the oscilloscope will not be triggered if all channel in the code pattern is set to “X”.

(5) Trigger Condition

- a. $>$: The oscilloscope will be generated when the duration is greater than the set lower limit of time, and the lower limit of time can be set.
- b. $<$: The oscilloscope will be generated when the duration is less than the set upper limit of time, and the upper limit of time can be set.
- c. $\leq\geq$: The oscilloscope will be generated when the duration is less than or equal to the set upper limit of time and greater than or equal to the lower limit of time, and the upper/lower limit of time can be set.

(6) Lower/Upper Limit of Time

- When the trigger condition is “ $>$ ” or “ $<$ ”, click on the input field of the lower limit or the upper limit to open the numeric keypad to set the lower or upper limit of time. Alternatively, rotate the Multipurpose A rotary knob on the front panel to adjust the lower or upper limit of time.
- When the trigger condition is “ $\leq\geq$ ”, click on the input field of the lower limit or the upper limit to open the numeric keypad to set the lower or upper limit of time. Alternatively, rotate the Multipurpose A rotary knob on the front panel to adjust the lower or upper limit of time, the lower limit of time must be less than or equal to the upper limit of time. The time range can be set from 3.2 ns to 10 s.

(7) Level

Tap to select “Level”, the trigger level can be changed by using the Multipurpose A, trigger Position rotary knob, and the numeric keypad on the front panel. For more details on *Trigger Level*, refer to the section [Noun Explanation of Triggering System](#).

8.11. Setup & Hold Triggering

The setup/hold triggering requires the data signal line and clock signal line to be set. The setup time begins when the data signal crosses the trigger level and ends when the specified clock edge arrives. The hold time begins when the specified clock edge arrives and ends when the data signal crosses the trigger level again (as shown in the following figure). The oscilloscope will be triggered when the setup time or the hold time is less than the pre-set time. It is mainly used to locate and find the error code, and quickly find the signal that cannot meet setup and hold time.

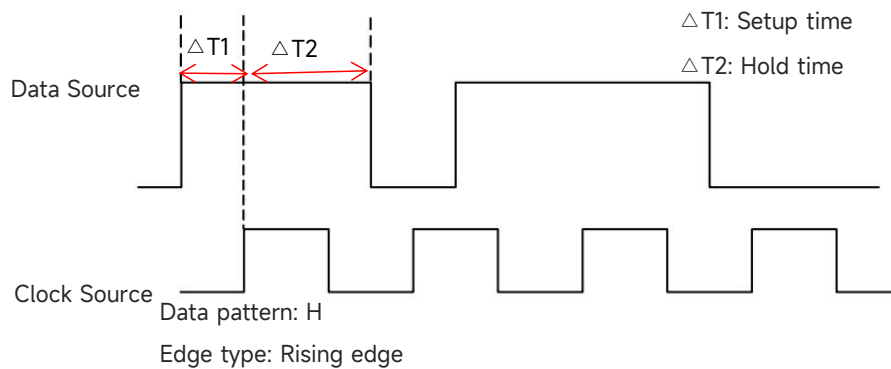

(1) Trigger Type

Press the **Menu** softkey on the front panel or tap the **T** trigger label on the top to open the “Trigger” menu. Tap “Trigger Type” to open the dropdown menu, then select “Setup & Hold” to configure the trigger settings.

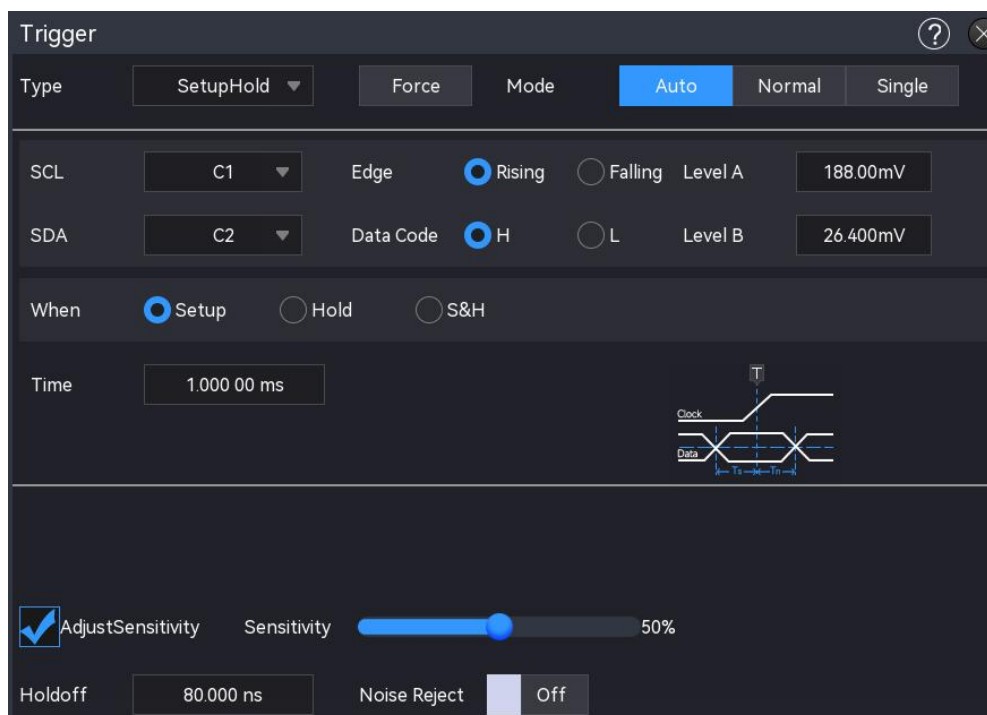

(2) Trigger Mode

Set the trigger mode to auto, normal, or single. For more details on *Trigger Mode*, refer to the section [Noun Explanation of Triggering System](#).

(3) Data Source

Click on the “Data Source” to select C1-C4 or D0-D15. For more details on *Trigger Source*, refer to the section [Noun Explanation of Triggering System](#). The current source is displayed in the trigger label at the top of the screen.

The source can only trigger stably if the selected channel has a connected signal and is set as the trigger source.

(4) Data Type

Select the valid code pattern for the data signal. It can be set to H or L.

- a. H: Sets the valid code pattern for the data signal to a high level.
- b. L: Sets the valid code pattern for the data signal to a low level.

(5) Clock Source

Click on the “Clock Source” to select C1-C4. For more details on *Trigger Source*, refer to the section [Noun Explanation of Triggering System](#). The current source is displayed in the trigger label at the top of the screen.

The source can only trigger stably if the selected channel has a connected signal and is set as the trigger source.

(6) Edge Type

- a. Rising edge: Sets the clock edge to the rising edge.
- b. Falling edge: Sets the clock edge to the falling edge.

(7) Trigger Condition

- a. Setup: The oscilloscope will be generated when the setup time is less than the set time.
- b. Hold: The oscilloscope will be generated when the hold time is less than the set time.
- c. Setup & Hold: The oscilloscope will be generated when the setup and hold time is less than the set time.

(8) Time

The setup and hold time ΔT is compared to the set time, the oscilloscope will be generated when the condition is met. Click on the “Time” input field to open the numeric keypad to set the time. Alternatively, rotate the [Multipurpose A](#) and the numeric keypad on the front panel to adjust the time.

The time range can be set from 3.2 ns to 10 s.

(9) Data Level, Clock Level

The setup & hold trigger requires the data level, clock level to be set. The setup & hold trigger

can only be stable generated when all conditions are met.

Tap to select “Data Level” or “Clock Level”, the data level and clock level can be changed by using the [Multipurpose A](#) or the numeric keypad on the front panel. For more details on *Trigger Level*, refer to the section [Noun Explanation of Triggering System](#).

8.12. Nth Edge Triggering

The Nth edge triggering refers to be triggered on the Nth edge after the specified idle time. For example, waveform as shown in the following figure, it is set to trigger on the 2nd rising edge after the specified idle time (the time between two adjacent rising edges), then set the idle time as $P < \text{idle time} < M$, M is the time between the 1st rising edge and the next rising edge, P is the maximum time between the counting rising edge, as shown in the following figure.

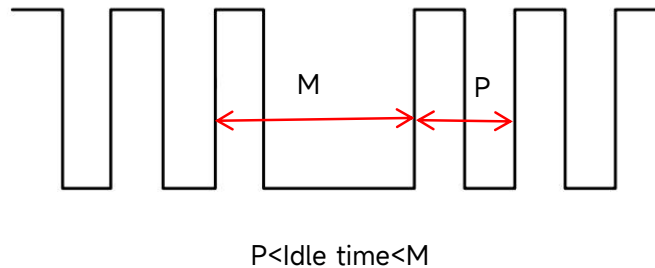

(1) Trigger Type

Press the Menu softkey on the front panel or tap the **T** trigger label on the top to open the “Trigger” menu. Tap “Trigger Type” to open the dropdown menu, then select “Nth Edge Trigger” to configure the trigger settings.

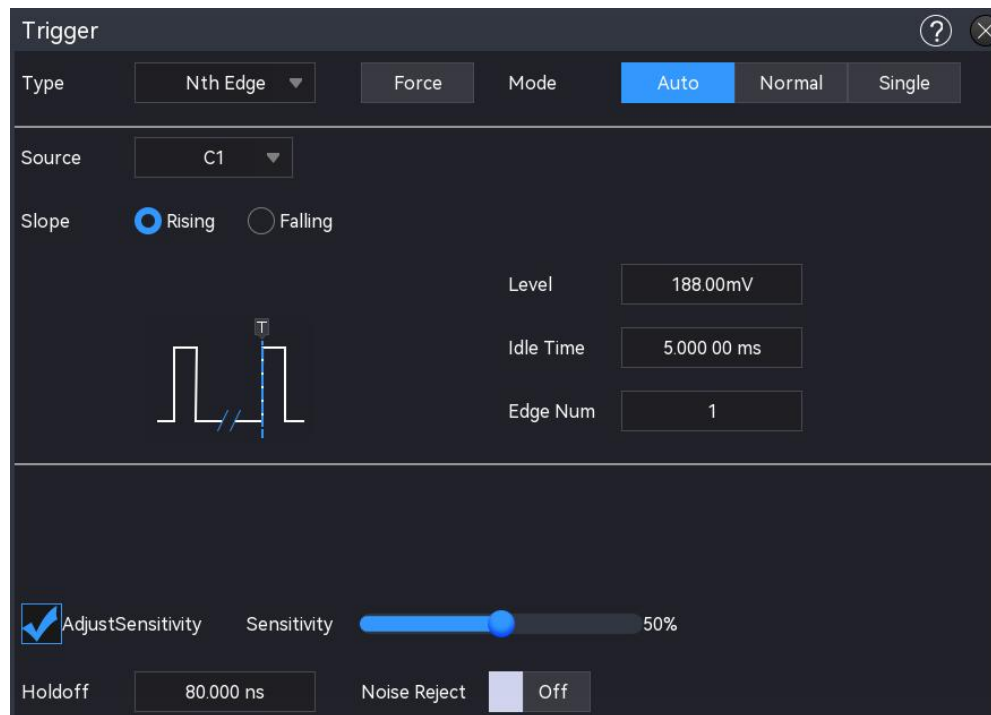

(2) Trigger Mode

Set the trigger mode to auto, normal, or single. For more details on *Trigger Mode*, refer to the section [Noun Explanation of Triggering System](#).

(3) Source

Click on the “Source” to select C1-C4 or D0-D15. For more details on *Trigger Source*, refer to the section [Noun Explanation of Triggering System](#). The current source is displayed in the trigger label at the top of the screen.

The source can only trigger stably if the selected channel has a connected signal and is set as the trigger source.

(4) Edge Type

Select an input signal to trigger on which edge.

- a. Rising edge: Set a signal to trigger on the rising edge.
- b. Falling edge: Set a signal to trigger on the falling edge.

(5) Idle Time

The idle time is compared to pulse time, the oscilloscope will be generated when the condition is met. Click the “Idle Time” input field to open the numeric keypad to set the idle time.

Alternatively, rotate the [Multipurpose A](#) rotary knob on the front panel to adjust the idle time.

The idle time range can be set from 3.2 ns to 10 s.

(6) Edge Number

The edge number represents Nth edge value. Click on the “Edge Number” input field to open

the numeric keypad to set the edge number. Alternatively, rotate the Multipurpose A rotary knob on the front panel to adjust the edge number. The edge number range can be set from 1 to 65535.

(7) Level

Tap to select “Level”, the trigger level can be changed by using the Multipurpose A, trigger Position rotary knob, and the numeric keypad on the front panel. For more details on *Trigger Level*, refer to the section [Noun Explanation of Triggering System](#).

8.13. Code Pattern Triggering

The code pattern triggering identifies the trigger condition by detecting specified patterns. The pattern trigger type uses a logical AND combination of the channel settings, where each channel can be set to H (high), L (low), or X (omitted). Additionally, you can specify a rising edge or falling edge for one channel (only one edge can be specified).

When an edge is assigned, the oscilloscope will trigger on the specified edge if the pattern of the other channels meets the preset pattern type (i.e., if the actual pattern matches the preset pattern). If no edge is assigned, the oscilloscope will trigger on the last edge where the pattern was “true”. If all channels are set to X (ignored), the oscilloscope will not trigger.

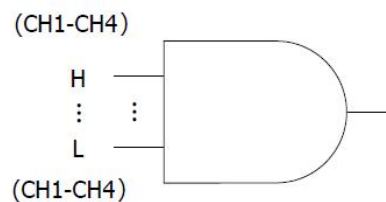

(1) Trigger Type

Press the Menu softkey on the front panel or tap the **T** trigger label on the top to open the “Trigger” menu. Tap “Trigger Type” to open the dropdown menu, then select “Code Pattern” to configure the trigger settings.

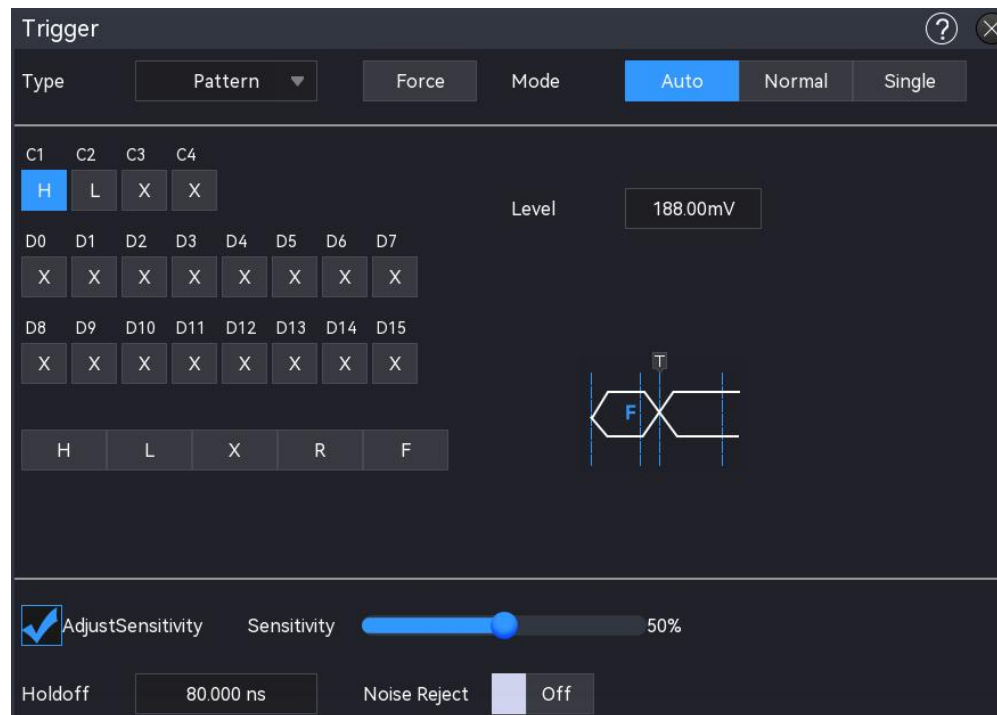

(2) Trigger Mode

Set the trigger mode to auto, normal, or single. For more details on *Trigger Mode*, refer to the section [Noun Explanation of Triggering System](#).

(3) Source

Click on the “Source” to select C1-C4 or D0-D15. For more details on *Trigger Source*, refer to the section [Noun Explanation of Triggering System](#). The current source is displayed in the trigger label at the top of the screen.

The source can only trigger stably if the selected channel has a connected signal and is set as the trigger source.

(4) Code Pattern

The code pattern can be set to H, L, X, rising edge, or falling edge. The current code pattern is displayed in the top right corner.

- a. H: Set the code pattern for the selected channel to “H”, i.e. the voltage level is higher than the trigger level of the channel.
- b. L: Set the code pattern for the selected channel to “Low”, i.e. the voltage level is lower than the trigger level of the channel.
- c. X: Set the code pattern for the selected channel to “X”, i.e. the channel is not part of the code pattern, the oscilloscope will not be triggered if all channel in the code pattern is set to “X”.
- d. Rising edge: Set the code pattern for the selected channel to the rising edge.
- e. Falling edge: Set the code pattern for the selected channel to the falling edge.

(5) Level

Tap to select “Level”, the trigger level can be changed by using the [Multipurpose A](#), trigger [Position](#) rotary knob, and the numeric keypad on the front panel. For more details on *Trigger Level*, refer to the section [Noun Explanation of Triggering System](#).

8.14. RS232 Triggering

RS232 bus triggering is a serial communication method for transferring data between computers or between a computer and a terminal.

(1) Trigger Type

Press the [Menu](#) softkey on the front panel or tap the **T** trigger label on the top to open the “Trigger” menu. Tap “Trigger Type” to open the dropdown menu, then select “RS232 Trigger” to configure the trigger settings.

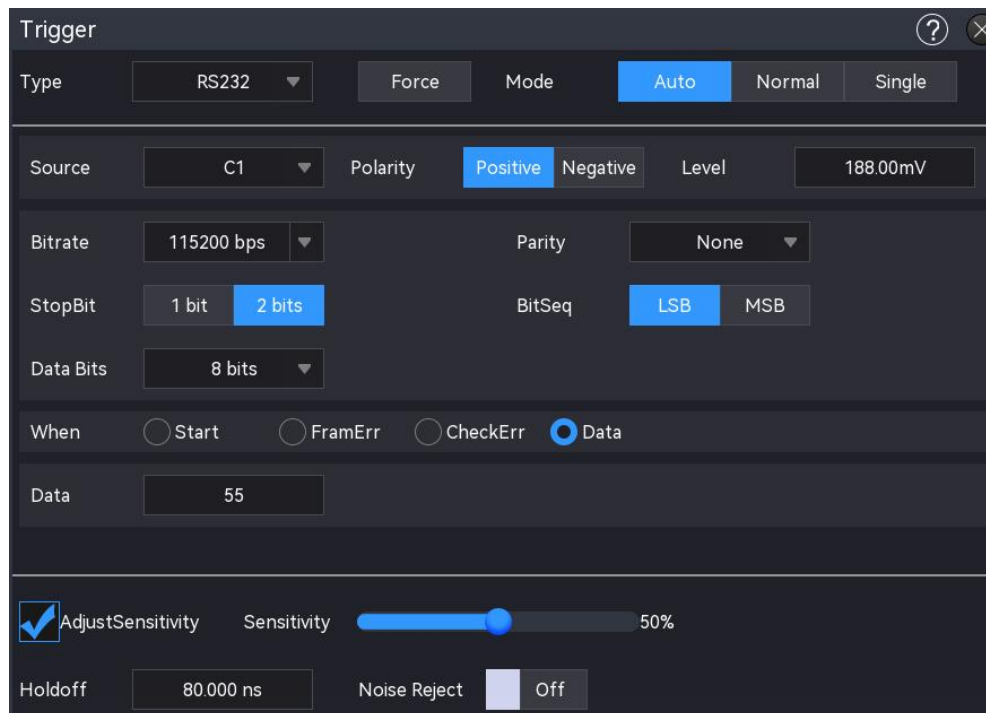

(2) Source

Click on the “Source” to select C1-C4 or D0-D15. For more details on *Trigger Source*, refer to the section [Noun Explanation of Triggering System](#). The current source is displayed in the trigger label at the top of the screen.

The source can only trigger stably if the selected channel has a connected signal and is set as the trigger source.

(3) Level

Double-click on the “Level” input field to open the numeric keypad to set the trigger level;

rotate the Multipurpose A rotary knob or rotate the trigger Position rotary knob on the right side of the front panel to adjust the trigger level.

When the trigger level is changed, a dotted line appears on the screen indicating the current trigger level. Once the change is stopped, the dotted line of the trigger level disappears after about 2 seconds.

(4) Polarity

- a. Negative: The reversed polarity of logic level, i.e. the high level is 0 and the low level is 1.
- b. Positive: The normal polarity of logic level, i.e. the high level is 1 and the low level is 0.

(5) Parity Check

Set the Parity check for data transmission. Click on the "Parity Check" to select none, even parity check, or odd parity check.

(6) Data Bit Width

Set the data bit width for RS232 signal, click on the "Data Bit" to select 5 bits, 6 bits, 7 bits, or 8 bits.

(7) Bit Sequence

Set the data bit sequence for RS232 signal, click on the "Bit Sequence" to select MSB or LSB

- a. MSB: The Most Significant Bit, i.e., the bit with the highest value in a sequence, transmitted first.
- b. LSB: The Least Significant Bit, i.e., the bit with the lowest value in a sequence, transmitted last.

(8) Stop Bit

Set the stop bit for each data, click on the "Stop Bit" to select 1 bit or 2 bits.

(9) Btrate

When RS232 communication is asynchronous transmission communication, no accompanying clock signal during the data transmission process, to solve the determination of data bits, the protocol requires that the two sides of communication to agree on the bit rate. Generally, the bit rate is defined as the number of bits that can be transmitted for 1 s time, for example, 9600 bps means that 9600 bits can be transmitted for 1 s. The bitrate is not directly equal to the effective data transmission rate. Note that the start bit, data bit, checksum and stop bit are all counted as bit bits, so the bitrate is not directly equal to the effective data rate. The oscilloscope will set the bitrate according to the bitrate form bit sampling.

Bitrate can be set to 2400 bps, 4800 bps, 9600 bps, 19200 bps, 38400 bps, 57600 bps, 115200 bps, or custom. Open the numeric keypad to set the custom bitrate.

It is recommended to make reasonable settings according to your RS232 communication hardware and software. Due to the basic model of this transmission protocol, RS232 protocol is

usually used in short distance (less than 20 m), low speed (less than 1 Mbps) transmission occasions, and the communication outside of this range is susceptible to interference and becomes unreliable.

(10) Trigger Condition

- a. Start frame: The oscilloscope will trigger on the start bit of RS232. When sending a single string or sending the same string several times, this trigger can be used to see a stable signal waveform, and if the sent data changes, the corresponding waveform will also be changed.
- b. Frame error: A 0 occurs in the stop state or a data error occurs in the middle of the data bit when receiving.
- c. Parity error: When RS232 has the parity bit, set the parity bit to 0 or 1 according to the parity check method.

The parity checking rules are as follows:

- Odd parity check: The transmission is considered correct if the number of 1s in both the data bits and the parity bit is odd.
- Even parity check: The transmission is considered correct if the total number of 1s in both the data bits and the parity bit is even.

With this setting, the user can quickly locate and find the transmission process of parity error during the RS232 communication. It is useful for analyzing the fault.

- d. Data: The trigger will be generated when data acquired by the oscilloscope is the same as the custom 2 bits in hexadecimal. With this option, the user can quickly find the transmission signal that the specific data they are interested in.

When the data is selected, the data menu can be configured.

- Data: The data is related to the frame length, double-click on the "Data" input field to open the numeric keypad to set the data. For details on the use of the numeric keypad, refer to the section of [5.8 Parameter Setting](#). Alternatively, select the parameter, use the [Multipurpose B](#) rotary knob to move the cursor, and use the [Multipurpose A](#) rotary knob to adjust the data value. The data range can be set from 00 to FF.

8.15. I²C Triggering

I²C bus triggering is a two-wire serial bus and used to connect the microcontroller and peripheral device. It's widely applied in micro-electronics area.

(1) Trigger Type

Press the softkey on the front panel or tap the **T** trigger label on the top to open the

“Trigger” menu. Tap “Trigger Type” to open the dropdown menu, then select “I²C Trigger” to configure the trigger settings.

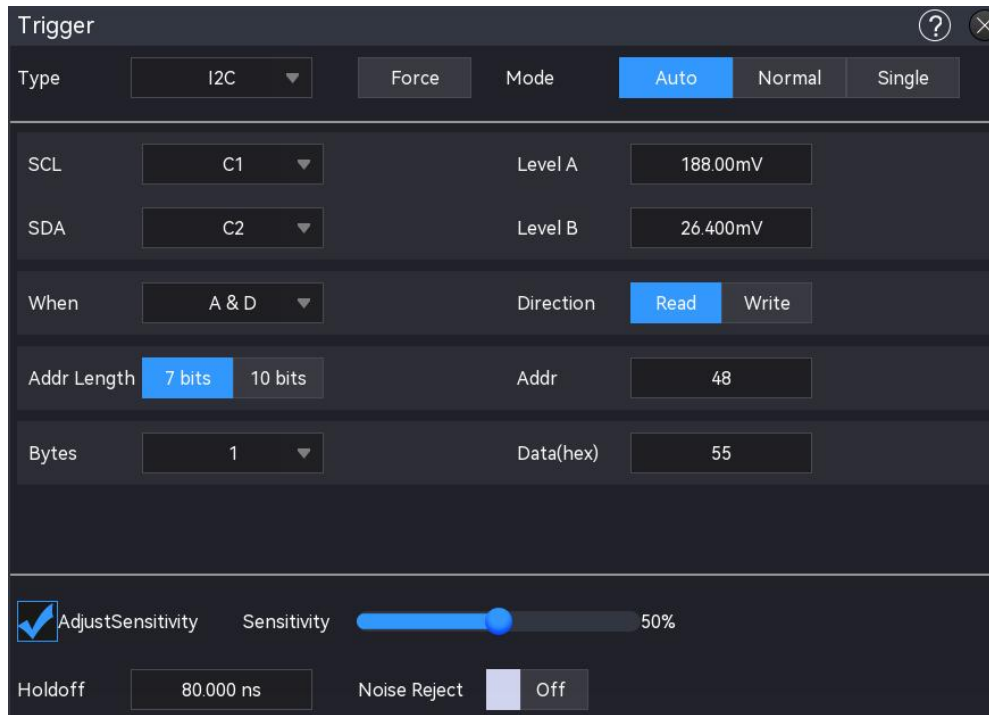

(2) Source Setting

Set both the clock source and the data source. The oscilloscope will only trigger stably if the selected channel has a connected signal and is set as the trigger source.

a. Clock Source

Click on the “Clock Source” to select C1-C4 or D0-D15. For more details on *Trigger Source*, refer to the section [Noun Explanation of Triggering System](#). The current source is displayed in the trigger label at the top of the screen.

The source can only trigger stably if the selected channel has a connected signal and is set as the trigger source.

b. Data Source

Click on the “Data Source” to select C1-C4 or D0-D15. For more details on *Trigger Source*, refer to the section [Noun Explanation of Triggering System](#). The current source is displayed in the trigger label at the top of the screen.

The source can only trigger stably if the selected channel has a connected signal and is set as the trigger source.

(3) Level Setting

Click on the “Level A, Level B”, and double-click on “Level” input field to open the numeric keypad to set the trigger level. Alternatively, rotate the [Multipurpose A](#) rotary knob to adjust the trigger level, or press the trigger [Position](#) rotary knob on the right side of the front panel to

switch the selected trigger level (the selected threshold is displayed in full line) and then rotate rotary knob to change the trigger level.

(4) Operating Direction

Click on the "Operating Direction" to select "Read" or "Write".

- a. Write: The oscilloscope will be generated when I²C protocol "Read/write" bit is set to "Write".
- b. Read: The oscilloscope will be generated when I²C protocol "Read/write" bit is set to "Read".

(5) Trigger Condition

- a. Start: Triggered on the start time.
- b. Restart: Triggered on the restart time, i.e. a start signal appears again after a start signal has appeared, but a stop has not appeared yet.
- c. Stop: Triggered on the stop bit, i.e. SDA signal goes from low to high when SCL is at the high level.
- d. Loss confirmed: In I²C protocol, every time after 8 bits information is transmitted, the data receiver needs to send an acknowledgement signal, which is the ACK bit in the above figure when the SCL is in the high level and the SDA signal is low. The loss trigger will occur while the SCL and SDA signal at the ACK bit are both high.
- e. Address: The oscilloscope will be generated when the communication address is the same with the user setting address. It can help the user to quickly locate the address transmission.

When the address length or address is selected, the corresponding menus can be configured.

- Address length: Set the address bit width of I²C signal, click on the "Address Length" to select 7 bits or 10 bits.
 - Address: Set the trigger address, double-click on the "Address" input field to open the numeric keypad to set the address. For details on the use of the numeric keypad, refer to the section of [5.8 Parameter Setting](#). Alternatively, select the parameter, use the [Multipurpose B](#) rotary knob to move the cursor, and use the [Multipurpose A](#) rotary knob to adjust the data value. The data range can be set from 00 to 7F and from 000 to 3FF.
- f. Data: The waveform will be generated when the data acquired by I²C is the same as the custom data. It can help the user to quickly find the transmission signal that the specific data they are interested in.

When the byte length or data is selected, the corresponding menus can be configured.

- Byte length: Click on the "Byte Length" input field to set the byte length for the specified data. The byte length range can be set from 1 to 5.
- Data: The data is related to the frame length, double-click on the "Data" input field to

open the numeric keypad to set the data. For details on the use of the numeric keypad, refer to the section of [5.8 Parameter Setting](#). Alternatively, select the parameter, use the Multipurpose B rotary knob to move the cursor, and use the Multipurpose A rotary knob to adjust the data value. The data range can be set from 00 to FFFFFFFF (10 Fs).

- g. Address & Data: The oscilloscope will be generated when the same address is found during the transmission and the data relation is conform to the set condition. With this trigger condition, it can easily generate the specified address and data trigger of I²C and helpful for the user to analyze the transmission.

When the address length, address, byte length, or data is selected, the corresponding menus can be configured. For the setting of each parameter, refer to (5) *Trigger Condition "Address" and "Data"* above.

8.16. SPI Triggering

- (1) Trigger Type

Press the **Menu** softkey on the front panel or tap the **T** trigger label on the top to open the "Trigger" menu. Tap "Trigger Type" to open the dropdown menu, then select "SPI" to configure the trigger settings.

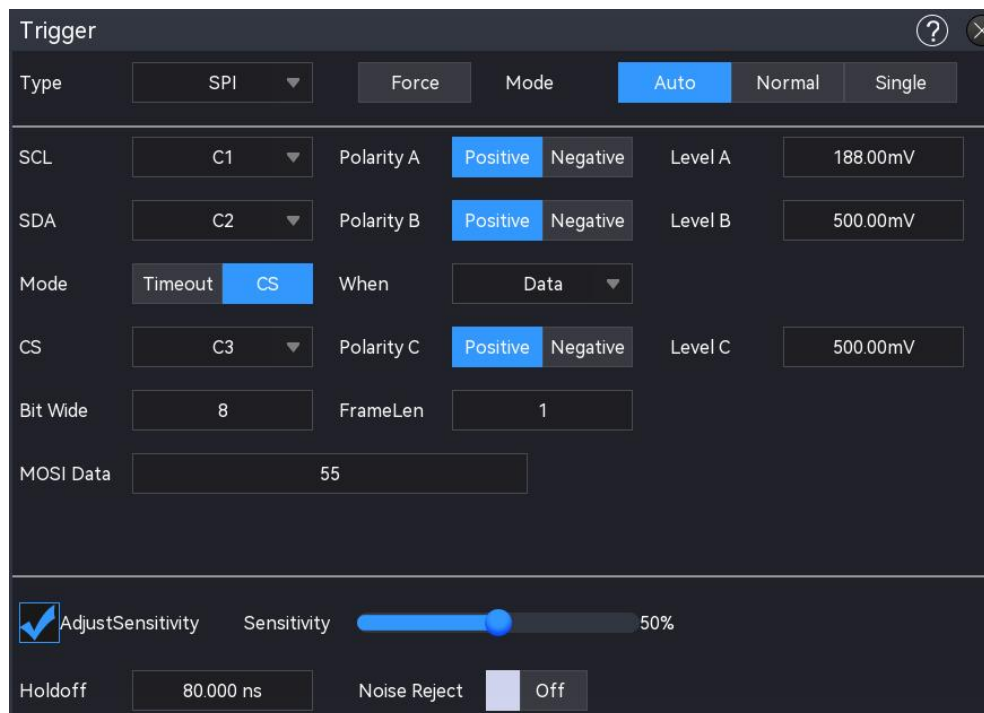

- (2) Source Setting

Set the clock source, data source, and CS (Chip Selection) source. The source can only trigger

stably if the selected channel has a connected signal and is set as the trigger source.

a. Clock Source

Click on the “Clock Source” to select C1-C4 or D0-D15. For more details on *Trigger Source*, refer to the section [Noun Explanation of Triggering System](#). The current source is displayed in the trigger label at the top of the screen.

b. Data Source

Click on the “Data Source” to select C1-C4 or D0-D15. For more details on *Trigger Source*, refer to the section [Noun Explanation of Triggering System](#). The current source is displayed in the trigger label at the top of the screen.

c. Chip Selection Source

It can be set when the mode is CS. Click on the “Source” to select C1-C4 or D0-D15. For more details on *Trigger Source*, refer to the section [Noun Explanation of Triggering System](#). The current source is displayed in the trigger label at the top of the screen.

(3) Edge Setting

a. Clock Polarity

Click on the “Clock Polarity” to select “Positive” or “Negative”.

Positive: Set to trigger on the positive edge of the clock signal.

Negative: Set to trigger on the negative edge of the clock signal.

b. CS Polarity

It can be set when the mode is CS. Click on the “CS Polarity” to select “Positive” or “Negative”.

Positive: The signal is set to 1 if it is greater than the threshold; otherwise, it is 0.

Negative: The signal is set to 1 if it is less than the threshold; otherwise, it is 0.

c. Data Polarity

Click on the “Data Polarity” to select “Positive” or “Negative”.

Positive: The signal is set to 1 if it is greater than the threshold; otherwise, it is 0.

Negative: The signal is set to 1 if it is less than the threshold; otherwise, it is 0.

(4) Level Setting

Click on the “Level A, Level B, or Level C”, and double-click on “Level” input field to open the numeric keypad to set the trigger level. Alternatively, rotate the [Multipurpose A](#) rotary knob to adjust the trigger level, or press the trigger [Position](#) rotary knob on the right side of the front panel to switch the selected trigger level (the selected threshold is displayed in full line) and then rotate rotary knob to change the trigger level.

(5) Mode

Click on the “Mode” to select SPI mode. In SPI mode, timeout and chip selection can be set.

- Timeout: After the clock signal (CLK) remains idle for the specified time, the oscilloscope will trigger when it detects data on MISO that meets the trigger conditions.
- Chip selection: When the Chip Select (CS) signal is valid, the oscilloscope triggers upon detecting data on SDA that meets the specified trigger conditions.

(6) Trigger Condition

Set the trigger condition for SPI. The start and data can be set.

- a. Start: A clock signal will be generated when the timeout meets the trigger condition. When the timeout is selected, the timeout menu can be configured.
 - Timeout: Double-click on the "Timeout" input field to open the numeric keypad to set the timeout. For details on the use of the numeric keypad, refer to the section of [5.8 Parameter Setting](#). Alternatively, select the parameter, use the Multipurpose B rotary knob to move the cursor, and use the Multipurpose A rotary knob to adjust the timeout. The setting range can be set from 99.2 ns to 1 s.
- b. Data: A trigger will be generated when the clock signal meets the idle time and the data signal satisfies the data condition.

When the mode is timeout, timeout, data bit width, and data can be set.

When the mode is CS, data bit width, frame length, and data can be set.

- Timeout: Set the idle time, for the setting method, refer to "Idle time" mentioned above.
- Data bit width: Set the bit width for each unit in SPI protocol, double-click on the "Data Bit Width" input field to open the numeric keypad to set the data bit width. For details on the use of the numeric keypad, refer to the section of [5.8 Parameter Setting](#). Alternatively, select the parameter, use the Multipurpose A to adjust the data bit width. The setting range can be set from 4 to 32 bits.
- Frame length: Set the length for data unit. Double click on the "Frame Length" input field to open the numeric keypad to set the frame length. For details on the use of the numeric keypad, refer to the section of [5.8 Parameter Setting](#). Alternatively, select the parameter, use the Multipurpose A to adjust the frame length. The setting range can be set from 1 to 32.
- Data: The data is related to the frame length. Double-click on the "Data" input field to open the numeric keypad to set the data. For details on the use of the numeric keypad, refer to the section of [5.8 Parameter Setting](#). Alternatively, select the parameter, use the Multipurpose B rotary knob to move the cursor, and use the Multipurpose A rotary knob to adjust the data. The setting range can be set from 0 – FFFFFFFFFFFFFFFFFFFFFFFFFFFFFFFFFF (32 Fs).

8.17. CAN Triggering

(1) Trigger Type

Press the **Menu** softkey on the front panel or tap the **T** trigger label on the top to open the “Trigger” menu. Tap “Trigger Type” to open the dropdown menu, then select “CAN” to configure the trigger settings.

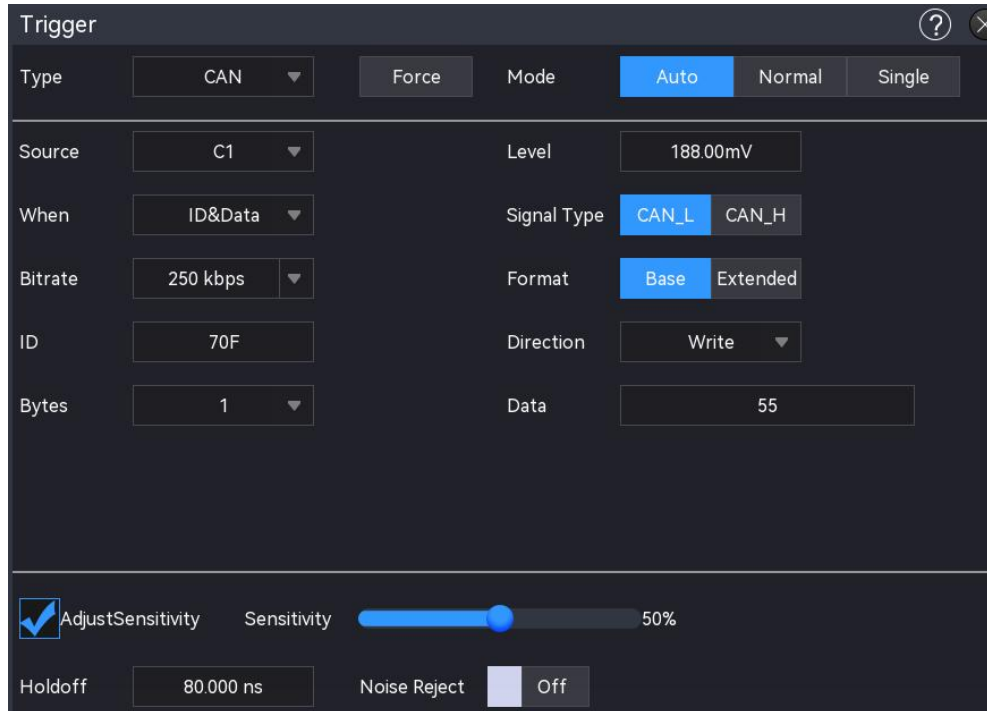

(2) Source

Click on the “Source” to select C1-C4 or D0-D15. For more details on *Trigger Source*, refer to the section [Noun Explanation of Triggering System](#). The current source is displayed in the trigger label at the top of the screen.

The source can only trigger stably if the selected channel has a connected signal and is set as the trigger source.

(3) Level

Double-click on the “Level” input field to open the numeric keypad to set the trigger level. Alternatively, rotate the Multipurpose A rotary knob to adjust the trigger level; or press the trigger Position rotary knob on the right side of the front panel to change the trigger level. When the trigger level is changed, a dotted line appears on the screen indicating the current trigger level. Once the change is stopped, the dotted line of the trigger level disappears after about 2 seconds.

(4) Signal Type

Select whether the current signal accessed by the source is a high data line signal or a low data

line signal. Click on the “Signal type” to select “CAN_H”, or “CAN_L”.

(5) Bitrate

Select the bitrate for CAN serial bus data, click on the “Bitrate” to select 10 kbps, 19.2 kbps, 20 kbps, 33.3 kbps, 38.4 kbps, 50 kbps, 57.6 kbps, 62.5 kbps, 83.3 kbps, 100 kbps, 115.2 kbps, 125 kbps, 230.4 kbps, 250 kbps, 490.8 kbps, 500 kbps, 800 kbps, 921.6 kbps, 1 Mbps, 2 Mbps, 3 Mbps, 4 Mbps, 5 Mbps, or a custom bitrate.

If "Custom" is selected, a custom bitrate can be entered.

(6) Trigger Condition

- a. Start frame: The oscilloscope will trigger on the start of the CAN signal frame.
- b. Data frame: Triggered on the data frame that matches with the CAN signal.
- c. Remote frame: Triggered on the remote frame.
- d. Error frame: Triggered on the error frame of the CAN signal.
- e. Overload frame: Triggered on the overload frame of the CAN signal.
- f. Identifier: Triggered on the data frame that matches with the specified ID.

When the identifier, frame format, or direction is selected, the corresponding menus can be configured.

- Identifier: Double-click on the “Identifier” input field to open the numeric keypad to set the identifier. For details on the use of the numeric keypad, refer to the section of [5.8 Parameter Setting](#). Alternatively, select the parameter, use the Multipurpose B rotary knob to move the cursor, and use the Multipurpose A rotary knob to adjust the identifier. The setting range can be set from 000 to 7FF and from 00000000 to 1FFFFFFF.
- Frame format: Click on the “Frame Format” to set the format to standard or extend. The different frame formats have different ID ranges.
- Direction: Click on the “Direction” to set the direction for the identifier. The direction can be set to “Write”, “Read”, or “Read or Write”.
 - Write: The oscilloscope will be generated when CAN protocol “Read/Write” bit is “Write”.
 - Read: The oscilloscope will be generated when CAN protocol “Read/Write” bit is “Read”.
 - Read or write: The oscilloscope will be generated when CAN protocol “Read/Write” bit is “Read or Write”.
- g. Data: The waveform will be generated when the data acquired by CAN is the same as the custom data. It can help the user to quickly find the transmission signal that the specific data they are interested in.

When the byte length or data is selected, the corresponding menus can be configured.

- **Byte length:** Different byte lengths have different data ranges. Double-click on the “Byte Length” input field to select the byte length. The setting range can be set from 1 to 8.
 - **Data:** Set the trigger data, double-click on the “Data” input field to open the numeric keypad to set the data. For details on the use of the numeric keypad, refer to the section of [5.8 Parameter Setting](#). Alternatively, select the parameter, use the Multipurpose B rotary knob to move the cursor, and use the Multipurpose A rotary knob to adjust the data.
- h. **ID and Data:** Triggered on the data frame that matches the specified ID and data. When the identifier, frame format, direction, byte length, or data is selected, the corresponding menus can be configured. For the setting of each parameter, refer to (6) Trigger Condition “*Identifier*” and “*Data*” mentioned above.
- i. **End of frame:** Triggered on the end of frame of CAN signal.
- j. **Loss confirmed:** Triggered on the loss confirmed of CAN signal.
- k. **Bit stuff error:** In the segment requiring bit filling, the waveform will trigger upon detecting an error from 6 consecutive bits of the same level.
- l. **CRC error:** Triggered when a CRC error occurs.
- m. **All error:** Triggered by all errors, including bit stuff errors and CRC errors.

8.18. CAN-FD Triggering

(1) Trigger Type

Press the Menu softkey on the front panel or tap the **T** trigger label on the top to open the “Trigger” menu. Tap “Trigger Type” to open the dropdown menu, then select “CAN-FD” to configure the trigger settings.

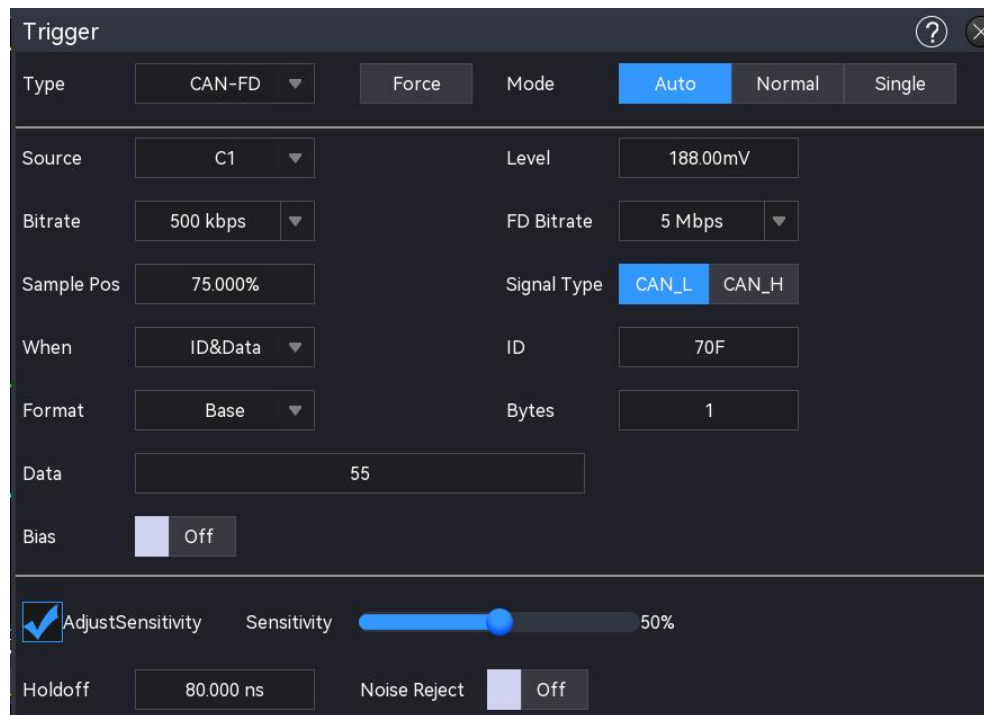

(2) Source

Click on the “Source” to select C1-C4 or D0-D15. For more details on *Trigger Source*, refer to the section [Noun Explanation of Triggering System](#). The current source is displayed in the trigger label at the top of the screen.

The source can only trigger stably if the selected channel has a connected signal and is set as the trigger source.

(3) Level

Double-click on the “Level” input field to open the numeric keypad to set the trigger level. Alternatively, rotate the Multipurpose A rotary knob to adjust the trigger level; or press the trigger Position rotary knob on the right side of the front panel to change the trigger level. When the trigger level is changed, a dotted line appears on the screen indicating the current trigger level. Once the change is stopped, the dotted line of the trigger level disappears after about 2 seconds.

(4) Signal Type

Select whether the current signal accessed by the source is a high data line signal or a low data line signal. Click on the “Signal type” to select “CAN_H”, or “CAN_L”.

(5) Bitrate

Select the bitrate for CAN-FD serial bus data, click on the “Bitrate” to select 10 kbps, 19.2 kbps, 20 kbps, 33.3 kbps, 38.4 kbps, 50 kbps, 57.6 kbps, 62.5 kbps, 83.3 kbps, 100 kbps, 115.2 kbps, 125 kbps, 230.4 kbps, 250 kbps, 490.8 kbps, 500 kbps, 800 kbps, 921.6 kbps, 1 Mbps, 2 Mbps, 3 Mbps, 4 Mbps, 5 Mbps, or a custom bitrate.

If "Custom" is selected, a custom bitrate can be entered.

(6) FD Bitrate

Select the FD bitrate for CAN-FD serial bus data, click on the "FD Bitrate" to select 250 kbps, 500 kbps, 800 kbps, 1 Mbps, 1.5 Mbps, 2 Mbps, 4 Mbps, 5 Mbps, 6 Mbps, 8 Mbps, or a custom FD bitrate. If "Custom" is selected, a custom FD bitrate can be entered.

(7) Sampling Position

The sample position is the point in the bit time where the oscilloscope samples the bit level. The sample position is expressed as a percentage of the "Time from bit start to sample point" and the "Bit time".

Click on the "Sampling position" input field to open the numeric keypad to set the sampling position. Alternatively, rotate the Multipurpose A rotary knob to adjust the sampling position.

The range can be set to from 30% to 90%.

(8) Trigger Condition

- a. Start frame: The oscilloscope will trigger on the start of the CAN-FD signal frame.
- b. Data frame: Triggered on the data frame that matches with the CAN-FD signal.
- c. Remote frame: Triggered on the remote frame.
- d. Error frame: Triggered on the error frame of the CAN-FD signal.
- e. Overload frame: Triggered on the overload frame of the CAN-FD signal.
- f. Identifier: Triggered on the data frame that matches with the specified ID.

When the ID or frame format is selected, the corresponding menus can be configured.

- ID: Double-click on the "ID" input field to open the numeric keypad to set the ID. For details on the use of the numeric keypad, refer to the section of [5.8 Parameter Setting](#). Alternatively, select the parameter, use the Multipurpose B rotary knob to move the cursor, and use the Multipurpose A rotary knob to adjust the ID. The ID range can be set from 000 to 7FF and from 00000000 to 1FFFFFFF.
 - Frame format: Click on the "Frame Format" to set the format to standard, extend, FD standard, or FD extend. The different frame formats have different ID ranges. The "Standard, extend" format is suitable for CAN signal. "FD standard, FD extend" format is suitable for CAN-FD signal.
- g. Data: The waveform will be generated when the data acquired by CAN-FD is the same as the custom data. It can help the user to quickly find the transmission signal that the specific data they are interested in.

When the byte length, data, offset, or byte offset is selected, the corresponding menus can be configured.
 - Byte length: Different byte lengths have different data ranges. Double-click on the

“Byte Length” input field to select the byte length. For details on the use of the numeric keypad, refer to the section of [5.8 Parameter Setting](#). Alternatively, select the parameter, use the Multipurpose A rotary knob to adjust the byte length. The setting range can be set from 1 to 16.

- Data: Set the trigger data, double-click on the “Data” input field to open the numeric keypad to set the data. For details on the use of the numeric keypad, refer to the section of [5.8 Parameter Setting](#). Alternatively, select the parameter, use the Multipurpose B rotary knob to move the cursor, and use the Multipurpose A rotary knob to adjust the data.
 - Offset: Set the data offset of byte data for delay trigger. Click on the “Offset” to toggle it ON or OFF.
ON: Displays the “Byte Offset” menu.
OFF: Hide the “Byte Offset” menu.
 - Byte offset: Double-click on the “Byte Offset” input field to open the numeric keypad to set the byte offset. Double-click on the “Byte Offset” input field to select the byte offset. For details on the use of the numeric keypad, refer to the section of [5.8 Parameter Setting](#). Alternatively, select the parameter, use the Multipurpose A rotary knob to adjust the byte offset. The setting range can be set from 0 to 63.
- h. ID and Data: Triggered on the data frame that matches the specified ID and data. When the ID, frame format, byte length, data, offset, or byte offset is selected, the corresponding menus can be configured. For the setting of each parameter, refer to (8) Trigger Condition “*Identifier*” and “*Data*” mentioned above.
- i. End of frame: Triggered on the end of frame of CAN - FD signal.
- j. Loss confirmed: Triggered on the loss confirmed of CAN - FD signal.
- k. Bit stuff error: In the segment requiring bit filling, the waveform will trigger upon detecting an error from 6 consecutive bits of the same level.
- l. CRC error: Triggered when a CRC error occurs.
- m. All error: Triggered by all errors, including bit stuff errors and CRC errors.

8.19. LIN Triggering

(1) Trigger Type

Press the Menu softkey on the front panel or tap the **T** trigger label on the top to open the “Trigger” menu. Tap “Trigger Type” to open the dropdown menu, then select “LIN” to configure the trigger settings.

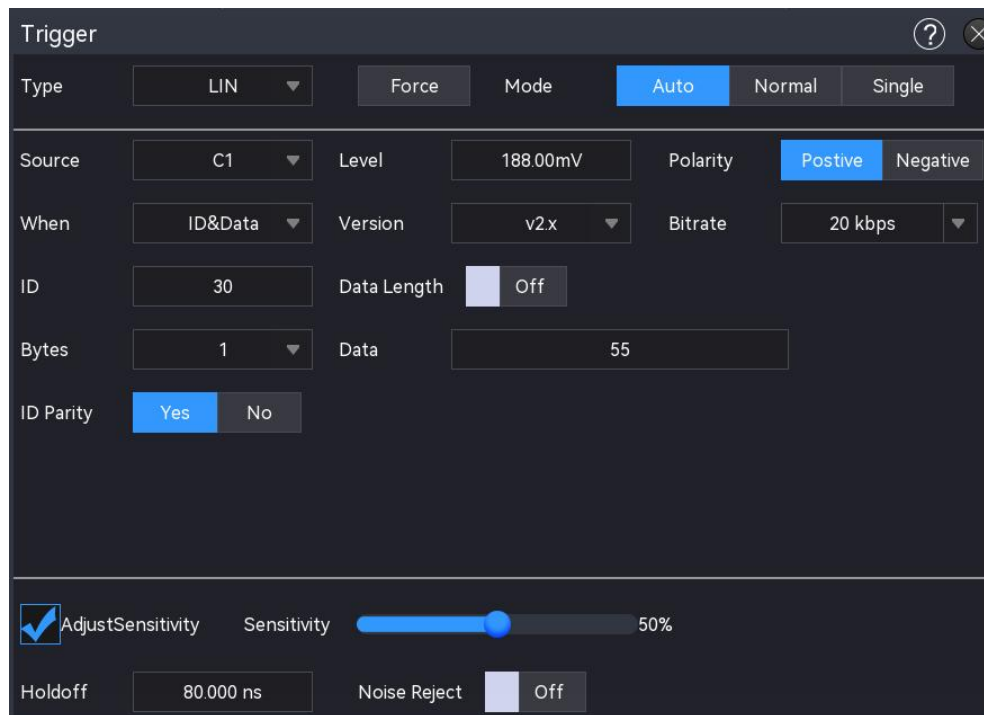

(2) Source

Click on the “Source” to select C1-C4 or D0-D15. For more details on *Trigger Source*, refer to the section [Noun Explanation of Triggering System](#). The current source is displayed in the trigger label at the top of the screen.

The source can only trigger stably if the selected channel has a connected signal and is set as the trigger source.

(3) Polarity

Click on the “Polarity” to select the polarity to “Normal (high=1)” or “Reverse (high=0)”.

(4) Level

Double-click on the “Level” input field to open the numeric keypad to set the trigger level.

Alternatively, rotate the Multipurpose A rotary knob to adjust the trigger level; or press the trigger Position rotary knob on the right side of the front panel to change the trigger level.

When the trigger level is changed, a dotted line appears on the screen indicating the current trigger level. Once the change is stopped, the dotted line of the trigger level disappears after about 2 seconds.

(5) Version

Click on the “Version” to select the signal version to v1.x, v2.x, or arbitrary.

(6) Bitrate

Select the bitrate for LIN, click on the “Bitrate” to select 1.2 kbps, 2.4 kbps, 4.8 kbps, 9.6 kbps, 10.417 kbps, 19.2 kbps, 20 kbps, or a custom bitrate.

If "Custom" is selected, a custom bitrate can be entered.

(7) ID Parity Check

Set ID Parity check to toggle it ON or OFF.

ON: Includes parity bit and ID.

OFF: Does not include parity bit and ID.

(8) Data Length Menu

Set whether to display the data length menu. Click on the "Data Length" to toggle it ON or OFF.

ON: Displays the data length menu.

OFF: Hide the data length menu.

(9) Data Length

Set LIN data length. Double-click on the "Data Length" input field to open the numeric keypad to set the data length. For details on the use of the numeric keypad, refer to the section of [5.8 Parameter Setting](#). Alternatively, select the parameter, use the Multipurpose A rotary knob to adjust the byte offset. The data length can be set from 1 to 8. It is only available when the data length menu is displayed.

(10) Trigger Condition

- a. Synchronization: The oscilloscope will be generated when detecting a synchronizing signal.
- b. Identifier: The oscilloscope will be generated when detecting ID is equal to the setting frame.

When the ID is selected, the ID menu can be configured.

- ID: Double-click on "ID" input field to open the numeric keypad to set the ID. For details on the use of the numeric keypad, refer to the section of [5.8 Parameter Setting](#). Alternatively, select the parameter, use the Multipurpose B rotary knob to move the cursor, and use the Multipurpose A rotary knob to adjust the ID.

When ID including parity bit is set to "ON", the range is from 00 to FF.

When ID including parity bit is set to "OFF", the range is from 00 to 3F.

- c. Data: The waveform will be generated when the data is the same as the custom data. It can help the user to quickly find the transmission signal that the specific data they are interested in.

When the byte length or data is selected, the corresponding menus can be configured.

- Byte length: Different byte lengths have different data ranges. Click on the "Data" input field to select the byte length. The setting range can be set from 1 to 8.
- Data: Set the trigger data. Double-click on the "Data" input field to open the numeric keypad to set the data. For details on the use of the numeric keypad, refer to the section of [5.8 Parameter Setting](#). Alternatively, select the parameter, use the Multipurpose B rotary knob to move the cursor, and use the Multipurpose A rotary

knob to adjust the data. The data range can be set from 00 to FFFFFFFFFFFFFFFF.

- d. ID and Data: Triggered on the data frame that matches the specified ID and data.

When the ID, byte length, or data is selected, the corresponding menus can be configured. For the setting of each parameter, refer to (10) Trigger Condition “Identifier” and “Data” mentioned above.

- e. Wake-up frame: Triggered on the signal's wake-up frame.
 f. Sleep frame: Triggered on the signal's sleep frame.
 g. Error: Triggered on the LIN signal's sleep frame.

When the error type is selected, the error type menu can be configured.

- Error type: Click on the “Error type” to select synchronization, ID Parity check, and checksum.
 - Synchronization: Synchronizing error
 - ID Parity check: ID parity check error
 - Checksum: Data check and error

8.20. Audio Triggering

In the Audio triggering type, the oscilloscope recognizes the trigger condition by referencing the specified data value. You need to specify the serial clock line (SCLK, which receives 1 pulse on the clock line for every 1-bit digital audio data sent), the frame clock line (WS, which toggles the data of the audio channel), and the serial data line (SDA, which transmits the audio data expressed as binary complements). The following figure shows the Audio bus sequence chart.

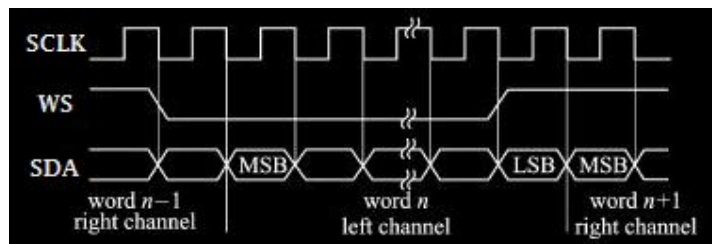

- (1) Trigger Type

Press the Menu softkey on the front panel or tap the **T** trigger label on the top to open the “Trigger” menu. Tap “Trigger Type” to open the dropdown menu, then select “Audio” to configure the trigger settings.

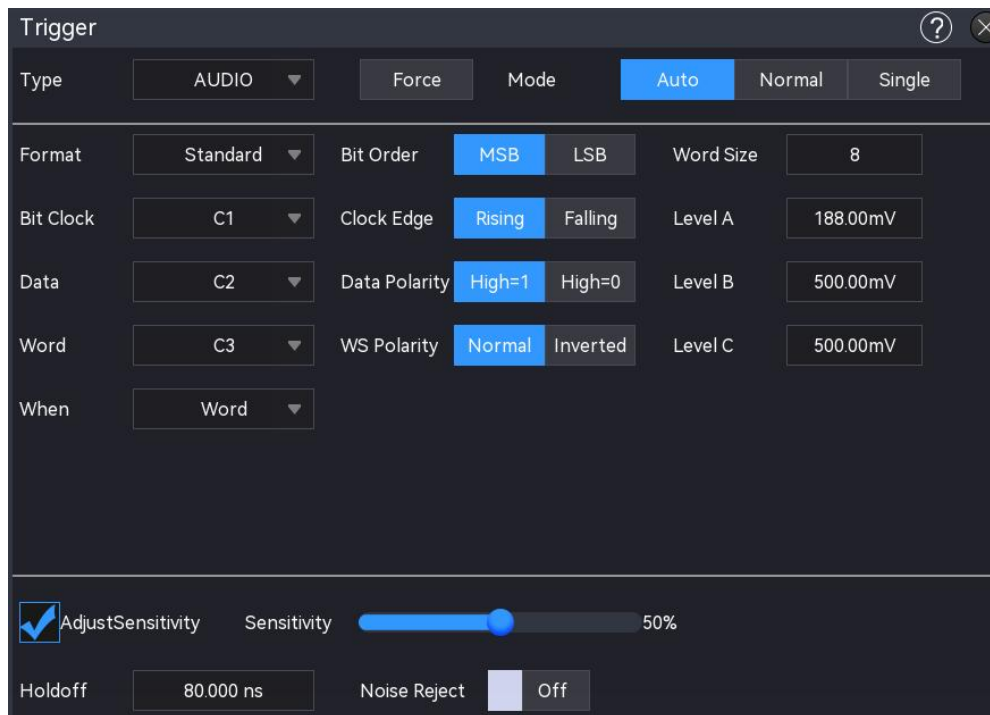

(2) Format

Click on the “Format” to select standard, left justifying, right justifying, or TDM.

- **Standard:** The MSB of each sampled data is sent first, followed by the LSB. The MSB is displayed on the SDATA line one clock bit after the WS transition edge.

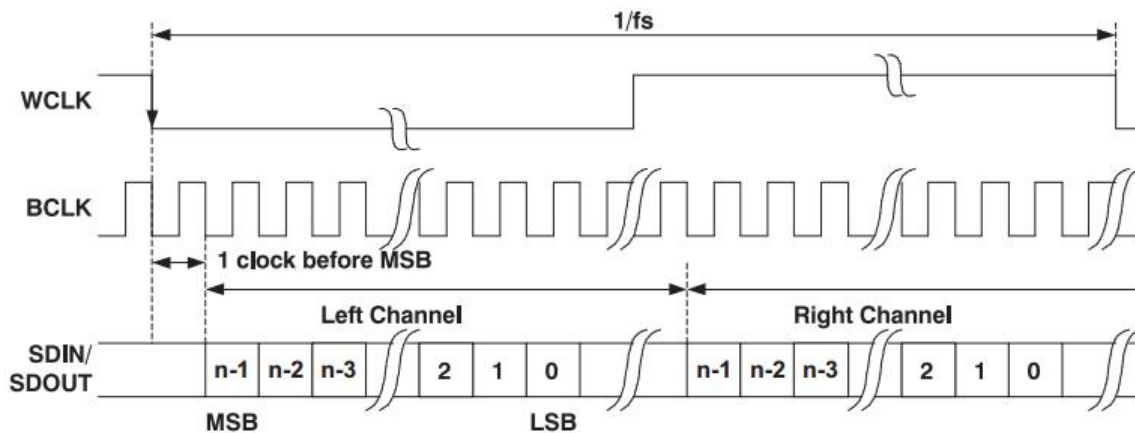

- **Left justifying:** Data transmission (MSB first) starts at the WS transition edge, without the one-bit delay used in the standard format.

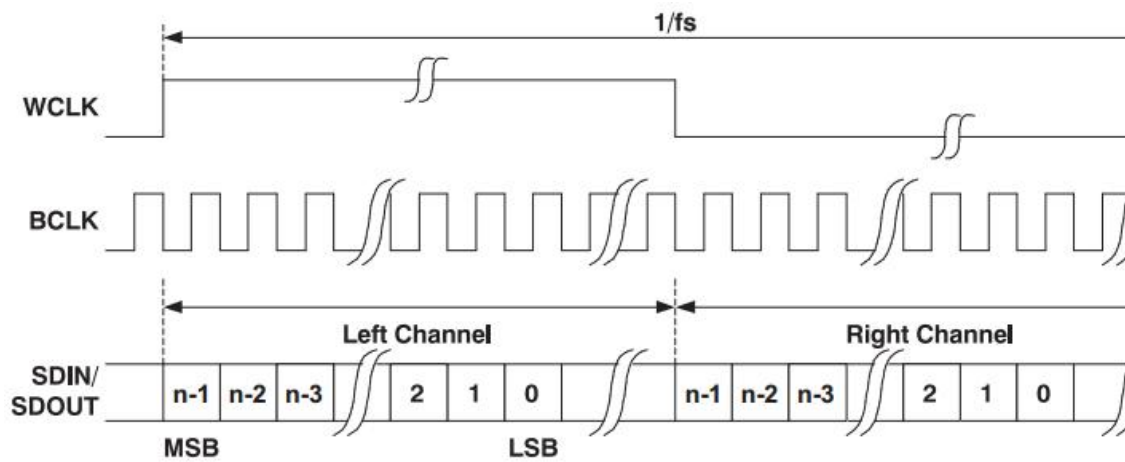

- Right justifying: Data transmission (MSB first) is right aligned with the WS signal.

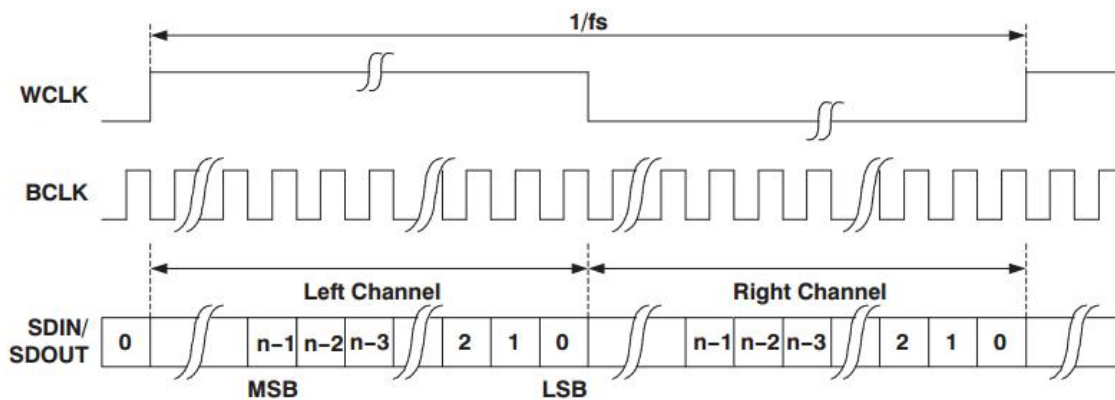

- TDM: (Time Division Multiplexing) mode allows the transmission of multi-channel data.

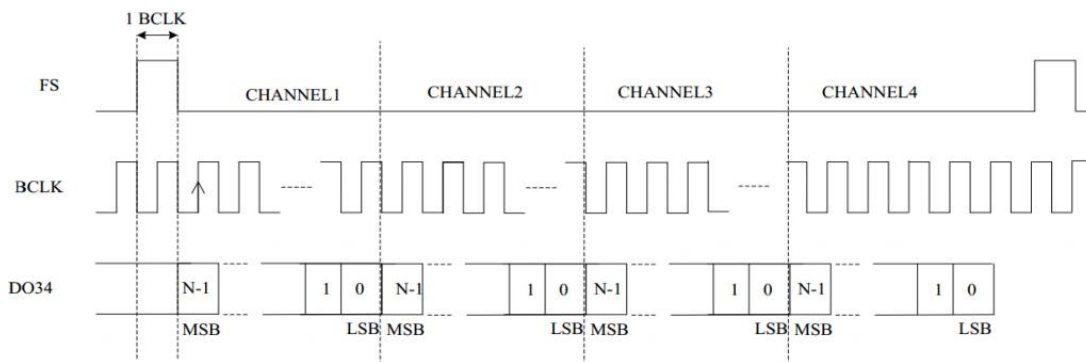

(3) Bit Sequence

Click on the “Bit Sequence” to select “LSB” or “MSB”. The default is “MSB”.

(4) Source Setting

Set bit clock, bit selection, and data source. The source can only trigger stably if the selected channel has a connected signal and is set as the trigger source.

a. Bit Clock

Click on the “Bit Clock” to select C1-C4 or D0-D15. For more details on *Trigger Source*, refer to the section [Noun Explanation of Triggering System](#). The current source is displayed in the trigger label at the top of the screen. The clock line (SCLK) provides the clock signal

for synchronizing audio data transmission.

b. Bit Selection

Click on the “Bit Selection” to select C1-C4 or D0-D15. For more details on *Trigger Source*, refer to the section [Noun Explanation of Triggering System](#). The current source is displayed in the trigger label at the top of the screen. The bit selection indicates the audio data of the current transmission is left channel or right channel.

c. Data

Click on the “Data” to select C1-C4 or D0-D15. For more details on *Trigger Source*, refer to the section [Noun Explanation of Triggering System](#). The current source is displayed in the trigger label at the top of the screen. The data line is used to transmit actual audio data.

d. Frame Synchronization

Click on the “Frame Synchronization” to select C1-C4 or D0-D15. For more details on *Trigger Source*, refer to the section [Noun Explanation of Triggering System](#). The current source is displayed in the trigger label at the top of the screen.

(5) Edge Setting

a. Clock Edge

Click on the “Clock” to select “Rising” or “Falling” edge.

Rising edge: Samples SDA on the rising edge of the clock.

Falling edge: Samples SDA on the falling edge of the clock.

b. WS Polarity

Click on the “WS Polarity” to select “Normal” or “Reverse”. The WS polarity determines the valid level for the bit selection signal. The bit selection signal indicates the start frame and end of frame for the audio data.

c. Data Polarity

Click on the “Data Polarity” to select “high=1” or “high=0”.

d. Polarity Synchronization

Click on the “Polarity Synchronization” to set the edge for the frame synchronization signal to the “Rising” or “Falling” edge.

(6) Level

Click on the “Level A, Level B, Level C, or Level D”, and double-click on “Level” input field to open the numeric keypad to set the trigger level. Alternatively, rotate the [Multipurpose A](#) rotary knob to adjust the trigger level, or press the trigger [Position](#) rotary knob on the right side of the front panel to switch the selected trigger level (the selected threshold is displayed in full line) and then rotate rotary knob to change the trigger level.

(7) Data Format (do not select TDM)

When the data format is standard, left justifying, or right justifying is selected, the bit size and trigger mode (bit selection and data) menus can be configured.

a. Bit Size

The bit size can be set when the format is standard, left justifying, or right justifying.

Double-click on the “Bit Size” input field to open the numeric keypad to set the bit size. For details on the use of the numeric keypad, refer to the section of [5.8 Parameter Setting](#).

Alternatively, use the Multipurpose A rotary knob to adjust the byte offset. The byte offset range can be set from 4 to 32.

b. Trigger Type

■ Bit Selection: Triggered on the bit selection.

■ Data: The oscilloscope will be generated when the data meets the setting value in the sound channel.

When the Audio or data is selected, the corresponding menus can be configured.

- Audio: Click on the “Audio” to select any, left channel, or right channel.

- Data: Double-click on the “Data” input field to open the numeric keypad to set the data. For details on the use of the numeric keypad, refer to the section of [5.8](#)

[Parameter Setting](#). Alternatively, select the parameter, use the Multipurpose B rotary knob to move the cursor, and use the Multipurpose A rotary knob to adjust the data.

(8) Data Format (select TDM)

When the format is standard, left justifying, right justifying, data bit per channel, clock bit per channel, channel number per frame, bit delay, or trigger condition (frame synchronization, data, channel, and data) is selected, the corresponding menus can be configured.

a. Data Bit per Channel

Double-click on the “Data Bit per Channel” input field to open the numeric keypad to set this value. For details on the use of the numeric keypad, refer to the section of [5.8](#)

[Parameter Setting](#). Alternatively, use the Multipurpose A rotary knob to adjust this value.

The setting range can be set from 4 to 32.

The set value of each channel data bit \leq the set value of each channel clock bit.

b. Clock Bit per Channel

Double-click on the “Clock Bit per Channel” input field to open the numeric keypad to set this value. For details on the use of the numeric keypad, refer to the section of [5.8](#)

[Parameter Setting](#). Alternatively, use the Multipurpose A rotary knob to adjust this value.

The setting range can be set from 4 to 32.

c. Channel Number per Frame

Double-click on the “Channel Number per Frame” input field to open the numeric keypad

to set this value. For details on the use of the numeric keypad, refer to the section of [5.8 Parameter Setting](#). Alternatively, use the [Multipurpose A](#) rotary knob to adjust this value. The setting range can be set from 2 to 64.

d. Bit Delay

Double-click on the “Bit Delay” input field to open the numeric keypad to set this value. For details on the use of the numeric keypad, refer to the section of [5.8 Parameter Setting](#). Alternatively, use the [Multipurpose A](#) rotary knob to adjust this value. The setting range can be set from 0 to 31.

The set value of bit delay < The set value of each channel clock bit.

e. Trigger Condition

- Synchronization frame: Triggered on the synchronization frame.
- Data: The oscilloscope will be generated when the data meets the setting value. When the data is selected, the data menu can be configured.
 - Data: Double-click on the “Data” input field to open the numeric keypad to set the data. For details on the use of the numeric keypad, refer to the section of [5.8 Parameter Setting](#). Alternatively, use the [Multipurpose A](#) rotary knob to adjust the data.
- Channel and data: The oscilloscope will be generated when the channel and data meet the setting value. When the channel or data is selected, the corresponding menus can be configured.
 - Channel: Double-click on the “Channel” input field to open the numeric keypad to set the channel number. For details on the use of the numeric keypad, refer to the section of [5.8 Parameter Setting](#). Alternatively, use the [Multipurpose A](#) rotary knob to adjust the channel number.
 - Data: Double-click on the “Data” input field to open the numeric keypad to set the data. For details on the use of the numeric keypad, refer to the section of [5.8 Parameter Setting](#). Alternatively, use the [Multipurpose A](#) rotary knob to adjust the data.

8.21. Zone Triggering

For complicated and volatile circuit signal in circuit debugging, the oscilloscope with high waveform capture rate can easily observe fleeting accidental abnormal signal. If users want to separate the abnormal signal from complicated and volatile circuit and to stable triggered. It may take a lot of time to learn the use of some advanced trigger, and even so, some more powerful advanced trigger also cannot be fully triggered.

MSO1000HD series adds the screen touch regional trigger function, it's helpful for users to get the use of advanced trigger. Zone triggering function is very easy to use. Users only need to open rectangle drawing function to draw one or two rectangle areas in the corresponding signal, it can quickly separate it and for observing signal. Zone triggering can be combined with basic trigger, advanced trigger and protocol trigger function, and it also supports decoding, waveform recording and pass/fail test. It's handy for debugging complicated signals.

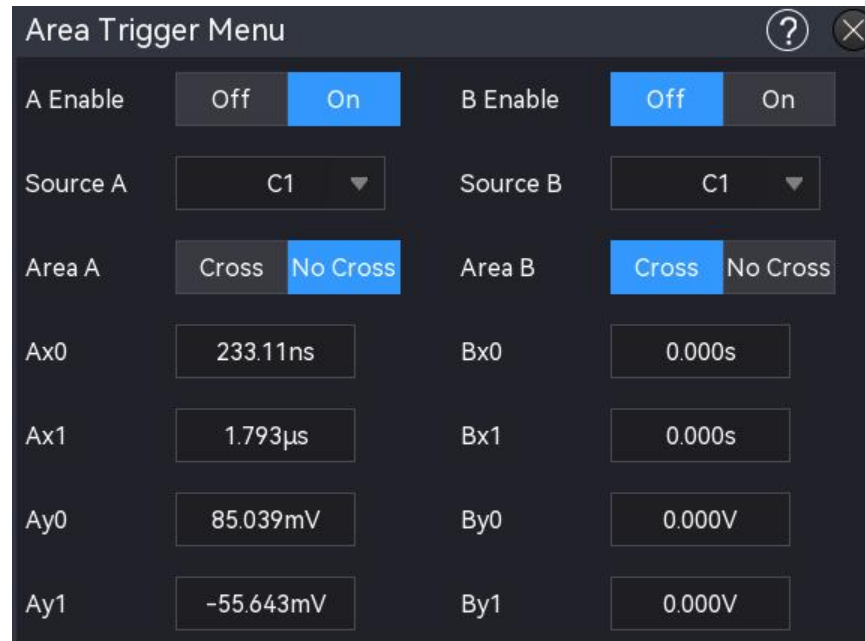

Zone triggering provides two rectangle areas: Zone A and Zone B. Both regions support setting the region trigger condition to intersection or non-intersection; and the two regions support setting the corresponding enable sources C1-C4.

- (1) "Rectangle drawing" setting menu: Enable Zone A, Source A, Zone A, enable Zone B, Source B, and Zone B.
 - a. Enable Zone A: Toggle Zone A to ON or OFF.
If there is a zone box on the screen, ON: displays the zone box, OFF: hides the region box.
 - b. Source A: Set the source of Zone A, it can set to C1-C4.
 - c. Zone A: Set whether Zone A is intersected with Source A.
 - d. Enable Zone B: Toggle Zone B to ON or OFF.
If there is a region box on the screen, ON: displays the region box, OFF: hides the region box.
 - e. Source B: Set the source of Zone B, it can set to C1-C4.
 - f. Zone B: Set whether Zone B is intersected with Source B.
- (2) Zone box setting menu: Cancel, 1: intersection, 1: non-intersection, 2: intersection, 2: non-intersection.

- a. Cancel: Close the currently drawn zone and cancel the condition setting.
- b. A: intersection: The currently drawn region as Zone A, condition: Zone A will trigger if it intersects with the waveform and will not trigger if it does not intersect the waveform.
- c. A: non-intersection: The currently drawn region as Zone A, condition: Zone A will trigger if it does not intersect the waveform and will not trigger if it does intersect the waveform.
- d. B: intersection: The currently drawn region as Zone B, condition: Zone B will trigger if it intersects with the waveform and will not trigger if it does not intersect the waveform.
- e. B: non-intersection: The currently drawn region as Zone B, condition: Zone B will trigger if it does not intersect the waveform and will not trigger if it does intersect the waveform.

(3) Zone boundary setting

Area trigger boxes can be quickly drawn with gestures, and for boundary fine-tuning, check the corresponding boundary input box and use the Multipurpose rotary knob to modify the data values.

- a. Ax0, Ax1, Ay0, and Ay1 represent the left, right, top, and bottom boundaries of zone A, respectively.
- b. Bx0, Bx1, By0, By1 represent the left, right, top, and bottom boundaries of zone B, respectively.

Intersecting areas display blue borders, while non-intersecting areas display gray borders. The setting menu can be displayed by clicking the region trigger box on the screen. Or you can touch the horizontal position and vertical position of the region trigger box in the moving area. When adjusting the time base scale and volts/div of the waveform, the region trigger box will expand and compress accordingly.

Open the region trigger on the abnormal signal, as shown in the following figure.



If the currently selected region already exists, then the current region trigger information will replace the original region trigger message and the region trigger box will be closed. When the instrument is rebooted up, the region trigger setting will not be saved.





Note: If both area A and area B are enabled simultaneously, the "AND" operation becomes the final trigger condition.

9. Protocol Decoding

- [RS232 Decoding](#)
- [I²C Decoding](#)
- [SPI Decoding](#)
- [CAN Decoding](#)
- [CAN-FD Decoding](#)
- [LIN Decoding](#)
- [Audio Decoding](#)

Users can easily find errors, debug hardware and accelerate the development progress through the protocol decoding, to provide a guarantee of high speed and high quality to complete the project. MSO1000HD provides four bus decoder modules (Decoder 1, Decoder 2, Decoder 3, and Decoder 4) to decode common protocols for analogue channel input signals. MSO1000HD has protocol decoding of RS232, I²C, SPI, CAN, CAN-FD, LIN, Audio. As Decode 1, Decode 2, Decode 3, and Decode 4 have the same decoding function and setting method, this chapter uses Decode 1 as an example.

Access the decoding setting menu using the following steps.

- Press the key  on the front panel to enter the decoding setting menu.
- Click the Home icon  in the top right corner of the screen, click the decoding icon  to enter the decoding setting menu.
- If the decoding function is added in the toolbar, click the decoding icon  in the top right corner of the screen to enter the decoding setting menu.

9.1. RS232 Decoding

RS232 is an asynchronous transmission standard interface established by Electronic Industries Association. It usually includes two application formats DB-9 or DB-25. It is suitable for the communication that the data transmission rate within the range 0-29491200/s.

It is widely used in microcomputer interface, the data to be transmitted is combined into a specified set of serial bits according to the protocol rules and sent it in an asynchronous serial way.

The data to be transmitted for each time, composing by the following rules.

Send one start bit at first, and send 5-8 data bits, and send optional parity check bit, and send one or two stop bits at last. The number of data bits is agreed by both communicating parties, it can be 5-8 bits, with no parity check bit, odd parity check bit, or even parity check bit. The stop bit can be set to one bit or two bits. In the following description, a transmission of a data string is referred to as a frame.

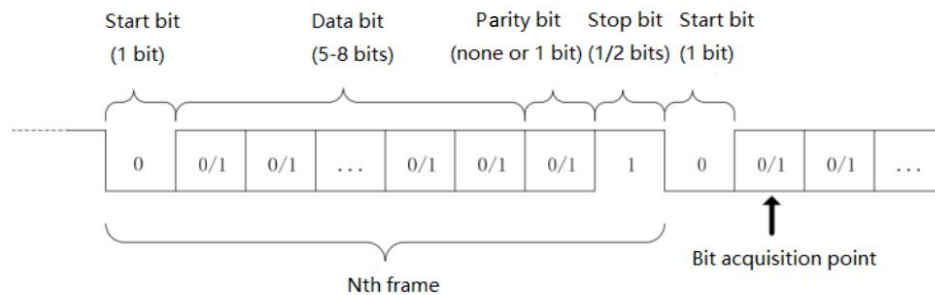

(1) Decoding Menu Setting

a. Protocol Type

Click on the "Protocol Type" to select "UART/RS232".

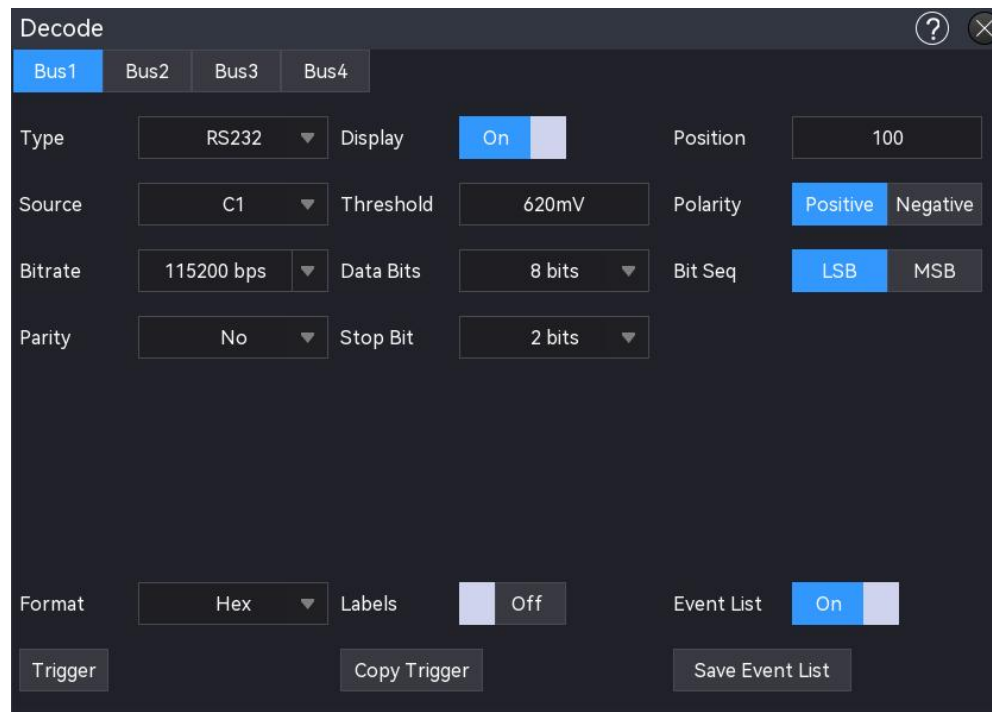

b. Source

Click on the "Source" to select CH1-CH4 or D0-D15. The current source is displayed in the top right corner of the screen. When the digital channel is enabled, the source can be set to D0-D15 and displayed.

Note: The source can only be triggered stably and decoded correctly when the selected

- channel has a connected signal and is set as the trigger source.
- c. Threshold
Set the threshold of source. Tap to select the “Threshold” input field, rotate the Multipurpose A rotary knob to adjust the threshold. Alternatively, double-click on the “Threshold” input field to open the numeric keypad to set the threshold. The threshold range is related to the vertical scale and vertical offset of the source.
 - d. Polarity
Click on the “Polarity” to select positive or negative.
 - Negative: The reversed polarity of logic level, i.e. the high level is 0 and the low level is 1.
 - Positive: The normal polarity of logic level, i.e. the high level is 1 and the low level is 0.
 - e. Parity Check
Set the parity check of data transmission. Click on the “Parity check” to select none, even parity check, or odd parity check.
 - f. Data Bit
Set the data bit width for the specified decoding RS232 protocol signal. Click on the “Data Bit” to select 5 bits, 6 bits, 7 bits, or 8 bits.
 - g. Bit Sequence
Set the data bit sequence for RS232 protocol signal. Click on the “Bit Sequence” to select MSB or LSB.
 - MSB: The Most Significant Bit, i.e., the bit with the highest value in a sequence, transmitted first.
 - LSB: The Least Significant Bit, i.e., the bit with the lowest value in a sequence, transmitted last.
 - h. Stop Bit
Set the stop bit for each data, click on the “Stop bit” to select 1 bit or 2 bits.
 - i. Bitrate
When RS232 communication is asynchronous transmission communication, no accompanying clock signal during the data transmission process, to solve the determination of data bits, the protocol requires that the two sides of communication to agree on the bit rate. Generally, the bit rate is defined as the number of bits that can be transmitted for 1 s time, for example, 9600 bps means that 9600 bits can be transmitted for 1 s. The bitrate is not directly equal to the effective data transmission rate. Note that the start bit, data bit, checksum and stop bit are all counted as bit bits, so the bitrate is not directly equal to the effective data rate. The oscilloscope will set the bitrate according to

the bitrate from bit sampling.

Bitrate can be set to 2400 bps, 4800 bps, 9600 bps, 19200 bps, 38400 bps, 57600 bps, 115200 bps, or a custom bitrate. Open the numeric keypad to set the custom bitrate.

It is recommended to make reasonable settings according to your RS232 communication hardware and software. Due to the basic model of this transmission protocol, RS232 protocol is usually used in short distance (less than 20 m), low speed (less than 1 Mbps) transmission occasions, and the communication outside of this range is susceptible to interference and becomes unreliable.

(2) Decoding Bus Setting

a. Bus Switch

Click on the “Bus Switch” to switch on/off the bus function.

b. Decoding Line

Set the display position of decoding bus on the screen. The display position of decoding line can be adjusted by using Multipurpose A rotary knob. Alternatively, double-click on the “Decoding Line” input field to open the numeric keypad to set the position. The range can be set from 0 to 560.

c. Format

Set the display format for the decoding bus and event list decoding. Click on the “Format” to select hexadecimal, decimalism, binary, or ASCII.

d. Label

Click on the “Label” to switch on/off the decoding bus label. When the decoding bus label is switched on, it will display on the left top and display the current protocol type. When the decoding bus label is switched off, it will not be displayed.

(3) Event List

Click on the “Event List” to switch on/off the event list. When the event list is switched on, it will be displayed as shown in the following figure. Click the event list icon “x” in the right top to close it.



(4) Save Event List

When the operating state is RUN/STOP, the time and decoding data in the current event list can be exported.

Click the “Save Event List” key in the decoding menu to open the export setting menu, the data can be saved in *.csv, *.html, and *.pdf to internal storage or external USB flash drive (when a USB flash drive is detected). For the setting steps, refer to [Save and Load](#) section.

Note: When the operating state is RUN, the decoding data may be unstable, the user can manually stop the oscilloscope to export a stable decoding signal.

(5) Jump to Trigger Menu

Click on the “Trigger” to directly navigate to the trigger menu, where the trigger type is same with the decoding type.

(6) Copy Trigger Settings

When the trigger type and parameter settings are completed, and the decoding type is the same, click on the “Copy Trigger” on the decoding page to transfer the parameter settings to the decoding menu.

9.2. I²C Decoding

I2C trigger is usually used to connect microcontrollers and peripheral devices, it's widely used in microelectronics area. This bus protocol has two lines to transmit, one line is serial data SDA, and another line is serial clock SCL. Use a master-slave system for communication, enabling two-way

communication between the master and slave computers.

This bus is the bus of multiple masters, preventing data corruption through conflict demodulation and arbitration mechanisms. It is worth noting that the I2C bus has two address bit width, 7 bits and 10 bits, 10 bits and 7 bits address are compatible and can be used in combination. SCL and SDA on the I2C bus can both be connected to the positive supply via a pull-up resistor. When the bus is idle, both lines are high level. When any device on the bus outputs a low level, it causes the bus signal to become low, i.e. a logical "AND" between the signals of multiple devices. This special logical relationship is the key to realizing bus arbitration. The protocol requires the data signal SDA to remain stable while the clock signal SCL is high, and data is usually transmitted in MSB form, as shown in the following figure.

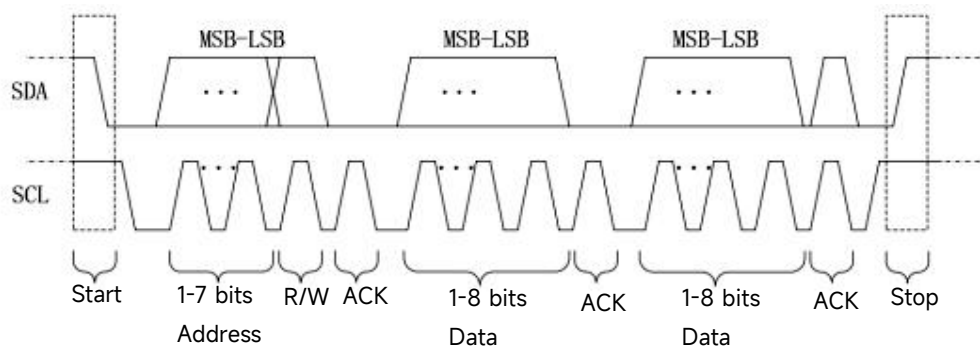

(1) Decoding Menu Setting

a. Protocol Type

Click on the "Protocol Type" to select "I²C".

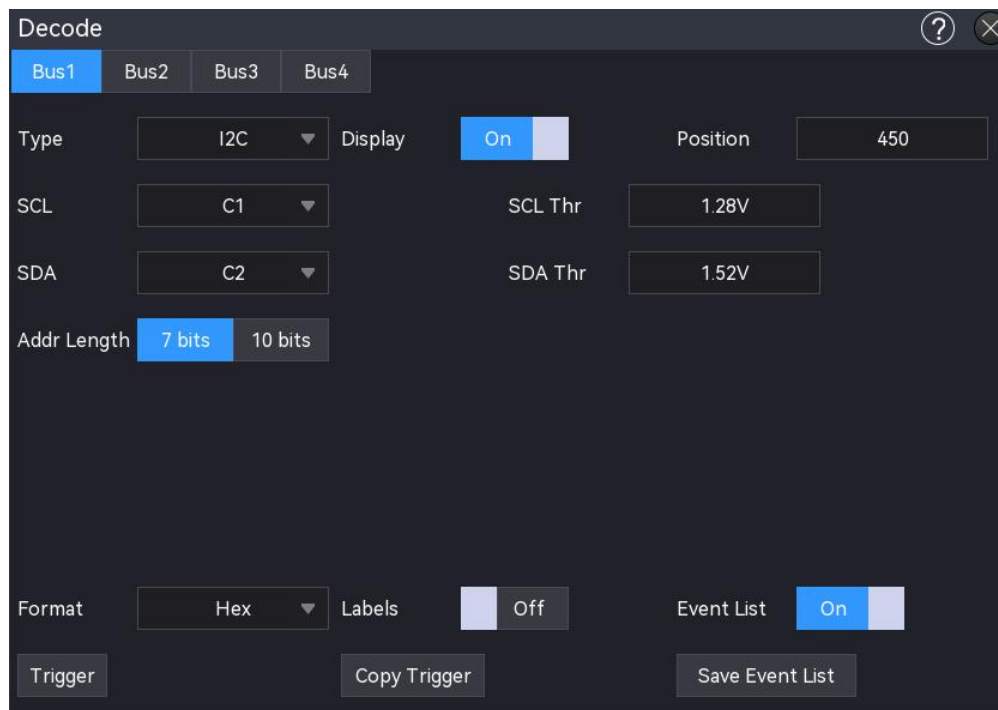

- b. Source Setting

Set the clock source and data source. The source can only trigger stably if the selected channel has a connected signal and is set as the trigger source.

 - Clock Source

Click on the “Clock Source” to select C1-C4 or D0-D15. For more details on *Trigger Source*, refer to the section [Noun Explanation of Triggering System](#). The current source is displayed in the trigger label at the top of the screen.
 - Data Source

Click on the “Data Source” to select C1-C4 or D0-D15. For more details on *Trigger Source*, refer to the section [Noun Explanation of Triggering System](#). The current source is displayed in the trigger label at the top of the screen.
 - c. Threshold Setting

Click to select “SCL threshold, SDA threshold”, and double-click on the “Threshold” input field to open the numeric keypad to set the threshold. Alternatively, rotate the Multipurpose A rotary knob to adjust the threshold.
 - d. Address Length

Set the address bit width of I²C signal, click on the “Address Length” to select 7 bits or 10 bits.
- (2) Decoding Bus Setting
- a. Bus Switch

Click on the “Bus Switch” to switch on/off the bus function.
 - b. Decoding Line

Set the display position of decoding bus on the screen. The display position of decoding line can be adjusted by using Multipurpose A rotary knob. Alternatively, double-click on the “Decoding Line” input field to open the numeric keypad to set the position. The range can be set from 0 to 560.
 - c. Format

Set the display format for the decoding bus and event list decoding. Click on the “Format” to select hexadecimal, decimalism, or binary.
 - d. Label

Click on the “Label” to switch on/off the decoding bus label. When the decoding bus label is switched on, it will display on the left top and display current protocol type. When the decoding bus label is switched off, it will not be displayed.
- (3) Event List
- Click on the “Event List” to switch on/off the event list. When the event list is switched on,

it will be displayed as shown in the following figure. Click the event list icon “x” in the right top to close it.

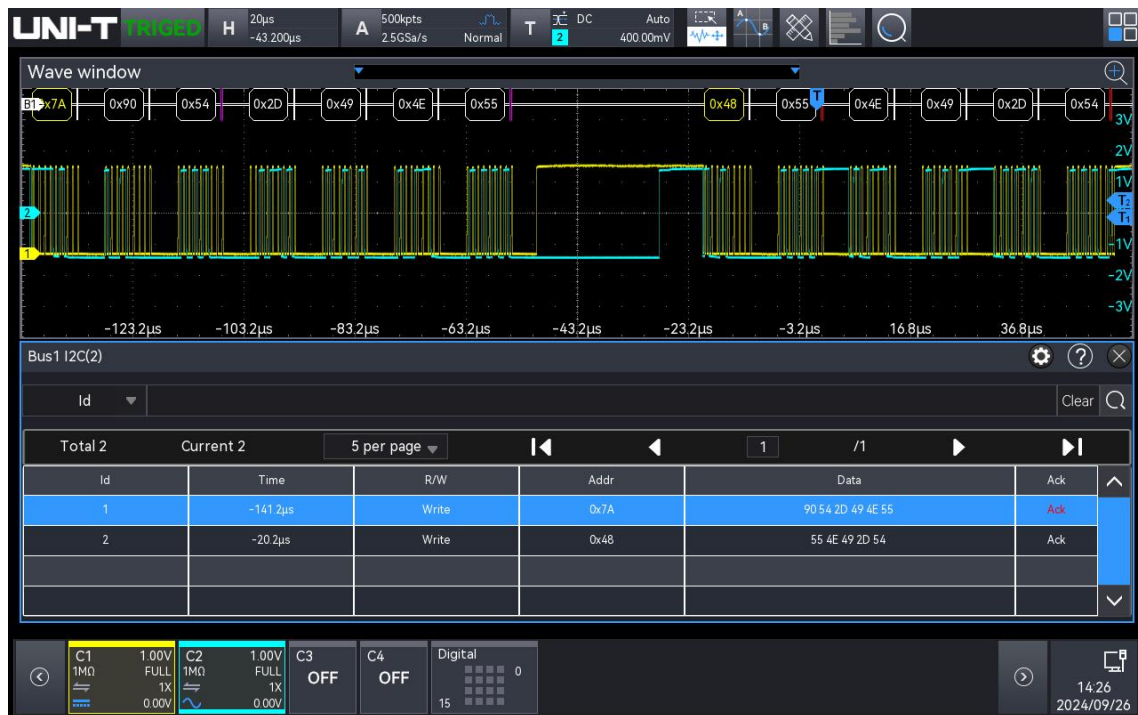

(4) Save Event List

When the operating state is RUN/STOP, the time and decoding data in the current event list can be exported.

Click the “Save Event List” key in the decoding menu to open the export setting menu, the data can be saved in *.csv, *.html, and *.pdf to internal storage or external USB flash drive (when a USB flash drive is detected). For the setting steps, refer to [Save and Load](#) section.

Note: When the operating state is RUN, the decoding data may be unstable, the user can manually stop the oscilloscope to export a stable decoding signal.

(5) Jump to Trigger Menu

Click on the “Trigger” to directly navigate to the trigger menu, where the trigger type is same with the decoding type.

(6) Copy Trigger Settings

When the trigger type and parameter settings are completed, and the decoding type is the same, click on the “Copy trigger” on the decoding page to transfer the parameter settings to the decoding menu.

9.3. SPI Decoding

SPI (Serial Peripheral Interface) allows the host to communicate with peripheral devices in a serial

way. It's full-duplex and synchronous communication bus. It's usually use 4 signal connection line, MOSI: data output from master device, data input from slave device; MISO: data input from master device, data output from slave device; SCLK: clock signal is generated from master device; CS: chip select enable signal from slave device.

The SPI interface is mainly used for synchronous serial data transfer between the host and low-speed peripherals. Data is transferred bit by bit under the shift pulse of the master device, and the transfer format is MSB. SPI interface is widely used because it does not require slave address addressing, it is full duplex communication and the protocol is simple. The transmission of SPI protocol is shown in the following figure

(1) Decoding Menu Setting

a. Protocol Type

Click on the "Protocol Type" to select "SPI".

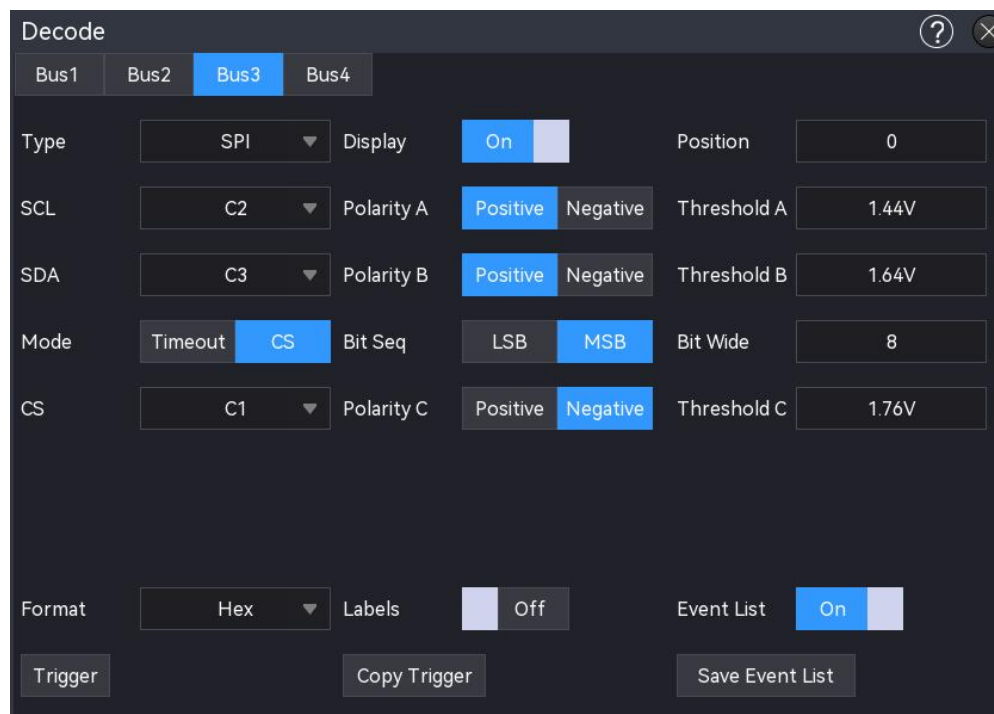

b. Source Setting

Set the clock source, data source and CS source. The source can only trigger stably if the selected channel has a connected signal and is set as the trigger source.

■ Clock Source

Click on the "Clock Source" to select C1-C4 or D0-D15. For more details on *Trigger Source*, refer to the section [Noun Explanation of Triggering System](#). The current source is displayed in the trigger label at the top of the screen.

■ Data Source

Click on the "Data Source" to select C1-C4 or D0-D15. For more details on *Trigger*

Source, refer to the section [Noun Explanation of Triggering System](#). The current source is displayed in the trigger label at the top of the screen.

- Chip Source

Click on the “Chip Source” to select C1-C4 or D0-D15. For more details on *Trigger Source*, refer to the section [Noun Explanation of Triggering System](#). The current source is displayed in the trigger label at the top of the screen.

c. Edge Setting

- Clock Polarity

Click on the “Clock Polarity” to select “Positive” or “Negative”.

Positive: Set to trigger on the positive of clock signal.

Negative: Set to trigger on the negative of clock signal.

- CS Polarity

Click on the “CS Polarity” to select “Positive” or “Negative”.

Positive: It is set to 1 if the signal is greater than the threshold, otherwise, it is 0.

Negative: It is set to 1 if 1 when the signal is less than the threshold, otherwise, it is 0.

- Data polarity

Click on the “Data Polarity” to select “Positive” or “Negative”.

Positive: It is set to 1 if the signal is greater than the threshold, otherwise, it is 0.

Negative: It is set to 1 if 1 when the signal is less than the threshold, otherwise, it is 0.

d. Threshold Setting

Click to select “Threshold A, Threshold B, or Threshold C”, and double-click on the “Threshold” input field to open the numeric keypad to set the threshold. Alternatively, rotate the [Multipurpose A](#) rotary knob to adjust the threshold.

e. Mode

Click on the “Mode” to select SPI. When SPI is selected, timeout and CS menus can be configured.

- Timeout: After the clock signal (CLK) remains idle for the specified time, the oscilloscope triggers when it searches for data that meets the trigger conditions (MISO).

- CS: When the CS is valid, the oscilloscope triggers when it searches for data that meets the trigger conditions (SDA).

f. Bit Sequence

Set the bit sequence for RS232, click on the “Bit Sequence” to select MSB or LSB.

- MSB: The Most Significant Bit, i.e., the bit with the highest value in a sequence, transmitted first.

- LSB: The Least Significant Bit, i.e., the bit with the lowest value in a sequence, transmitted last.
 - g. Bit Width

Set the bit width for each data unit in the SPI protocol signal. Double-click on the “Bit Width” input field to set the bit width. For details on the use of the numeric keypad, refer to the section of [5.8 Parameter Setting](#). Alternatively, select the parameter, use the Multipurpose B rotary knob to move the cursor, and use the Multipurpose A rotary knob to adjust the bit width. The setting range can be set from 4 to 32.
 - h. Timeout

Double-click on the “Timeout” input field to set the timeout. For details on the use of the numeric keypad, refer to the section of [5.8 Parameter Setting](#). Alternatively, select the parameter, use the Multipurpose B rotary knob to move the cursor, and use the Multipurpose A rotary knob to adjust the timeout. The setting range can be set from 99.2 ns to 1 s.
- (2) Decoding Bus Setting
- a. Bus Switch

Click on the “Bus Switch” to switch on/off the bus function.
 - b. Decoding Line

Set the display position of decoding bus on the screen. The display position of decoding line can be adjusted by using Multipurpose A rotary knob. Alternatively, double-click on the “Decoding Line” input field to set the position. The setting range can be set from 0 to 560.
 - c. Format

Set the display format for the decoding bus and event list decoding. Click on the “Format” to select hexadecimal, decimalism, or binary.
 - d. Label

Click on the “Label” to switch on/off the decoding bus label. When the decoding bus label is switched on, it will display on the left top and display current protocol type. When the decoding bus label is switched off, it will not be displayed.
- (3) Event List
- Click on the “Event List” to switch on/off the event list. When the event list is switched on, it will be displayed as shown in the following figure. Click the event list icon “x” in the right top to close it.



(4) Save Event List

When the operating state is RUN/STOP, the time and decoding data in the current event list can be exported.

Click the “Save Event List” key in the decoding menu to open the export setting menu, the data can be saved in *.csv, *.html, and *.pdf to internal storage or external USB flash drive (when a USB flash drive is detected). For the setting steps, refer to [Save and Load](#) section.

Note: When the operating state is RUN, the decoding data may be unstable, the user can manually stop the oscilloscope to export a stable decoding signal.

(5) Jump to Trigger Menu

Click on the “Trigger” to directly navigate to the trigger menu, where the trigger type is same with the decoding type.

(6) Copy Trigger Settings

When the trigger type and parameter settings are completed, and the decoding type is the same, click on the “Copy trigger” on the decoding page to transfer the parameter settings to the decoding menu.

9.4. CAN Decoding

(1) Decoding Menu Setting

a. Protocol Type

Click on the “Protocol Type” to select “CAN”.

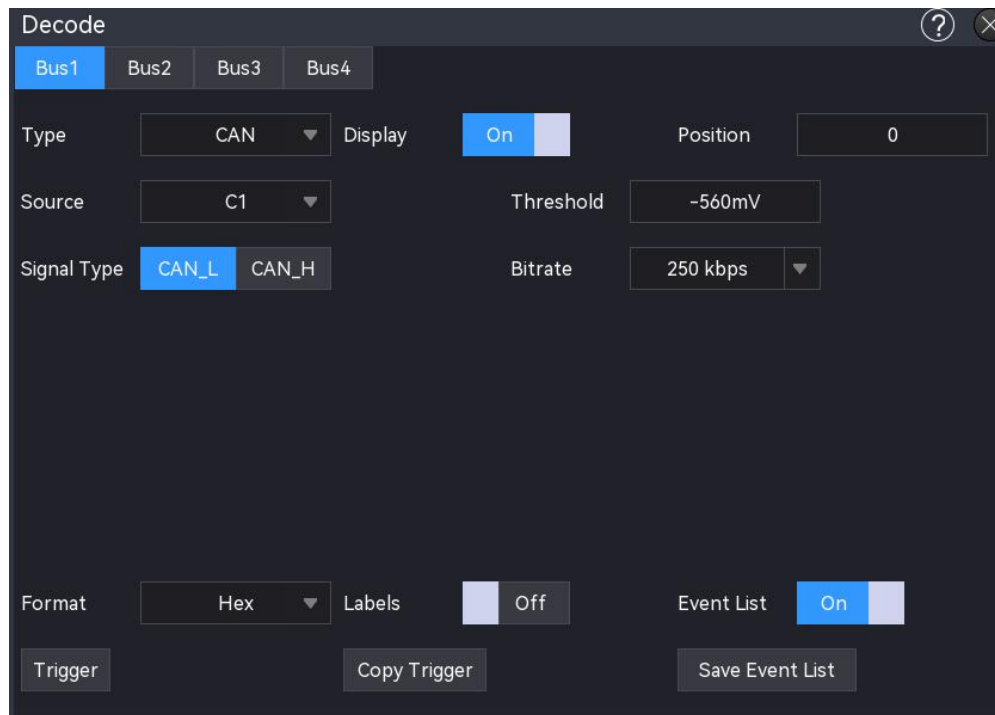

b. Source

Click on the “Source” to select C1-C4 or D0-D15. For more details on *Trigger Source*, refer to the section [Noun Explanation of Triggering System](#). The current source is displayed in the trigger label at the top of the screen.

The source can only trigger stably if the selected channel has a connected signal and is set as the trigger source.

c. Threshold

Double-click on the “Threshold” input field to open the numeric keypad to set the threshold. Alternatively, rotate the [Multipurpose A](#) rotary knob to adjust the threshold.

When the threshold is changed, a dotted line appears on the screen indicating the current trigger level. Once the change is stopped, the dotted line of the threshold disappears after about 2 seconds.

d. Signal Type

Select whether the current signal accessed by the source is a high data line signal or a low data line signal. Click on the “Signal Type” to select “CAN_H”, or “CAN_L”.

e. Bitrate

Select the bitrate for CAN serial bus data. Click on the “Bitrate” to select 10 kbps, 19.2 kbps, 20 kbps, 33.3 kbps, 38.4 kbps, 50 kbps, 57.6 kbps, 62.5 kbps, 83.3 kbps, 100 kbps, 115.2 kbps, 125 kbps, 230.4 kbps, 250 kbps, 490.8 kbps, 500 kbps, 800 kbps, 921.6 kbps, 1 Mbps, 2 Mbps, 3 Mbps, 4 Mbps, 5 Mbps, or a custom bitrate.

If "Custom" is selected, a custom bitrate can be entered.

(2) Decoding Bus Setting

a. Bus Switch

Click on the "Bus Switch" to switch on/off the bus function.

b. Decoding Line

Set the display position of decoding bus on the screen. The display position of decoding line can be adjusted by using Multipurpose A rotary knob. Alternatively, double-click on the "Decoding Line" input field to set the position. The setting range can be set from 0 to 560.

c. Format

Set the display format for the decoding bus and event list decoding. Click on the "Format" to select hexadecimal, decimalism, binary, or ASCII.

d. Label

Click on the "Label" to switch on/off the decoding bus label. When the decoding bus label is switched on, it will display on the left top and display the current protocol type. When the decoding bus label is switched off, it will not be displayed.

(3) Event List

Click on the "Event List" to switch on/off the event list. When the event list is switched on, it will be displayed as shown in the following figure. Click the event list icon "x" in the right top to close it.



(4) Save Event List

When the operating state is RUN/STOP, the time and decoding data in the current event list can be exported.

Click the “Save Event List” key in the decoding menu to open the export setting menu, the data can be saved in *.csv, *.html, and *.pdf to internal storage or external USB flash drive (when a USB flash drive is detected). For the setting steps, refer to [Save and Load](#) section.

Note: When the operating state is RUN, the decoding data may be unstable, the user can manually stop the oscilloscope to export a stable decoding signal.

(5) Jump to Trigger Menu

Click on the “Trigger” to directly navigate to the trigger menu, where the trigger type is same with the decoding type.

(6) Copy Trigger Settings

When the trigger type and parameter settings are completed, and the decoding type is the same, click on the “Copy trigger” on the decoding page to transfer the parameter settings to the decoding menu.

9.5. CAN-FD Decoding

(1) Decoding Menu Setting

a. Protocol Type

Click on the “Protocol Type” to select “CAN-FD”.

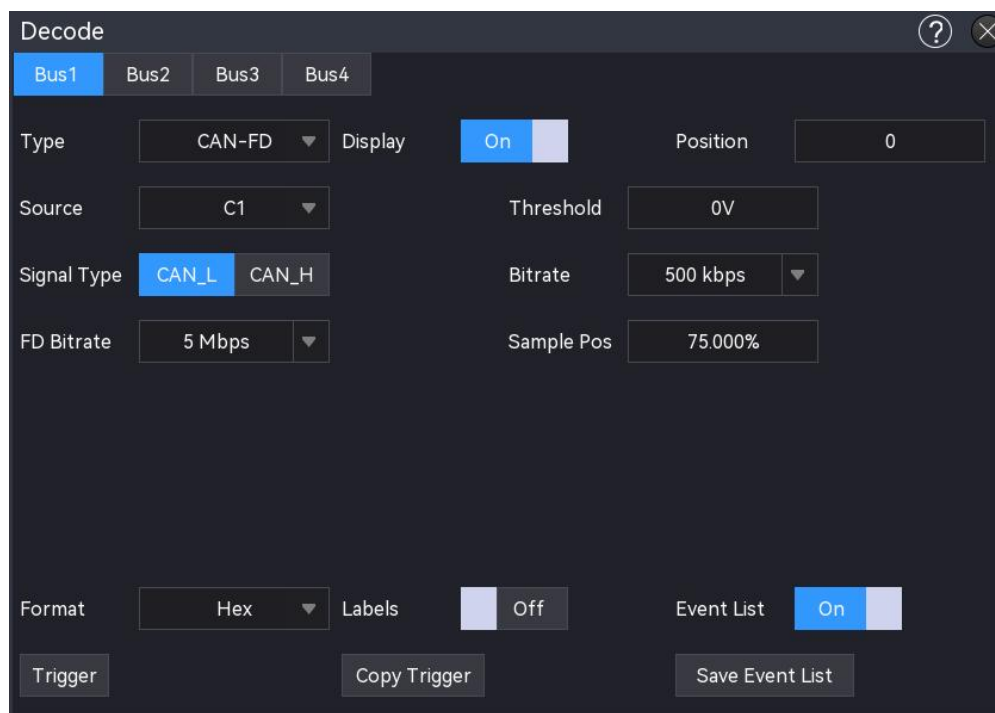

b. Source

Click on the “Source” to select C1-C4 or D0-D15. For more details on *Trigger Source*, refer to the section [Noun Explanation of Triggering System](#). The current source is displayed in the trigger label at the top of the screen.

The source can only trigger stably if the selected channel has a connected signal and is set as the trigger source.

c. Threshold

Double-click on the “Threshold” input field to open the numeric keypad to set the threshold. Alternatively, rotate the [Multipurpose A](#) rotary knob to adjust the threshold.

When the threshold is changed, a dotted line appears on the screen indicating the current threshold. If the change is stopped, the dotted line of the threshold disappears after about 2 seconds.

d. Signal Type

Select whether the current signal accessed by the source is a high data line signal or a low data line signal. Click on the “Signal Type” to select “CAN_H” or “CAN_L”.

e. Bitrate

Select the bitrate for CAN-FD serial bus data. Click on the “Bitrate” to select 10 kbps, 19.2 kbps, 20 kbps, 33.3 kbps, 38.4 kbps, 50 kbps, 57.6 kbps, 62.5 kbps, 83.3 kbps, 100 kbps, 115.2 kbps, 125 kbps, 230.4 kbps, 250 kbps, 490.8 kbps, 500 kbps, 800 kbps, 921.6 kbps, 1 Mbps, 2 Mbps, 3 Mbps, 4 Mbps, 5 Mbps, or a custom bitrate.

If "Custom" is selected, a custom bitrate can be entered.

f. FD Bitrate

Select the FD bitrate for CAN-FD serial bus data, click on the “Bitrate” to select 250 kbps, 500 kbps, 800 kbps, 1 Mbps, 1.5 Mbps, 2 Mbps, 4 Mbps, 6 Mbps, 8 Mbps or a custom bitrate.

g. Sampling Position

The sample position is the point in the bit time where the oscilloscope samples the bit level. The sample position is expressed as a percentage of the "Time from bit start to sample point" and the "Bit Time".

Click on the “Sampling Position” input field to open the numeric keypad to set the sampling position. Alternatively, rotate the [Multipurpose A](#) rotary knob to adjust the sampling position. The range can be set from 30% to 90%.

(2) Decoding Bus Setting

a. Bus Switch

Click on the “Bus Switch” to switch on/off the bus function.

b. Decoding Line

Set the display position of decoding bus on the screen. The display position of decoding line can be adjusted by using Multipurpose A rotary knob. Alternatively, double-click on the “Decoding Line” input field to set the position. The setting range can be set from 0 to 560.

c. Format

Set the display format for the decoding bus and event list decoding. Click on the “Format” to select hexadecimal, decimalism, binary, or ASCII.

d. Label

Click on the “Label” to switch on/off the decoding bus label. When the decoding bus label is switched on, it will display on the left top and display the current protocol type. When the decoding bus label is switched off, it will not be displayed.

(3) Event List

Click on the “Event List” to switch on/off the event list. When the event list is switched on, it will be displayed as shown in the following figure. Click the event list icon “x” in the right top to close it.



(4) Save Event List

When the operating state is RUN/STOP, the time and decoding data in the current event list can be exported.

Click the “Save Event List” key in the decoding menu to open the export setting menu, the data can be saved in *.csv, *.html, and *.pdf to internal storage or external USB flash drive (when a

USB flash drive is detected). For the setting steps, refer to [Save and Load](#) section.

Note: When the operating state is RUN, the decoding data may be unstable, the user can manually stop the oscilloscope to export a stable decoding signal.

(5) Jump to Trigger Menu

Click on the “Trigger” to directly navigate to the trigger menu, where the trigger type is same with the decoding type.

(6) Copy Trigger Settings

When the trigger type and parameter settings are completed, and the decoding type is the same, click on the “Copy trigger” on the decoding page to transfer the parameter settings to the decoding menu.

9.6. LIN Decoding

(1) Decoding Menu Setting

a. Protocol Type

Click on the “Protocol Type” to select “LIN”.

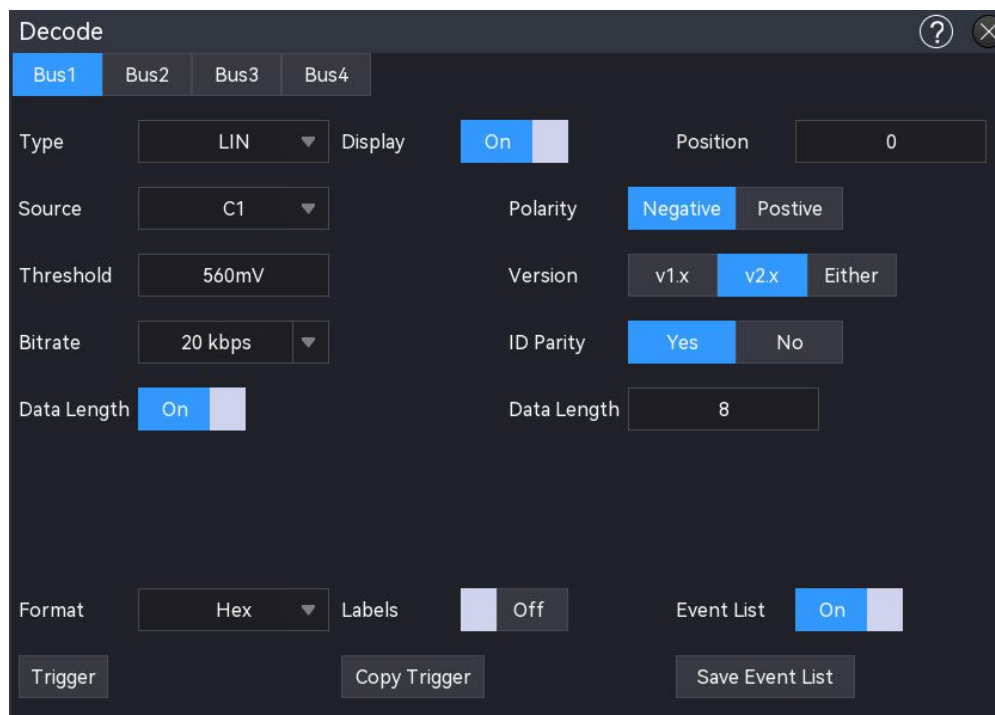

b. Source

Click on the “Source” to select C1-C4 or D0-D15. For more details on *Trigger Source*, refer to the section [Noun Explanation of Triggering System](#). The current source is displayed in the trigger label at the top of the screen.

The source can only trigger stably if the selected channel has a connected signal and is set

- as the trigger source.
- c. Polarity
Click on the "Polarity" to select the polarity to "Normal (high=1)" or "Reverse (high=0)".
 - d. Threshold
Double-click on "Threshold" input field to open the numeric keypad to set the threshold.
Alternatively, rotate the Multipurpose A rotary knob to adjust the threshold.
When the threshold is changed, a dotted line appears on the screen indicating the current threshold. If the change is stopped, the dotted line of the threshold disappears after about 2 seconds.
 - e. Version
Click on the "Version" to select the signal version to v1.x, v2.x, or arbitrary.
 - f. Bitrate
Select the bitrate for LIN, click on the "Bitrate" to select 1.2 kbps, 2.4 kbps, 4.8 kbps, 9.6 kbps, 10.417 kbps, 19.2 kbps, 20 kbps, or a custom bitrate.
If "Custom" is selected, a custom bitrate can be entered.
 - g. ID Parity check
Set ID Parity check to toggle it ON or OFF.
ON: Includes parity bit and ID.
OFF: Does not include parity bit and ID.
 - h. Data Length Menu
Set whether to display the data length menu, click on the "Data Length" to toggle it ON or OFF.
ON: Displays the data length menu.
OFF: Hide the data length menu.
 - i. Data Length
Set LIN data length, double-click on the "Data Length" input field to open the numeric keypad to set the data length. For details on the use of the numeric keypad, refer to the section of [5.8 Parameter Setting](#). Alternatively, select the parameter, use the Multipurpose B rotary knob to move the cursor, and use the Multipurpose A rotary knob to adjust the data length. The data length can be set from 1 to 8. It is only available when the data length menu is displayed.
- (2) Decoding Bus Setting
- a. Bus Switch
Click on the "Bus Switch" to switch on/off the bus function.
 - b. Decoding Line

Set the display position of decoding bus on the screen. The display position of decoding line can be adjusted by using Multipurpose A rotary knob. Alternatively, double-click on the “Decoding Line” input field to set the position. The setting range can be set from 0 to 560.

c. Format

Set the display format for the decoding bus and event list decoding. Click on the “Format” to select hexadecimal, decimalism, or binary.

d. Label

Click on the “Label” to switch on/off the decoding bus label. When the decoding bus label is switched on, it will display on the left top and display the current protocol type. When the decoding bus label is switched off, it will not be displayed.

(3) Event List

Click on the “Event List” to switch on/off the event list. When the event list is switched on, it will be displayed as shown in the following figure. Click the event list icon “x” in the right top to close it.



(4) Save Event List

When the operating state is RUN/STOP, the time and decoding data in the current event list can be exported.

Click the “Save Event List” key in the decoding menu to open the export setting menu, the data can be saved in *.csv, *.html, and *.pdf to internal storage or external USB flash drive (when a USB flash drive is detected). For the setting steps, refer to [Save and Load](#) section.

Note: When the operating state is RUN, the decoding data may be unstable, the user can

manually stop the oscilloscope to export a stable decoding signal.

(5) Jump to Trigger Menu

Click on the “Trigger” to directly navigate to the trigger menu, where the trigger type is same with the decoding type.

(6) Copy Trigger Settings

When the trigger type and parameter settings are completed, and the decoding type is the same, click on the “Copy trigger” on the decoding page to transfer the parameter settings to the decoding menu.

9.7. Audio Decoding

Audio (Inter—IC Sound) bus, also known as the Integrated Circuit Built-in Audio Bus, is a bus standard developed by Philips for the transmission of audio data between digital audio devices.

(1) Decoding Menu Setting

a. Protocol Type

Click on the “Protocol Type” to select “Audio”.

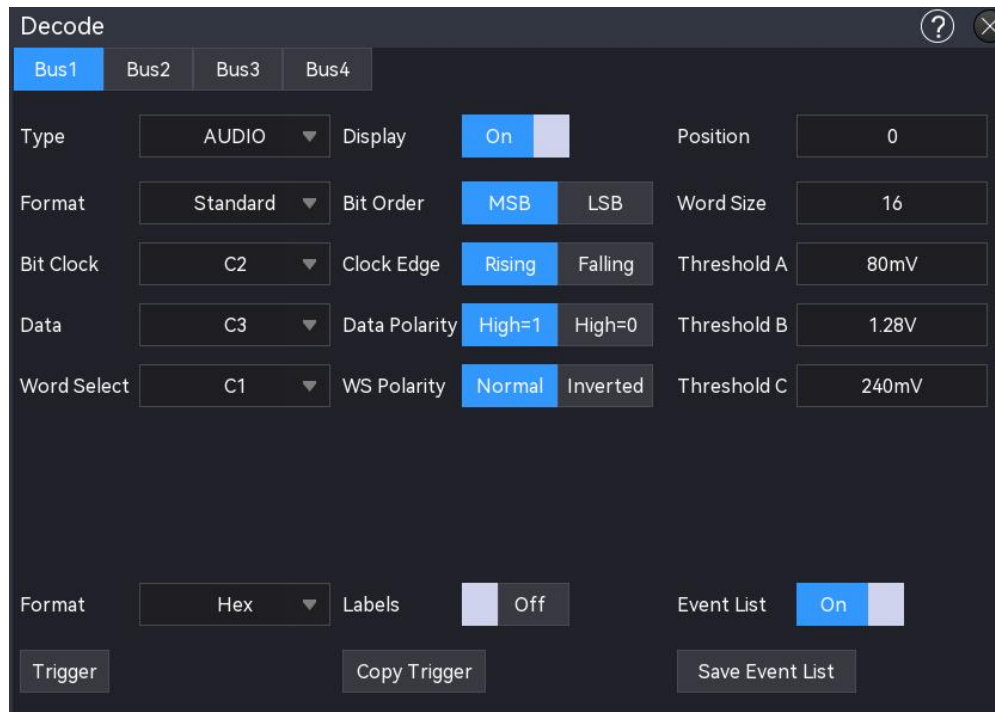

b. Format

Click on the “Format” to select standard, left justifying, right justifying, or TDM.

- Standard: MSB of each sampled data is sent first and the LSB is sent last. MSB is displayed on the SDATA line, which at one clock bit clock after the edge of WS transition.

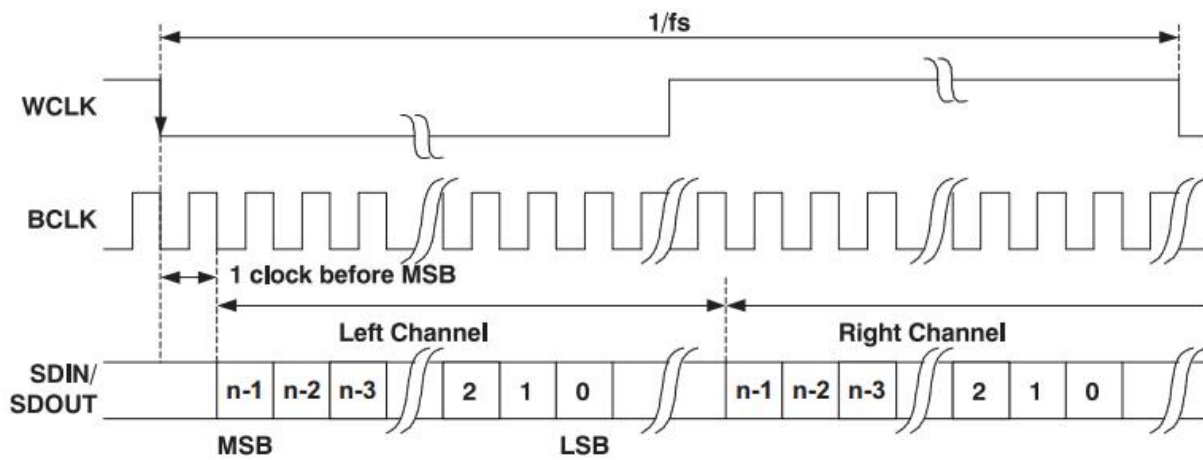

- Left justifying: Data transmission (MSB first) starts at the edge of the WS conversion (without the one-bit delay used by the standard format).

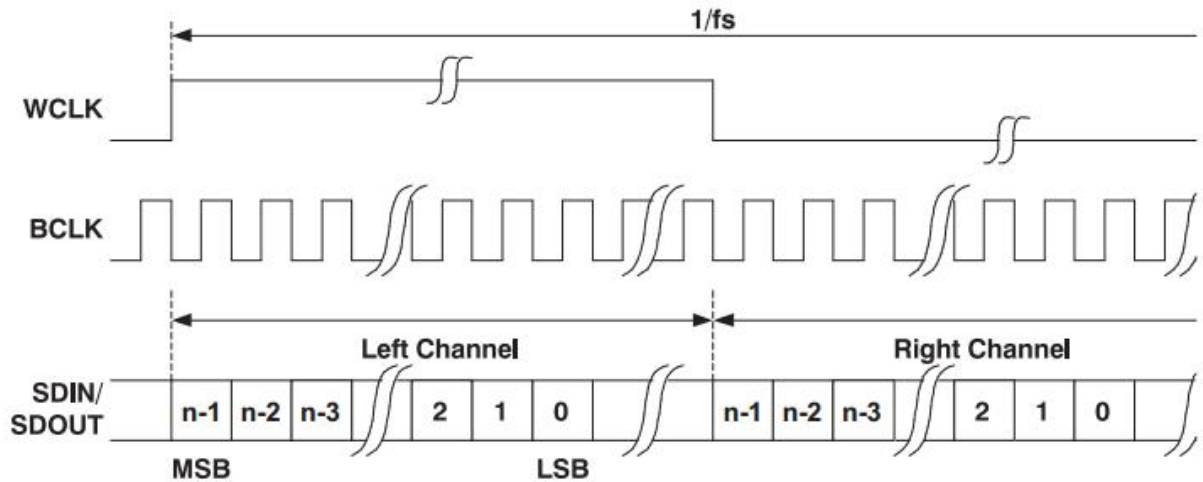

- Right justifying: Data transmission (MSB first) is right justifying with WS.

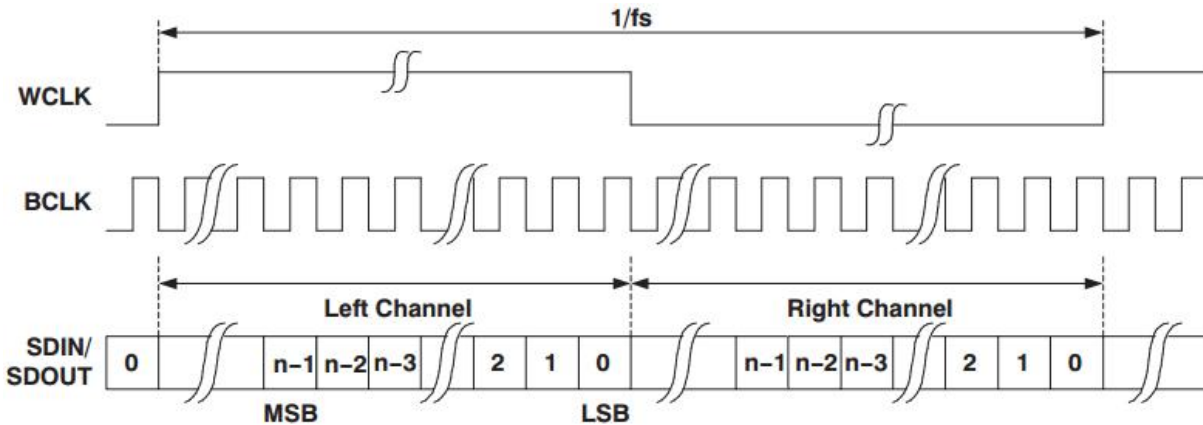

- TDM: (Time Division Multiplexing) mode can transmit multi-channel data.

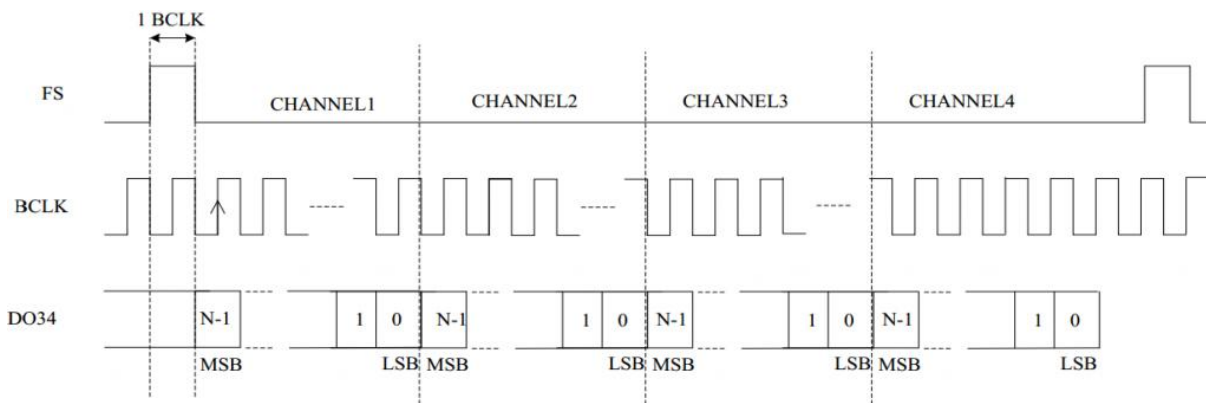

c. Bit Sequence

Click on the “Bit Sequence” to select “LSB” or “MSB”. The default is “MSB”.

d. Source Setting

Set the bit clock, bit selection and data source. The source can only trigger stably if the selected channel has a connected signal and is set as the trigger source.

■ Bit Clock

Click on the “Bit Clock” to select C1-C4 or D0-D15. For more details on *Trigger Source*, refer to the section [Noun Explanation of Triggering System](#). The current source is displayed in the trigger label at the top of the screen. The clock line (SCLK) provides the clock signal for synchronizing audio data transmission.

■ Bit Selection

Click on the “Bit Selection” to select C1-C4 or D0-D15. For more details on *Trigger Source*, refer to the section [Noun Explanation of Triggering System](#). The current source is displayed in the trigger label at the top of the screen.

The bit selection indicates the audio data of the current transmission is left channel or right channel.

■ Data

Click on the “Data” to select C1-C4 or D0-D15. For more details on *Trigger Source*, refer to the section [Noun Explanation of Triggering System](#). The current source is displayed in the trigger label at the top of the screen. The data line is used to transmit the actual audio data.

■ Frame Synchronization

Click on the “Frame Synchronization” to select C1-C4 or D0-D15. For more details on *Trigger Source*, refer to the section [Noun Explanation of Triggering System](#). The current source is displayed in the trigger label at the top of the screen.

e. Edge Setting

■ Clock Edge

Click on the “Clock” to select “Rising/Falling” edge.

Rising edge: Samples SDA on the rising edge of clock.

Falling edge: Samples SDA on the falling edge of clock.

■ WS Polarity

Click on the “WS Polarity” to select “Normal” or “Reverse”. The WS polarity determines the valid level for the bit selection signal. The bit selection signal indicates the start frame and end of frame for the audio data.

■ Data Polarity

Click on the “Data Polarity” to select “high=1” or “high=0”.

■ Polarity Synchronization

Click on the “Polarity Synchronization” to set the edge for signal synchronization, which can set to “Rising” or “Falling” edge.

f. Threshold

Click to select the threshold of the corresponding source and change the threshold.

Double-click on the “Threshold” input field to open the numeric keypad to set the threshold.

For details on the use of the numeric keypad, refer to the section of [5.8 Parameter Setting](#).

Alternatively, select the parameter, use the Multipurpose A to adjust the threshold.

g. Bit Size

The bit size can be set when the format is standard, left justifying or right justifying.

Double-click on the “Bit Size” input field to open the numeric keypad to set the bit size. For details on the use of the numeric keypad, refer to the section of [5.8 Parameter Setting](#).

Alternatively, select the parameter, use the Multipurpose A to adjust the bit size. The setting range can be set from 4 to 32.

h. Data Bit of Each Channel

Double-click on the “Data Bit of Each Channel” input field to pop up the numeric keyboard to set this value. For details on the use of the numeric keyboard, refer to the section of [5.8 Parameter Setting](#). Select this parameter and use the Multipurpose rotary knob to change this value. The range of data bit can be set from 4 to 32.

Data bit setting for each channel \leq Clock bit setting for each channel

i. Clock Bit of Each Channel

Double-click on the “Clock Bit of Each Channel” input field to pop up the numeric keyboard to set this value. For details on the use of the numeric keyboard, refer to the section of [5.8 Parameter Setting](#). Select this parameter and use the Multipurpose rotary knob to change this value. The range of clock bit can be set from 4 to 32.

j. Frame of Each Channel

Double-click on the “Frame of Each Channel” input field to pop up the numeric keyboard to set this value. For details on the use of the numeric keyboard, refer to the section of [5.8 Parameter Setting](#). Select this parameter and use the Multipurpose rotary knob to change this value. The range of frames can be set from 2 to 64.

k. Bit Delay

Double-click on the “Bit Delay” input field to pop up the numeric keyboard to set this value. For details on the use of the numeric keyboard, refer to the section of [5.8 Parameter Setting](#). Select this parameter and use the Multipurpose rotary knob to change this value. The range of bit delay can be set from 0 to 31.

Bit delay < Clock bit setting for each channel

(2) Decoding Bus Setting

a. Bus Switch

Click on the “Bus Switch” to switch on/off the bus function.

b. Decoding Line

Set the display position of decoding bus on the screen. The display position of decoding line can be adjusted by using Multipurpose A rotary knob. Alternatively, double-click on the “Decoding Line” input field to set the position. The setting range can be set from 0 to 560.

c. Format

Set the display format for the decoding bus and event list decoding. Click on the “Format” to select hexadecimal, decimalism, or binary.

d. Label

Click on the “Label” to switch on/off the decoding bus label. When the decoding bus label is switched on, it will display on the left top and display the current protocol type. When the decoding bus label is switched off, it will not be displayed.

(3) Event List

Click on the “Event List” to switch on/off the event list. When the event list is switched on, it will be displayed as shown in the following figure. Click the event list icon “x” in the right top to close it.



(4) Save Event List

When the operating state is RUN/STOP, the time and decoding data in the current event list can be exported.

Click the “Save Event List” key in the decoding menu to open the export setting menu, the data can be saved in *.csv, *.html, and *.pdf to internal storage or external USB flash drive (when a USB flash drive is detected). For the setting steps, refer to [Save and Load](#) section.

Note: When the operating state is RUN, the decoding data may be unstable, the user can manually stop the oscilloscope to export a stable decoding signal.

(5) Jump to Trigger Menu

Click on the “Trigger” to directly navigate to the trigger menu, where the trigger type is same with the decoding type.

(6) Copy Trigger Settings



When the trigger type and parameter settings are completed, and the decoding type is the same, click on the “Copy trigger” on the decoding page to transfer the parameter settings to the decoding menu.

10. Automatic Measurement

- [Parameter Measurement Overview](#)
- [Counter](#)
- [Voltmeter](#)
- [Parameter Snapshot](#)
- [Parameter Measurement](#)
- [Measurement Statistics](#)
- [Add Parameter](#)
- [Clear Added Measurement](#)
- [Global Setting](#)

MSO1000HD series measurement menu can access all parameter measurement menu, including parameter snapshots, custom parameters, parameter statistics, counters, voltmeters, etc., as well as global settings for parameter measurements.

The “Measure” menu can be entered using the following steps.

- Press the Measure key on the front panel to enter the “Measure” menu.
- Click the Home icon  in the top right corner and select the measurement icon  to enter the “Measure” menu.
- If the measurement is added to the toolbar, click the measurement icon  in the toolbar in the top right corner to enter the “Measure” menu.

10.1. Parameter Measurement Overview

MSO1000HD series oscilloscope can automatically measure 56 kinds of parameter, such as voltage, time, and other parameters.

■ Voltage Parameter

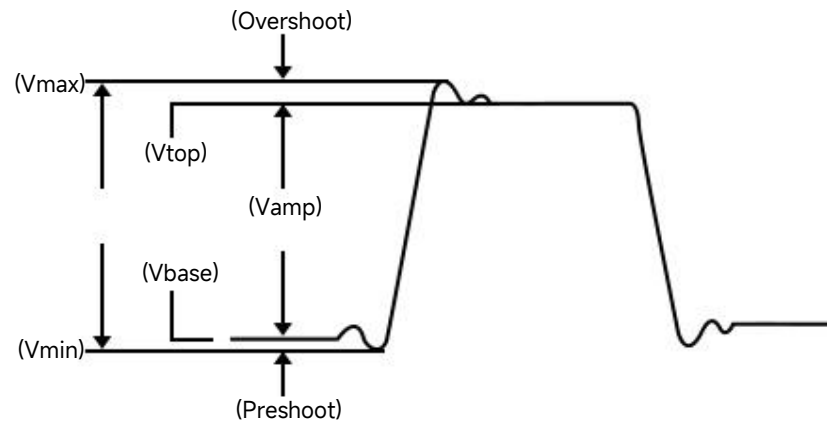

Maximum (V_{max}): The voltage from the highest point of the waveform to GND.

Minimum (V_{min}): The voltage from the lowest point of the waveform to GND.

Top (V_{top}): The voltage value from the flat top of the waveform to GND.

Bottom (V_{base}): The voltage value from the bottom of the waveform to GND.

Middle: Half of the sum of the voltage values at the top and bottom of the waveform

Peak-to-peak (V_{pp}): The voltage value from the highest point to the lowest point of the waveform.

Amplitude (V_{amp}): The voltage from top to bottom of the waveform.

Average (Mean): The average amplitude of the waveform in one cycle.

Root mean square (RMS): The energy generated by the conversion of AC signal; it corresponds to the DC voltage that generates equivalent energy.

RMS of cycle (CycRMS): The energy generated by the conversion of AC signal in one cycle, it corresponds to the DC voltage that generates equivalent energy.

AC RMS of cycle: Standard deviation of voltage value of waveform data in one cycle, which DC component has removed.

Area: The algebraic sum of the product of voltage and time for all points on the screen

Cycle area: The algebraic sum of the product of the voltage and the time at all the points in a cycle of the waveform.

Positive area: The algebraic sum of the product of all voltages and times on the screen greater than GND (ground).

Negative area: The algebraic sum of the product of all voltages and times on the screen less than GND (ground).

Positive cycle area: The algebraic sum of the product of all voltages and times greater than GND (ground) in a cycle.

Negative cycle area: The algebraic sum of the product of all voltages and times less than GND

(ground) in a cycle.

Positive overshoot: The nearest extreme point after the signal along the rising edge of the waveform crosses the upper threshold limit.

Negative overshoot: The nearest extreme point after the signal along the falling edge of the waveform crosses the lower threshold limit.

Positive pre-shoot: The nearest extreme point before the signal along the rising edge of the waveform crosses the upper threshold limit.

Negative pre-shoot: The nearest extreme point before the signal along the falling edge of the waveform crosses the lower threshold limit.

■ Time Parameter

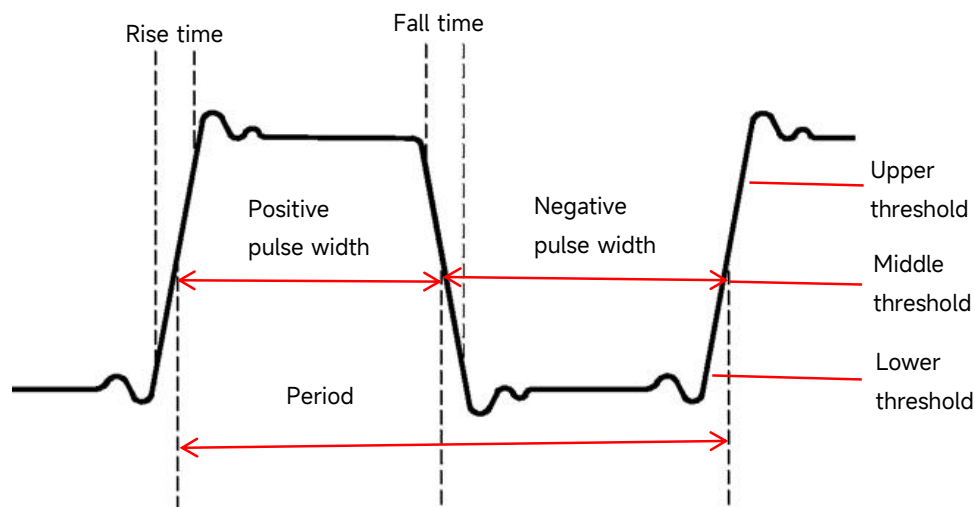

Period: The time between two consecutive, homopolar edges of a repetitive waveform with the same threshold median crossing point.

Frequency: The reciprocal of the cycle

Rise time: Time needed for waveform amplitude rising from the lower threshold to the upper threshold.

Fall time: Time needed for waveform amplitude rising from the upper threshold to the lower threshold.

Positive pulse width: The time difference between the time at the middle threshold on the rising edge of the pulse and the time at the middle threshold on the falling edge of the pulse immediately following.

Negative pulse width: The time difference between the time at the middle threshold on the falling edge of the pulse and the time at the middle threshold on the rising edge of the pulse immediately following.

Positive duty ratio: The ratio of the positive pulse width to period.

Negative duty ratio: The ratio of the negative pulse width to period.

Positive pulse number: The number of positive pulses from the lower threshold to the upper threshold.

Negative pulse number: The number of negative pulses from the upper threshold to the lower threshold.

Rising edge number: The number of rising edges from the lower threshold to the upper threshold.

Falling edge number: The number of falling edges from the upper threshold to the lower threshold.

Burst width: Length of time that the intermediate reference level is exceeded more than once in a row.

Burst interval: The interval between two burst events.

Burst period: Burst period that satisfy burst width and burst interval.

Burst period number: The number that satisfies burst period.

■ Other Parameters

Ratio: The ratio of the AC effective voltages of the master and slave sources, expressed in dB.

Period ratio: The ratio of the periodic AC RMS voltages of the master and slave sources, expressed in dB.

Setup time: The time from when the specified intermediate reference level on the data source was exceeded to the last time the specified intermediate reference level on the clock source was exceeded.

Hold time: The time from when the specified intermediate reference level on the clock source was exceeded to the last time the specified intermediate reference level on the data source was exceeded.

Setup and Hold ratio: The ratio of the total time of setup time and hold time

FRFR: Time at the middle threshold intersection from the first rising edge of source 1 to the first rising edge of source 2.

FRFF: Time at the middle threshold intersection from the first rising edge of source 1 to the first falling edge of source 2.

FFFR: Time at the middle threshold intersection from the first falling edge of source 1 to the first rising edge of source 2.

FFFF: Time at the middle threshold intersection from the first falling edge of source 1 to the first falling edge of source 2.

FRLF: Time at the middle threshold intersection from the first rising edge of source 1 to the last falling edge of source 2.

FRLR: Time at the middle threshold intersection from the first rising edge of source 1 to the last rising edge of source 2.

FFLR: Time at the middle threshold intersection from the first falling edge of source 1 to the last rising edge of source 2.

FFLF: Time at the middle threshold intersection from the first falling edge of source 1 to the last falling edge of source 2.

Phase (r-r): The phase offset between the rising edge of the master source and the rising edge of the slave source at the median waveform threshold, expressed in degrees.

Phase (f-f): The phase offset between the falling edge of the master source and the falling edge of the slave source at the median waveform threshold, expressed in degrees.

Delay (r-r) : The delay time between the rising edge of the master source and the rising edge of the slave signal source at the median value of the waveform threshold.

Delay (f-f) : The delay time between the falling edge of the master source and the falling edge of the slave signal source at the median value of the waveform threshold.

■ Power Analysis

- Power quality parameters

Voltage peak: The maximum value of the voltage waveform.

Voltage RMS: The root mean square (RMS) value of the voltage waveform.

Peak voltage factor: The ratio of the peak value to the RMS value of the voltage waveform.

Current peak: The maximum value of the current waveform.

Current RMS: The root mean square (RMS) value of the current waveform.

Current peak factor: The ratio of the peak value of the current waveform to its RMS value.

Active power: The power actually consumed by the load, measured in watts (W).

Reactive power: The power due to inductance and capacitance in a circuit, measured in volt-amperes reactive (var).

Apparent power: The product of the RMS values of voltage and current, measured in volt-amperes (VA).

Power factor: The ratio of active power to apparent power.

Power phase angle: The angle between active power and apparent power, measured in degrees (°).

- Surge current parameters

Surge current: The peak current flows into the power supply equipment at the moment the



power supply is turned on.

Note: Parameters in the power quality category can only be customized after the power quality Analysis is enabled.

10.2. Counter

The counter analysis function provides counting measurements of frequency, period or product on any analogue channel.

The counter function can be entered using the following steps.

- Press the **Measure** key on the front panel, click on the “Counter” in the “Measure” menu to open the counter analysis function.
- Press the **Analyze** key on the front panel, click on the “Counter” in the “Analyze” menu to open the counter analysis function.
- Click the Home icon in the top right corner and select the counter icon  to open the counter box to switch on the counter analysis function.
- Click the counter icon  in the toolbar in the top right corner, to open the counter box to switch on the counter analysis function.

The results of count measurement are displayed above the volts/div box. Counter analysis can be used for multiple channels.



(1) Counter Setting

Once the counter is enabled, tap the counter parameter to open the counter box to set the

display state, source, test type, refresh time, effective digit, and clear count.

a. Display State

Click on the “Display” to switch on/off the counter display.

ON: The result of count measurement will be displayed at the bottom of the screen.

b. Source

Click on the “Source” to select the source to be tested. C1-C4 and the trigger source can both serve as the source for the counter.

c. Test Type

Select the “Frequency”, “Period”, or “Accumulation” parameter to be tested. “Accumulation” is the counting of signal edge events.

d. Refresh Time

Set the refresh time for the results of count measurement. Click on the “Refresh Time” input field to rotate the Multipurpose A rotary knob to change the time; or double-click on the “Refresh time” input field to open the numeric keypad to set the time. The time range can be set from 200 ms to 10 s.

e. Effective Digit

The display bit of the counter measured results can be set in the “Frequency”, “Period” parameter. Click on the “Effective digit” input field to rotate the Multipurpose A rotary knob to change the effective digit; or double-click on the “Effective digit” input field to open the numeric keypad to set the effective digit. The range of effective digit can be set from 3 to 7.

f. Clear Count



If the “Accumulation” is selected and the count of signal edge event is being measured, click on the “Clear Count” to delete the count results and restart the count measurement.

10.3. Voltmeter

The built-in digital voltmeter (DVM) of this oscilloscope can measure 4 effective digits of voltage on any analogue channel. DVM measurements are asynchronous to the oscilloscope's acquisition system and are always acquired.

DVM measurement can be entered using the following steps.

- Press the Measure key on the front panel, click on the “Voltmeter” in the “Measure” menu to open the voltmeter measurement.
- Press the Analyze key on the front panel, click on the “Voltmeter” in the “Analyze” menu to open the voltmeter measurement.

- Click the Home icon in the top right corner and select the voltmeter icon  to open the voltmeter box to switch on the voltmeter measurement.
- Click the voltmeter icon  in the toolbar in the top right corner, to open the voltmeter box to switch on the voltmeter measurement.

The results of voltmeter measurement are displayed above the volts/div box. Voltmeter measurement can be used for multiple channels.



(1) Voltmeter Setting

Once the voltmeter is enabled, tap the voltmeter parameter to open the voltmeter box to set the display state, source, test type, refresh time, and beep.

a. Display State

Click on the “Display” to switch on/off the voltmeter display.

ON: The result of voltmeter measurement will be displayed at the bottom of the screen.

b. Source

Click on the “Source” to select the source to be tested. C1-C4 and the trigger source can both serve as the source for the counter. DVM measurement can be performed even if C1-C4 is not open.

c. Test Type

- DC: Displays the average of the collected data.
- AC RMS: Displays RMS of the collected data that the DC component has removed.
- DC+AC RMS: Displays RMS of the collected data.

d. Refresh Time

Set the refresh time for the results of count measurement. Click on the “Refresh Time” input field to rotate the Multipurpose A rotary knob to change the time; or double-click on the “Refresh Time” input field to open the numeric keypad to set the time. The time range can be set from 200 ms to 10 s.

(2) Beep Setting

Set the display state, limit condition, and the lower/upper limit for the beep.

a. Display State

Click on the “Display” to switch on/off the beep.

ON: The oscilloscope will have an alarm if the test result meets the condition, otherwise, the alarm will not be sound.

b. Limit Condition

- >: The oscilloscope will have an alarm if the DVM value is greater than the set lower limit, and the lower limit can be set.

- <: The oscilloscope will have an alarm if the DVM value is less than the set upper limit, and the upper limit can be set.

- <>: The oscilloscope will have an alarm if the DVM value is greater than the set lower limit and less than the set upper limit, and the upper/lower limit can be set.

- ><: The oscilloscope will have an alarm if the DVM value is less than the set lower limit and greater than the set upper limit, and the upper/lower limit can be set.

c. Upper/Lower Limit

The set voltage is compared to DVM value, and the range can be set from -500 V to 500 V.

- When the trigger condition is “>” or “<”, click on the “Lower” or “Upper” input field to open the numeric keypad to set the lower/upper limit. Alternatively, rotate the Multipurpose A rotary knob to change the lower/upper limit.

- When the trigger condition is “<>” or “><” click on the “Lower” or “Upper” input field to open the numeric keypad to set the lower/upper limit. Alternatively, rotate the Multipurpose A rotary knob to change the lower/upper limit. The lower limit should be less than the upper limit.

10.4. Parameter Snapshot

The parameter snapshot is used to display one parameter that has performed an automatic measurement.

Press the **Measure** key on the front panel, click on the “Parameter snapshot” in the “Measure” menu to open the parameter snapshot box.



In the parameter snapshot box, click on the “Source” to select the source to be tested, CH1-CH4 and Math1-Math4 can be selected.

The color of measured results is consistent with the color of all sources.

10.5. Parameter Measurement

Press the **Measure** key on the front panel, click on the “Parameter Measurement” in the “Measure” menu to open the parameter measurement. The parameter measurement info box will not be displayed if the parameter measurement is not ticked.



The parameter measurement is displayed above volts/div info box, showing the measure parameter and the current value. During the measurement, the counter, voltmeter is displayed on the far left by default, and the custom parameter follow behind. The parameter measurement supports the setting of up to 27 parameters.

The custom parameter measurement in the parameter measurement info box can be cancelled by clicking "-" in the top right corner.

10.6. Measurement Statistics

Press the **Measure** key on the front panel, tick on the "Measurement Statistics" in the "Measure" menu to open the measurement statistics. The statistic results of all parameter measurement are displayed in the "Parameter measurement" box at the bottom of screen

Statistics: current value, maximum, minimum, average value, standard deviation, count and statistical diagram.

Once the measurement statistics are enabled, a statistical diagram based on the average value can be generated. There are two types of statistical diagram: histogram and tendency chart.

Select the statistical diagram by clicking on the diagram switch below "Measure" items on the far left.



10.7. Add Parameter

Add the parameter to be tested to the parameter measurement info box, enter the “Add parameter” menu using the following steps.

- Press the **Measure** key on the front panel, click on the “Add parameter” in the “Measure” menu to enter the add parameter menu.
- Click on the icon **+** in the parameter measurement info box to enter the add parameter menu.

In the add parameter menu, switch different parameter menu by clicking on the “Vertical”, “Horizontal”, “Other” or slide the menu to left or right, and select this parameter to enter the related measurement. This oscilloscope supports up to 21 kinds of parameter measurements to be opened at the same time.

a. Source

Click on the “Source 1” or “Source 2” to select C1 - C4, M1 - M4, or D0-D15. When D0 - D15 is selected as the measurement source, only certain addible parameters are available. Supported parameters are highlighted, while unsupported parameters are grayed out.

b. Addible parameters

- Vertical parameter: Maximum, minimum, peak-to-peak, top, bottom, amplitude, middle value, average value, period average, RMS (root mean square), RMS of cycle, AC RMS, AC RMS of cycle, area, cycle area, positive area, negative area, positive cycle area, negative cycle area, positive overshoot, negative overshoot, positive preshoot, and negative

preshoot.



- Horizontal parameter: Period, frequency, rise time, fall time, positive pulse width, negative pulse width, positive duty ratio, negative duty ratio, positive pulse width number, negative pulse width number, rising edge, falling edge, rising edge number, falling edge number, burst width, burst interval, burst period, and burst period number.

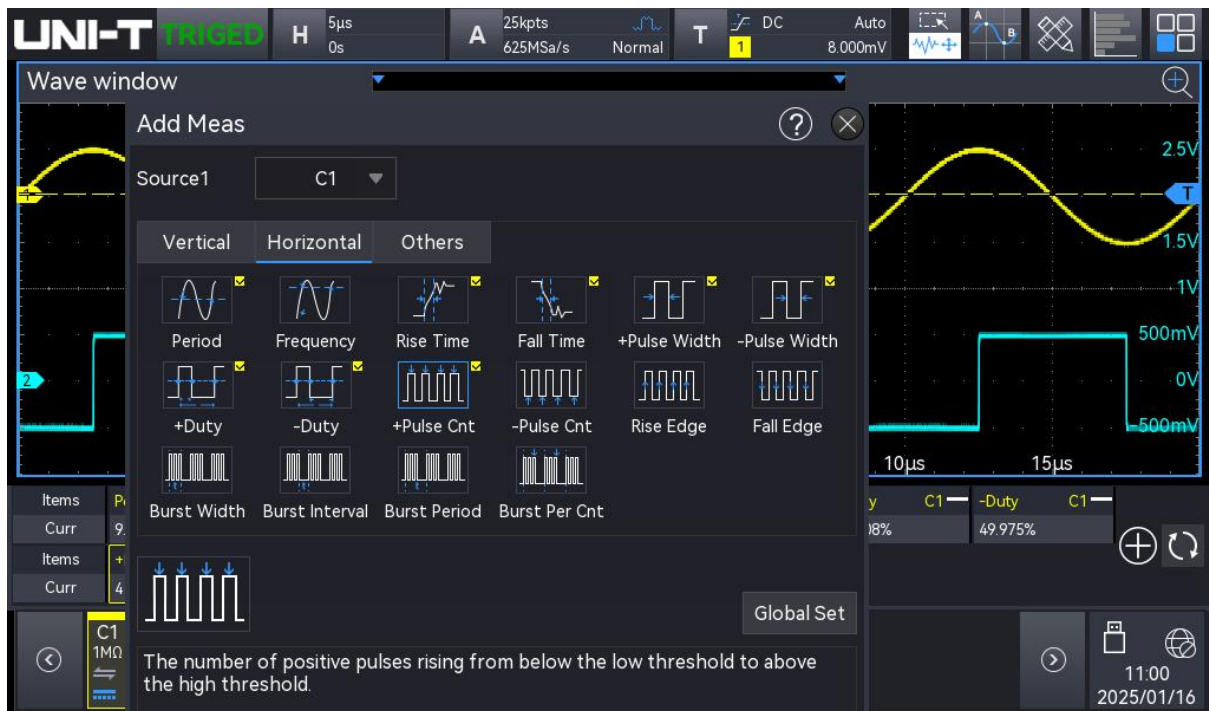

- Other parameters: Ratio, period ratio, setup time, hold time, setup and hold ratio, FRFR, FRFF, FFFR, FFFF, FRLF, FRLR, FFLR, FFLF, Delay(r-r), Delay(f-f), phase (r-r), and phase (f-f).



When the power analysis is set to power quality mode, the power quality-related parameters can be added to the Measure module. These parameters will be hidden if the power quality analysis is not activated.

- Power quality parameter: Voltage peak, voltage RMS, voltage peak factor, current peak, current RMS, current peak factor, active power, reactive power, apparent power, power factor, and power phase angle.



- Surge current parameter: Surge current



10.8. Clear Added Measurement

This oscilloscope allows the user to delete all added measurements.

- In the “Add measurement” menu, click on the added parameter to select and to delete.
- In the results window at the bottom of screen, click on the “-” in the top right corner of any measurement to delete the currently selected measurement.
- Press the **Measure** key on the front panel, click on the “Clear” in the “Measurement” menu to delete all added measurements.

10.9. Global Setting

Press the **Measure** key on the front panel, click on the “Global setting” in the “Measurement” menu to enter the “Advanced setting” menu.

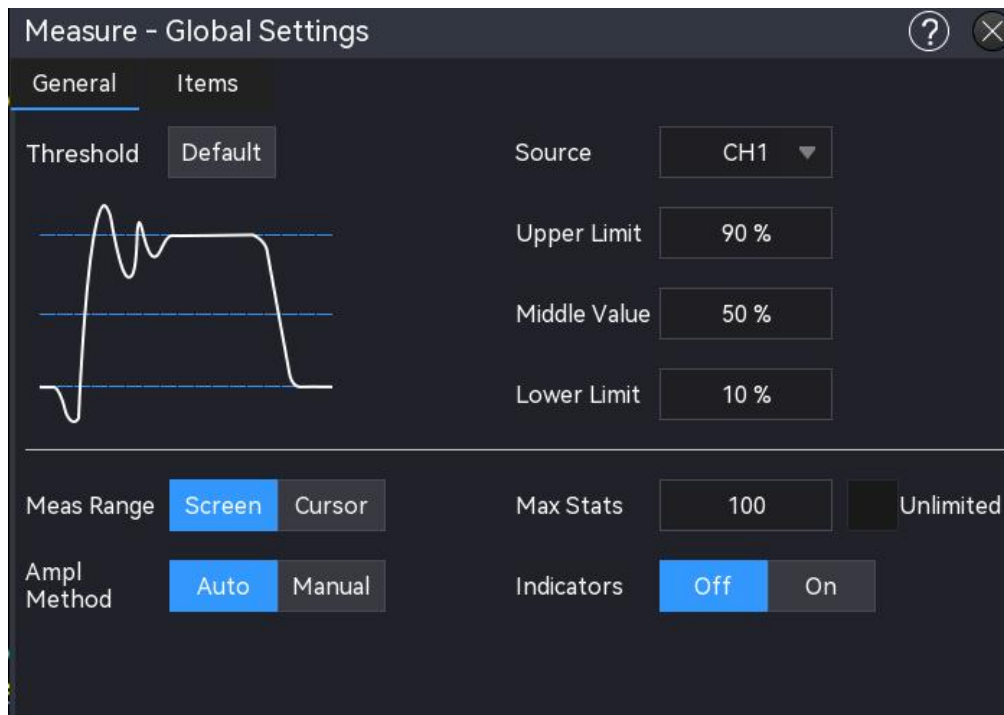

The general and measurement settings can be set in the “Advanced setting” menu.

(1) General Setting

a. Threshold

- Default: Click on the “Default” to restore the upper limit, middle value and lower limit to default value.
- Source: Click on the “Source” to select the channel to be measured, CH1-CH4, Math1-Math4 can be selected.
- Upper limit: Set the upper limit of reference level for waveform measurement. Click on the “High” input field to open the numeric keypad to set the upper limit. Alternatively, rotate the Multipurpose A rotary knob adjust the upper limit. The default percentage is 90%, and the range can be set from 7% to 95%.
- Middle value: Set the middle value of reference level for waveform measurement. Click on the “Middle” input field to open the numeric keypad to set the middle value. Alternatively, rotate the Multipurpose A rotary knob to adjust the middle value. The default percentage is 50%, and the range can be set from 6% to 94%.
- Lower limit: set the lower limit of reference level for waveform measurement. Click on the “Low” input field to open the numeric keypad to set the lower limit. Alternatively, rotate the Multipurpose A rotary knob adjust the lower limit. The default percentage is 10%, and the range can be set from 5% to 93%.

b. Measurement Range

The measurement window in the horizontal direction will affect the results of all

parameter measurement. The measure range can be set to the screen area or cursor area.

- Screen area: Full screen
- Cursor area: The horizontal time cursor area allows the user to set the cursor position as required and to measure the results directly within the cursor area.

c. Maximum Count

It is a custom parameter. If the measurement statistics are switched on, the number of statistics can be set from 10 to 10000, or check unlimited times.

d. Amplitude Calculation Strategy

The amplitude measure mode can be set to auto or manual. The strategy affects the measure strategy of top and bottom value.

- Auto: According to the input signal, the amplitude calculation strategy is automatically selected.
- Manual: Based on the manually selected top and bottom strategy, the corresponding amplitude values are calculated.

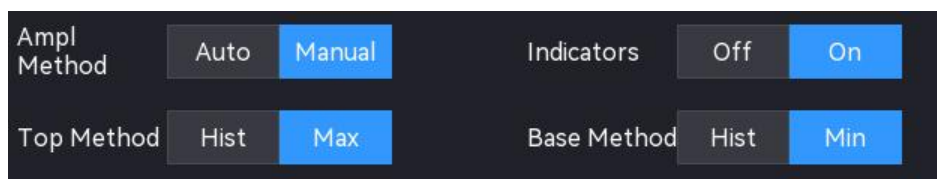

e. Top Calculation Strategy

- Histogram: counting the value that greater than the peak-to-peak 1/2, the highest probability is recognized as the top value.
- Maximum: the maximum of waveform is recognized as the top value.

f. Bottom

- Histogram: counting the value that less than the peak-to-peak 1/2, the highest probability is recognized as the bottom value.
- Minimum: the minimum of waveform is recognized as the bottom value.

g. Indicator

Click on the "Indicator" to switch on/off the indicator.

When the cursor indicator is switched on, one or more cursors appear on the screen. Before opening the cursor indicator, at least one automatic measurement parameter should be opened, and the number of cursors will change according to the measurement parameter.

(2) Measurement Setting

a. RMS

- Unit: Set the unit display for root-mean-square (RMS)-related parameters. The available options are RMS, dBm, and dB. When the unit is switched to dBm, ensure that the test load impedance is 50 Ω to maintain measurement accuracy.



- Reference value: When the unit is set to dB, the reference amplitude can be configured. The reference range can be set from 0.001 to 1000.
- b. Burst
 - Idle time: Set the idle time for the measurement of burst width, burst interval, burst period, and burst period number.
 - Idle level: High or low level.
- c. Setup & Hold Setting
 - Clock edge: Rising edge, falling edge, or arbitrary edge.
 - Data edge: Rising edge, falling edge, or arbitrary edge.

11. Power Analysis

- [Power Quality](#)
- [Harmonics Analysis](#)
- [Surge Current](#)
- [Rds \(on\)](#)
- [Switching Loss](#)
- [Slew Rate](#)
- [Safe Operating Area](#)
- [Modulation Analysis](#)

This oscilloscope supports power analysis function (option), it can help the user to quickly analyze the efficiency and reliability of switch power. With this function, the user can analyze the power quality, harmonics analysis, and surge current of the input power

The power analysis menu can be entered using the following steps.

- Click the **Analyze** key on the front panel, click on the “Power Analysis” in the “Analyzer” menu to enter the “Power Analysis” menu.
- Click the Home icon  in the top right corner and select the power analysis icon  to enter the “Power Analysis” menu.
- If the power analysis is added to the toolbar, click the power analysis icon  in the toolbar in the top right corner to enter the “Power Analysis” menu.

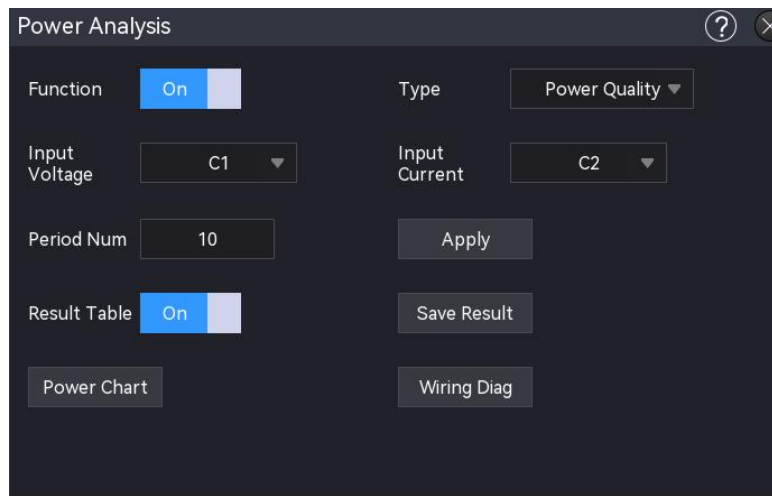

11.1. Power Quality

The power quality can measure the quality of AC input wire. The measuring parameter of power quality analysis includes the voltage peak, RMS voltage, voltage peak factor, current peak, RMS current, current peak factor, active power, reactive power, apparent power, power factor, and power phase angle.

(1) Analysis Mode

Click on the “Analysis Mode” to select “Power Quality”.

(2) Function Switch

Click on the “Function Switch” to switch the power analysis ON/OFF.

(3) Wiring Diagram

Click on the “Wiring Diagram” to display the wiring diagram of the power quality analysis, please follow the instructions to make the wiring connection, as shown in the following figure.

- Connect the voltage probe D+ to AC input live wire.
- Connect the voltage probe D- to AC input zero wire.
- Select the appropriate attenuation rate on the voltage probe.
- Connect the current probe to AC input live wire, the arrow indicates the direction of the current flow.
- Connect the voltage and current probe to the oscilloscope's channel.

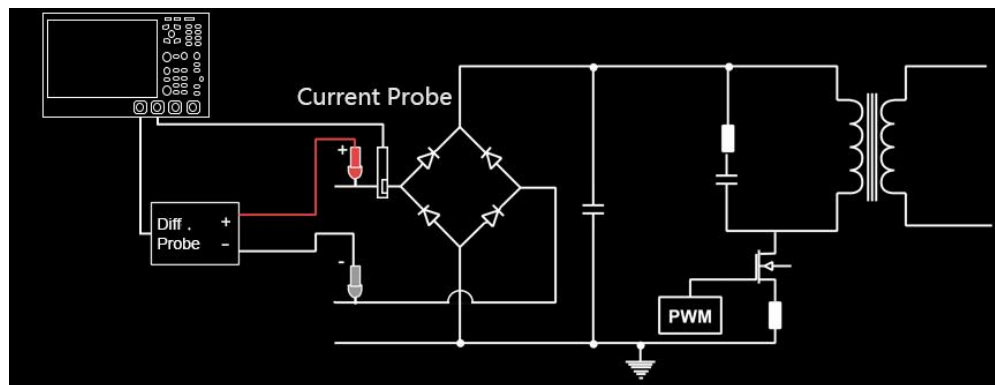

(4) Input Voltage

Click on the “Input Voltage” to select the channel to collect voltage (C1-C4), the voltage channel should set the unit and probe multiplying ratio according to the input voltage probe.

(5) Input Current

Click on the “Input Current” to select the channel to collect voltage (C1-C4), the current channel should set the unit and probe multiplier according to the input current probe.

(6) Cycle Number

Double click on the “Cycle Number” input field to open the numeric keypad to set the cycle number. For details on the use of the numeric keypad, refer to the section of [5.8 Parameter](#)

Setting. Alternatively, select the parameter, use the Multipurpose A rotary knob to adjust the cycle number. The setting range can be set from 1 to 40.

(7) Application

Click on the “Application” key, the oscilloscope will be automatically set by the user-defined input voltage, input current and cycle number (Note: multiply operation in Math function will also be automatically enabled) and perform the power quality analysis.

The measurement results are displayed in two forms, graph and result table.

- Graph result: Voltage waveforms, current waveforms, and power waveforms (power diagrams) are product of the current waveform and voltage waveform.
- Result table: The statistic results are displayed in a table.

(8) Power Diagram

Click on the “Power Diagram” key, the oscilloscope will open the multiply operation of Math1 by default and display the power waveforms.

(9) Result Table

Click on the “Result Table” key to open the measurement results table of power quality analysis.



(10) Power Quality Measurement Results

Voltage peak	Measure the voltage parameters at the input of the power supply, such as voltage peak, RMS voltage, and voltage crest factor.
RMS voltage	Effective voltage value $V_{rms} = \frac{1}{N} * \sqrt{\sum_{i=0}^{n-1} V_i^2}$
Voltage peak factor	$V_{Crest} = V_{peak} / V_{rms}$

Current peak	Measure the current parameters at the input of the power supply, such as current peak, RMS current, and current crest factor.
RMS current	Root mean square of current $I_{rms} = \frac{1}{n} * \sqrt{\sum_{i=0}^{n-1} I_i^2}$
Current peak factor	$I_{Crest} = I_{peak} / I_{rms}$
Active power	A portion of the power flux calculated by averaging over the entire period of the AC waveform that results in a net transfer of energy in one direction.
Reactive power	Difference between apparent power and effective power caused by reactance.
Apparent power	Due to the partial power flux generated by the stored energy, it is returned to the source in each cycle.
Power factor	The ratio of the actual power and the apparent power.
Power phase angle	In power triangle (apparent power $^2 =$ active power $^2 +$ reactive power 2), the phase angle is the angle between the apparent power and active power, it indicates the amount of reactive power.

(11) Save Results Table

After opening the result table, click the "Save event table" to pop up the export setting menu, the data can be saved in *.csv and *.pdf to internal storage or external USB disk drive (when a USB is detected). For the setting steps, refer to the section of [Save and Load](#).

11.2. Harmonics Analysis

Switching power supplies introduce several harmonics from the AC mains supply. Because these harmonics can be fed back into the supply circuit and cause problems for other equipment on the circuit, standard limits have been set for these harmonics. Standard limits are set for these harmonics because they can be transmitted back to the power circuit and cause problems with other equipment on the circuit.

Switching power supplies can be tested for harmonic analysis by IEC61000-3-2 pre-compliance standard (Class A, B, C or D). The analysis shows up to 40 harmonics.

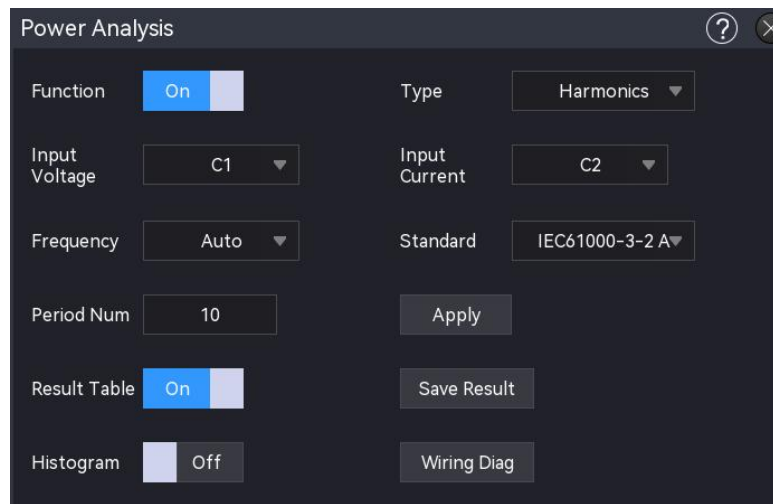

(1) Analysis Mode

Click on the “Analysis Mode” to select “Harmonic Analysis”.

(2) Function Switch

Click on the “Function Switch” to switch the power analysis ON/OFF.

(3) Wiring Diagram

Click on the “Wiring Diagram” to display the wiring diagram of the current harmonics analysis, please follow the instructions to make the wiring connection, as shown in the following figure.

- Connect the voltage probe D+ to AC input live wire.
- Connect the voltage probe D- to AC input zero wire.
- Select the appropriate attenuation rate on the voltage probe.
- Connect the current probe to AC input live wire, the arrow indicates the direction of the current flow.
- Connect the voltage and current probe to the oscilloscope's channel.

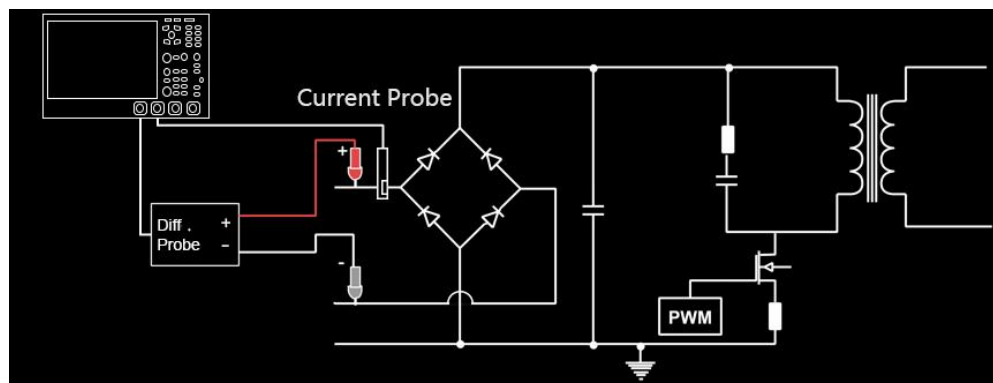

(4) Input Voltage

Click on the “Input Voltage” to select the channel to collect voltage (C1-C4), the voltage channel should set the unit and probe multiplying ratio according to the input voltage probe.

(5) Input Current

Click on the “Input Current” to select the channel to collect voltage (C1-C4), the current channel should set the unit and probe multiplying ratio according to the input current probe.

(6) Line Frequency

Click on the “Line Frequency” to set the input line frequency, it can be set to auto acquire, 50 Hz, 60 Hz, or 400 Hz.

(7) Harmonic Standard

Click on the “Harmonic Standard” to select the test standard for harmonic analysis (IEC61000-3-2 A/B/C/D) .

- IEC61000-3-2 A: It is suitable for balanced three-phase equipment, household appliances (except D-type), tools (except portable tools), incandescent lamp, and audio frequency apparatus.
- IEC61000-3-2 B: It is suitable for portable tools.
- IEC61000-3-2 C: It is suitable for lighting equipment. Press the Application softkey (in “Power Application” main menu), C-type should perform the power factor.
- IEC61000-3-2 D: It is suitable for the device that the rated power is less than or equal to 600W, the type is personal PC, personal computer monitors, and television receiver.

(8) Cycle Number

Double click on the “Cycle Number” input field to open the numeric keypad to set the cycle number. For details on the use of the numeric keypad, refer to the section of [5.8 Parameter Setting](#). Alternatively, select the parameter, use the [Multipurpose A](#) rotary knob to adjust the cycle number. The setting range can be set from 1 to 40.

(9) Application

Click on the “Application” key, the oscilloscope will be automatically set by the user-defined input voltage, input current and cycle number (Note: FFT1 automatically switched on to calculate current harmonics) and perform the harmonics analysis.

The measurement results are displayed in three forms, graph, result table and histogram.

- Graph result: Voltage waveforms, current waveforms, and harmonic analysis waveforms (FFT).
- Result table: The statistic results are displayed in a table.
- Histogram: The current harmonic results are displayed in histogram.

(10) Histogram

Click on the “Histogram” key to open the histogram of harmonic analysis.



(11) Result Table

Click on the “Result Table” key to open the measurement results table of power quality analysis.

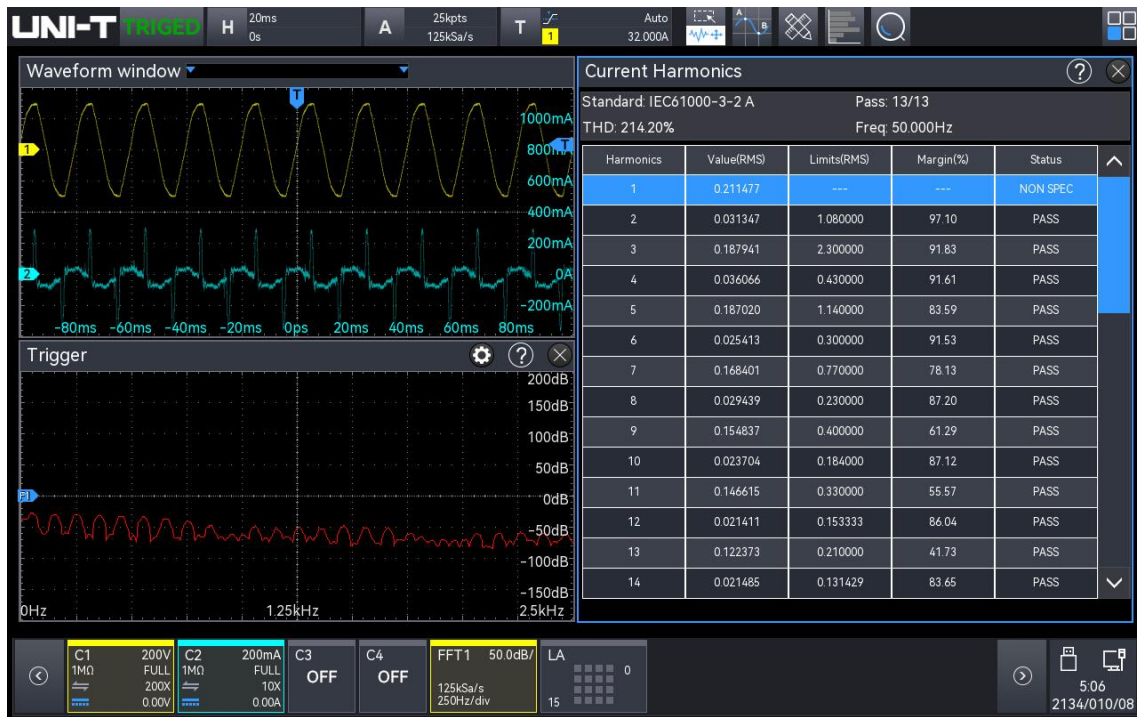

(12) Harmonic Analysis Measurement Results

FFT waveforms	Displays the frequency component in the input current. Using Hanning window to perform FFT.
Harmonic, actual value	The following values are displayed for the first 40 harmonics. Actual value (RMS): The measured values are displayed with the

(RMS), limit (RMS), margin, and state	<p>unit that is specified by the Harmonic unit.</p> <p>Limit (RMS): Limit set by the selected harmonic analysis standard</p> <p>Margin: Margin set by the selected harmonic analysis standard.</p> <p>Pass/Fail: Whether the value passes or fails according to the selected harmonic analysis standard.</p> <p>Rows in a table or bars in a bar graph are colored according to the pass/fail value. The critical result is greater than 85% of the limit but less than 100% of the limit.</p>
THD (Total Harmonic Distortion)	$TDH = 100 \times \frac{\sqrt{X_2^2 + X_3^2 + X_n^2 + \dots}}{X_1}$ <p>X_n = voltage or current of each harmonic</p> <p>X_1 = basic voltage or current</p>

(13) Save Results Table

After opening the result table, click the "Save event table" to pop up the export setting menu, the data can be saved in *.csv and *.pdf to internal storage or external USB disk drive (when a USB is detected). For the setting steps, refer to the section of [Save and Load](#).

11.3. Surge Current

Once the load is switched on, there is usually a large current, which is called the surge current. For capacitive loads, this phenomenon is equivalent to a short circuit when the capacitor is switched on, and the instantaneous current is theoretically infinite.

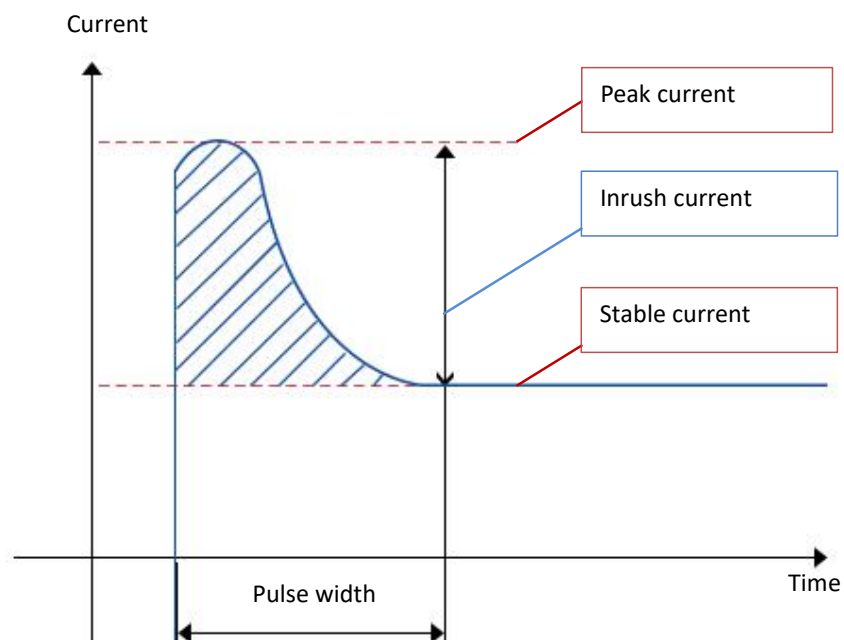

(1) Analysis Mode

Click on the “Analysis Mode” to select “Surge Current”.

(2) Function Switch

Click on the “Function Switch” to switch the power quality ON/OFF.

(3) Wiring Diagram

Click on the “Wiring Diagram” to display the wiring diagram of the power quality analysis, please follow the instructions to make the wiring connection, as shown in the following figure.

- Connect the voltage probe D+ to AC input live wire.
- Connect the voltage probe D- to AC input zero wire.
- Select the appropriate attenuation rate on the voltage probe.
- Connect the current probe to AC input live wire, the arrow indicates the direction of the current flow.
- Connect the voltage and current probe to the oscilloscope's channel.

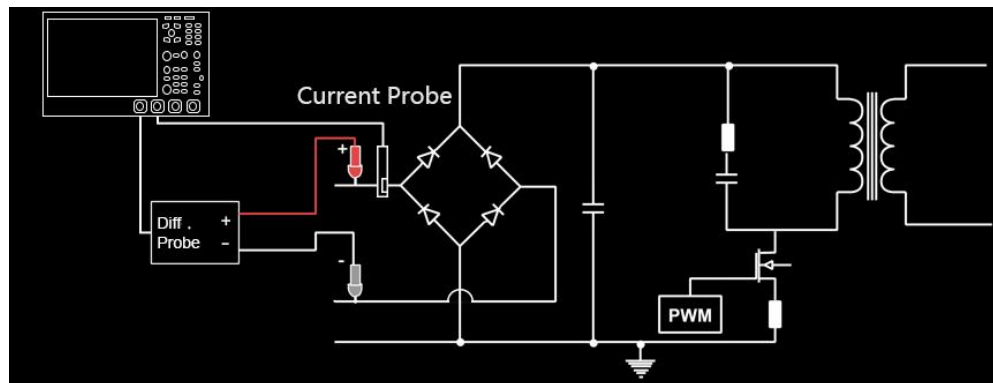

(4) Input Voltage

Click on the “Input Voltage” to select the channel to collect voltage (CH1-CH4) , the voltage channel should set the unit and probe multiplying ratio according to the input voltage probe.

(5) Input Current

Click on the “Input Current” to select the channel to collect voltage (CH1-CH4) , the current channel should set the unit and probe multiplying ratio according to the input current probe.

(6) Maximum Input Voltage (RMS)

Assign the maximum input voltage and set the vertical calibration of channel voltage.

Double click on the “Maximum Input Voltage (RMS)” input field to open the numeric keypad to set the maximum input voltage.

For details on the use of the numeric keypad, refer to the section of [5.8 Parameter Setting](#).

Alternatively, select the parameter, use the Multipurpose A rotary knob to adjust the maximum input voltage. The setting range can be set from 1 V to 1000 V.

(7) Prospective Current

The prospective current is used to assign the expected inrush current amplitude and set the vertical calibration of channel current.

For details on the use of the numeric keypad, refer to the section of [5.8 Parameter Setting](#).

Alternatively, select the parameter, use the Multipurpose A rotary knob to adjust the prospective current. The setting range can be set from 100 mA to 500 A.

(8) Application

Click on the “Application” key and follow the instructions on the screen. The result will be displayed after the analysis is complete.

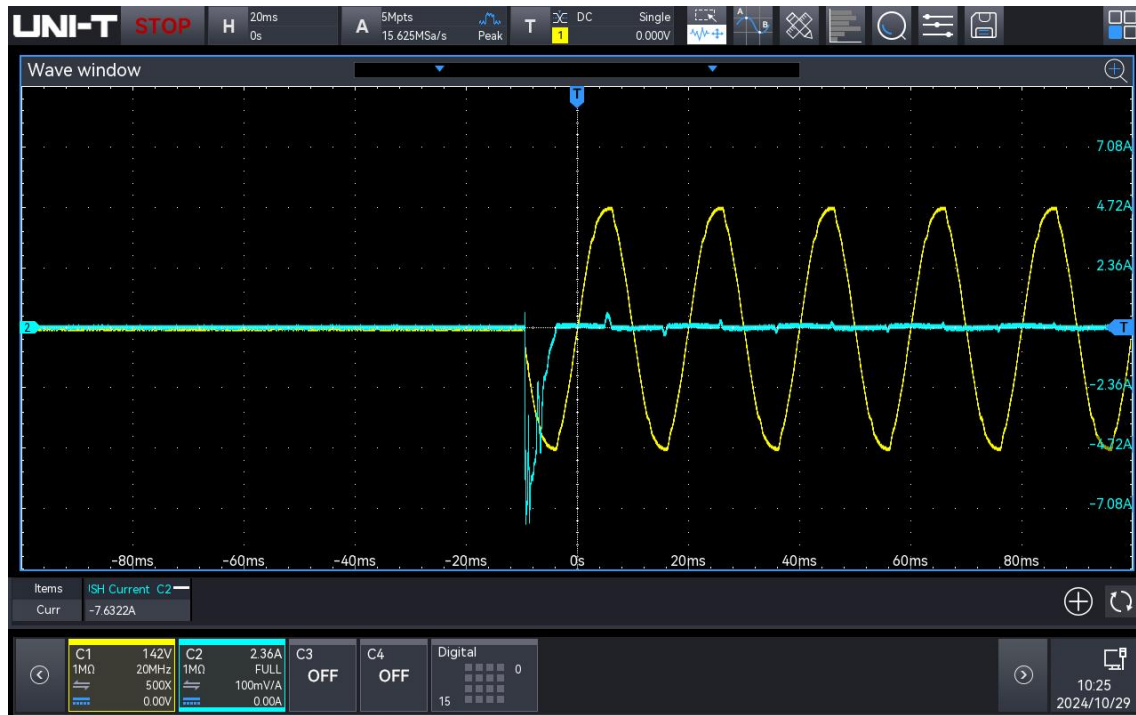

11.4. Rds (on)

This measurement characterizes the on-state resistance, $R_{ds(on)}$, between the drain and source of the switching device during the conduction phase of the switching cycle.

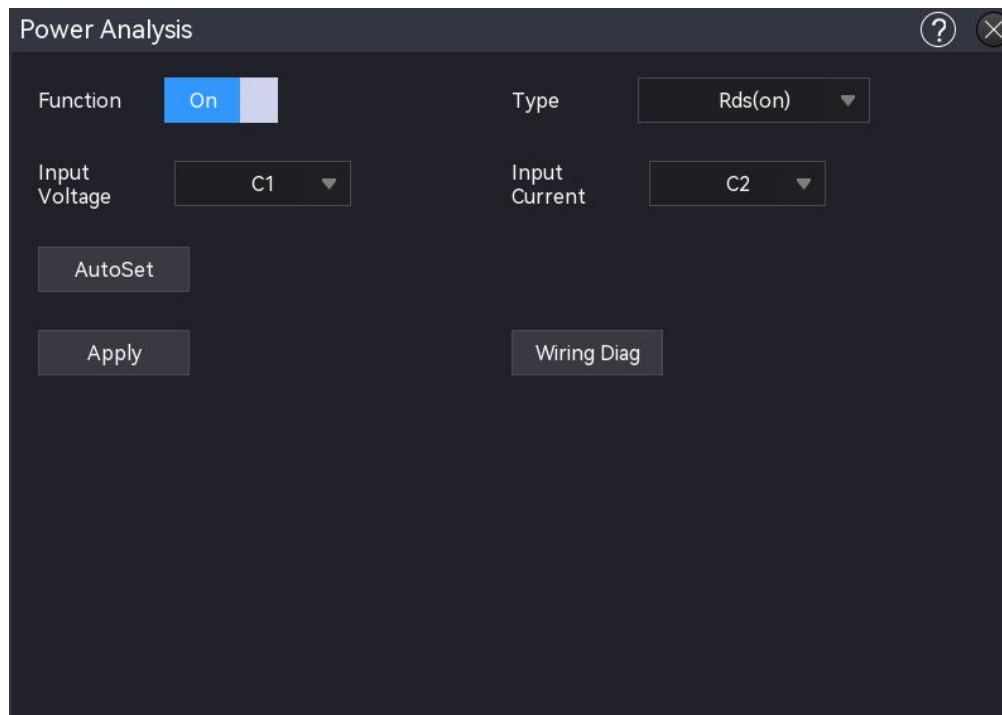

(1) Analysis Type

Click on the "Type" to select "Rds(on)".

(2) Function Switch

Click on the "Function" to toggle the power analysis ON/OFF.

(3) Wiring Diagram

Click on the "Wiring Diag" to display the wiring diagram of Rds (on). Follow the instructions to make the wiring connections as shown in the figure below. Tap the icon in the top-right corner to close the wiring diagram.

a. Voltage Probe

- Connect D+ to the drain of the MOSFET.
- Connect D- to the source of the MOSFET.
- Select an appropriate probe attenuation ratio.

b. Current Probe

- Connect current probe to the source of the MOSFET. The arrow on the probe indicates the direction of the current.
- Configure "Input Voltage" and "Input Current" to assign the corresponding channels for the probe mentioned above.

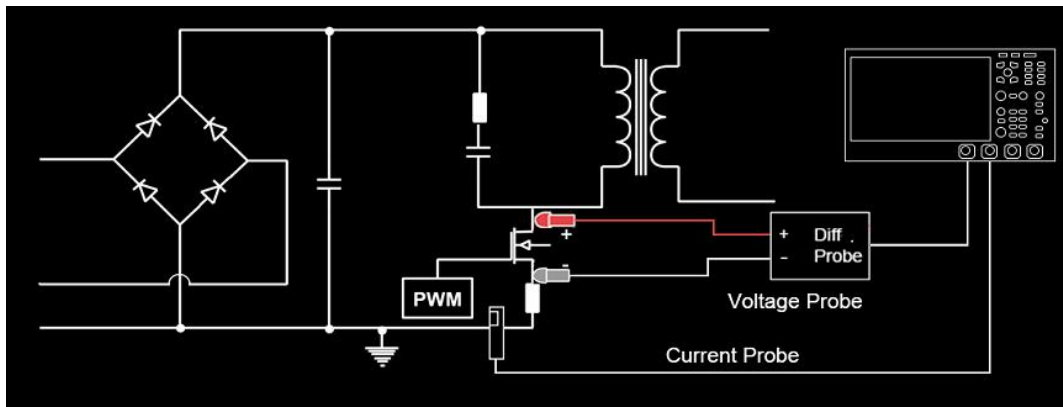

(4) Input Voltage

Click on the "Input Voltage" to select the channel to collect voltage (C1 - C4), the voltage channel should set the unit and probe attenuation ratio according to the input voltage probe.

(5) Input Current

Click on the "Input Current" to select the channel to collect current (C1 - C4), the current channel should set the unit and probe attenuation ratio according to the input current probe.

(6) Auto Setting

After configuring the input voltage and input current sources, the "AutoSet" function will automatically open the voltage and current channels, set the channel units to V and A, and close the other channels.

(7) Apply

Click the "Apply" to perform the power analysis function, automatically add the $R_{ds(on)}$ parameters while enabling the statistics.



(8) Slew Rate Measurement Results

Rds(on)	The effective resistance of the power switch component during the conduction stage.
---------	---

11.5. Switching Loss

On-state losses occur when physical and parasitic capacitors are charged. During this process, the inductor generates a magnetic field, causing transient resistance losses. Similarly, when a switched-mode power supply is turned off, energy is discharged and interacts with various components, even if the mains power is unplugged, resulting in additional losses.

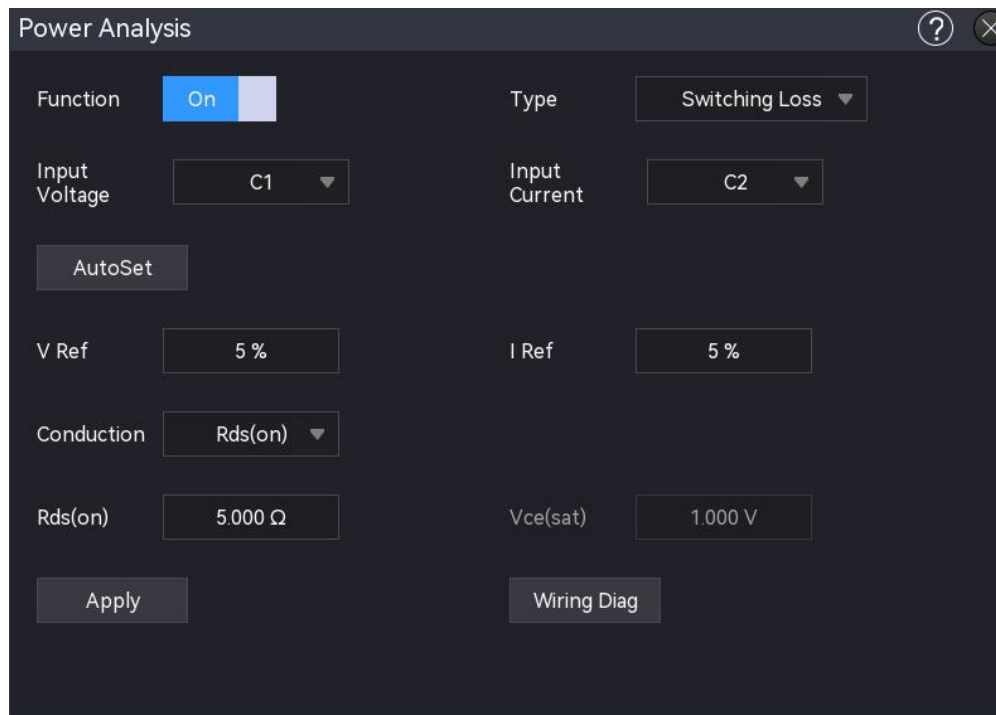

(1) Analysis Type

Click on the “Type” to select “Switching Loss”.

(2) Function Switch

Click on the “Function” to toggle the power analysis ON/OFF.

(3) Wiring Diagram

Click on the “Wiring Diag” to display the wiring diagram of switching loss. Follow the instructions to make the wiring connections as shown in the figure below. Tap the icon in the top-right corner to close the wiring diagram.

c. Voltage Probe

- Connect D+ to the drain of the MOSFET.
- Connect D- to the source of the MOSFET.
- Select an appropriate probe attenuation ratio.

d. Current Probe

- Connect current probe to the source of the MOSFET. The arrow on the probe indicates the direction of the current.
- Configure "Input Voltage" and "Input Current" to assign the corresponding channels for the probe mentioned above.

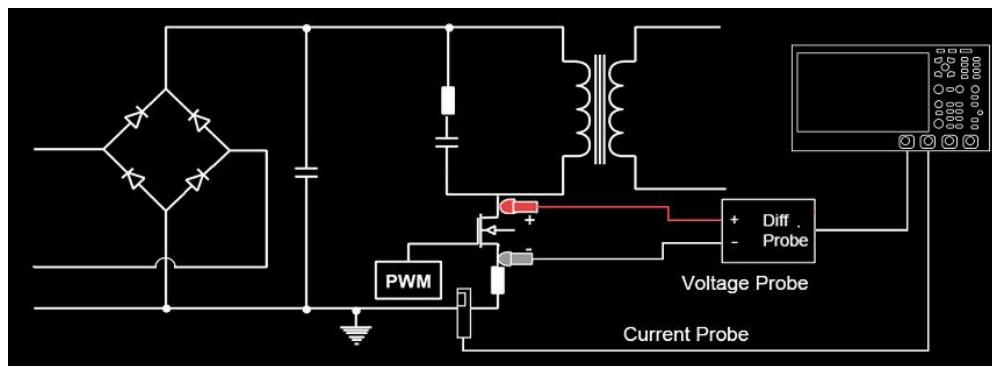

(4) Input Voltage

Click on the "Input Voltage" to select the channel to collect voltage (C1 - C4), the voltage channel should set the unit and probe attenuation ratio according to the input voltage probe.

(5) Input Current

Click on the "Input Current" to select the channel to collect current (C1 - C4), the current channel should set the unit and probe attenuation ratio according to the input current probe.

(6) Auto Setting

After configuring the input voltage and input current sources, the "AutoSet" function will automatically open the voltage and current channels, set the channel units to V and A, and close the other channels.

(7) Voltage Reference

The voltage reference is used to identify the conducting state. When the voltage falls below the voltage reference percentage of the maximum waveform voltage, it is recognized as the on-state. Select the parameter field and use the Multipurpose A rotary knob to adjust the reference value, which ranges from 1% to 100%.

(8) Current Reference

The current reference is used to identify the conducting state. When the current falls below the current reference percentage of the maximum waveform current, it is recognized as the off-state. Select the parameter field and use the Multipurpose A rotary knob to adjust the reference value, which ranges from 0% to 100%.

(9) Conduction Type

Click on the "Conduction" to select the conduction types: voltage waveform, Rds(on), or Vce(sat).

- Voltage waveform: The power waveform uses the original data. The calculation formula is $P = V * I$, $E = P * T$.
- Rds(on): For on-state areas, where the voltage or current is lower than the voltage reference (adjustable), the power calculation formula is $P = I^2 * R_{ds(on)}$.

For off-state areas, where the voltage or current is lower than the current reference

(adjustable), the power calculation formula is $P = 0$ watt.

- Vce(sat): For on-state areas, where the voltage or current is lower than the voltage reference (adjustable), the power calculation formula is $P = Vce(sat) * I$.

For off-state areas, where the voltage or current is lower than the current reference (adjustable), the power calculation formula is $P = 0$ watt.

(10) Rds(on)

The on-resistance can be configured when the conduction type is set to Rds(on), with a range from 1 mΩ to 200 Ω.

(11) Vce(sat)

The Vce voltage can be configured when the conduction type is set to Vce(sat), with a range from 50 mV to 2.5 V.

(12) Apply

Click on the "Apply" to enable the oscilloscope to automatically open the Math1 channel based on the user-defined input voltage, input current, voltage reference, and current reference. It will set the basic operation to "voltage source × current source" and automatically add all switching loss parameters while enabling the statistics.



(13) Switching Loss Measurement Results

Switching period number	Meets the required number of switching periods.
Switching-on power loss	The power loss of power switch device during the switching-on process, measured in watts (W).
Conduction power loss	The power loss of power switch device during the conducting process, measured in watts (W).
Switching-off power loss	The power loss of power switch device during the switching-off process, measured in watts (W).
Total power loss	The total power loss of power switch device during the whole switching period, measured in watts (W).
Switching-on energy loss	The energy loss of power switch device during the switching-on process, measured in joules (J).
Conduction energy loss	The energy loss of power switch device during the conducting process, measured in joules (J).
Switching-off energy loss	The energy loss of power switch device during the switching-off process, measured in joules (J).
Total energy loss	The total energy loss of power switch device during the whole switching period, measured in joules (J).

11.6. Slew Rate

Slew rate analysis measures the rate of voltage or current variation during the switching period.

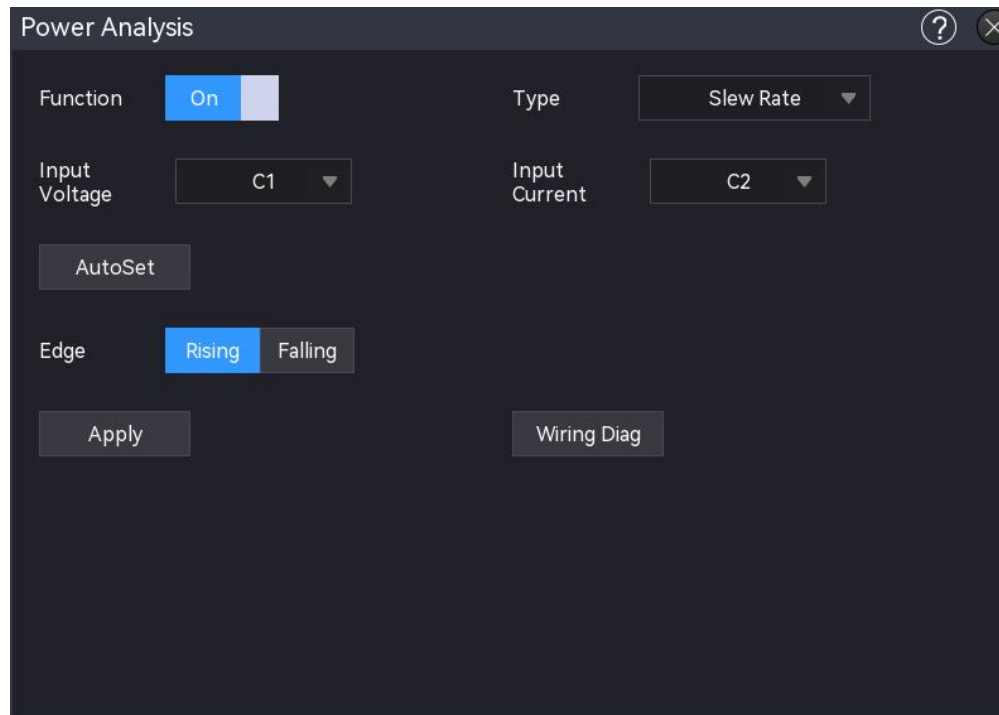

- (1) Analysis Type
Click on the “Type” to select “Slew Rate”.
- (2) Function Switch
Click on the “Function” to toggle the power analysis ON/OFF.
- (3) Wiring Diagram
Click on the “Wiring Diag” to display the wiring diagram of slew rate. Follow the instructions to make the wiring connections as shown in the figure below. Tap the icon in the top-right corner to close the wiring diagram.
 - a. Voltage Probe
 - Connect D+ to the drain of the MOSFET.
 - Connect D- to the source of the MOSFET.
 - Select an appropriate probe attenuation ratio.
 - b. Current Probe
 - Connect current probe to the source of the MOSFET. The arrow on the probe indicates the direction of the current.
 - Configure "Input Voltage" and "Input Current" to assign the corresponding channels for the probe mentioned above.

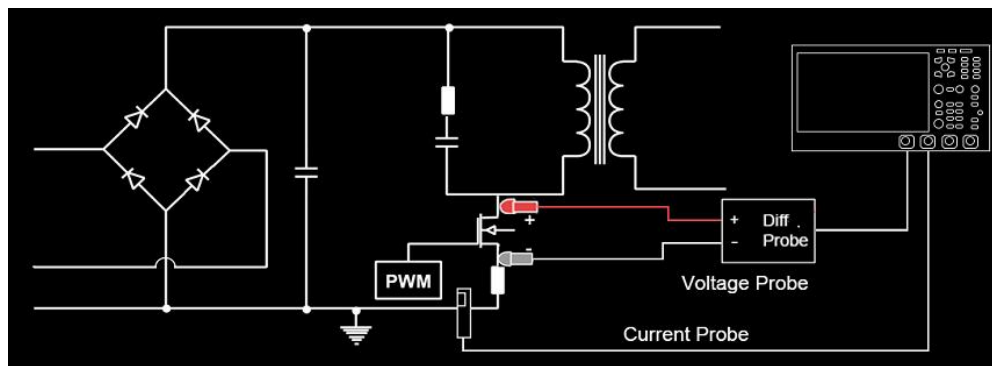

- (4) Input Voltage

Click on the "Input Voltage" to select the channel to collect voltage (C1 - C4), the voltage channel should set the unit and probe attenuation ratio according to the input voltage probe.
- (5) Input Current

Click on the "Input Current" to select the channel to collect current (C1 - C4), the current channel should set the unit and probe attenuation ratio according to the input current probe.
- (6) Auto Setting

After configuring the input voltage and input current sources, the "AutoSet" function will automatically open the voltage and current channels, set the channel units to V and A, and close the other channels.
- (7) Edge

Select the signal edge to be tested: rising edge or falling edge.
- (8) Apply

Click on the "Apply" to enable the oscilloscope to automatically open the Math1 channel based on the user-defined input voltage, input current, and edge. It will perform the current power analysis function and automatically add all slew rate parameters while enabling the statistics.



(9) Slew Rate Measurement Results

dv/dt	The rate of change of voltage over time is analyzed during the switching process of a power switching device.
di/dt	The rate of change of current over time is analyzed during the switching process of a power switching device.

11.7. Safe Operating Area

The safe operating area (SOA) of a MOSFET defines the limiting conditions for voltage, current, and power consumption. Under these conditions, the MOSFET can operate without sustaining self-damage.

The oscilloscope can automatically generate the SOA based on parameters such as voltage limits, current limits, and power limits set in the configuration menu. It evaluates whether the voltage and current of the switching device during normal operation exceed this area. This feature helps designers quickly identify problems or potential risks in the circuit.

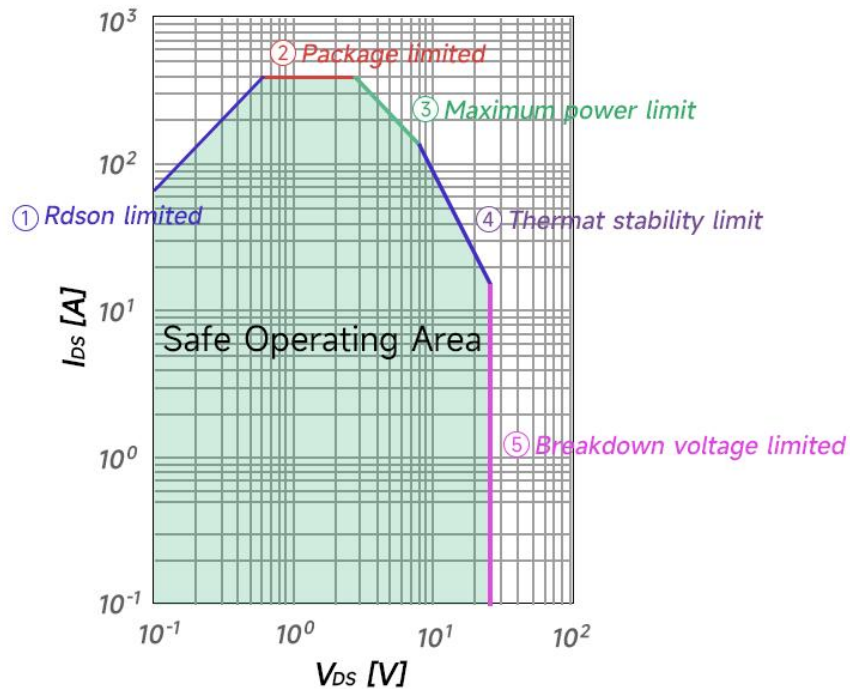

(1) Analysis Type

Click on the “Type” to select “SOA”.

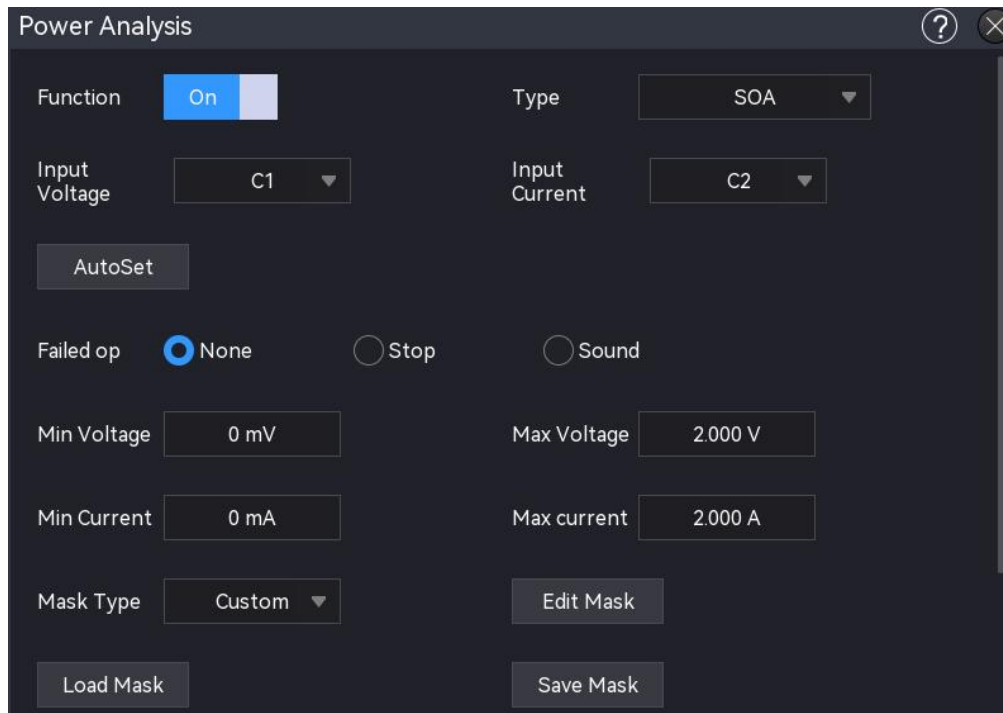

(2) Function Switch

Click on the “Function” to toggle the power analysis ON/OFF.

(3) Wiring Diagram

Click on the “Wiring Diag” to display the wiring diagram of safe operating area. Follow the instructions to make the wiring connections as shown in the figure below. Tap the icon in the

top-right corner to close the wiring diagram.

a. Voltage Probe

- Connect D+ to the drain of the MOSFET.
- Connect D- to the source of the MOSFET.
- Select an appropriate probe attenuation ratio.

b. Current Probe

- Connect current probe to the source of the MOSFET. The arrow on the probe indicates the direction of the current.
- Configure "Input Voltage" and "Input Current" to assign the corresponding channels for the probe mentioned above.

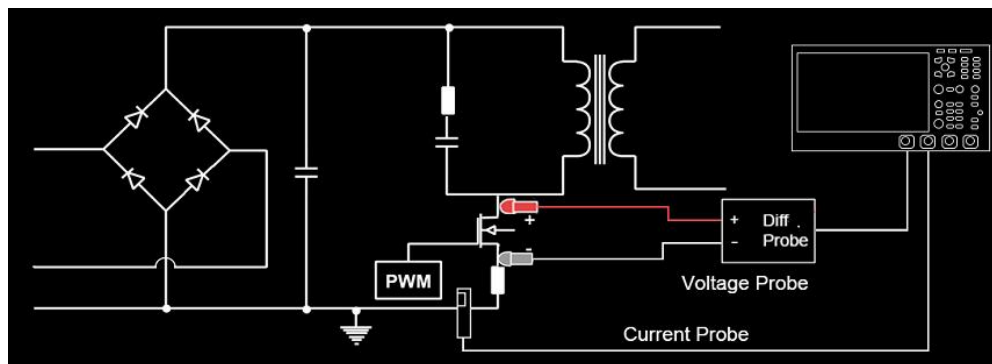

(4) Input Voltage

Click on the "Input Voltage" to select the channel to collect voltage (C1 - C4), the voltage channel should set the unit and probe attenuation ratio according to the input voltage probe.

(5) Input Current

Click on the "Input Current" to select the channel to collect current (C1 - C4), the current channel should set the unit and probe attenuation ratio according to the input current probe.

(6) Auto Setting

After configuring the input voltage and input current sources, the "AutoSet" function will automatically open the voltage and current channels, set the channel units to V and A, and close the other channels.

(7) Failure Operation

When the template performs a failure operation, it can be configured to perform no operation, stop operation, and sound alarm.

- No operation: If the template test fails, no operation will be performed, and the template test will continue.
- Stop operation: If the template test fails, the template test will stop immediately.
- Sound alarm: If the template test fails, the beeper will sound, but the template test will continue.

(8) SOA Gate Setting

Set the minimum and maximum values for SOA voltage and current axes, which configures the minimum voltage, maximum voltage, minimum current, and maximum current.

- Minimum voltage: Sets the display minimum value for SOA voltage axis, with a default value of 0 mV.
- Maximum voltage: Sets the display maximum value for SOA voltage axis, with a default value of 10 V.
- Minimum current: Sets the display minimum current for SOA voltage axis, with a default value of 0 mA.
- Maximum current: Sets the display maximum current for SOA voltage axis, with a default value of 10 A.

(9) Template Type

Set the generation type for SOA template, which configures the limit value and user-defined value. When the limit value is selected, the voltage limit, current limit, and power limit can be set. When the user-defined is selected, the operations of editing the template, importing the template, and saving the template can be performed.

- a. Limit value: Generates a template by configuring the voltage limit, current limit, and power limit.
 - Voltage limit: Sets the maximum VDS (Drain-Source Voltage), with a default value of 5 V.
 - Current limit: Sets the maximum IDM (Drain Current-Pulse), with a default value of 5 A.
 - Power limit: Sets the power limit of thermal resistance, with a default value of 25 W.
- b. User-defined: Generates a template by configuring user-defined operations, such as editing the template, importing the template, and saving the template.

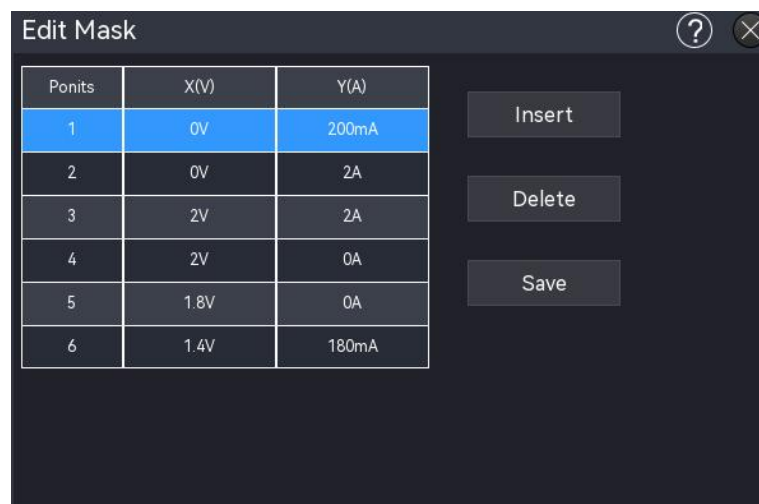

- **Edit template:** Click on the "Edit Template" to open the template box. The default template contains 6 points. The user can edit the template by inserting points, deleting points, or editing points, and then save the template.
 - Insert point: Insert a point below the selected point.
 - Delete point: Delete the selected point.
 - Edit point: Double-click the selected point to set its axis by configuring the voltage value and current value.
 - Save: Save the user-defined template and refresh the template in SOA waveform.

Note: The template point requires a block area; otherwise, the template cannot be saved.

- **Import template:** When the SOA template type is set to user-defined, the user can load and retrieve template files stored in the instrument's internal memory or an external USB flash drive (only when the USB flash drive is detected) and apply them to the current SOA test. Click "Import Template" to enter the file loading interface. Select the specified template file (*.csv) from the "Loading Path" and apply it to the current SOA test function.
- **Save template:** After editing the user-defined template, the user can save it in the *.csv format to the instrument's internal memory or an external USB flash drive (only when the USB flash drive is detected). Click "Save Template" to enter the file saving interface. Enter the corresponding information in the "File Name" and "Save Path" fields to save the template file to internal or external memory. For detailed saving instructions, please refer to the [Save and Load](#) section.

(10) SOA Waveform

Click on the "SOA Waveform" to toggle the waveform display state ON/OFF.

(11) Reset

Click on the "Reset" to clear the template test results and restart the template test.

(12) Apply

Click on the "Apply" to enable the oscilloscope to perform the power analysis function based on the user-defined input voltage, input current, failure operation, minimum voltage, maximum voltage, minimum current, maximum current, and template limit. It will automatically open the SOA waveform display.

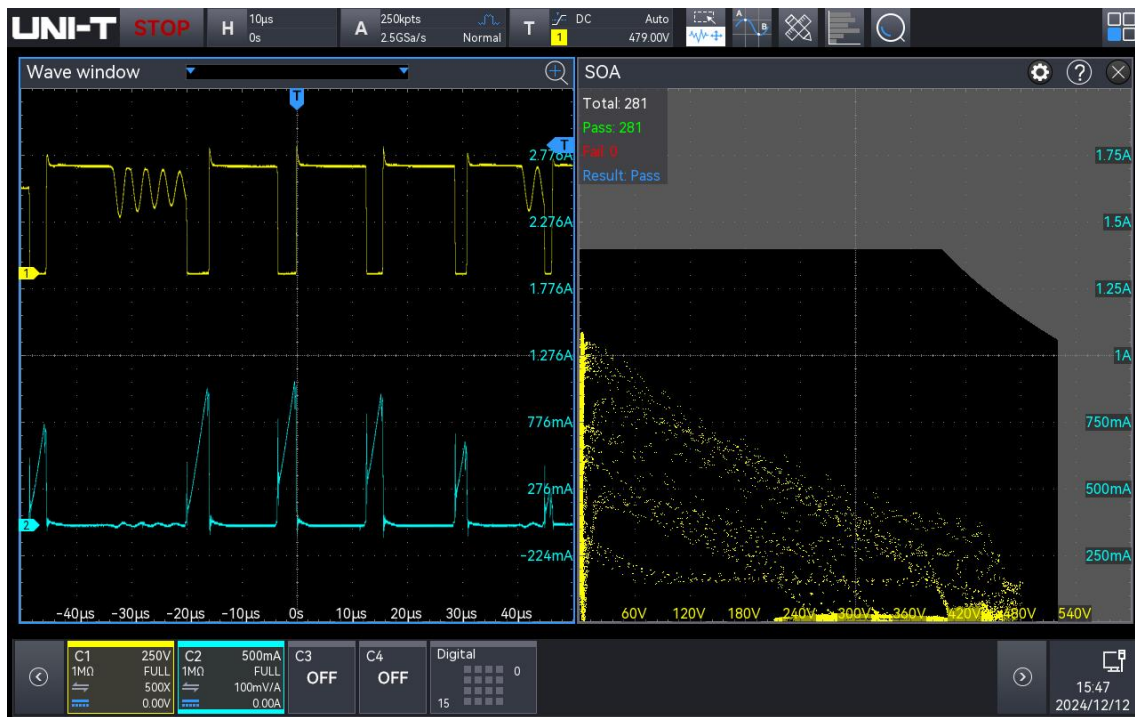

11.8. Modulation Analysis

The feedback control loop stabilizes the output voltage, while modulation analysis specifically examines the characteristics of the control loop in the switching power supply. It measures the control pulse signal of the switching device (MOSFET) and observes the trends in pulse width, duty ratio, period, frequency, rise time, fall time, and other factors in response to various events.

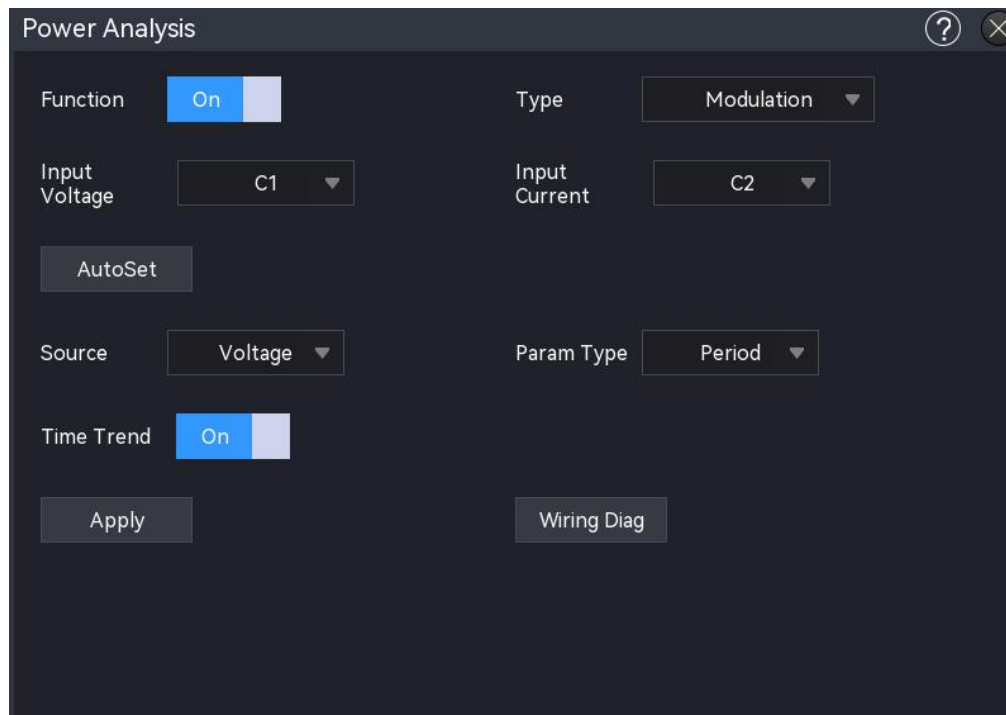

- (1) Analysis Type
Click on the “Type” to select “Modulation”.
- (2) Function Switch
Click on the “Function” to toggle the power analysis ON/OFF.
- (3) Wiring Diagram
Click on the “Wiring Diag” to display the wiring diagram of modulation analysis. Follow the instructions to make the wiring connections as shown in the figure below. Tap the icon in the top-right corner to close the wiring diagram.
 - a. Voltage Probe
 - Connect D+ to the drain of the MOSFET.
 - Connect D- to the source of the MOSFET.
 - Select an appropriate probe attenuation ratio.
 - b. Current Probe
 - Connect current probe to the source of the MOSFET. The arrow on the probe indicates the direction of the current.
 - Configure "Input Voltage" and "Input Current" to assign the corresponding channels for the probe mentioned above.

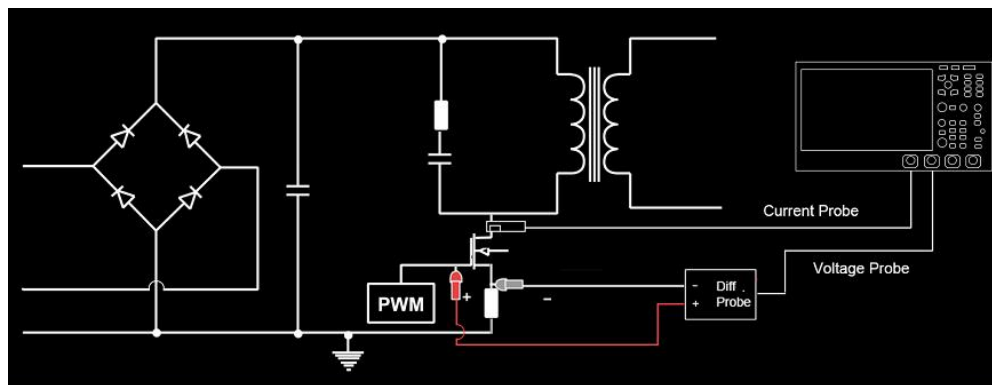

(4) Input Voltage

Click on the “Input Voltage” to select the channel to collect voltage (C1 - C4), the voltage channel should set the unit and probe attenuation ratio according to the input voltage probe.

(5) Input Current

Click on the “Input Current” to select the channel to collect current (C1 - C4), the current channel should set the unit and probe attenuation ratio according to the input current probe.

(6) Auto Setting

After configuring the input voltage and input current sources, the "AutoSet" function will automatically open the voltage and current channels, set the channel units to V and A, and close the other channels.

(7) Source Reference

Click on the “Source” to configure the measurement source as voltage or current for the modulation analysis.

(8) Parameter Type

Click on the “Param Type” to configure the measurement type, including period, frequency, rise time, fall time, positive pulse width, negative pulse width, positive duty ratio, and negative duty ratio.

(9) Time Trend

Click on the “Time Trend” to toggle the display state ON/OFF.

(10) Apply

Click on the "Apply" to enable the oscilloscope to perform the power analysis function based on the input voltage, input current, source reference, and parameter type. The time trend chart will automatically display after the analysis is complete.



The time trend graph visualizes the measured changes in each cycle of the modulation waveform using a mathematical waveform





12. Cursor Measurement

- [Time Measurement](#)
- [Voltage Measurement](#)
- [Screen Measurement](#)

Use the cursor to measure X axis (time) and Y axis (voltage) of the waveform. The cursor measurement supports simultaneous measurement of multiple channels, as well as Math wave. The source, test type and mode can be set in the cursor measurement menu.

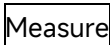
- (1) Source: set the source for the cursor measurement, C1-C4 and M1-M4 can be selected.
- (2) Test type: Time, voltage, and screen measurements.
- (3) Synchronized move: Configure the cursor time signature tracking method. It can be set to on or off.
 - OFF: The two cursors can be adjusted independently.
 - ON: The two cursors move together in a synchronized manner.
- (4) Horizontal cursor: Set the horizontal cursor position relative to the time base. Two modes can be selected: position fixed and delay fixed.
 - Position fixed: The default display is at ± 2 divisions. When the time base is changed, the positions of the AX and BX cursors on the screen remain unchanged.
 - Delay fixed: The default display is at ± 2 divisions. When the time base is modified, the AX and BX cursor positions are stretched or compressed accordingly.
- (5) Cursor result window: Supports hover or fixed display modes.
 - Hover: Allows you to drag the window to display it anywhere on the screen.
 - Fixed: Drag the window to the left side of the screen to fix its position there.

The cursor measurement can be entered using the following steps.

- Press the  key on the front panel, click on the "Cursor measurement" in the "Measure" menu to open the cursor measurement.
- Click the Home  icon in the top right corner and select the counter icon  to switch on the cursor measurement.
- If the cursor icon is added to the toolbar, click on the cursor icon  in the toolbar in the top right corner to open the cursor measurement.
- If cursor measurement results appear, click on the icon  to open the cursor measurement.

12.1. Time Measurement

In the “Cursor” menu to switch on the cursor and click on the “Type” to select “Time” and then tick on the “Source” to be tested, as shown in the following figure.

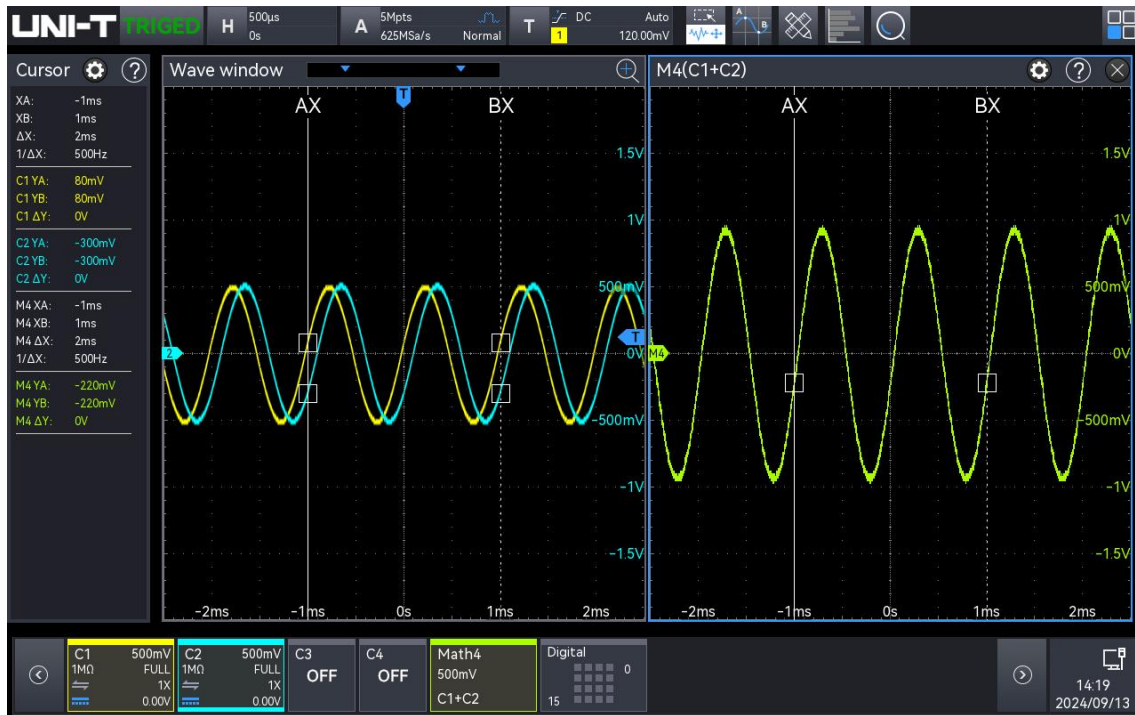

Cursor results info box: “X” represents the results of channel time measurement, “Y” represents the results of voltage measurement at the intersection of the open channel and the cursor.

Math wave supports split screen display, so when the cursor is measuring Math wave, it can also be displayed in split screen, allowing the cursor of each Math channel to be adjusted individually without affecting each other.

The position of AX and BX cursors can be set using the following methods.

- Use the Multipurpose A rotary knob to move the cursor AX position, and use the Multipurpose B rotary knob to move the cursor BX position.
Clockwise: moves to the right; anticlockwise: moves to the left.
- Tap to select AX or BX. Drag the cursor to move to the correct position, for the use of drag gesture, refer to the section of [Touch Screen](#).

12.2. Voltage Measurement

The voltage measurement is the same as the time measurement, adjusting the vertical position of the cursor and measuring the voltage of each cursor.

In the "Cursor" menu to switch on the cursor and click on the "Type" to select "Voltage" and then tick on the "Source" to be tested, as shown in the following figure.

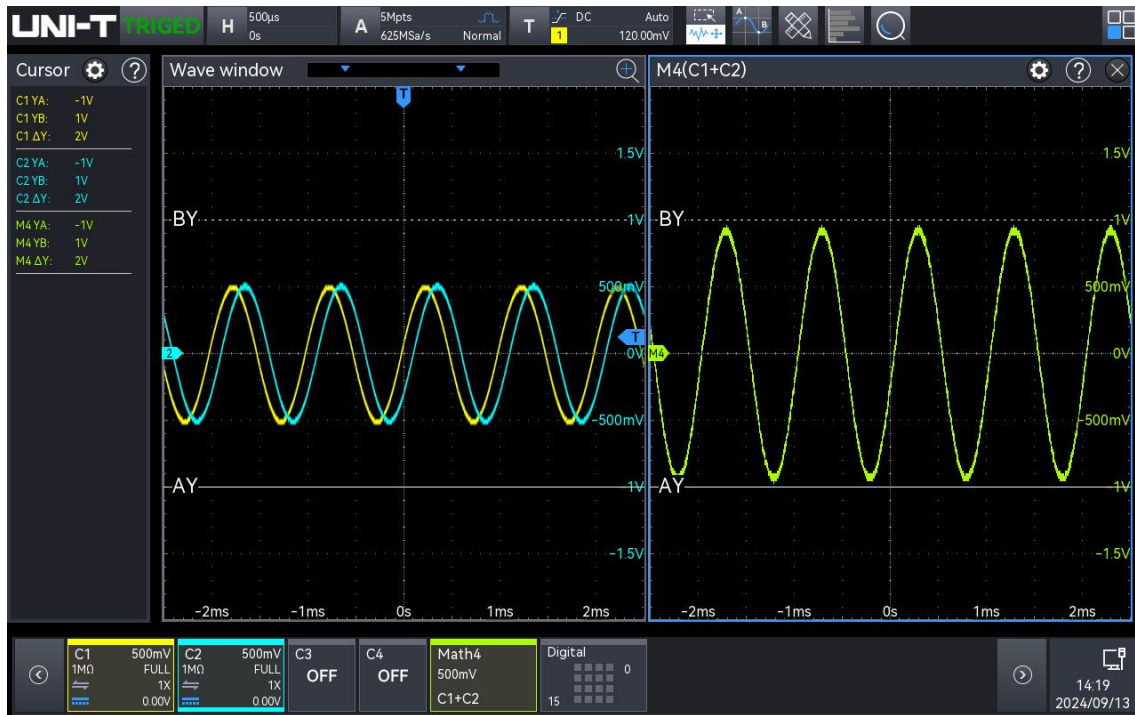

Cursor results info box in top left corner: "Y" represents the results of channel voltage measurement.

Math wave supports split screen display, so when the cursor is measuring Math wave, it can also be displayed in split screen, allowing the cursor of each Math channel to be adjusted individually without affecting each other.

The position of AY and BY cursors can be set using the following methods.

- Use the Multipurpose A rotary knob to move the cursor AX position, and use the Multipurpose B rotary knob to move the cursor BX position.
Clockwise: moves up; anticlockwise: moves down.
- Tap to select AX or BX to drag the cursor to move to the correct position, for the use of drag gesture, refer to the section of [Touch Screen](#).

12.3. Screen Measurement

The screen measurement supports setting the time cursor and voltage cursor, i.e. the time and voltage measurement can be performed at the same time.

In the "Cursor" menu to switch on the cursor and click on the "Type" to select "Screen" and then tick on the "Source" to be tested, as shown in the following figure.

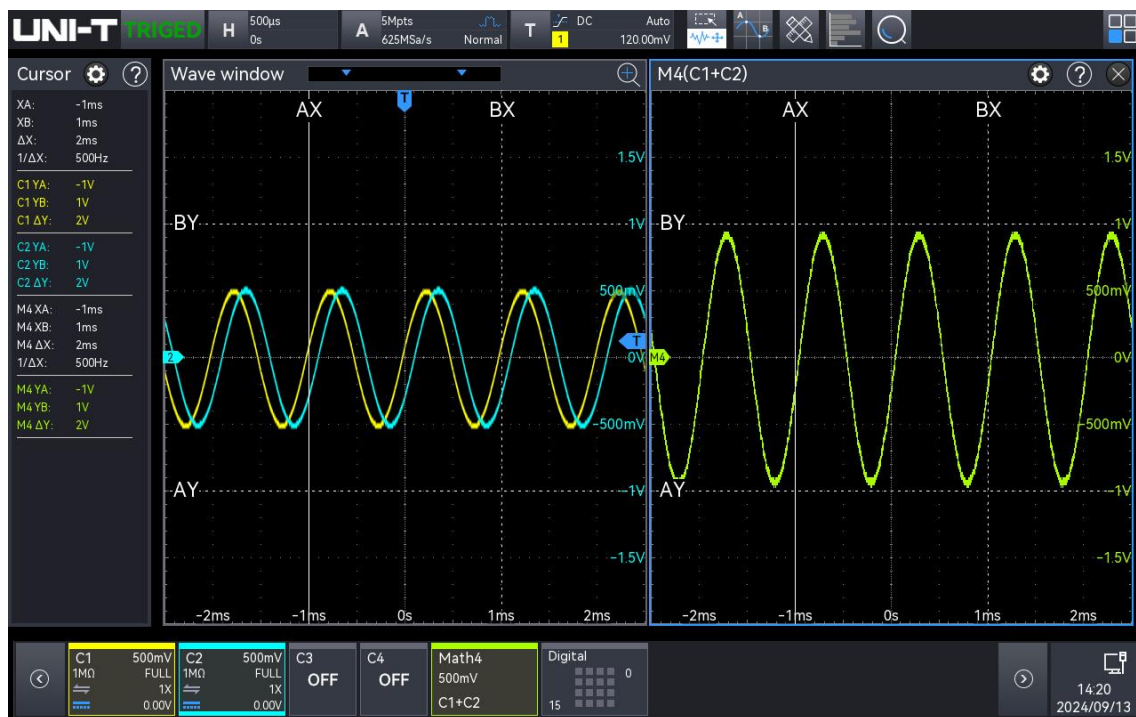

Cursor results info box in top left corner: “X” represents the results of channel time measurement, “Y” represents the results of voltage measurement.

Math wave supports split screen display, so when the cursor is measuring Math wave, it can also be displayed in split screen, allowing the cursor of each Math channel to be adjusted individually without affecting each other.

The position of AX, BX, AY, and BY cursors can be set using the following methods.

- Use the Multipurpose A rotary knob to move the cursor AX and AY position, and use the Multipurpose B rotary knob to move the cursor BX and BY position.
Clockwise: moves to the right (moves up); anticlockwise: moves to the left (moves down).
Press the Multipurpose A rotary knob to switch between AX and AY.
Press the Multipurpose B rotary knob to switch between BX and BY.
- Tap to select AX, BX, AY, or BY to drag the cursor to move to the correct position, for the use of drag gesture, refer to the section of [Touch Screen](#).

13. Sampling System

- [Sampling Rate](#)
- [Acquisition Mode](#)
- [Memory Depth](#)
- [Interpolation Method](#)
- [Enhanced Resolution \(ERES\)](#)

Sampling is the conversion of the signal from an analog input channel, through an analog-to-digital converter (ADC), into a discrete point.

The sampling setting menu can be entered using the following steps.

- Click on the **A** sampling info label at the top of the screen (as shown in the following figure) to enter the “Sampling” setting menu.

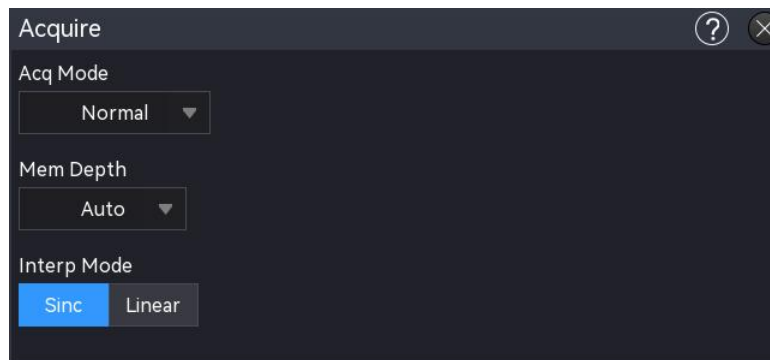

13.1. Sampling Rate

(1) Sampling and Sampling Rate

Sampling indicates that the oscilloscope is to take a sample from the input an analog signal and convert the sample to digital data, and then gathering the digital data to waveform records. The waveform records will be saved in the storage memory.

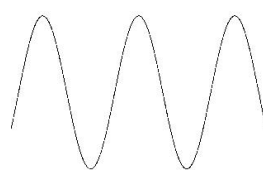

Analog Input Signal

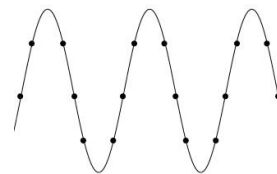

Sampling Point

Sampling rate indicates the time interval between two sampling points. The maximum sampling

rate of MSO1000HD series high-resolution oscilloscopes is 2.5 GSa/s.

The sampling rate will change with the time base scale and memory depth. The real-time sampling rate is displayed in the **A** sampling label at the top of the screen, the horizontal time base can be adjusted by using the horizontal Scale or change the "Memory Depth".

(2) Effect of Low Sampling Rate

- **Waveform distortion:** Due to low sampling rate, the details of the waveform might be missing, the sampled waveform might have large different than the actual signal, as shown in the following figure.

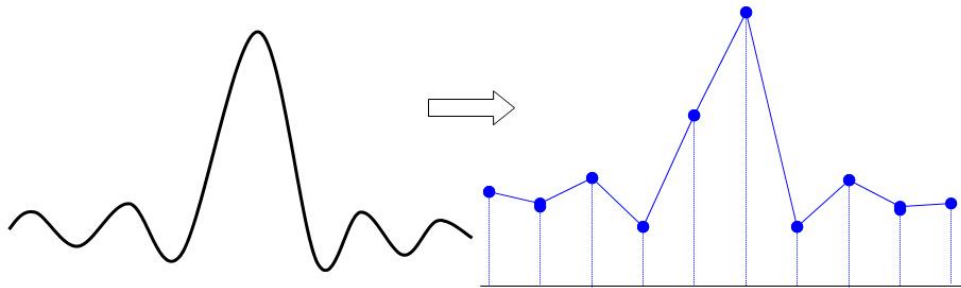

- **Waveform aliasing:** Since the sampling rate is 2 times lower than the actual signal frequency (Nyquist frequency), the waveform frequency is less than the frequency of actual signal when sampling data is reconstructing, as shown in the following figure.

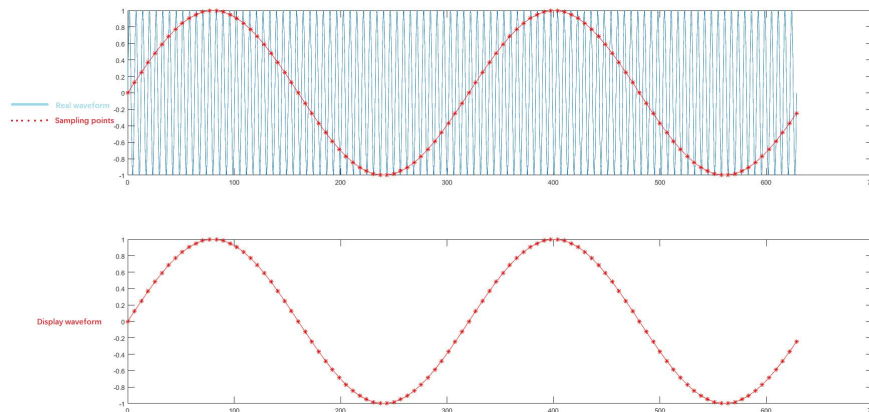

- **Waveform missing:** Due to the low sampling rate, the waveform does not reflect all the actual signals, as shown in the following figure.

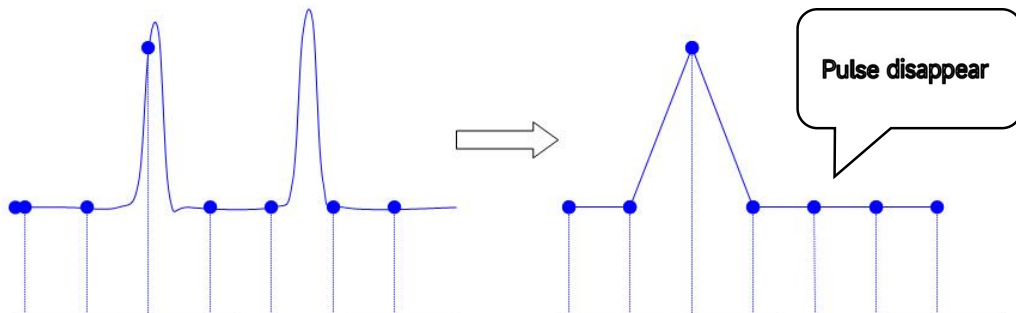

13.2. Acquisition Mode

The acquisition mode controls how the oscilloscope uses the sampling rate to create a waveform. In the “Sampling” menu, click on the “Acquisition Mode” to select the mode.

(1) Normal Sampling

The oscilloscope samples the signal and reconstructs the waveform with equal time interval in normal mode. For most of waveform, this mode can produce the optimal display effect.

(2) Peak Sampling

The oscilloscope finds the maximum and minimum of the input signal from every sampling interval and using this value to display the waveform. Thus, the oscilloscope can get and display the narrow pulse, otherwise, this narrow pulse will be missed in normal sampling. In this mode, the noise will also look larger

(3) High Resolution

The oscilloscope averages the adjacent point of sampling waveform, it can reduce the random noise of input signal and generate a smoother waveform on the screen.

(4) Average

The oscilloscope obtains several waveforms and calculates its averaged value, and then displays the final waveform. This mode can reduce the random noise.

To observe the waveform by changing the acquisition method. If the signal contains large noise, the waveform does not average and the waveform adopts 32 times averaged as shown in the following figure. The higher the average value, the lower the noise and the vertical resolution will be much higher, but the change in the waveform will also be slower.

The “Average Number” is enabled when the acquisition mode is average, and the range can be set from 2 to 8192, each increment is a power function of 2. The default averaging number of the oscilloscope is 2.

By changing the acquisition mode setting to observe the waveform changes. If the signal contains large noise, when the average mode is not adopted and when the 32 times average mode is adopted, the sampled waveform is shown in the following figure.

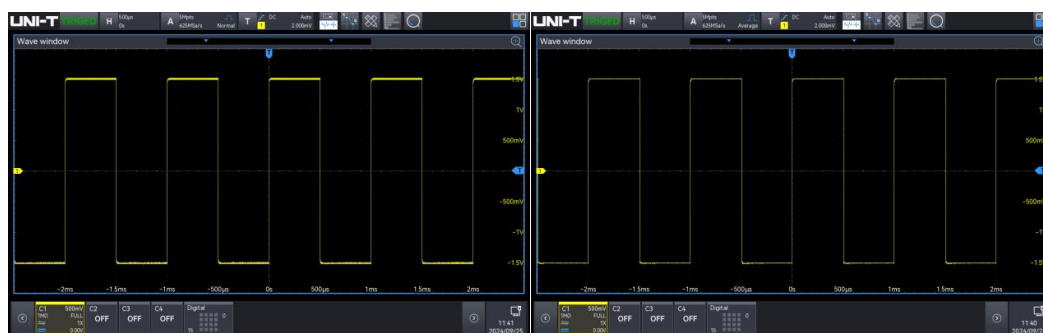

Not Averaged Waveform

Waveform of 32 Times Averaged

Note: Average and high resolution uses different average methods. The former is “multiple sampling averaged”, the latter is “single sampling averaged”.

(5) Enhanced Resolution

If the signal-to-noise ratio and the effective resolution of the oscilloscope need improvement, select the enhanced resolution acquisition method, then set the desired number of enhanced resolution bits. For more details, refer to the section of [13.5 Enhanced Resolution \(ERES\)](#).

13.3. Memory Depth

The memory depth is the number of waveforms that can be stored in the oscilloscope during a trigger acquisition. It reflects the memory storage capacity of the memorizer.

The relation of the memory depth, sampling rate and sampling time:

$$\text{Memory depth} = \text{Sampling rate (Sa/s)} \times \text{Sampling time (s/div} \times \text{div)}$$

In the “Sampling” menu, click on the “Memory Depth” to select the memory depth. The real-time memory depth is displayed in the **A** sampling label at the top of the screen.

MSO1000HD supports the memory depth as shown in the table below: Auto (5 Mpts), 25 kpts, 250 kpts, 500 kpts, 5 Mpts, 50 Mpts, 100 Mpts

13.4. Interpolation Method

With real-time sampling, the oscilloscope acquires discrete samples of the displayed waveform. In general, waveforms displayed by dots are difficult to observe. The digital oscilloscope usually uses interpolation to improve the visualization of the signal. The interpolation is a method of “connect each sampling point” and using some points to calculate the waveform. With real-time sampling using interpolation, even if the oscilloscope only captures a small number of sampling points in a single pass, interpolation can be used to fill in the gaps between points and reconstruct an accurate waveform.

The interpolation is divided into Sinc interpolation ($\text{sinc}(x)$) and linear interpolation.

Linear interpolation: Straight lines are directly connected at adjacent sampling points. This method is limited to the reconstruction of pure edge signals, such as square waves.

Sinc interpolation ($\text{sinc}(x)$): Use a curve to connect the sampling points, this is more common.

Sinc interpolation uses mathematical processing to calculate the result in the actual sampling point interval. This method bends the signal waveform to produce a more realistic common shape than pure square waves and pulses. When the sampling rate is 3 to 5 times the system bandwidth. Sinc interpolation is recommended. The figure below shows a very different display using the two

interpolation methods.

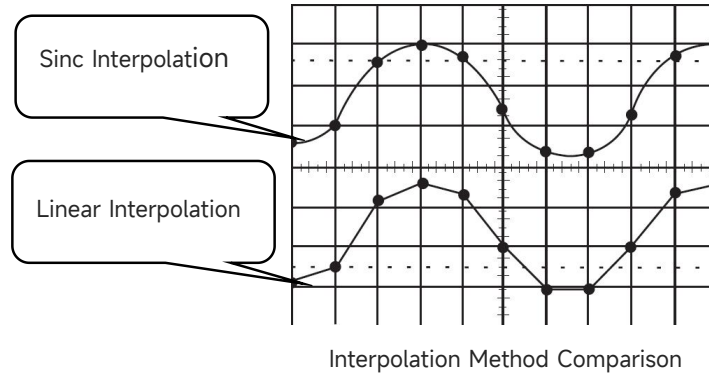

13.5. Enhanced Resolution (ERES)

In Enhanced Resolution mode, the oscilloscope digitally filters the sampling points, reducing broadband random noise on the input signal and improving the signal-to-noise ratio, thereby increasing the effective resolution (ENOB) of the oscilloscope. MSO1000HD ERES processing is implemented by a hardware engine, allowing the oscilloscope to maintain a high waveform refresh rate even when Eres is enabled.



Unlike other acquisition methods, Eres does not require the signal to be periodic or triggered stably. However, because it relies on digital filtering, enabling Eres reduces the oscilloscope's system bandwidth. The higher the number of enhanced resolution bits, the lower the bandwidth. The table below shows the relationship between the number of Eres bits and the resulting bandwidth.

Eres Bit	- 3 dB Bandwidth
1 bit	0.6*Sampling rate
1.5 bits	0.2* Sampling rate
2 bits	0.1* Sampling rate
2.5 bits	0.032* Sampling rate
3 bits	0.012* Sampling rate
4 bits	0.005* Sampling rate

14. Display System

In the "Display" menu, set the waveform type, persistence, grid type, waveform brightness, backlight brightness, and window transparency.

The "Display" menu can be entered using the following steps.

- Click the Home icon  in the top right corner and select the display icon  to switch on the display menu.
- If the display function is added to the toolbar, click the display icon  in the toolbar in the top right corner to enter the display menu.

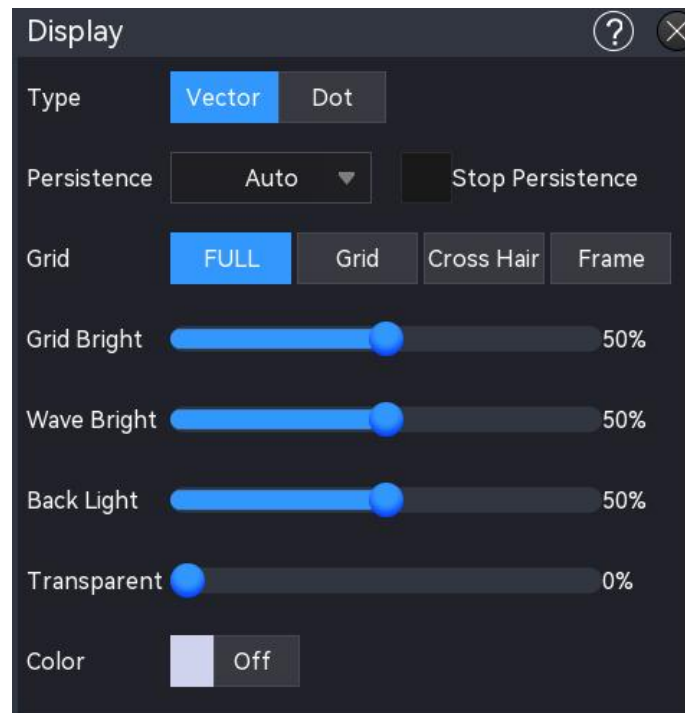

14.1. Display Type

In the "Display" setting menu, the display type can be set to vector or point. The default setting is vector display.

- Vector display: The sampling points are shown in the connecting line. This mode provides the most realistic waveform in most cases and makes it easy to view the steep edges of the waveform (e.g. square wave).
- Point display: Directly display the sampling point.

14.2. Persistence

Set the persistence in the “Display” menu, once the persistence is enabled, the oscilloscope uses the new acquired waveform to refresh the display but will not immediately delete the old acquired waveform. The old acquired waveform is displayed with the low brightness color, and the new acquired waveform is displayed with the normal color and brightness.

The persistence can set to auto, 50 ms, 100 ms, 200 ms, 5W00 ms, 1 s, 2s, 5 s, 10 s, 20 s, infinite, and off. The default is auto.

- Auto: When the trigger type is set to decoding type, the waveform is automatically displayed as a single amplitude.
- Adjustable persistence (50 ms..10 s, 20 s): In different persistence, the oscilloscope updates the display with the newly acquired waveforms, and the acquired waveforms are cleared after the appropriate time. Glitch with slower changes or lower probability of occurrence can be observed.
- Infinite: Once “Infinite” is selected, the oscilloscope never clears the acquired waveform. Use infinite persistence to measure noise and jitter, and to capture episodic events.
- OFF: Only a single amplitude waveform is displayed without persistence.
- Stop persistence: When the “Stop Persistence” is checked, the persistence effect remains on the screen after the oscilloscope is stopped. When “Stop Persistence” is unchecked, only a single waveform is displayed on the screen without the persistence effect.

14.3. Grid Type

In the “Display” setting menu, four grid type can be set: grid display, full display, frame, and crosshair.

- Grid: Displays a grid with 8 rows and 14 columns.
- Full scale: Displays in crosshair and grid.
- Frame: No crosshair, no grid display.
- Crosshair: Divides the screen into 4 parts.

14.4. Grid Brightness

In the “Display” menu, rotate the Multipurpose A rotary knob or drag the scroll bar to set the grid brightness.

The brightness range: 0%-100%. The default is 50%.

14.5. Waveform Brightness

In the “Display” menu, rotate the Multipurpose A rotary knob or drag the scroll bar to set the waveform brightness.

The brightness range: 0%-100%. The default is 50%.

14.6. Backlight Brightness

In the “Display” menu, rotate the Multipurpose A rotary knob or drag the scroll bar to set the backlight brightness.

The brightness range: 0%-100%. The default is 50%.

14.7. Window Transparence

Set the window transparence for all pop-up info box (e.g. Cursor menu, Waveform view menu, etc.), set to the appropriate value for a better view of the measured data. Rotate the Multipurpose A rotary knob or drag the scroll bar to set the window transparency

The brightness range: 0%-100%, 0% represents non-transparent, 100% represents fully transparent, and the default is 50%.

Note: The auxiliary window is non-transparent by default.

14.8. Color Temperature

Switch on/off “color temperature” in the “Display” menu, the default setting is OFF.

Once the color temperature is displayed, the different color represents the number of data acquired or the probability on the screen.

15. Save and Load

- [Save Menu](#)
- [Save Waveform](#)
- [Save Setting](#)
- [Save Picture](#)
- [Load Setting](#)
- [File Browser](#)

Users can save the current oscilloscope settings, waveforms, screen images and parameters in various formats to internal memory or external USB storage devices (e.g. USB) and reload the saved settings or waveforms as required. It is also possible to load the updated version of the software into the system to upgrade the instrument. In addition, the user can copy, delete and rename files of specified types in internal memory or external USB memory using the Disk manager menu.

Note: This oscilloscope has 1 USB HOST ports on the front panel for connecting a USB flash drive to perform external storage

15.1. Save Menu

The save setting menu can be entered using the following steps.

- Click the Home icon in the top right corner and select the save icon to enter the save setting menu.
- If the save function is added into the toolbar, click the counter icon  in the toolbar in the top right corner to enter the save setting menu. The save setting menu has two sub-menu "Save" and "Load", please select the sub-menu to set.

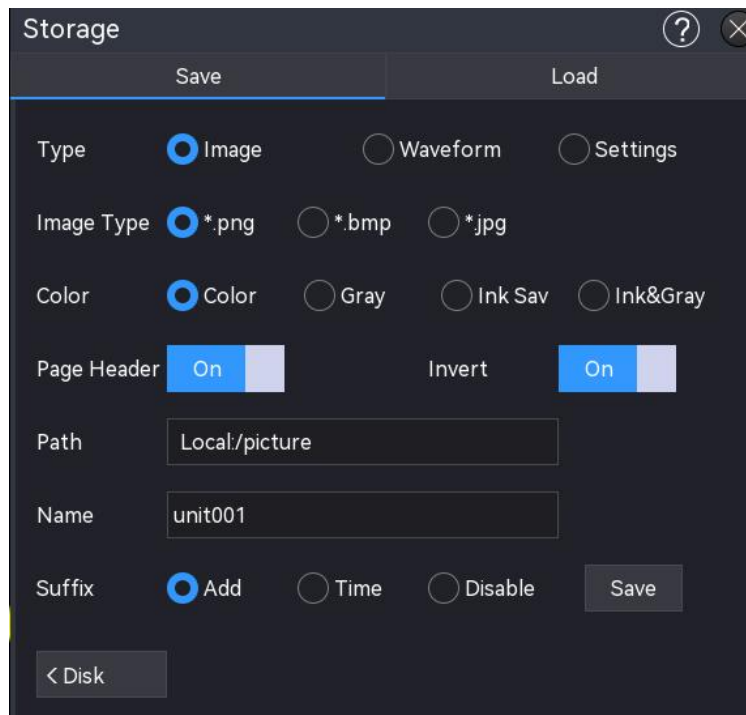

15.2. Save Waveform

Enter the submenu of “Save” to select “Save Waveform” to enter the setting menu, the channel that has selected source (vertical scale, horizontal time base) can be saved to internal or external storage.

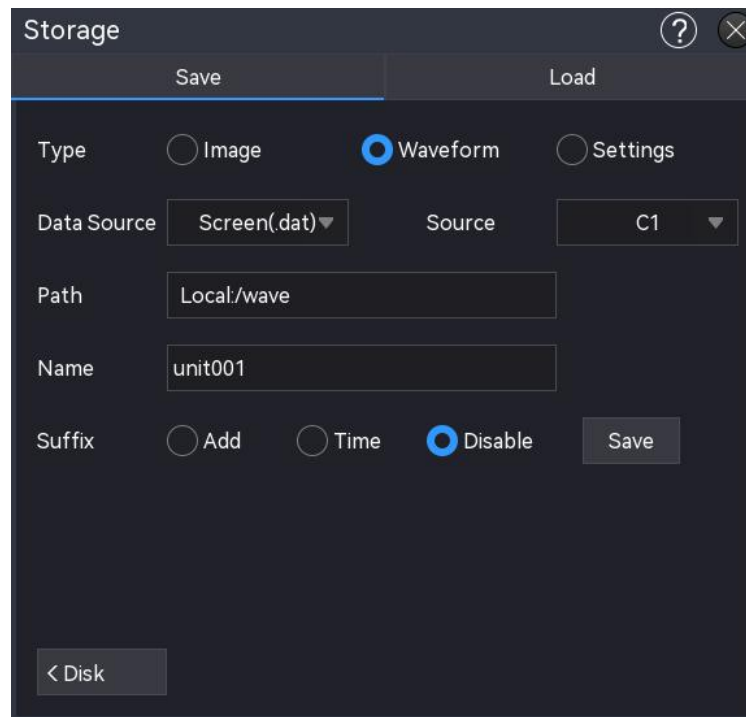

Waveform setting menu: data type, source, save path, filename, and suffix.

(1) Data Type

Click on the "Data Type" to select the data type of the waveform to be saved, it has three kinds of screen (.dat), deep memory (.csv), and arbitrary wave (.bsv). Screen (.dat) and deep memory (.csv) files can be opened using the host software analyzer. Additionally, arbitrary waveforms (.bsv) can be loaded into either the signal source or the oscilloscope's generator.

(2) Source

Click on the "Source" to select the source of waveform to be saved. For waveform data storage, only open sources are supported. When saving .dat and .bsv, the source can select C1 - C4 and M1 - M4. When saving ".csv", the source can select C1 - C4, M1 - M4, Digital, or analog channel.

(3) Save Path

Double-click on "Save Path" input field to open the file browser menu, and select the save directory in the file browser menu, then click "Enter" key to set the save path. For the use of file browser, refer to the section of [File Browser](#). When a USB flash drive is not connected, the default save path is the local disk "Local:/wave". When a USB flash drive is detected, "UDISK:" is selected as the default save path.

(4) Filename

Double-click on the "Filename" input field to open the numeric keypad to set the filename. For details on the use of the numeric keypad, refer to "Enter Character String" in the section of [5.8 Parameter Setting](#).

(5) Suffix

Tap to select the suffix to "Forbid", "Time", or "Accumulate". The filename of the picture will be saved with the selected suffix to the internal or external storage.

- Forbid: Saved with the filename and not add a suffix.
- Time: Add the current system time as the suffix for the filename to be saved.
- Accumulate: Add the accumulated number as the suffix for the filename to be saved, the number starting from 0001 to accumulate.

(6) Save Time Setting

Time saving means adding a time column to the saved CSV file, which can be set when choosing CSV as the data source (not supported by the Digital signal source). When the "Time Save" checkbox is checked, the saved CSV file will contain both time and voltage columns; when unchecked, the saved CSV file will contain only the voltage column.

(7) Disk Manager

Click on the "Disk Manager" to jump to the file browser, for the use of file browser, refer to the section of [File Browser](#).

(8) Save

Click on the “Save”, the system will save the waveform file according to the current setting and display a saving result hint

15.3. Save Setting

Enter the submenu of “Save” to select “Save Setting” to enter the setting menu, the oscilloscope will save the setting with the format of “.set” to internal or external storage. The saved setting can be loaded as required.

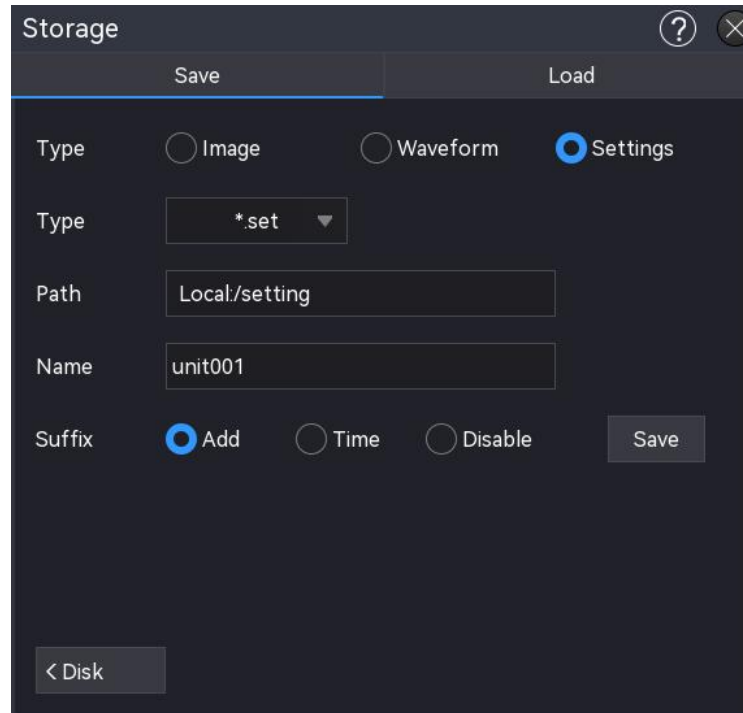

Save setting menu: file type, source, save path, filename, and suffix.

(1) File Type

Click on the “Data Type” to select the data type of waveform to be saved, *.set can be selected.

(2) Save Path

Double-click on “Save Path” input field to open the file browser menu, and select the save directory in the file browser menu, then click “Enter” key to set the save path. For the use of file browser, refer to the section of [File Browser](#). When a USB flash drive is not connected, the default save path is the local disk “Local:/wave”. When a USB flash drive is detected, “UDISK:” is selected as the default save path.

(3) Filename

Double-click on the “Filename” input field to open the numeric keypad to set the filename. For details on the use of the numeric keypad, refer to “Enter Character String” in the section of [5.8 Parameter Setting](#).

(4) Suffix

Tap to select the suffix to “Forbid”, “Time”, or “Accumulate”. The filename of the picture will be saved with the selected suffix to the internal or external storage.

- Forbid: Saved with the filename and not add a suffix.
- Time: Add the current system time as the suffix for the filename to be saved.
- Accumulate: Add the accumulated number as the suffix for the filename to be saved, the number starting from 0001 to accumulate.

(5) Disk Manager

Click on the “Disk Manager” to jump to the file browser, for the use of file browser, refer to the section of [File Browser](#).

(6) Save

Click on the “Save”, the system will save the setting file according to the current setting and display a saving result hint.

15.4. Save Picture

Enter the submenu of “Save” to select “Save Picture” to enter the setting menu, the oscilloscope will save the picture according to the setting to internal or external storage.

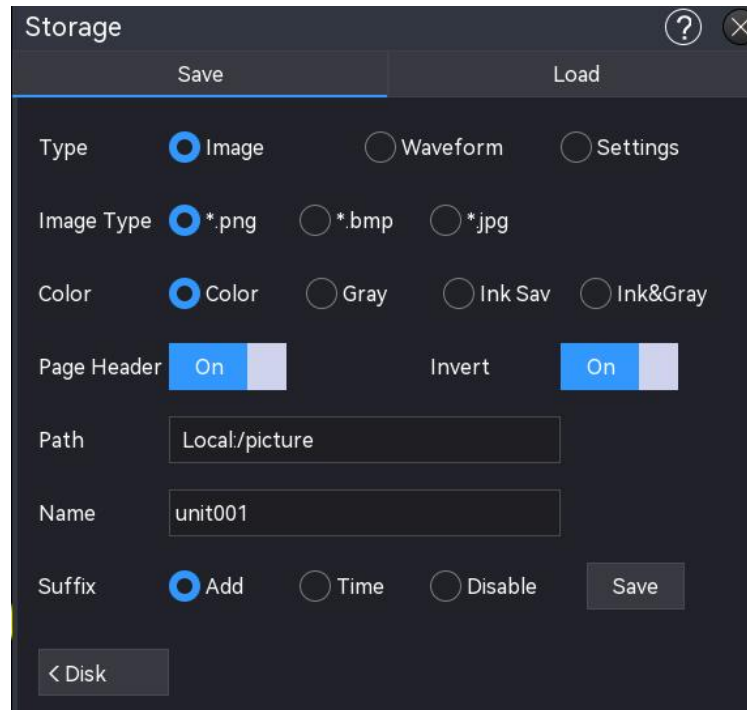

Picture save setting menu: picture type, color, page header, inverse color, save path, filename, and suffix.

(1) Picture Type

Click on the “Picture Type” to select the format to “.png”, “.bmp”, or “.jpg”. The screen image will be saved with the selected format to internal or external storage.

(2) Color

Click on the “Color” to select the picture color to be saved.

Color	The oscilloscope's screenshot will be saved with the displayed color.
Save ink	The oscilloscope's screenshot will change the dark background to light color and be saved, this is to save ink.
Grey	The oscilloscope's screenshot will change color to grey and be saved.
Grey & Save ink	The oscilloscope's screenshot will change the dark background to light color and change the color to grey and be saved.

(3) Page Header

Click on the “Page Header” to switch on/off the page header.

ON: The instrument model and image data will be displayed in the page header.

OFF: No information is displayed in the page header.

(4) Inverse Color

Click on the “Inverse Color” to switch on/off the inverse color function.

(5) Save Path

Double-click on “Save Path” input field to open the file browser menu and select the save directory in the file browser menu, then click “Enter” key to set the save path. For the use of file browser, refer to the section of [File Browser](#). When a USB flash drive is not connected, the default save path is the local disk “Local:/wave”. When a USB flash drive is detected, “UDISK:” is selected as the default save path

(6) Filename

Double-click on the “Filename” input field to open the numeric keypad to set the filename. For details on the use of the numeric keypad, refer to “Enter Character String” in the section of [5.8 Parameter Setting](#).

(7) Suffix

Tap to select the suffix to “Forbid”, “Time”, or “Accumulate”. The filename of the picture will be saved with the selected suffix to the internal or external storage.

- Forbid: Saved with the filename and not add a suffix
- Time: Add the current system time as the suffix for the filename to be saved.
- Accumulate: Add the accumulated number as the suffix for the filename to be saved, the number starting from 0001 to accumulate.

(8) Disk Manager

Click on the “Disk Manager” to jump to the file browser, for the use of file browser, refer to the

section of [File Browser](#).

(9) Save

Click on the “Save”, the system will save the picture file according to the current setting and display a saving result hint.

15.5. Load Setting

Enter the submenu of “Save” to select “Load Setting” to enter the setting menu, to load the saved setting file to the oscilloscope.

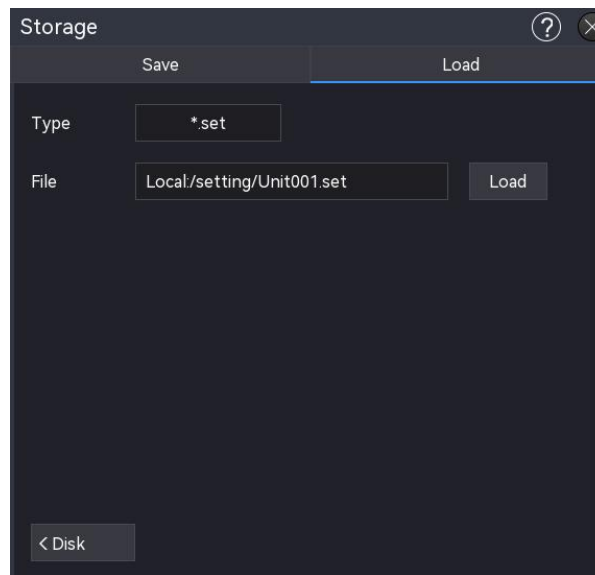

(1) File Type

Select the type of loading setting file, the default type is “.set”, and cannot be changed.

(2) File

Click on the “Browse” to enter the file browser and select the setting file to be loaded. For the use of file browser, refer to the section of [File Browser](#).

(3) Load

Click on the “Load” to load the selected setting file.

(4) Disk Manager

Click on the “Disk Manager” to jump to the file browser, for the use of file browser, refer to the section of [File Browser](#).

15.6. File Browser

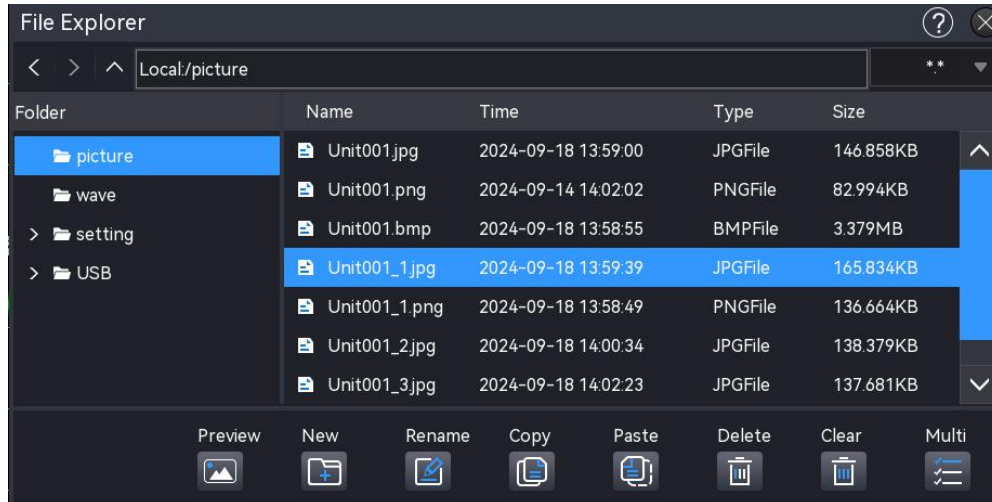

Enter the “Save” menu and to select “Disk Manager” at the bottom left corner to enter the disk

manager menu, as shown in the following figure



(1) Select Disk

Before connecting an external storage, please make sure that USB (FAT32, Flash) is correctly connected. The save interface displays the contents of Local by default. If an external storage is connected, click the hardware icon in the top left in the “Save” menu to select “Local”, or “USB”. If “USB” is selected, the save interface will display the contents of USB.

After selecting a file path, press the key ,  in the upper left corner of the popup box to undo the path selection, or press the key  to navigate to the previous directory.

Note: The USB name appears as the USB flash drive's name and cannot be modified.

(2) Preview

To preview locally saved images, select an image and click 'Preview.' If you have more than one image, you can click '<' on the left side and '>' on the right side to switch between them.

(3) New File

Click on the icon  to open the numeric keypad to add a new file and enter the new filename. For details on the use of the numeric keypad, refer to “Enter Character String” in the section of [5.8 Parameter Setting](#).

(4) Rename File or Directory

Click on the icon  to open the numeric keypad to rename the file or directory.

(5) Copy File to the Specified Directory

Select the specified file or file folder, click on the copy icon  and enter the specified file folder and then click the paste to complete this setting.

(6) Paste

Select the specified file or file folder, click on the paste icon  to copy the file or file folder to the specified file folder.



(7) Delete

In the current directory, tick on the file or directory to be deleted, and click on the delete icon , and then click on the "Enter" to complete this setting, click on the "Cancel" to cancel this setting.

(8) Delete All

Delete all files and file folders in the current directory. Click on the delete icon  and then click on the "Enter" to complete this setting, click on the "Cancel" to cancel this setting.

(9) Multiple Choice

This oscilloscope supports selecting multiple files or file folders at the same time. Click the multiple-choice icon , click the check box to the right of the file, and it will be displayed in the selected state  when the selection is complete, and then deselect it by clicking the check box again, and the check box will return to its original state . You can also select all files and directories under the current disc by clicking the check box in the top right corner of the menu. Clicking the check box again will cancel the Select All operation.



(10) Suffix Type

Click on the "File browser" in the top right corner and select the suffix type, *.*, .png, .bmp, .jpg, .csv, .bsv, .dat, or .set, *.* represents all file types.

16. Reference Waveform

During the actual test, the user can compare the signal waveform with the reference waveform to determine the cause of the fault.

The reference waveform can be entered using the following steps.

- Press the **Ref** key on the front panel to enter the reference waveform setting menu.
- Click the Home icon  in the top right corner and select the reference icon  to enter the reference waveform.
- If the reference waveform is added to the toolbar, click the reference icon  to enter the reference waveform.

This oscilloscope provides 4 reference waveforms (RefA-RefD), the setting of each reference waveform is the same. This chapter describes how to set the reference waveform using RefA as an example.

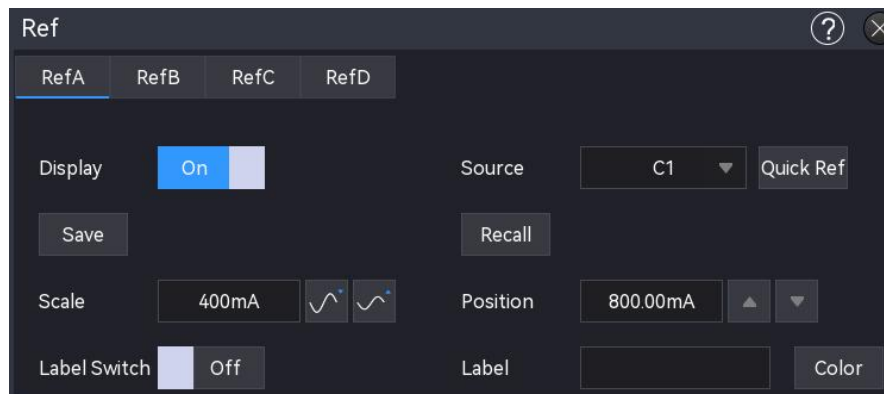

16.1. Display

Click on the “Display” to switch on/off the display of reference waveform.

16.2. Source

Click on the “Source” to select the source of waveform to be saved. Only the opened sources are supported to save waveform data, C1 - C4, M1 - M4 can be selected.

16.3. Save

- (1) File Path

Double-click on the “File Path” input field to open the file browser menu, and select the save

catalogue in the file browser menu, then click “Enter” key to set the save path. For the use of file browser, refer to the section of [File Browser](#). When a USB flash drive is not connected, the default save path is the local disk “Local:/wave”. When a USB flash drive is detected, “UDISK:” is selected as the default save path.

(2) Filename

Double-click on the “Filename” input field to open the numeric keypad to set the filename. For details on the use of the numeric keypad, refer to “Enter Character String” in the section of [5.8 Parameter Setting](#).

(3) Waveform Type

The default waveform type is *.dat, and cannot be changed.

16.4. Load



Click on the “Browse” to open the file browser menu and click the waveform file to be loaded. Click on the “Import” to load the selected waveform file. Tap on the “Import” menu, the recently 5 load file records will be displayed, the record can also be selected to load.

16.5. Quick Reference

Click on the “Quick reference” to load the currently selected source for reference but will not save the waveform file.dat. The Quick Reference function is only available for the current source, it should be re-selected after deletion.

16.6. Vertical Scale

Set the vertical scale of Ref wave in the display window, it can be set using the following steps.



- In “Ref” menu, click on the “Vertical scale” input field, rotate the Multipurpose A rotary knob on the front panel to change the vertical scale.
- Tap the vertical scale icon ,  on the right to increase or decrease the vertical scale.
- Click on the number input field to open the numeric keypad to enter the specified numeric value.

16.7. Vertical Position

Set the vertical offset of Ref wave in the display window, it can be set using the following steps.

- In “Ref” menu, click on the “Vertical position” input field, rotate the Multipurpose A rotary knob

on the front panel to change the vertical position.

- Tap the arrow key ,  on the right of the vertical position to increase or decrease the vertical position.
- Click on the number input field to open the numeric keypad to enter the specified numeric value.

16.8. Label

Click on the “Label” to switch on/off the channel label. The label can be customized, double-click on the “Label” input field to open the numeric keypad to enter the character string.





16.9. Channel Color

Set the color for the Ref waveform and label. Click on the “Channel Color” to enter the setting menu.

- Source: Click on the “Source” to select the source to set the color, the source can select M1, M2, M3, M4, R1, R2, R3, or R4.
- Color: Tap the color plate and drag to select the color.

17. Utility Function

Set the system function in the “Utility” menu. The utility menu can be entered using the following steps.

- Click the Home icon  in the top right corner and select the utility icon  to enter the utility setting menu.
- If the utility function is added into the toolbar, click the utility icon  in the toolbar in the top right corner to enter the utility setting menu.

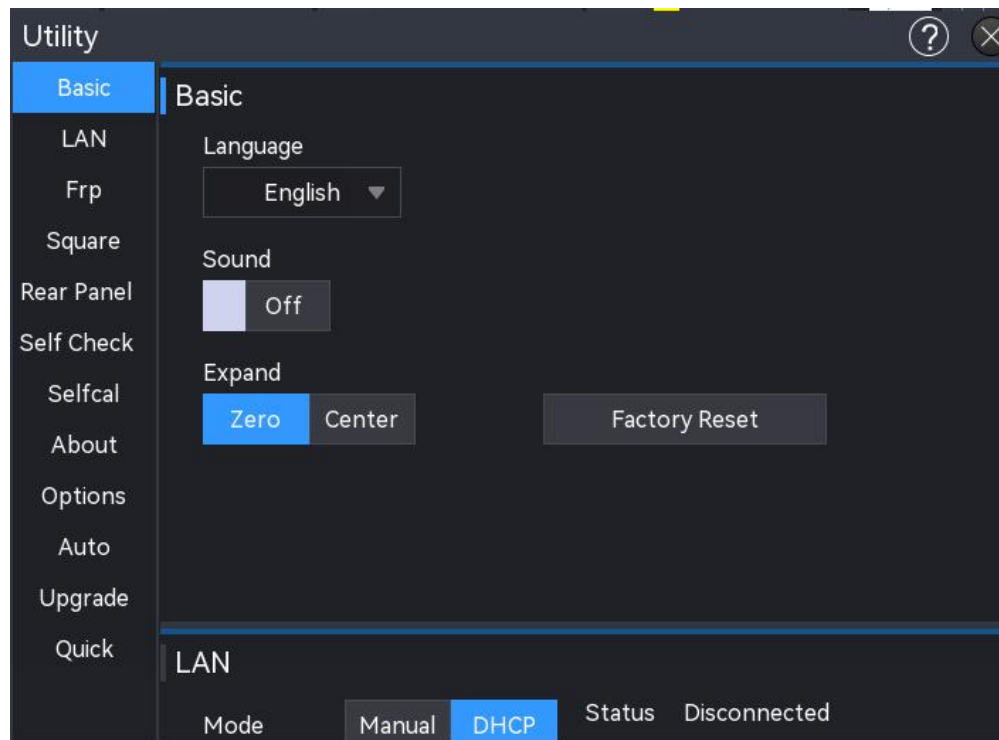

17.1. Basic Information

The basic information includes language, restore setting, sound, power-on state, and vertical extension.

(1) Language

Click on the “Language” to set the system language to English, simplified Chinese, or traditional Chinese, Italian, Spanish, French, German or Polish.

(2) Restore Setting

Click on the “Factory Setting”, the oscilloscope will restore to the factory settings and all local files will be deleted.

(3) Sound

Click on the “Sound” to switch on/off the beep. When the sound is on, a buzzer sounds when the following operations or actions are performed.

- Press the key on the front panel or menu key
- Use the touch screen function
- Prompt a message

(4) Power-on State

Set the power-on mode of the oscilloscope, it can set always off, always on and last status.

- Always off: When the power switch on the rear panel is turned on, the oscilloscope can only be opened by manually pressing the power softkey on the front panel.
- Always on: The oscilloscope can be opened directly when the power switch on the rear panel is switched on.
- Last status: When the rear panel power switch is switched on, the oscilloscope restarts according to the last shutdown state; if the last shutdown was via the power softkey, the oscilloscope should switch on via the power softkey; if the last shutdown was via direct power down, the oscilloscope can be opened directly.

(5) Vertical Extension

Click the vertical extension for the waveform.

- Screen center: When changing the vertical scale, the waveform will be extended or compressed around the screen center.
- Channel's zero position: When changing the vertical scale, the waveform will be extended or compressed around the channel's zero position.

17.2. Network Setting

When the device is connected with available internet, IP setting is used to set the IP, subnet mask, gateway, and DNS address of the oscilloscope.

(1) IP Mode

Set the IP acquire mode, it can set to manual or auto (DHCP).

- Manual: Manually set IP address, subnet mask, gateway address, and DNS address.
- Auto (DHCP): Only for checking IP address, subnet mask, gateway address, and DNS address.
 - a. IP Address: IP address format is nnn.nnn.nnn.nnn. The first nnn range is from 1 to 233, and the second nnn range is from 0 to 255. It is recommended that users can consult network administrators for an available IP address.
 - b. Subnet mask: The format is nnn.nnn.nnn.nnn. The nnn range is from 0 to 255. It is

recommended that users can consult network administrator for an available subnet mask.

- c. Gateway address: The format is nnn.nnn.nnn.nnn. The first nnn range is from 1 to 255, and the second nnn range is from 0 to 255. It is recommended that users can consult network administrators for an available gateway address.
- d. DNS address: The format is nnn.nnn.nnn.nnn. The first nnn range is from 1 to 255, and the second nnn range is from 0 to 255. It is recommended that users can consult network administrator for an available DNS address.

(2) Apply

After manually editing the IP address, subnet mask, gateway address and DNS address information, click on the "Apply" to complete the setting.

(3) LAN Reset

If you want to clear the IP address, subnet mask, gateway address and DNS address, click on the "LAN Reset" to clear the edited IP address, subnet mask, gateway address, and DNS address.

17.3. Frp Setting

To configure external network access, click "Apply" after entering the settings. You can then continue to access the network using the new FRP proxy IP address information that you modified (assuming the configuration is correct).

(1) IP Setting

- a. Frp_ip address: IP address format is nnn.nnn.nnn.nnn. The first nnn range is from 1 to 233, and the other three nnn range is from 0 to 255. It is recommended that users can consult network administrators for an available IP address.
- b. Web port range: 1000 – 65535, default: 9005.
- c. Control port range: 1000 – 65535, default: 9006.
- d. Picture port range: 1000 – 65535, default: 9007.

(2) Apply

After manually editing the IP address, port, control port, and picture port information, click "Apply" to complete the settings.

(3) Reset

If you want to clear the IP address, port, control port, and picture port information, click 'Reset' to remove the edited details.

Note: This machine uses frp intranet penetration to enable extranet access. It utilizes version 0.34.0

of frp, with this machine operating as a client. To function properly, the client must connect to a server that has frp server running. The client connects to the frp server via port 7000, so the server needs to be configured with bind_port = 7000. If multiple oscilloscopes are connected to the same frp server, the web port, picture port, and control port for each oscilloscope must be unique; otherwise, the frp proxy will fail and become inaccessible. If the frp proxy settings are modified, it will not be possible to access the device through LAN at ip:9000. To restore normal LAN access, press the **Default** button on the oscilloscope panel to reset the configuration, after which access via port 9000 can resume.

17.4. Square Selection

This oscilloscope has a square output port corresponding to the Probe Comp on the front panel. The ports support frequency selection as shown in the table below. The default frequency is 1 kHz.

Port	Frequency
Port	10 Hz, 100 Hz, 1 kHz, 10 kHz, 100 kHz, 3V_REF

17.5. Rear Panel

In the auxiliary menu, click on the "Rear panel" or drag the content to enter the rear panel setting
AUX Output

AUX output is used to select the output signal for the [AUX Out] connector on the rear panel.

- Output: Every time the oscilloscope generates a trigger, a signal reflecting the current capture signal of the oscilloscope is output from the [AUX Out] connector on the rear panel. When this signal is connected to the waveform display and device and measure the frequency of this signal, the measured result is the same as the current capture signal.
- Pass/Fail: In a pass/fail test, a positive or negative pulse is output from the rear panel [AUX Out] connector when the oscilloscope detects a pass or fail event.

17.6. Self-inspection

(1) Keyboard Self-inspection

Keypad detection is mainly used to detect when the front panel keys or knobs of the oscilloscope are not responding or are not responding sensitively. Press the self-inspection key, the oscilloscope will enter the following figure.

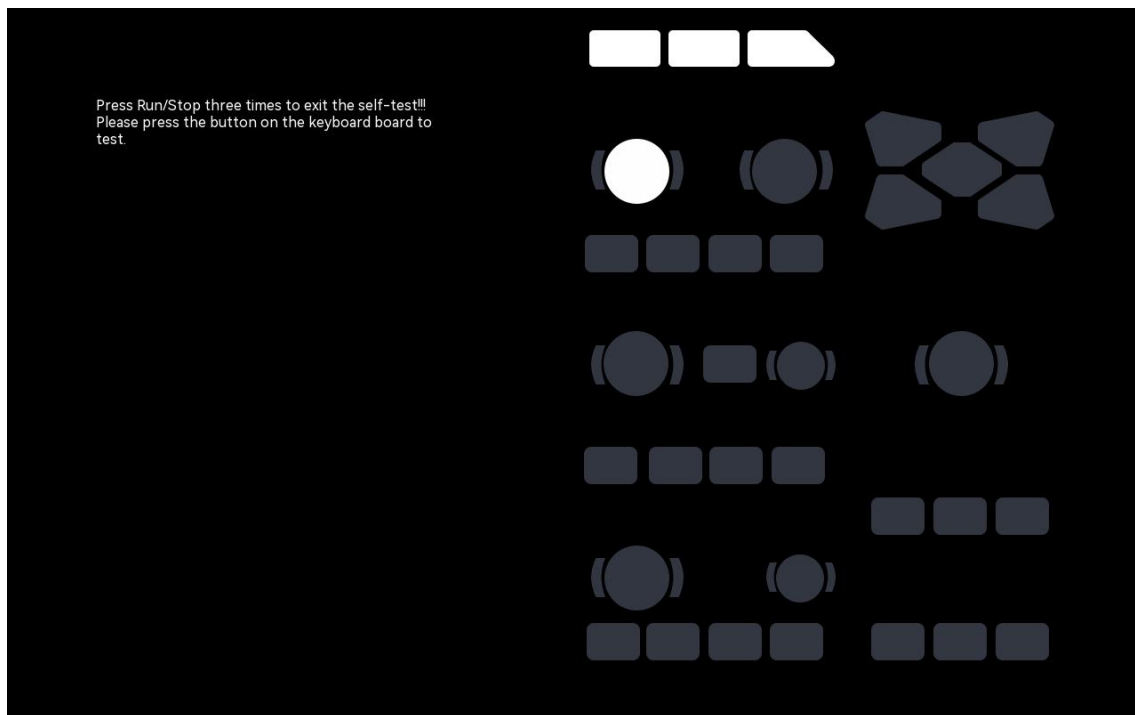

Rotary knob test: Rotate and press each rotary knob from up to down, left to right, observing the rotary whether the rotary knob indicator is lit on the display interface.

Key test: Rotate and press each key from up to down, left to right, observing the rotary whether the key indicator is lit in real time on the display interface.

When all rotary knobs and keys have been tested, press the "Run/Stop" keys three times to exit the keyboard test in accordance with the on-screen instructions.

(2) LED Detection

LED detection is mainly used to check whether the key indicator on the front of the oscilloscope can be lit or not, and whether the brightness is poor. When the LED test is pressed, the oscilloscope enters the interface is shown in the following figure.

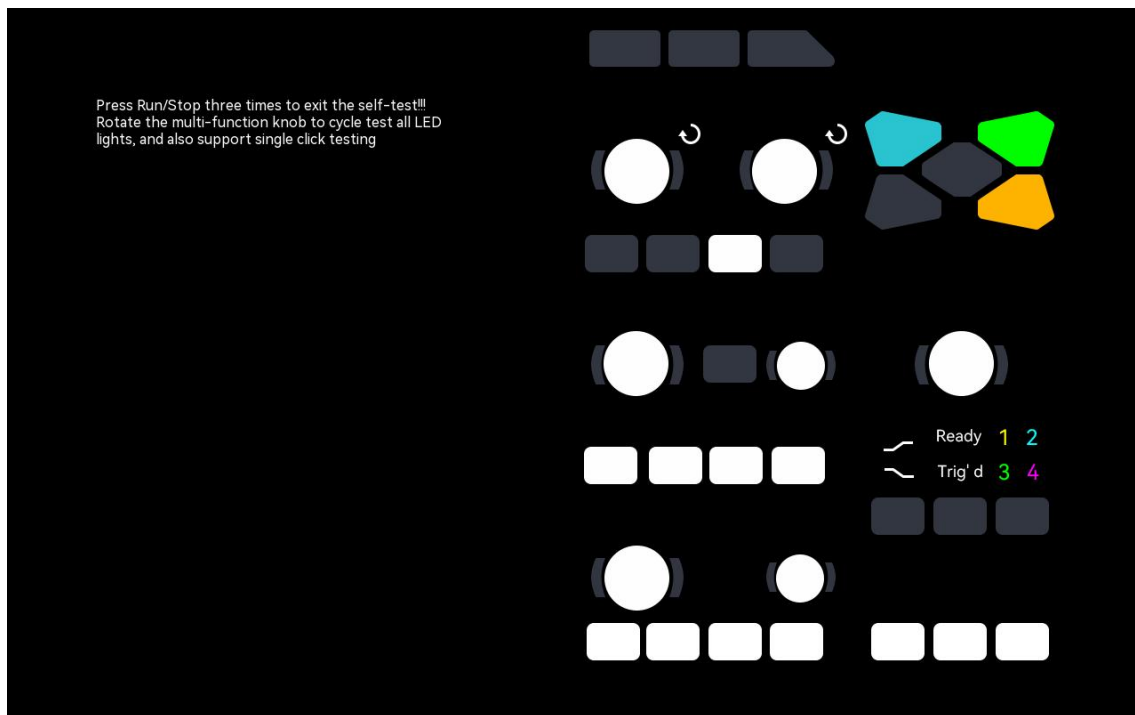

Rotary knob test: Enter the LED test, rotate the Multipurpose A rotary knob, the first LED on the front panel is light and the corresponding position of the key will be illuminated on the screen, continue rotating the Multipurpose A rotary knob to switch to the next LED. Using this method to detect all the key indicators one by one, observing whether all indicators on the front panel are illuminated.

Key test: Touch the white key on the screen, observing whether LED is lit in real time on the front panel.

When all rotary knobs and keys have been tested, press the Run/Stop keys three times to exit LED test in accordance with the on-screen instructions.

(3) Touch Screen Detection

Touch screen detection is mainly used to check whether the touch screen is invalid or not responding in time. Press the touch screen detection, the oscilloscope enters the interface is shown in the following figure.

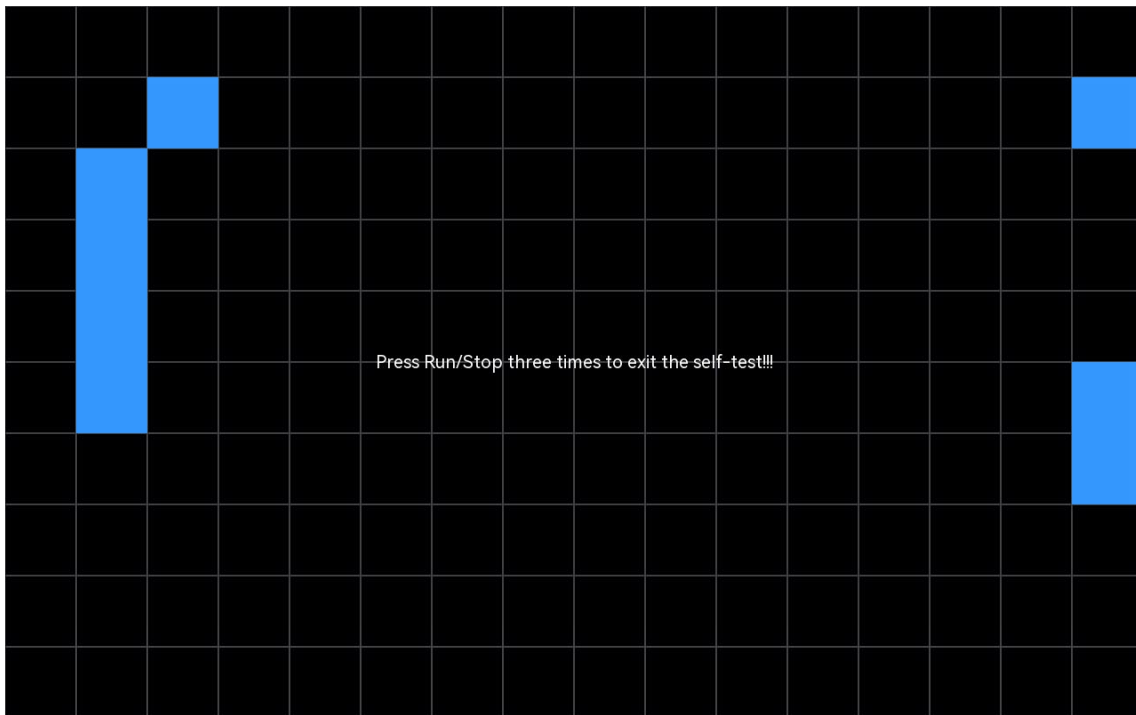

Touch each grid on the touch screen to observe if the grid turns blue.

When all rotary knobs and keys have been tested, press the Run/Stop keys three times to exit the touch screen test in accordance with the on-screen instructions.

(4) Screen Detection

Screen detection is used to check whether the oscilloscope screen has color offset, bad dots, or screen scratches. Press the screen detection, the oscilloscope enters the interface is shown in the following figure. The interface displays pure red.

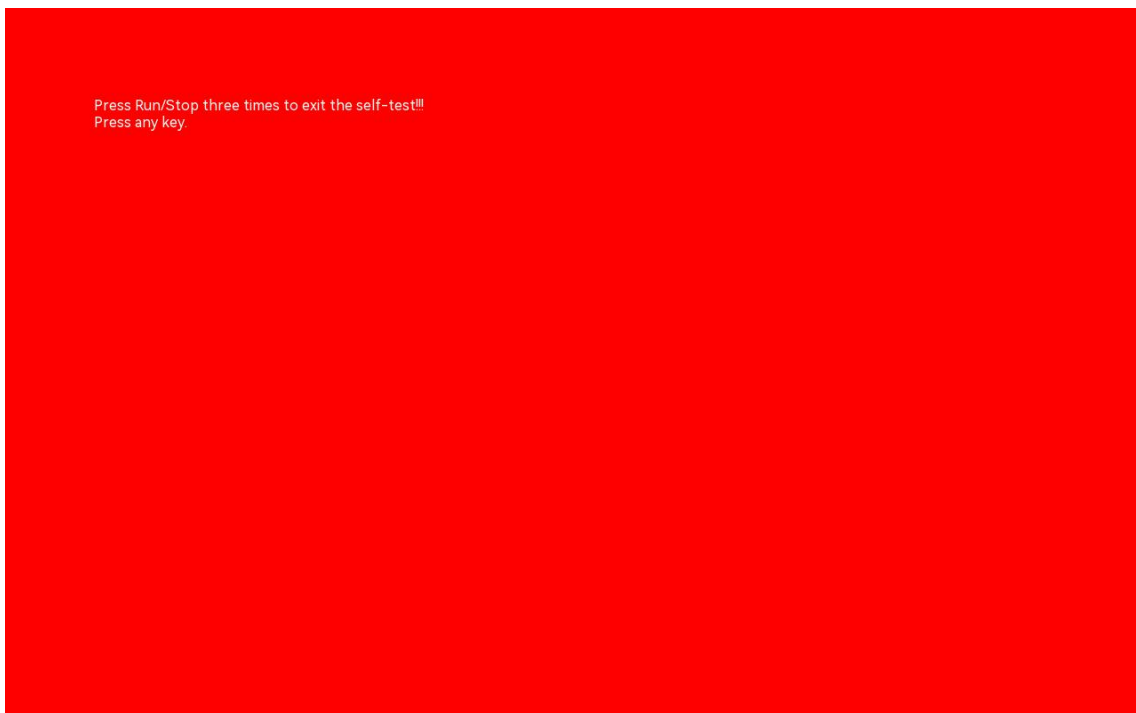

Press any key on the right panel to switch to the red, green, blue, black, and white according to the on-screen instruction. Observe the screen under the appropriate surface of each color to see if there are any serious problems such as color differences, stains or scratches.

When the color test has been tested, press the "Run/Stop" keys three times to exit the touch screen test in accordance with the on-screen instructions.

17.7. Auto-calibration

The auto-calibration function allows the oscilloscope to reach the optimum working condition for the most accurate measurement. The auto-calibration function is divided into analog channel calibration and Digital calibration. This function can be performed at any time, especially when the ambient temperature range varies within 5°C or more. Before performing the auto-calibration operation, please make sure that the oscilloscope has been turned on and running for more than 20 minutes.

- (1) Analog channel calibration: The calibration is only for analog channel and the calibration time is 3-5 min.
- (2) Digital calibration: The calibration is for digital channel and the calibration time is 3-5 min.

17.8. About Oscilloscope

Click on "About" in the auxiliary menu to check the oscilloscope information.

- Model: Product model
- Serial number, which is the unique identification
- Firmware version number
- Logic version number
- Hardware version number

17.9. Auto Setting

Click on the "Auto setting" in the auxiliary menu to enter the auto setting menu.

- (1) Channel Setting
 - In hold mode, the bandwidth limit, inverse phase, impedance, unit, probe multiplying ratio, label state remains the same, and coupling (ground), Vertical scale, offset and fine-tuning are reset to the default.
 - In auto mode, the impedance, unit, probe multiplier, and label state remain the same; other

settings are reset to the default.

(2) Acquisition Setting

- In current mode, all settings remain the same.
- In auto mode, the acquisition mode reset to the default; other settings remain the same.

(3) Trigger Source

- In current mode, the source, trigger coupling remains the same; other settings are reset to "edge trigger, auto, rising edge".
- In auto mode, all parameters are reset to the default.



(4) Activate Channel

- In current mode, the switch state remains the same when the channel is automatically set.
- In auto mode, only channels with a signal input will be activated.

18. Waveform Recording

The Waveform Record and Playback function allows you to playback recorded waveforms, enabling convenient analysis.

The Waveform Recording Menu can access using the following methods.

- Press the **Analyze** on the front panel to open the “Analyze” menu to click “Recording” to access the “Waveform Recording” menu.
- Click the Home icon  in the top right corner and select the waveform recording icon  to enter the waveform recording menu.
- If the waveform recording function is added into the toolbar, click waveform recording icon  in the toolbar in the top right corner to enter the waveform recording menu.

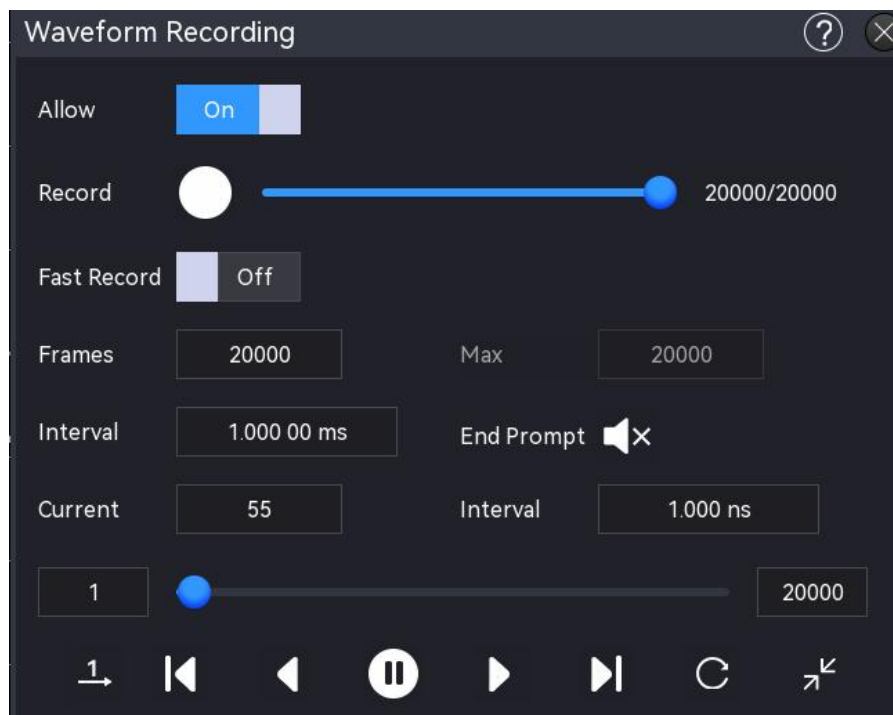



- (1) Turn on/off Recording



Click on the “Recording” switch to toggle the waveform recording to ON or OFF. Before using this function, refer to the [Recording Setting](#) section.

- (2) Recording

Click “Recording” to start recording.



- Click on the “Recording” key  to start recording. The recording icon  will change to , indicating that recording is in progress.
- The data displayed on the right side of the recording progress bar represents the current number of frames out of the total number of recorded frames. During the recording

process, the current recording information is shown on the screen in real time, with the current number of frames continuously updating.

- After recording, the recording icon  will change to , indicating that recording has stopped.
- During recording, click the icon  can pause the recording,



(3) Playback

Click on the “Playback” icon  to play back the recorded waveform. When playback starts, the icon  changes to , indicating that the waveform is being played back. For more details about playback, refer to the [Playback Setting](#) section.

During playback, “Current Frame” will change in real time. You can click pause key  to stop the playback.

18.1. Recording Setting

During waveform recording, the oscilloscope records the waveforms of all currently opened channels at specified intervals until the user manually stops the recording operation or the number of recorded frames reaches the set limit.

Before waveform recording, the following recording option parameters can be configured.

(1) Sequential Acquisition

Sequential acquisition, which allows for continuous and uninterrupted recording, improves the waveform capture rate. During sequential acquisition, the waveform is not displayed on the screen and can only be played back after the recording is completed. It can be set to on or off.

(2) Recording Frame

The number of recording frames refers to the total number of frames that can be recorded. After starting the recording operation, the oscilloscope will automatically stop recording when the number of recorded frames reaches the specified limit. Double-click on the “Recording Frame” input field to open the numeric keypad to set the recording frame. For details on the use of the numeric keypad, refer to the section of [5.8 Parameter Setting](#). Alternatively, select the parameter, use the [Multipurpose A](#) rotary knob to adjust the recording frame. The setting range can be set from 1 to the maximum frame.

(3) Maximum Frame

Maximum frames input box displays the highest number of frames that can be recorded.

Since the waveform memory size is fixed, a higher number of points per waveform frame results in fewer frames being recorded. Therefore, the maximum number of frames is directly related to the currently selected Memory Depth (see Memory Depth). The number of points per frame equals the current memory depth, which is calculated as \geq sampling rate \times horizontal time base \times the number of frames displayed horizontally on the screen. Consequently, the maximum value for waveform recording is also influenced by the "Sample Rate" and "Horizontal Time Base".

(4) Recording Interval

The recording interval is the time interval between frames during the recording process.

Double-click on the "Recording Interval" input field to open the numeric keypad to set the recording interval. For details on the use of the numeric keypad, refer to the section of [5.8 Parameter Setting](#). Alternatively, select the parameter, use the Multipurpose A rotary knob to adjust the recording interval. The setting range can be set from 0 s to 10 s

(5) End Recording

: The beeper sounds like a beep when recording ends.



: The beeper does not sound when recording ends.

18.2. Playback Setting

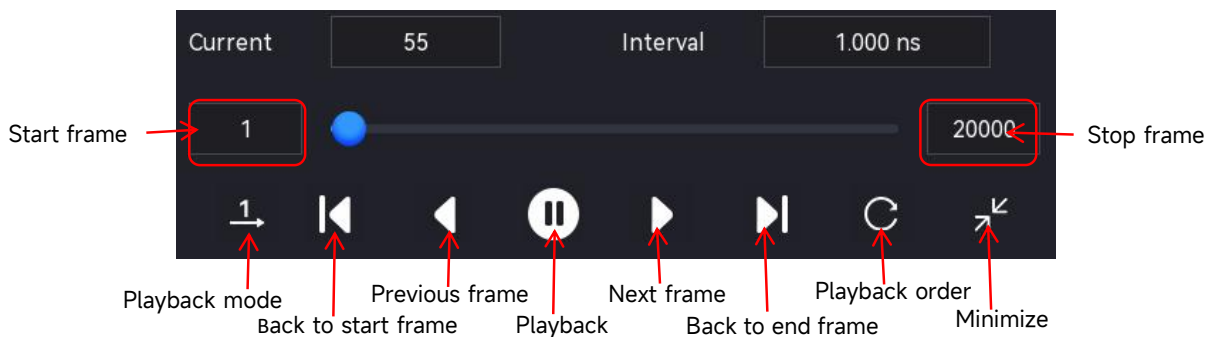
Before waveform recording, the following recording option parameters can be configured.





(1) Playback Mode

The playback mode is divided into two modes: single playback  and cycle playback . Click the icon in the bottom left corner of the screen to switch between modes.

: Playback starts from the start frame and ends at the end frame, stopping automatically.

: Playback starts from the start frame and ends at the end frame, repeating until manually stopped.



(2) Playback Order

The playback order consists of two types: sequential playback  and reverse playback . Click the icon in the bottom right corner of the screen to switch between them.

: Playback starts from the start frame to the end frame.

: Playback starts from the end frame to the start frame.

(3) Minimize

Minimize the playback window as needed. Click the minimize icon  to reduce the size of the playback window, simplifying the interface for a more intuitive and user-friendly experience; click the restore icon  to revert the window to its original size and exit the minimized view.

(4) Current Frame

When the playback is stop, double click on the “Current Frame” input field to open the numeric keypad to set the current frame. For details on the use of the numeric keypad, refer to the section of [5.8 Parameter Setting](#). Alternatively, select the parameter, use the Multipurpose A rotary knob to adjust the current frame. The maximum value that can be set is equal to the number of recorded frames.

(5) Playback Interval

The playback interval refers to the time interval between frames during playback. Double click on the “Playback Interval” input field to open the numeric keypad to set the playback interval. For details on the use of the numeric keypad, refer to the section of [5.8 Parameter Setting](#). Alternatively, select the parameter, use the Multipurpose A rotary knob to adjust the playback interval. The setting range can be set from 0 s to 10 s.

(6) Start Frame

The start frame is the frame from which playback begins. Double click on the “Start Frame” input field to open the numeric keypad to set the start frame. For details on the use of the numeric keypad, refer to the section of [5.8 Parameter Setting](#). Alternatively, select the parameter, use the Multipurpose A rotary knob to adjust the start frame. The default is 1. The maximum value that can be set is equal to the number of recorded frames.





(7) Stop Frame

The end frame is the frame at which playback stops automatically. Double click on the “Stop Frame” input field to open the numeric keypad to set the stop frame. For details on the use of the numeric keypad, refer to the section of [5.8 Parameter Setting](#). Alternatively, select the parameter, use the Multipurpose A rotary knob to adjust the stop frame. The default is the total number of frames in the recorded waveform.

19. Pass/Fail Test

In product design and production, monitoring signal changes and determining product qualification is often necessary. The standard pass/fail test function of this series of oscilloscopes effectively fulfills this need. Users can establish test rules based on known 'standard' waveforms, compare the signal under test with these standards, and display statistical information about the results. When the oscilloscope identifies a pass or fail, the user can choose to stop monitoring immediately, activate a buzzer alarm, and save the current screenshot.

The Pass/Fail Test menu can access using the following method.

- Press the **Analyze** on the front panel to open the “Analyze” menu to click “Pass/Fail” to access the “Pass/Fail” menu.
- Click the Home icon  in the top right corner and select the pass/fail test icon  to enter the pass/fail test menu.
- If the pass/fail test function is added into the toolbar, click pass/fail test icon  in the toolbar in the top right corner to enter the pass/fail test menu.
- If there has pass/fail test results pop-up box, click on the icon  to open the pass/fail test menu.

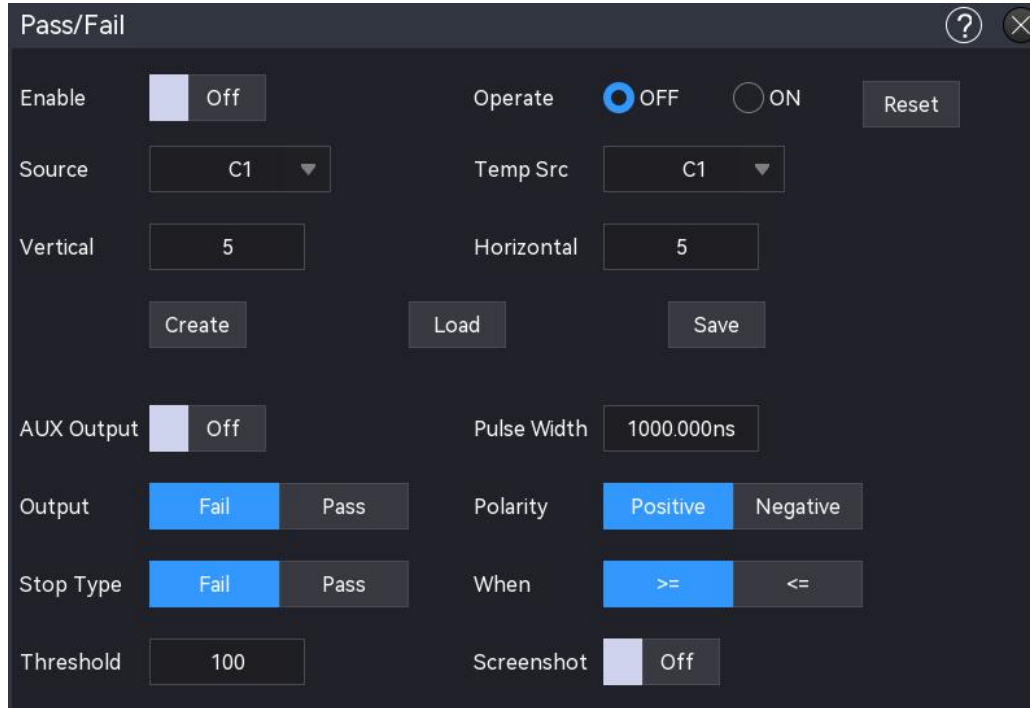

19.1. Turn on/off Pass/Fail Test

Click on the “Pass/Fail” switch to toggle the pass/fail test to ON or OFF.

19.2. Source

Click on the “Source” to select C1-C4.

19.3. Template Setting

(1) Template Source

Click on the “Template Source” to select the source for creating a template. The source can choose from C1-C4 and Ref.

(2) Adjusting Vertical

Double-click on the “Adjusting Vertical” input field, use the Multipurpose A rotary knob to adjust the vertical tolerance. The setting range can be set from 1 to 100.

(3) Adjusting Horizontal

Double-click on the “Adjusting Horizontal” input field, use the Multipurpose A rotary knob to adjust the horizontal tolerance. The setting range can be set from 1 to 50.

(4) Creating Test Rule

After setting the “Template Source”, “Adjusting Vertical”, and “Adjusting Horizontal”, click on the “Creating Rule” to define the test rule (the blue area are not covered on the screen).

(5) Load Test Rule

When the pass/fail test function is enabled, the user can load and recall test rule files stored in the instrument's internal memory or an external USB flash drive (if the USB flash drive is detected) and apply them to the current pass/fail test. Click “Load Rule” to access the file loading interface. Select the specified test rule file (*.tmp) from the “File Path” and apply it to the current pass/fail test.

(6) Save Test Rule

When the pass/fail test function is enabled, the user can save the current test rule range to the instrument's internal memory or an external USB flash drive in *.tmp format (if the USB flash drive is detected). Click “Save Rule” to open the file-saving interface. Enter the necessary information in the “File Name” and “Save Path” fields to save the test rule file to either internal or external memory. For details on the saving process, refer to the [Storage and Load](#) section.

19.4. Output Setting

(1) Aux Output

Click on the “Aux Output” switch to toggle the Aux Output function to ON or OFF.

- ON: When the Aux Output function is enabled, the AUX Output menu will automatically switch to “Pass/Fail”, indicating that during a pass or failure event, the Aux Output connector on the rear panel will output a pulse.
- When the Aux Output function is disabled, the AUX Output menu will automatically switch to “Trigger Output,” indicating that the Aux Output connector on the rear panel is not linked to the pass/fail test.

(2) Output Condition

Configure the signal output from the Aux Output connector. It can output two signals, pass or fail.

- Fail: When a failure event is detected, the Aux Output connector on the rear panel outputs a pulse.
- Pass: When a pass event is detected, the Aux Output connector on the rear panel outputs a pulse.

(3) Output Pulse Width

Set the pulse width for the pass/fail test. Double-click on the “Output Pulse Width” input field to open the numeric keypad to set the output pulse width. For details on the use of the numeric keypad, refer to the section of [5.8 Parameter Setting](#). Alternatively, select the parameter, use the Multipurpose A rotary knob to adjust the output pulse width. The setting range can be set from 200 ns to 1.5 s.

(4) Output Polarity

Click on the “Output Polarity” set the polarity of the output pulse to “Positive” or “Negative”.

19.5. Stop Setting

(1) Stop Type

Stop type refers to the condition under which the pass/fail test will cease operation upon detecting a specific signal. This can be set to Fail or Pass.

- Fail: When a “Fail” is detected, the count of failed frames increases by 1. The test will automatically stop once the number of failures reaches the predefined threshold.
- Pass: When a “Pass” is detected, the count of successes increases by 1. The test will stop once the number of successes reaches the specified threshold.

(2) Stop Condition

Click on the “Stop Condition” to configure the condition for ceasing the test. This can be set to \geq or \leq .

- \geq : The test will automatically stop when the number of frames of the stop type is greater than or equal to the specified condition.
- \leq : The test will automatically stop when the number of frames of the stop type is less than or equal to the specified condition.

(3) Condition Time

Double-click on the “Condition Time” input field to open the numeric keypad to set the condition time. For details on the use of the numeric keypad, refer to the section of [5.8 Parameter Setting](#). Alternatively, select the parameter, use the Multipurpose A rotary knob to adjust the condition time. The setting range can be set from 1 to 60000.

(4) Screenshot

Click on the “Screenshot” switch to toggle the screenshot function to ON or OFF.

- ON: Automatically captures and saves a screenshot to local or external USB storage when the pass test is stopped upon meeting the test conditions.
- OFF: No screenshot will be captured when the test is stopped.

19.6. Operation and Reset

(1) Operation

After configuring all the options mentioned above, click on the “Operation” to configure the pass/fail test.

- Start: Initiates the pass/fail test.
- Stop: Terminates the pass/fail test.

(2) Reset

During the pass/fail test, click on the “Reset” can clear the test results and restart the pass/fail test.

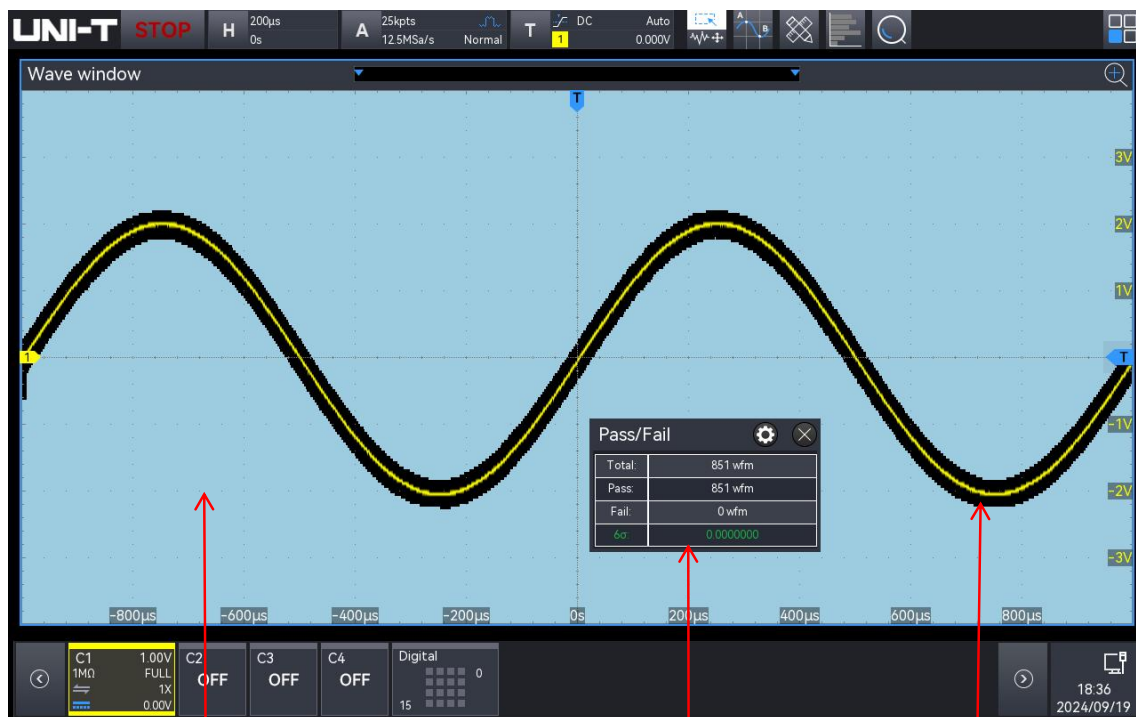

Blue area is mask area

Test result

Test the waveform

If it intersects with the masked area, the test will be considered a failure.

Note: Pass/fail tests can only be started or stopped when the pass/fail test function is enabled, and the test rule ranges are saved and loaded. Source channel changes and test rule adjustments are not permitted while the test is in progress.

19.7. Pass/Fail Test Result

When the “Pass/Fail” function is enabled, the test results window will be displayed on the screen.

Test results window: Displays fail frames, pass frames, total frames, and 6σ , as shown in the following figure.

Pass/Fail	
Total:	130398 wfm
Pass:	130398 wfm
Fail:	0 wfm
6σ:	0.0000000

- Total: Total tested frames
- Pass: Pass frames
- Fail: Fail frames
- 6σ: The ratio of fail frames to total tested frames

The 6σ criterion indicates that, out of one million operations, only 3.4 failures are expected.

20. System Upgrade

This series allows program updates via USB, providing convenience and flexibility.

There are two methods for updating using a USB flash drive:

Method 1: Turn on the oscilloscope, which will automatically detect the USB flash drive for updates.

Method 2: U Navigate to Home > Utility > Update to detect and select the update file on the USB flash drive.

To access the upgrade menu, enter the submenu "Upgrade" in the auxiliary menu. The oscilloscope supports three upgrade methods: local upgrade and online upgrade. The specific steps are as follows.

(1) Boot-up Upgrade

- ① Press **Utility** key to enter the auxiliary function menu, click on the "About" to check the system information: model name, software and hardware version.
- ② Download the update file from UNI-T official website or ask UNI-T distributor to provide the upgrade file. The upgrade file is the same as the model and hardware version of the instrument, the software version is higher than the version of the instrument. Save the upgrade file in the root directory of the USB.
- ③ The instrument is in shut down state. Insert USB and boot up the instrument, press the power softkey, the instrument will automatically detect and update.
- ④ The upgrade process takes 5 minutes. After the upgrade is finished, shut down the instrument and plug out USB.
- ⑤ Reboot the instrument to check that the system information is the same as the version supplied. If it is the same, the update is successful.

(2) Local Upgrade

Save the upgrade file to USB and connect USB to the instrument. The upgrade can be processed when the instrument detects USB.

① Upgrade File

Click on the "Upgrade File" in the root directory of USB or click on the "Browse" to enter the file browser to select the upgrade file, and then click on the "Enter" to process the upgrade setting.

② Upgrade

Click on the "Upgrade" to open the upgrade confirmation box to choose whether "Enter" or "Cancel" the upgrade.

- Enter: Process the upgrade according to the currently selected upgrade file.

- Cancel: Cancel the current upgrade or click the icon  on the right to cancel.

③ Refresh

Click on the "Refresh" to update and display the upgrade file.

(3) Online Upgrade

First, make sure that the LAN port on the rear panel of the instrument is connected to the network (if there is any restriction on the privileges, please open the network privileges).

Click on the "Online upgrade" to open the upgrade confirmation box to choose whether "Enter" or "Cancel" the upgrade.

- Enter: Process the upgrade according to the currently selected upgrade file.

- Cancel: Cancel the current upgrade or click the icon  on the right to cancel.

Note: Please ensure that the power is not shut down during the entire upgrade process, it is to avoid failure to reboot due to incomplete system upgrade content.

21. Bode Plot

The Bode plot function provides a frequency response curve for the Device Under Test (DUT). During the scan, the oscilloscope configures the function/arbitrary waveform generator to output a signal to the DUT. It then compares the DUT's input and output signals, measuring the gain (G) and phase (P) at each frequency, which are plotted on the frequency response Bode plot. When the loop response analysis is complete, you can move the cursor on the chart to view the measured gain and phase values at various frequency points. You can also adjust the scale and offset settings for the amplitude and phase plots.

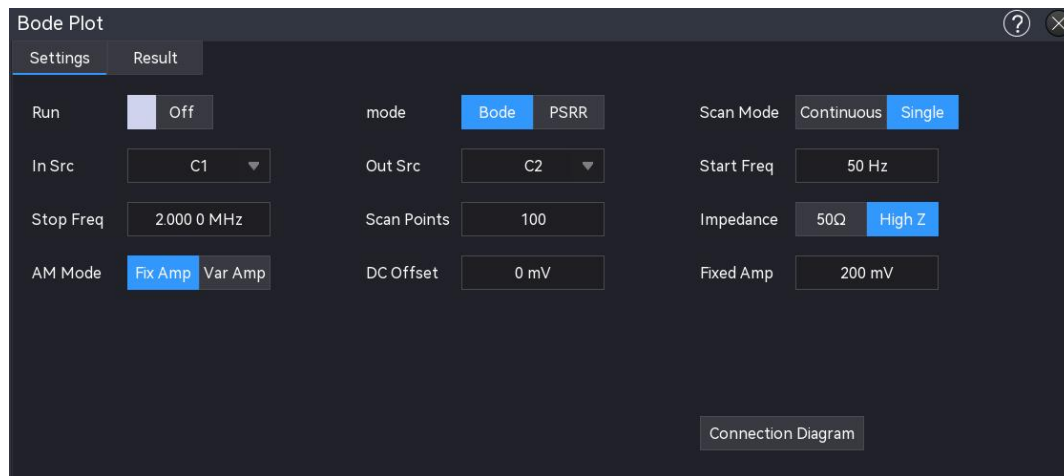

21.1. Sweep Configuration

(1) Wiring Diagram

Before using the Bode plot (Power Supply Rejection Ratio) function, you need to set up the loop connections as shown in the diagram below. You can open the wiring instructions to view the circuit connection diagram for using the Bode plot (Power Supply Rejection Ratio) function in the pop-up window.

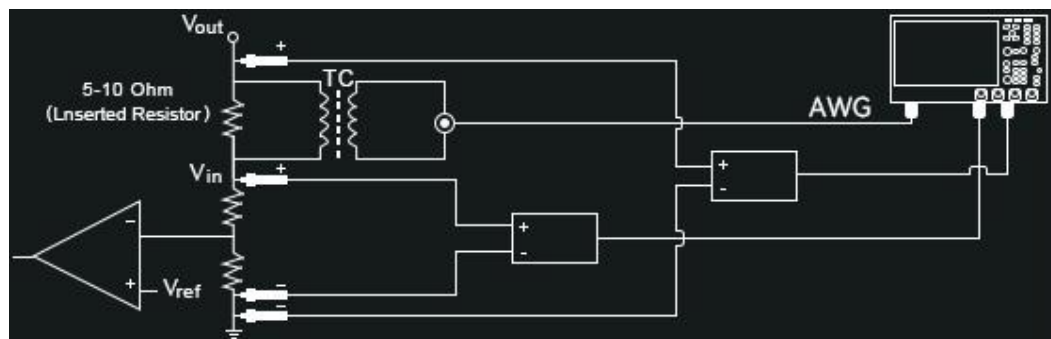

(2) Operation

Click on the "Operation" to set the Bode plot to on or off.

(3) Mode

Click on the "Mode" to set the operating mode to Bode plot or power supply rejection ratio (PSRR).

- Bode Plot: Conducts a Bode plot scan, displaying both gain and phase curves simultaneously.
- Power Supply Rejection Ratio (PSRR): Performs a PSRR scan, displaying only the gain curve. The PSRR test determines how well a voltage regulator suppresses ripple noise across different frequency ranges. This analysis uses a waveform generator from the oscilloscope to provide a signal with varying frequencies, introducing ripple into the DC voltage supplied to the regulator. The AC RMS ratio of input to output is measured and plotted against the frequency range. Multiple methods can be used to measure PSRR. Due to higher background noise and lower sensitivity compared to a network analyzer, the oscilloscope PSRR measurement typically does not exceed -60 dB. However, PSRR testing with an oscilloscope is generally acceptable for a quick assessment of the overall PSRR behavior of the power supply under test.

(4) Sweep Mode

Click on the "Sweep Mode" menu to select the scanning mode: single scan and continuous scan.

- Single sweep: The sweep proceeds from the start frequency to the end frequency and then stops automatically.
- Continuous sweep: The sweep continuously cycles from the start frequency to the end frequency without automatically stopping.

(5) Sweep Settings

Set the sweep setting: Start frequency, stop frequency, sweep points, amplitude mode, amplitude setting, DC offset, and source impedance.

- a. Start frequency: Set the start frequency for the scan. Range: 50 Hz - 25 MHz.
- b. Stop frequency: Set the stop frequency for the scan. Range: 60 Hz - 25 MHz.
- c. Sweep points: Set the number of scan points; a higher number provides better scan resolution. Range: 1 - 1000.
- d. Amplitude mode: Set the amplitude of the scan signal, allowing for either fixed amplitude or variable amplitude.
 - Fixed amplitude: When the amplitude mode is set to fixed amplitude, the signal amplitude remains at a constant value. The adjustable range is 10 mV to 3 V (for a 50 Ω impedance) and 20 mV - 6 V (for a high-impedance setting).
 - Variable amplitude: When the amplitude mode is set to variable amplitude, the input

signal can be set to different amplitudes at various frequency stages. The adjustable range is 10 mV - 3 V (for a 50 Ω impedance) and 20 mV - 6 V (for a high-impedance setting).

- e. DC Offset: Set the offset of the sweeping signal. The adjustable range is -1 V to 1 V.
- f. Source impedance: Set the source load to 50 Ω or high impedance.

(6) Channel Settings

Set the input and output signal channels for the device under test.

a. Input Source

Click on the "Input Source" menu to select the input signal channel for the Bode plot (Power Supply Rejection Ratio). C1-C4 can be set.

b. Output Source

Click on the "Output Source" menu to select the output signal channel for the Bode plot (PSRR). C1-C4 can be set.

Note: The input source and output source cannot be the same channel.

21.2. Display Setting

(1) Bode Plot Display Settings

Set the display parameters: Automatic settings, gain range, gain offset, phase range, phase offset, start frequency, stop frequency, gain display, and phase display.

- a. Automatic settings: Based on the amplitude and phase curves of the output signal, the oscilloscope automatically sets parameters such as gain range, gain offset, phase range, phase offset, start frequency, and stop frequency.
- b. Gain display: Set whether to display gain data and related information in the waveform window. The gain display can be toggled on or off.
- c. Phase display: Set whether to display phase data and related information in the waveform window. The phase display can be toggled on or off.
- d. Gain range: Set the gain range displayed in the waveform window. Range: 1 dB - 500 dB.
- e. Gain offset: Set the gain offset displayed in the waveform window. Range: -250 dB to 250 dB.
- f. Phase range: Set the phase range displayed in the waveform window. Range: 1° - 180°.
- g. Phase offset: Set the phase offset displayed in the waveform window. Range: -180° to 180°.
- h. Start frequency: Set the start frequency displayed on the horizontal axis of the waveform window. Range: 50 Hz - 25 MHz.
- i. Stop frequency: Set the stop frequency displayed on the horizontal axis of the waveform

window. Range: 60 Hz - 50 MHz.

21.3. Result Analysis and Export

(1) Result Analysis

The sweeping results are shown in the figure below. Using the data list and cursor measurement functions, you can conduct a detailed analysis of the Bode plot curves. The data list provides information for each scan point, and the cursor line allows for flexible measurement of changes at various positions on the curve.



1. Gain scale: Displays the gain based on the configured gain range and offset.
2. GM (Gain Margin): The difference between the gain measurement at the frequency point where the gain is 0 dB and the phase is 0°, calculated as $GM = 0 \text{ dB} - \text{Gain Measurement}$.
3. PM (Phase Margin): The difference between the phase measurement at the frequency point corresponding to 0 dB gain and 0°.
4. Cursor: A movable cursor that measures the gain, phase, and frequency values at the intersection points of the gain result curve and phase result curve.
5. Two Cursor Lines: Displays the gain values, phase values, and frequency values at the intersection points with the gain and phase curves.
6. Swept phase result curve
7. Swept gain result curve
8. Frequency scale: Displays the configured start frequency and stop frequency for the sweep.
9. Phase scale: Displays the phase based on the configured phase range and offset.

(2) Table

The table provides information for each sweep point. By checking the "Table" option, the sweep point information will be displayed in tabular form. The displayed content includes the sweep point, frequency, amplitude, gain, and phase.



21.4. Result Analysis and Load

(1) Save Results Table

After opening the result table, click the "Save event table" to pop up the export setting menu, the data can be saved in *.csv to internal storage or external USB disk drive (when a USB is detected). For the setting steps, refer to the section of [Save and Load](#).

(2) Load Results Table

When Bode plot data is saved in internal storage or on an external USB drive (only when the USB flash drive is detected), the table can be loaded into the oscilloscope and display the corresponding Bode plot graphic. Check the "Table" option, click "Load," and a loading dialog box will appear. Double-click the "File" input box to open the file browser interface. In the file browser interface, select the Bode plot file you need to load and click "Load" to load the Bode plot data.

22. Web Access

22.1. Access Local Area Network

The computer and spectrum analyzer should share the same LAN. Check the local IP address through the UTILITY menu of spectrum analyzer, and then the browser accesses the spectrum analyzer using http://ip:9000 port.

Example:

- Computer IP: 192.168.42.3
- Oscilloscope IP: 192.168.42.12
- PC browser using 192.168.42.12 to access the oscilloscope can check the basic information, as shown in the following figure.

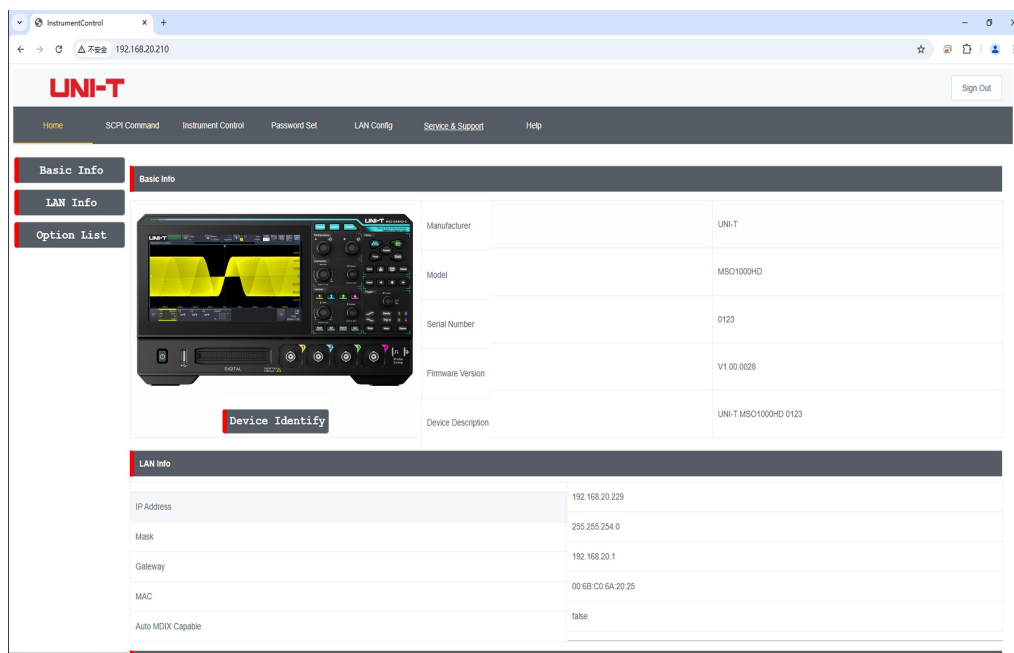

When you click on the "SCPI Command," "Instrument Control," "Network Settings," or "Password Settings" tab, you will need to log in. Please refer to the "Login Web" section for detailed login instructions.

22.2. Login Web

Many operations require logging into the web system. The login credentials are as follows:

- **Username:** admin
- **Password:** The initial password is the serial number of the oscilloscope after Base64 encoding. Once you have successfully logged in, you can set up a customized password according to your needs. After creating the customized password, you can use it for future logins.

22.3. Access Outer Network

To access the oscilloscope from an external network, where the access terminal and the oscilloscope are not on the same network segment, follow these procedures:

- Ensure the network cable is plugged into the oscilloscope and that internet access is available.
- Turn on the frp proxy service on the server.
- Configure the frp proxy service and IP port of the oscilloscope.
- Accessing the port http://IP:web_port via browser, which is to visit the oscilloscope, the access interface is same as above mentioned

Note: This instrument uses a way of frp (Fast Reverse Proxy) intranet penetration to access the outer network. The frp version is 0.34.0. The instrument carries an FRP-0.34.0 client port, required with a server to run, with frp sever opened. The client connects to the FRP server port 7000, so the server configuration must include “bind_port = 7000”.

22.4. Home Page

The home page of the web system displays the basic information of the currently connected instruments, along with network information and an option list.

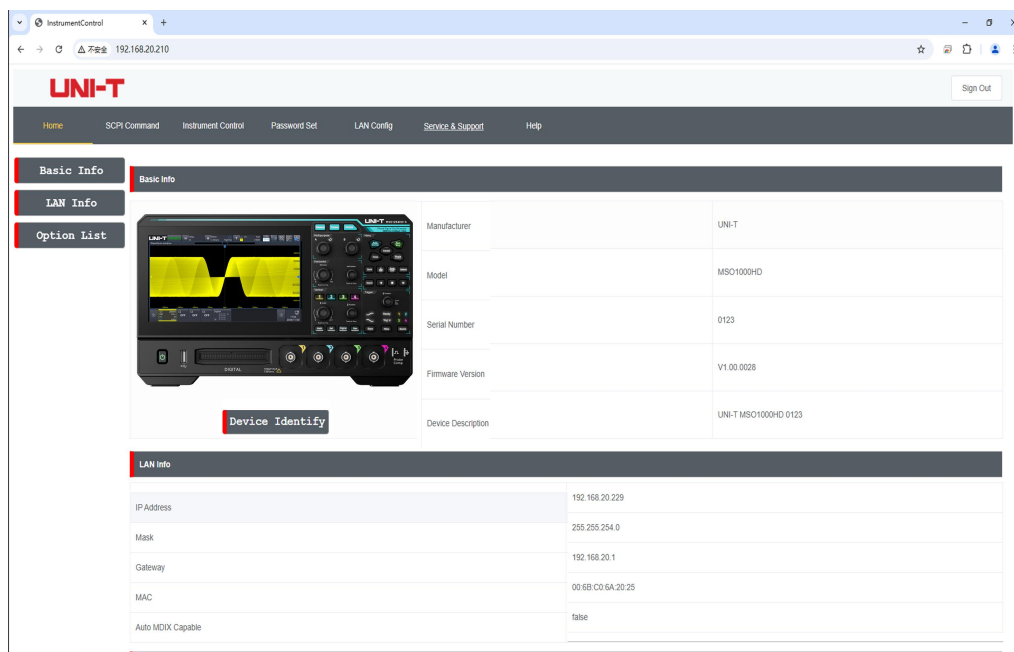

The screenshot shows the UNI-T web system interface. The browser address bar displays 'InstrumentControl' and the URL '192.168.20.210'. The page features a navigation menu with options: Home, SCPI Command, Instrument Control, Password Set, LAN Config, Service & Support, and Help. A 'Sign Out' button is located in the top right corner. The main content area is divided into sections: 'Basic Info', 'LAN Info', and 'Option List'. The 'Basic Info' section includes a 'Device Identify' button and a table of device details. The 'LAN Info' section displays network configuration parameters.

Basic Info	
Manufacturer	UNI-T
Model	MSO1000HD
Serial Number	0123
Firmware Version	V1.00.0028
Device Description	UNI-T MSO1000HD 0123

LAN Info	
IP Address	192.168.20.229
Mask	255.255.254.0
Gateway	192.168.20.1
MAC	00:6B:C0:6A:20:25
Auto MDIX Capable	false

22.5. SCPI

On the Web System SCPI Command page, the user can send SCPI commands to the currently connected oscilloscope.

- **Input command:** Click “Input Command” to expand the drop-down list of SCPI commands. This list displays all the SCPI commands supported by the oscilloscope. Select the desired command and edit the parameters (channel, etc.) as needed. Click “Execute” to send the SCPI command.
- **SCPI output:** Displays the results of the SCPI commands. When a command is executed, the SCPI output box will show detailed results of both the command sent and the response received.
- **Open SCPI programming manual:** Click “SCPI” to access the SCPI programming manual for this oscilloscope.
- **Clear:** Click to clear the contents of the SCPI output box.

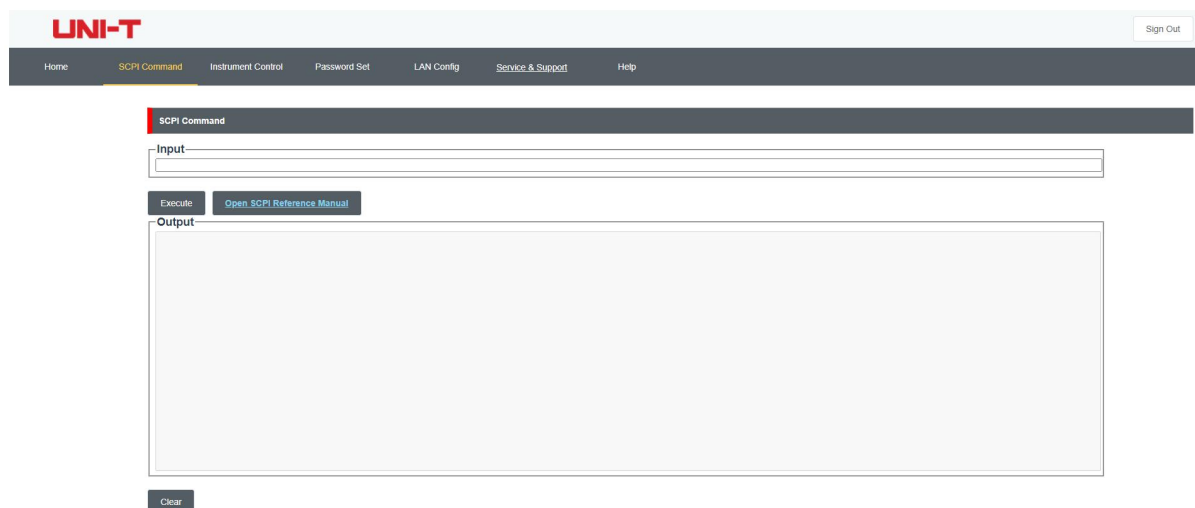

22.6. Instrument Control

On the Web System Instrument Control page, the user can operate the functions of the oscilloscope using a touch screen or a mouse. All operations can be completed using the mouse within the webpage, such as:



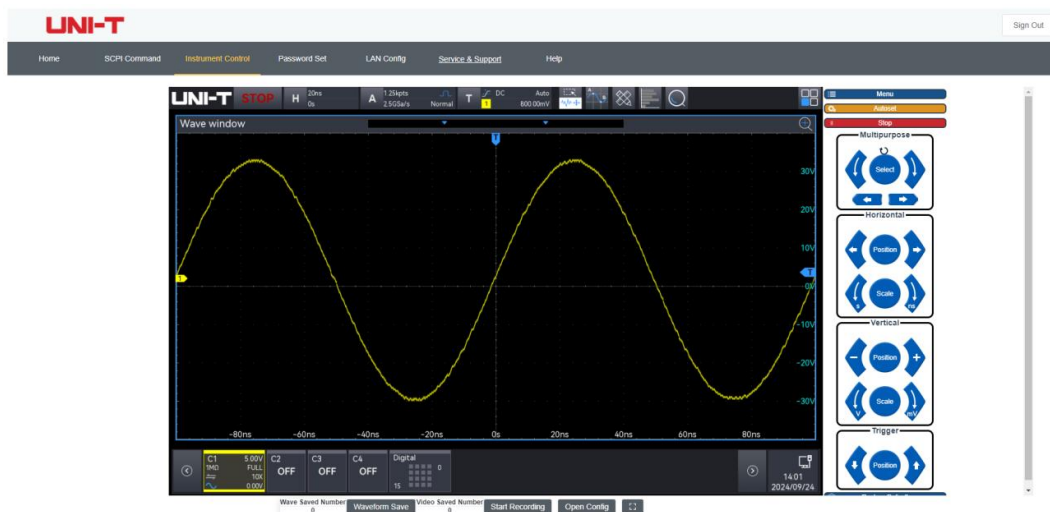









- **Waveform manipulation:** Click and drag the waveform to move it vertically and horizontally. You can also adjust the trigger level position and reposition pop-up boxes by dragging.
- **Webpage:** On the webpage, you can use the mouse wheel to interact with the knobs or click them to adjust the waveform's horizontal and vertical positions, modify the time base scale, change the volts-per-division scale, perform coarse and fine tuning, and set the trigger level position, among other functions.
- **Menu interactions:** Mouse clicks on the screen can open and close drop-down menus, pop-up boxes, and switch between menu options.
- **Input keyboard:** Double-click on the screen to open the numeric keypad, alphabetical keypad, or other input options.





(1) Key Area

- Menu: Click the "Menu" key to open the auxiliary menu dialog box.
- Auto: Click the "Auto" key to perform the Autoset operation.
- Run/Stop: Click the "Run/Stop" key to change the oscilloscope's operating state.
- Reset: Click to restore the settings to factory defaults.

(2) Rotary Knob

- Multi-function Knob: Supports multi-functional operations through a dialog box. Clicking the buttons  ,  on either side of the knob to modify the numeric values. Clicking the buttons  ,  at the bottom switches the numeric digits. When certain input fields have a default reset option available, clicking the knob can restore them to their default settings, such as the decoder line position.
- Horizontal-Position: Clicking the buttons  ,  on either side of the knob or scrolling the rotary knob moves the waveform's horizontal position. Clicking the knob sets the horizontal position to center.
- Horizontal-Scale: Clicking the buttons  ,  on either side of the knob or scrolling the rotary knob moves the waveform's time base. Clicking the knob switch the fine tuning or coarse tuning.
- Vertical-Position: Clicking the buttons  ,  on either side of the knob or scrolling the rotary knob moves the waveform's vertical position. Clicking the knob switches between fine tuning and coarse tuning.
- Vertical-Scale: Clicking the buttons  ,  on either side of the knob or scrolling the rotary knob moves the waveform's volts/div scale. Clicking the knob switches between fine

tuning and coarse tuning.

- Trigger-Position: Clicking the buttons  ,  on either side of the knob or scrolling the rotary knob moves the waveform's trigger position. Clicking the knob sets the level to center.

(3) Configuration

Click on “Configuration” to open the save configuration window, where you can save trigger or waveform settings, set up video recording, and print screenshots.

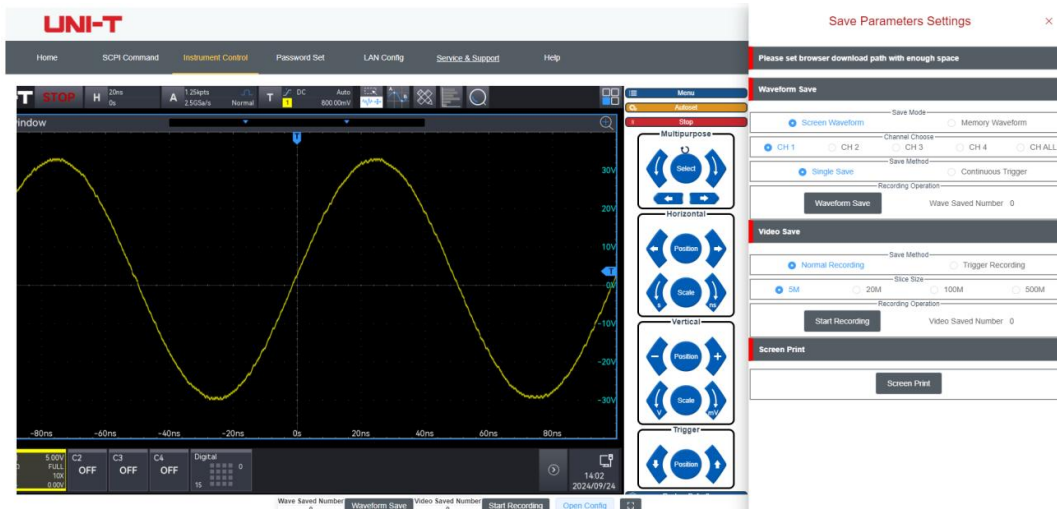

① Save Waveform

Save the screen waveform in .dat and .csv formats. Once the saving is complete, download the files to a local PC. The downloaded .dat and .csv files are compatible with waveform analysis software on the host computer.

- Save mode: Set the save mode for waveform saving and video recording. Screen waveform and deep memory waveform can be set.
 - Screen waveform: Saves or records only the waveforms displayed in the oscilloscope screen area, with the saved file format being .dat.
 - Deep memory waveform: Saves or records all data based on the oscilloscope's set storage depth, which includes waveforms outside the visible screen. The saved file format is .csv.
- Channel selection: Select the channel for waveform saving. The available options are CH1, CH2, CH3, CH4, and ALL (only for screen waveforms). If the channel is not enabled, its data cannot be saved.
- Save method: Select the method to single save or continuous trigger for saving waveforms. Both methods can be selected.
 - Single save: Saves only the .dat data from a single trigger of the selected channel.

- Continuous trigger: Builds upon the single save by performing a Single operation and then saving the waveform data after detecting a STOP state. This process continues in a loop.
- d. Recording operation: Click on the "Save Waveform" key to start saving the screen ".dat" file. During the saving process, click "Stop Saving" to cease the operation, which will automatically download the ".dat" file to local storage.
Note: During deep storage saving, if you click "Stop Saving," the incomplete file will not be saved or downloaded.
- e. Number of saved files: Displays the number of files that have been saved and downloaded to local storage during this operation.

② Video Recording

Clicking "Screen Recording" allows you to record the current instrument interface on the web. During the recording, clicking "Stop Recording" will end the recording process. Once the recording stops, a video in .mp4 format will be generated, displaying the recording duration. After completion, the video will be automatically downloaded to local storage.

- a. Save mode: Select the mode to normal recording or trigger recording for recording the video.
 - Normal recording: This records the operations on the oscilloscope screen, directly generating a video in .mp4 format without changing the oscilloscope's state.
 - Trigger recording: This captures the current triggered screen, saves it as an image, and downloads it to local storage while adding it to the video data. It automatically sends the :KEY:Single command and checks for the STOP status; if the status is true, the current triggered screen is saved as an image and added to the video data. This process repeats until the amount of video data is greater than or equal to the specified segment size, after which it saves and continues accumulating the next segment of video data.
- b. Segment size: Choose the size of the recorded video. When the recorded data exceeds the specified size, the recording will automatically stop and download the video, after which it will automatically start recording the next video. The video size can be set to 5M, 20M, 100M, or 500M.
- c. Recording operation: Click the "Start Recording" button to begin saving video data according to the selected save method. During the recording, clicking "Stop Recording" will stop the recording and directly save the current video data from memory as a video file, which will be downloaded to local storage.
- d. Number of files saved: Displays the number of files that have been saved and

downloaded to local storage during the current operation.

③ PrintScr

Click on the "PrintScr" key to save the oscilloscope screen as a .png file. Click "Download Image" to download the image to local storage.

22.7. Network Setting

Network configuration allows users to set the oscilloscope's network details, including LAN settings and external network proxy configurations.

a. Oscilloscope Network Information Settings

Item	Value
IP	192.168.20.220
Mask	255.255.254.0
Gateway	192.168.20.1

Click the “Modify Oscilloscope Configuration” key to set the oscilloscope's local network information. The network settings include the IP address acquisition method (DHCP/STATIC), local IP address, subnet mask, and gateway settings.

- DHCP: If you select DHCP as the IP setting method, there is no need to enter the IP address, subnet mask, or gateway information. Simply click “Confirm,” and the oscilloscope will automatically obtain the IP address.
- STATIC: If you choose STATIC as the IP setting method, you must enter the correct IP address, subnet mask, and gateway information before clicking “Confirm”.

After modifying the oscilloscope's network configuration, you can access it using the new IP address information (provided the configuration is correct).

b. FRP Agent Network Information Settings

Item	Value
Frp IP	121.37.220.55
Web Port	9005
Pic Port	9007
Ctrl Port	9006

- Modify FRP Proxy Configuration: This option allows you to set the current oscilloscope's

FRP proxy information, including the FRP proxy server IP address, port, picture port, and control port.

- **Get FRP Used Ports:** This feature displays the ports currently in use by the specified proxy IP. When configuring proxy ports, ensure that you avoid using these occupied ports.

Frp Port Usage ×

TCP	9000	online
TCP	9001	online
TCP	9002	online
TCP	9005	online
TCP	9006	online
TCP	9007	online
TCP	9605	online

Once you have finished inputting the necessary information, click “OK.” You can continue to access the oscilloscope using the modified FRP proxy address information (assuming the configuration is correct).

Note: If each oscilloscope is connected to the same FRP server, the web_port, pic_port, and ctrl_port for each oscilloscope must be unique. Otherwise, the FRP proxy will fail, resulting in inaccessible connections.

After modifying the FRP proxy settings, access via LAN using ip:9000 may not work. To restore normal LAN access, press the **Default** key on the oscilloscope panel to reset the configuration information. After resetting, you will be able to access the oscilloscope using port 9000 again.

22.8. Password Setting

The password setting allows users to configure their login credentials. After logging into the web system for the first time, users can create a customized password based on their serial number encoded in Base64. Once the password is set, users can log in with the new password in subsequent sessions.

If you forget your password and need to reset it, press the **Default** key on the oscilloscope panel.

Note: After resetting the oscilloscope to its default settings, you will need to log in to the web system again using the serial number encoded in Base64.

Item	Value
Old Password	<input type="text"/>
New Password	<input type="text"/>
Confirm New Password	<input type="text"/>

22.9. Help

Click on the “Help” page to enter the Web usage help page, which provides basic instructions for each tab of the oscilloscope Web access.

22.10. Service and Support





Click on the “Service and Support” page to be directed to the UNI-T official website of <https://www.uni-trend.com/>.

23. Mathematical Operation

- [Basic Operation](#)
- [Digital Filter](#)
- [Advanced Operation](#)

MSO1000HD series high-resolution signal oscilloscope carries a variety of mathematical operations, including Math, digital filter and advanced operation.

The “Math” menu can be entered using the following steps.

- Press the **Math** key on the front panel to enter the math setting menu.
- Click the Home icon  in the top right corner and select the save icon  to enter the math setting menu.
- If the math function is added into the toolbar, click the counter icon  in the toolbar in the top right corner to enter the math setting menu.
- When M1-M4 is opened, click on the M1-M4 label at the bottom of screen, or click the icon  in the top right corner to enter the math setting menu.

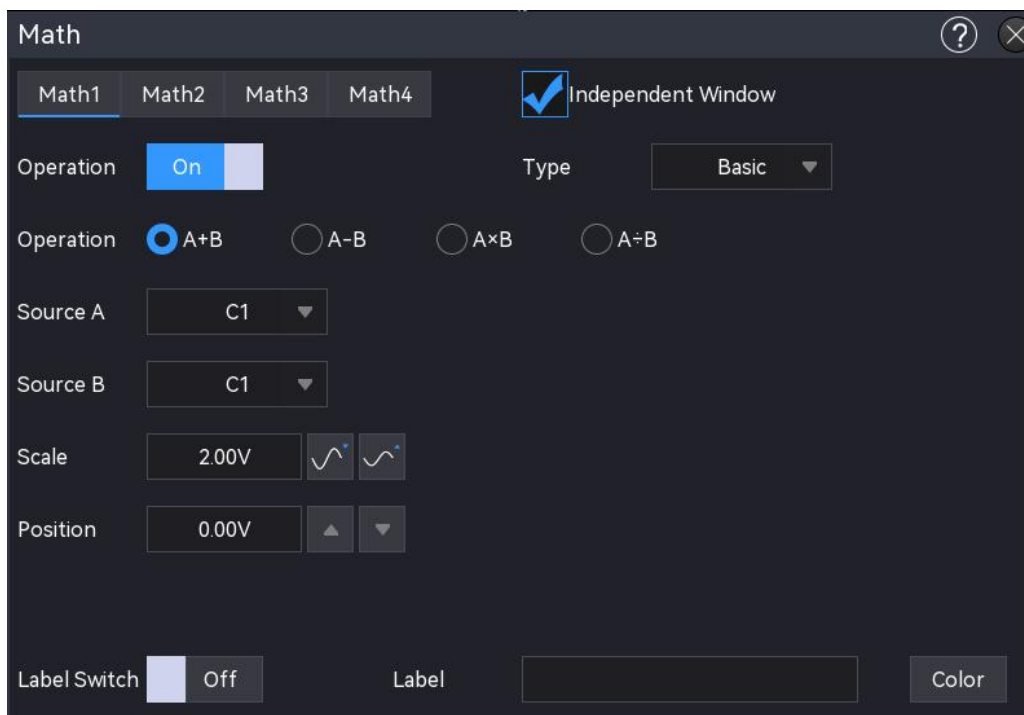

This oscilloscope supports 4 mathematical operations: Math1, Math2, Math3, and Math4, and supports the result of Math wave displayed in a separate window, and the label and channel color can be set. In the Math menu, press M1-M4 to select and set. In this chapter, Math1 is used as an



example to introduce the math function.

(1) Operation

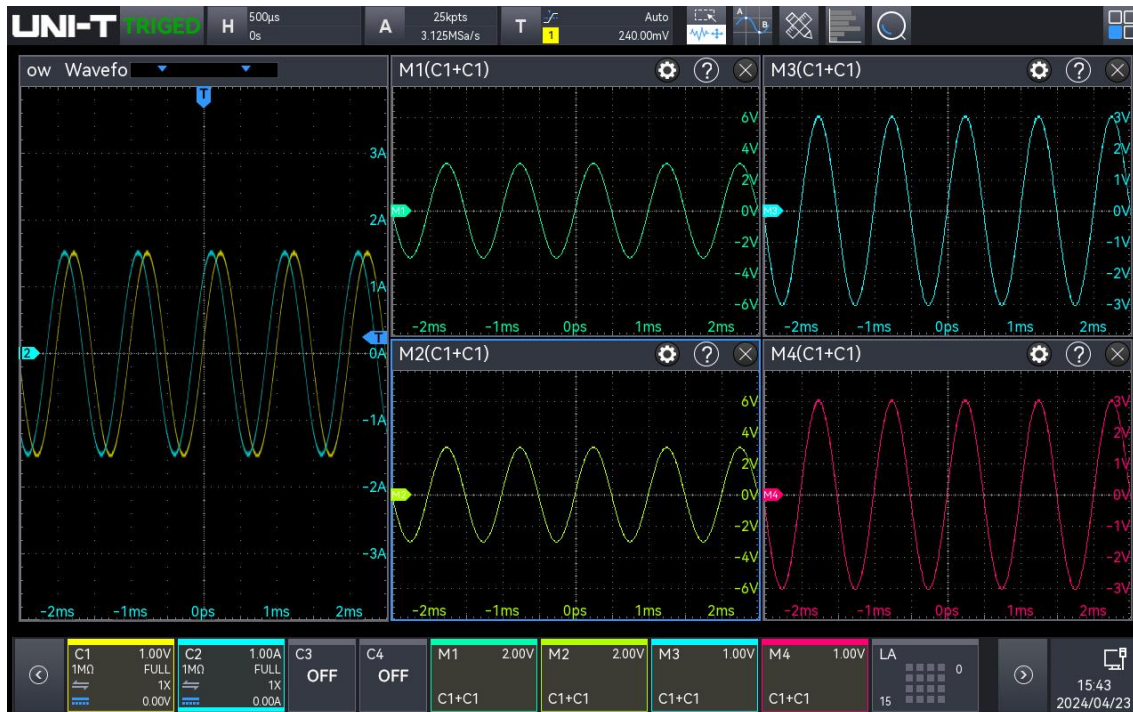
In the Math menu, click on the “Operation” to switch on/off the operation result of Math wave. The default is “OFF”. Once M1-M4 is set to “ON”, the operation result of Math wave will be displayed on the screen, as shown in the following figure.



(2) Separate Window

The operation result of Math wave can be displayed in a separate window. Click on , 4 Math waves and the channel wave are displayed in a separate window. Click on , 4 Math waves and the channel wave are displayed in the same window.

When the operation result of Math wave is displayed in a separate window, drag the label bar above the window to change the window position, or click on the icon “x” on top right corner to close the window.

(3) Label

Set the wave label for the Math wave operation result display window, see the section of [6.10 Label](#) for setting.

(4) Channel Color

Set the color for Math channel and Ref waveform and its label.

- Source: Click on the “Source” to select the source to set the color, the source can select M1, M2, M3, M4, R1, R2, R3, or R4.
- Color: Tap the color plate and drag to select the color.

23.1. Basic Operation

In the Math menu, click on the “Math type” to select “Basic operation” to enter the setting.

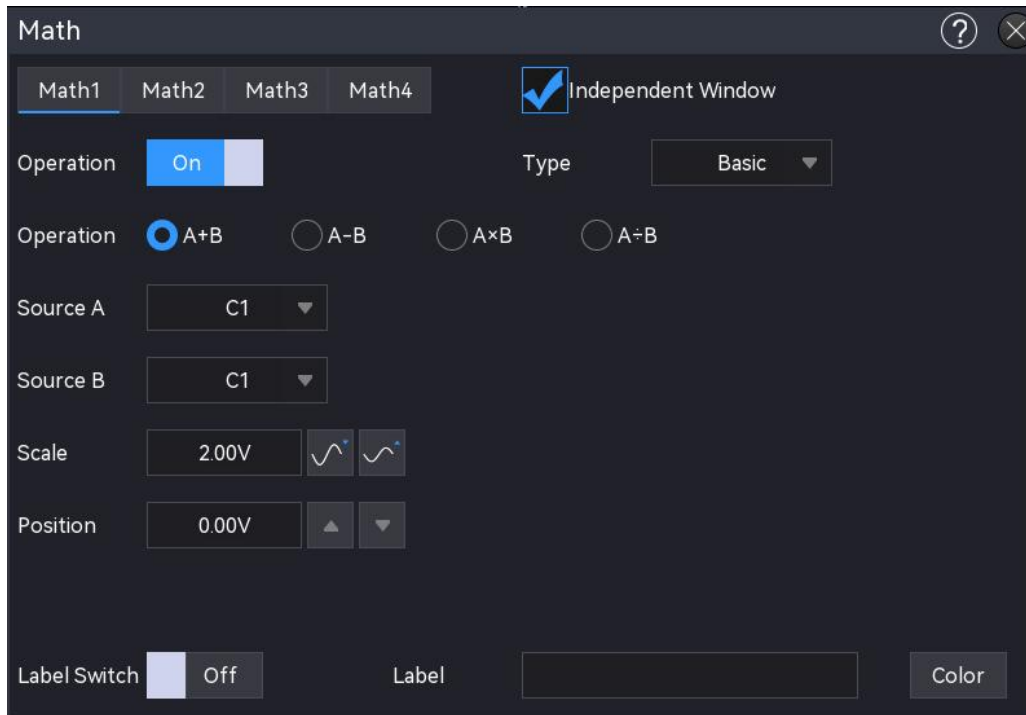

(1) Operation

- **A+B:** The waveform of source A and waveform of source B are added point by point and the results are displayed.
- **A-B:** The waveform of source A and waveform of source B are subtracted point by point and the results are displayed.
- **A×B:** The waveform of source A and waveform of source B are multiplied point by point and the results are displayed.
- **A÷B:** The waveform of source A and waveform of source B are divided point by point and the results are displayed. It is used to analyze the multiple relation between two channel waveforms.

Note: When the voltage of source B is 0, the divide result is 0.

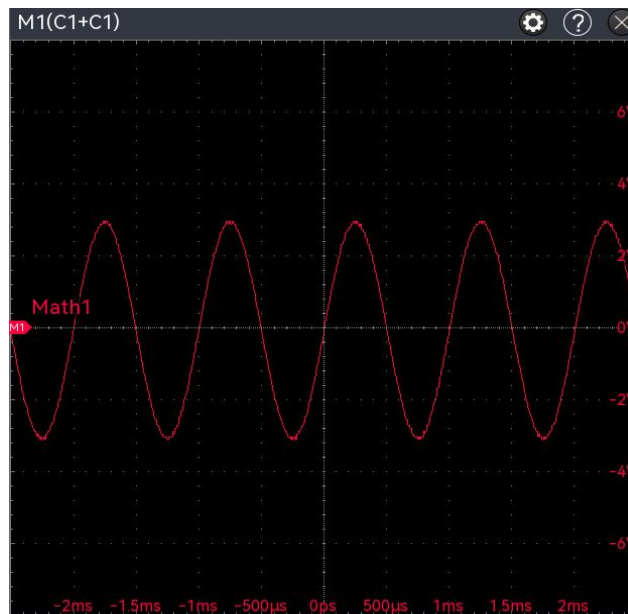



(2) Source

Click on the “Source A” or “Source B” to select C1-C4 separately.



(3) Vertical Scale

Set the vertical scale of Math wave in the display window, it can be set using the following steps.

- In “Math” menu, click on the “Vertical Scale” input field, rotate the Multipurpose A rotary knob on the front panel to change the vertical scale.
- Tap the vertical scale icon ,  on the right to increase or decrease the vertical scale.
- Double-click on “Vertical Scale” input field to open the numeric keypad to enter the specified numeric value. For details on the use of the numeric keypad, refer to the section of [5.8 Parameter Setting](#).

(4) Vertical Position

Set the vertical offset of Math wave in the display window, it can be set using the following steps.

- In “Math” menu, click on the “Vertical Position” input field, rotate the Multipurpose A rotary knob on the front panel to change the vertical position.
- Tap the vertical position icon ,  on the right to increase or decrease the vertical scale.
- Double-click on “Vertical Position” input field to open the numeric keypad to enter the specified numeric value. For details on the use of the numeric keypad, refer to the section of [5.8 Parameter Setting](#).

23.2. Digital Filter

In the “Math” menu, click on the “Math type” to select “Filter” to enter the setting.

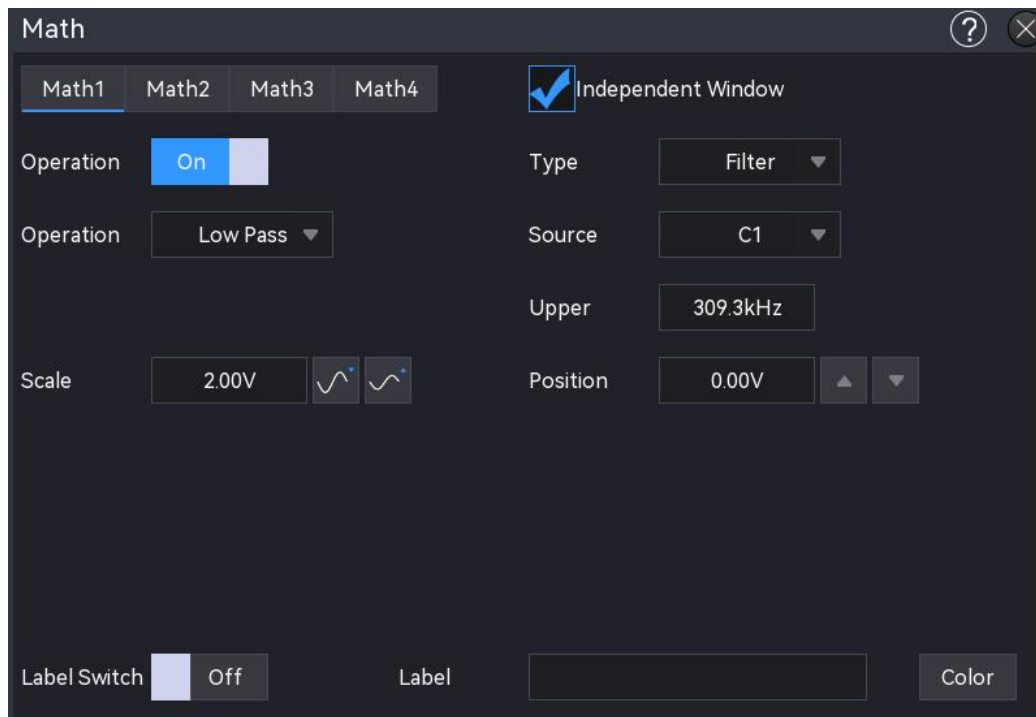

(1) Source

Click on the “Source” to select C1-C4.

(2) Filter Type

- Low pass: Only signals with the source frequency lower than the upper limit of the current frequency are allowed to pass.
- High pass: Only signals with the frequency higher than the lower limit of the current frequency are allowed to pass.
- Band pass: Only signal with the frequency higher than the lower limit of current frequency and lower than upper limit of the current frequency is allowed to pass.
- Band Limited: Only signal with the frequency lower than the lower limit of the current frequency or higher than the upper limit of the current frequency is allowed to pass.

(3) Lower Limit of Frequency

Click on the “Lower Limit of Frequency” input field, and rotate the Multipurpose A rotary knob on the front panel to change the lower limit of frequency; or double-click on “Lower Limit of Frequency” input field to open the numeric keypad to directly enter the lower limit of frequency. For details on the use of the numeric keypad, refer to the section of [5.8 Parameter Setting](#). In low-pass mode, the lower frequency limit setting is invalid, and the menu is hidden.



(4) Upper Limit of Frequency

Click on the “Upper Limit of Frequency” input field, and rotate the Multipurpose A rotary knob on the front panel to change the upper limit of frequency; or double-click on “Upper Limit of Frequency” input field to open the numeric keypad to directly enter the upper limit of frequency. For details on the use of the numeric keypad, refer to the section of [5.8 Parameter Setting](#). In high-pass mode, the upper frequency limit setting is invalid, and the menu is hidden.

Note: The range of upper/lower limit of frequency is related to the current horizontal time base.



(5) Vertical Scale

Set the vertical scale of Math wave in the operation result display window, it can be set using the following steps.

- In “Math” menu, click on the “Vertical Scale” input field, rotate the Multipurpose A rotary knob on the front panel to change the vertical scale.
- Tap the vertical scale icon ,  on the right to increase or decrease the vertical scale.
- Double-click on “Vertical Scale” input field to open the numeric keypad to enter the specified numeric value. For details on the use of the numeric keypad, refer to the section of [5.8 Parameter Setting](#).

(6) Vertical Position

Set the vertical offset of Math wave in the operation result display window, it can be set using the following steps.

- In “Math” menu, click on the “Vertical Position” input field, rotate the Multipurpose A rotary knob on the front panel to change the vertical position.
- Tap the vertical scale icon ,  on the right to increase or decrease the vertical position.
- Double-click on “Vertical Position” input field to open the numeric keypad to enter the specified numeric value. For details on the use of the numeric keypad, refer to the section of [5.8 Parameter Setting](#).

23.3. Advanced Operation

In the “Math” menu, click on the “Math type” to select “Advanced” to enter the setting. Advanced operations allow the user to freely define the relevant operations for each signal input channel to obtain Math waveforms with different operation results.

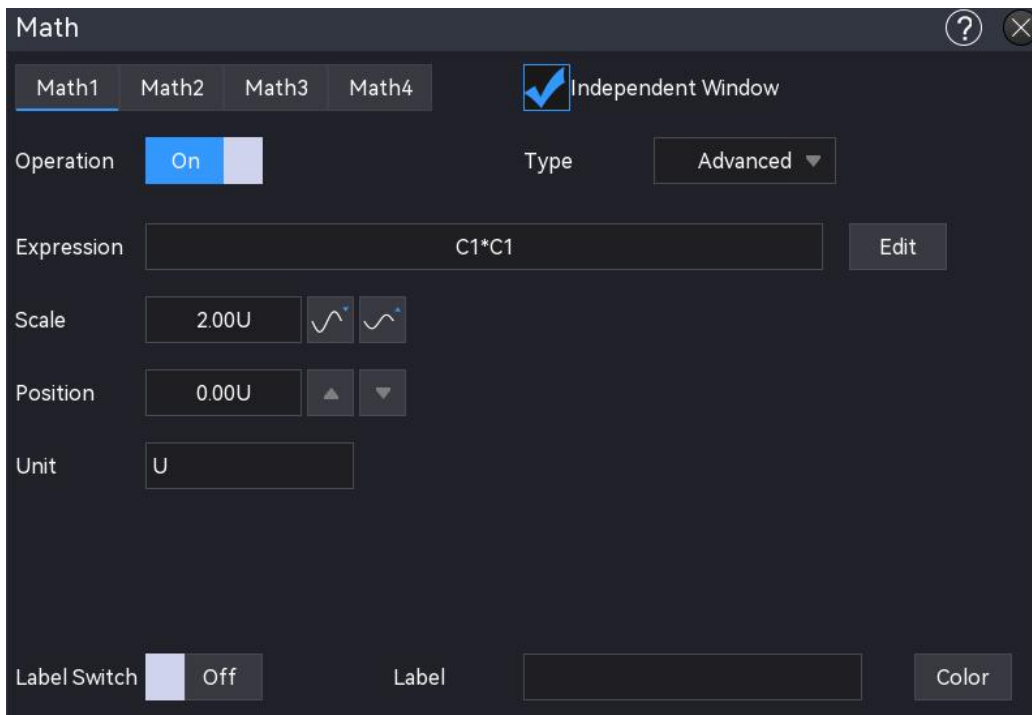

(1) Expression

Double-click on “Expression” input field or click the “Edit” on the right to enter the setting. The function operation can be edited in the expression window, as shown in the following figure.

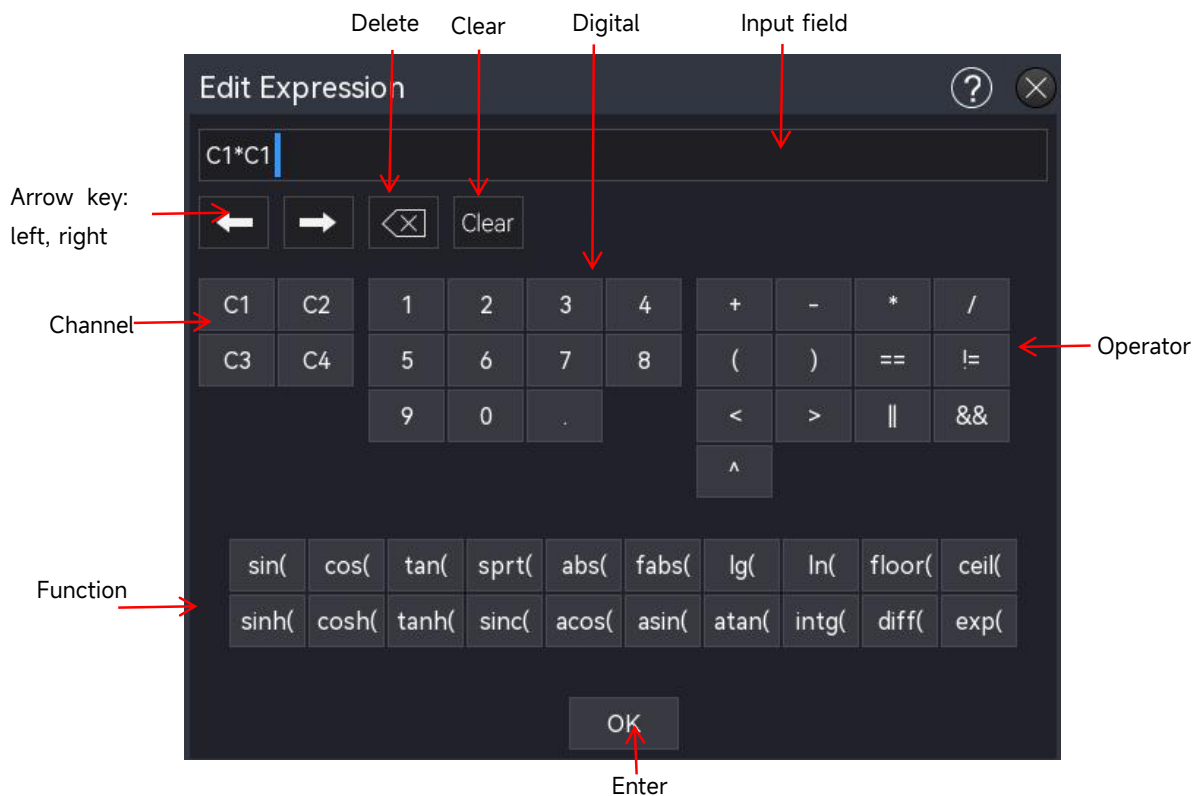

Expression Window

(2) Edit Expression

- a. Expression: It represents the formula consisting of channel, function, variation, and operator. The length of expression cannot be over 13 characters.
- b. Channel: C1-C4
- c. Function options: The functional description of each function option is shown in the following table.



Function Name	Description
Sin	Calculating the sine of the selected source.
Cos	Calculating the cosine of the selected source.
Sinc	Calculating the normalization value of the selected source.
Tan	Calculating the tangent of the selected source.
abs	The selected source takes the absolute value (integer absolute value).
fabs	The selected source takes the absolute value (floating number absolute value).
exp	Calculating the exponent of the selected source.
Lg	Calculating the logarithm of the selected source.
ln	Calculating the logarithm of the selected source.
floor	The selected source is round down to an integer.
ceil	The selected source is round up to an integer.
sinh	Calculating the hyperbolic sine of the selected source.
cosh	Calculating the hyperbolic cosine of the selected source.
tanh	Calculating the hyperbolic tangent of the selected source.
Sinc	Calculating the normalization value of the selected source.
acos	Calculating the arccosine of the selected source.
asin	Calculating the arcsine of the selected source.
atan	Calculating the inverse tangent of the selected source.
intg	Calculating the integral of the selected source.
diff	Calculating the differential of the selected source.

d. Operator: The functional description of each operator is shown in the following table.

Operator	Description
+ - * / ^	Mathematical operator: add, subtract, multiply, divide, exponent
()	Parentheses are used to raise the priority of operations in parentheses.
< > == !=	Relation operator: greater than, less than, equal to, unequal to
, &&	Logical operator: or, and
0-9	Perform digit operation



(3) Vertical Scale

Set the vertical scale of Math wave in the operation result display window, it can be set using the following steps.

- In “Math” menu, click on the “Vertical Scale” input field, rotate the Multipurpose A rotary knob on the front panel to change the vertical scale.
- Tap the vertical scale icon ,  on the right to increase or decrease the vertical scale.
- Double-click on “Vertical Scale” input field to open the numeric keypad to enter the specified numeric value. For details on the use of the numeric keypad, refer to the section of [5.8 Parameter Setting](#).

(4) Vertical Position

Set the vertical offset of Math wave in the operation result display window, it can be set using the following steps.

- In “Math” menu, click on the “Vertical Position” input field, rotate the Multipurpose A rotary knob on the front panel to change the vertical position.
- Tap the vertical scale icon ,  on the right to increase or decrease the vertical position.
- Double-click on “Vertical Position” input field to open the numeric keypad to enter the specified numeric value. For details on the use of the numeric keypad, refer to the section of [5.8 Parameter Setting](#).

(5) Unit





Set the result unit of mathematical advanced operations. Double-click on “Unit” input field to open the numeric keypad to enter the specified numeric value. For details on the use of the numeric keypad, refer to the section of [5.8 Parameter Setting](#).

24. FFT

Using FFT (Fast Fourier Transform) mathematical operations, the time domain signal (YT) can be converted into frequency domain signal. This oscilloscope has an FFT function. This allows the user to view the frequency spectrum of the signal while viewing the waveform in the time domain. The following types of signals can be easily observed by using FFT.

- Harmonic component and distortion in measurement system
- Perform the noise feature in DC power supply
- Vibration analysis

“FFT” menu can be entered using the following steps.

- Click the Home icon  in the top right corner and select the FFT icon  to open the FFT function.
- If the FFT function is added into the toolbar, click the FFT icon  in the toolbar in the top right corner to open the FFT function.
- When FFT1-FFT4 is opened, click on the FFT1~FFT4 label at the bottom of the screen, click on the icon  in the top right corner to open the FFT function.

The oscilloscope supports four FFT operations: FFT1, FFT2, FFT3, and FFT4, and the operation results are displayed in an independent window. In the "Math FFT" menu, press FFT1-FFT4 to select and set. In this chapter, FFT1 is used as an example to introduce the FFT function.

FFT setting menu has two submenus, “Normal” and “Trace”. Click on the “Normal” or “Trace” to set or slide the menu to select and set.

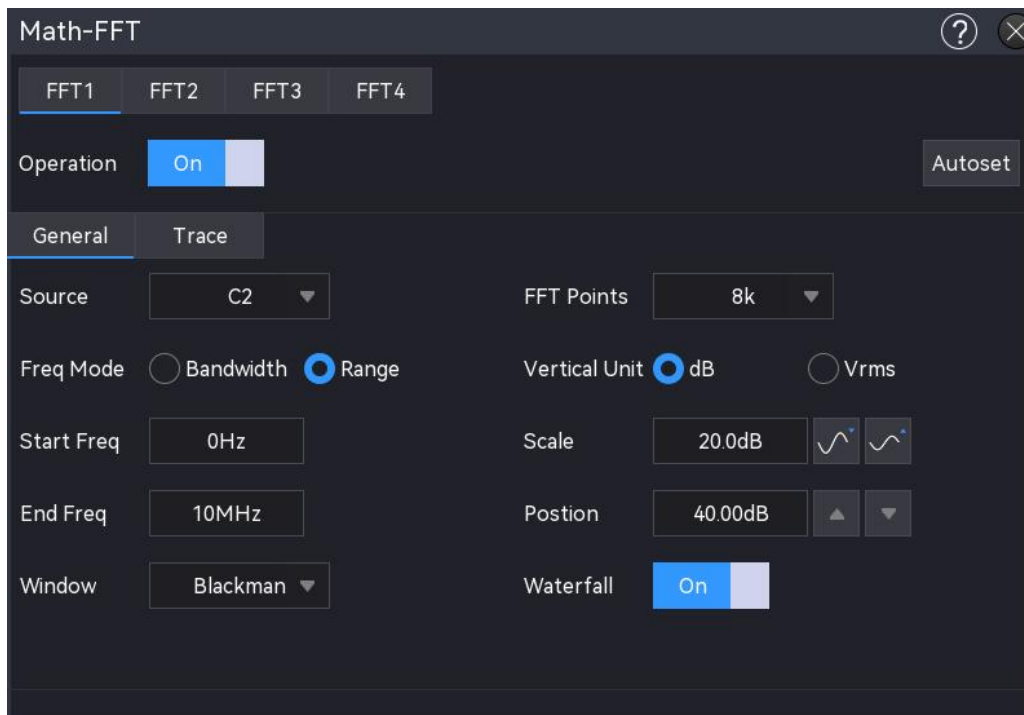

(1) Operation

Click on the "Operation" to open the FFT operation window.

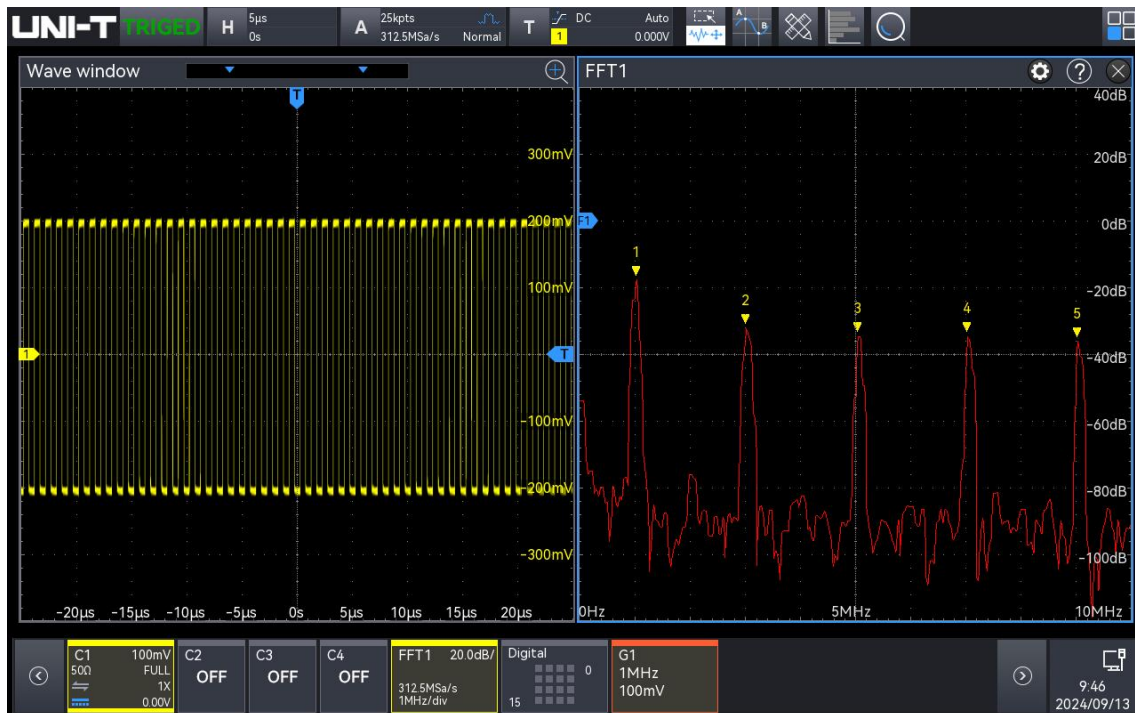

(2) Autoset

Click on the "Autoset" key to automatically adjust the vertical range and position, ensuring the FFT waveform is displayed in the center of the screen.

(3) Source

Click on the "Source" to select C1-C4.

(4) FFT Count

The number of points processed by the FFT spectrum, it can set to 8 k, 16 k, 32 k, 64 k, 128 k, 256 k, 512 k, 1 M, 2 M, or 4 M.

(5) Frequency Mode

a. Range

- Start frequency: Click the "Start Frequency" input field on the left of the window to open the numeric keypad to set the start frequency; or select the "Start Frequency" and rotate the Multipurpose A rotary knob to set the start frequency, turn clockwise to increase and anticlockwise to decrease.
- Stop frequency: Click the "Stop Frequency" input field on the right of the window to open the numeric keypad to set the stop frequency. For details on the use of the numeric keypad, refer to the section of [5.8 Parameter Setting](#). Alternatively, select the "Stop Frequency" input field, use the Multipurpose A to adjust the stop frequency, turn clockwise to increase and anticlockwise to decrease.

b. Bandwidth

- Center frequency: The frequency is corresponding to the center of window. Click the "Center Frequency" input field on the right of the window to open the numeric keypad to set the center frequency. For details on the use of the numeric keypad, refer to the section of [5.8 Parameter Setting](#). Alternatively, select the "Center Frequency" input field, use the Multipurpose A to adjust the center frequency, turn clockwise to increase and anticlockwise to decrease. The center frequency range can be set from 0 Hz to bandwidth $\div 2$.
- Bandwidth: The frequency range of frequency domain waveform, set the bandwidth for FFT sweep. Click the "Bandwidth" input field on the right of the window to open the numeric keypad to set the bandwidth. For details on the use of the numeric keypad, refer to the section of [5.8 Parameter Setting](#). Alternatively, select the "Bandwidth" input field, use the Multipurpose A to adjust the bandwidth, turn clockwise to increase and anticlockwise to decrease. The center frequency range can be set from 0 Hz to 2.5 GHz.

(6) Vertical Unit

FFT operation result unit can be set to Vrms or dB. Vrms and dBm display the vertical amplitude size in linear and decibel volts respectively. If the FFT spectrum needs to be displayed in a large dynamic range, dBm is recommended.

(7) Window Function



The window function is used to reduce the problem of spectral leakage. This oscilloscope provides 4 FFT window functions, each window function is for different waveforms, as shown in the following table, and the selection is based on the measured waveform and its features.

Window Function Table

Window function	Feature	Waveform
Rectangle	It has the best frequency resolution and the worst amplitude resolution, which is like the one with no window.	Transient or short pulse, the signal level is almost equal to before and after Equal amplitude sine wave with very similar frequency Wide-band random noise in a slowly changing spectrum
Hanning	Compared with the rectangle window, it has better frequency resolution, but poorer amplitude resolution.	Sine wave, period and narrow-band random noise
Hamming	The frequency resolution is slightly better than that of Hanning window.	Transient or short pulse, the signal level is very different before and after
Blackman	It has the best amplitude resolution, and the worst frequency resolution.	Single frequency signal, seeking for higher harmonic



(8) Vertical Scale

Set the vertical scale of FFT wave in the display window, it can be set using the following steps

- In “Math” menu, click on the “Vertical Scale” input field, rotate the Multipurpose A rotary knob on the front panel to change the vertical scale.
- Tap the vertical scale icon ,  on the right to increase or decrease the vertical scale.
- Double-click on “Vertical Scale” input field to open the numeric keypad to enter the specified numeric value. For details on the use of the numeric keypad, refer to the section of [5.8 Parameter Setting](#).

(9) Vertical Position

Set the vertical offset of FFT wave in the display window, it can be set using the following steps.

- In “Math” menu, click on the “Vertical Position” input field, rotate the Multipurpose A rotary knob on the front panel to change the vertical position.
- Tap the vertical position icon ,  on the right to increase or decrease the vertical scale.
- Double-click on “Vertical Position” input field to open the numeric keypad to enter the

specified numeric value. For details on the use of the numeric keypad, refer to the section of [5.8 Parameter Setting](#).

(10) Waterfall Curve

Click on the “Waterfall Curve” to switch on/off whether the waterfall curve is opened in FFT wave.

- ON: The spectrum and waterfall curve are split to upper and lower part for display, the waterfall curve reflects the change in dB value over time in the spectrum and has record function. The waterfall plot can only be selected when the Enhanced FFT is enabled. The record is up to 200 (the spectrum with respect to the waterfall curve).
- OFF: Displays FFT wave and its coordinates.



(11) Segment Selection

After opening the waterfall chart, the “Segment selection” can be configured while the oscilloscope is in the STOP state. By adjusting the segment selection, the spectrum waveform corresponding to a specific time point on the waterfall diagram can be viewed. Click on the “Segment selection” input field, use the Multipurpose A rotary knob on the front panel to adjust the segment selection. Alternatively, double-click on the “Segment selection” input box to open the numeric keypad to enter the specified numeric value. For details on the use of the numeric keypad, refer to the section of [5.8 Parameter Setting](#). The setting range is from 1 to 300.

(12) Trace

In FFT setting menu, click on the “Trace” or slide the menu to left and right to enter the trace setting menu. The trace is used to display the graph of the points drawn on the raw data after

the FFT operation.

a. Trace

- Normal: The spectrum waveform graph shows all the sampled values in real time, the spectrum waveform displays in red.
- Average: The spectrum waveform graph shows the average value of several points taken during the sampling interval; the spectrum waveform displays in blue.
 - Average time: Set the number of average calculation, double-click on the “Average time” input field to open the numeric keypad to set the average time. For details on the use of the numeric keypad, refer to the section of [5.8 Parameter Setting](#). Alternatively, select the parameter, use the [Multipurpose A](#) rotary knob adjust the average time. The setting range is from 2 to 8192. The greater the number, the smoother the average spectrum.
- Maximum hold: The spectrum waveform graph shows the maximum value of the data from multiple samples, and the spectrum waveform display in yellow.
- Minimum hold: The spectrum waveform graph shows the minimum value of the data from multiple samples, and the spectrum waveform display in grey.

b. Sampling Mode

- OFF: Turn off the current detection waveform.
- + Peak: It takes and displays the maximum value in each sample interval.
- - Peak: It takes and displays the minimum value in each sample interval.
- Average: It takes and displays the average value in each sample interval.
- Sampling: It takes and displays the first value in each sample interval.

(13) Marker

The spectrum marker is used to mark the point in the spectrum and display the frequency and voltage.

a. Auto

- Mark trace: Select the spectrum waveform as the marker source, i.e. the spectrum waveform generated by different types of detector mode. Click on the “Mark trace” to select normal, average, maximum hold, or minimum hold.
- Marker count: Set the maximum number of points that can be marked, double-click on “Marker count” input field to open the numeric keypad to set the marker count. For details on the use of the numeric keypad, refer to the section of [5.8 Parameter Setting](#). Alternatively, select the parameter, use the [Multipurpose A](#) rotary knob adjust the marker count. The setting range is from 1 to 10.
- Marker list: Click on the “Marker list” to switch on/off the marker list.

ON: Displays the marker list, count number, frequency, and voltage.

OFF: Not display the marker list.

b. Threshold

- Marker trace: Select the spectrum waveform as the marker source, i.e. the spectrum waveform generated by different types of detector mode. Click on the “Marker trace” to select normal, average, maximum hold, or minimum hold.
- Marker count: Set the maximum marker count. Double-click on the “Marker Count” input field to open the numeric keypad to set the marker count. For details on the use of the numeric keypad, refer to the section of [5.8 Parameter Setting](#). Alternatively, select the parameter, use the Multipurpose A rotary knob adjust the marker count. The setting range is from 1 to 10.
- Marker threshold: Set the compare condition, the marker will be displayed when the peak is greater than the set threshold; otherwise, the marker will not be displayed. Double-click on “Marker threshold” input field to open the numeric keypad to set the marker threshold. For details on the use of the numeric keypad, refer to the section of [5.8 Parameter Setting](#). Alternatively, select the parameter, use the Multipurpose A rotary knob adjust the marker threshold.

Marker list: Click on the “Marker list” to switch on/off the marker list.

ON: Displays the marker list, count number, frequency, and voltage.

OFF: Not display the marker list.

c. Manual: Move the marker cursor to any point on the trace by rotating the Multipurpose A rotary knob.

- Marker trace: Select the spectrum waveform as the marker source, i.e. the spectrum waveform generated by different types of detector mode. Click on the “Marker trace” to select normal, average, maximum hold, or minimum hold.
- Peak: Click on the “Peak” to automatically place the marker cursor line at the peak value of the trace.

Note: If the selected marker trace is not displayed, there is no marker point, and the trace can be marked until the trace is displayed.

25. Digital Channel



- [Basic](#)
- [Group](#)
- [Threshold](#)
- [Bus](#)
- [Label](#)

MSO1000HD series has 4 analog channels and 16 digital channels. For digital channel, the oscilloscope will compare the sampled voltage of each time to the preset logical threshold. If the voltage of sampling point is greater than threshold, it will save as logic 1. Otherwise, it will save as logic 0. The oscilloscope can intuitively display the logic 1 and logic 0 in figure. It's convenient for user to detect and analysis the error in circuit design (hardware and software design).

This chapter introduces how to use the digital channel of MSO1000HD series high-resolution oscilloscopes.

Before using the digital channel, use the accessory UT-M26 logical probe to connect to the oscilloscope and the device under test. For the use of logical probe, refer to <<UT-M26 Logical Probe User Manual>>.

The digital channel menu can be entered using the following steps.

- Press the  key on the front panel to enter the digital channel menu.
- Click the Digital icon  at the bottom of the screen to enter the digital channel menu.

25.1. Basic



- (1) Display: Click on the “Display” to switch on/off the digital channel.
 ON: When the channel is selected, the digital channel will be displayed on the screen.
 OFF: The digital channel will not be displayed on the screen even if the channel is selected.
 - (2) Channel: Select a channel to be the current channel, and display it in blue to distinguish from other channels.
 - (3) Channel selection: D0-D15 can be opened by pressing any one of channel. The selected channel is displayed in blur. When the display is opened, the selected channel will be displayed on the screen.
 - Select all: Quick select all the digital channels.
 - Delete: Quick delete the state of all the digital channels.
 - (4) Click on the “D15-D8, D7-D0” to quickly set the channel display state.
 ON: Select the digital channel of D15-D8, D7-D0.
 OFF: No digital channel is selected.
 - (5) Open/close group: the selected group is displayed in . If the group has a digital channel, the digital channel will be displayed on the screen (refer to Group for more details).
 - (6) Waveform size: Click on the “Waveform size” to set the waveform size to display in S (small), M (middle), or L (large). The default is S.
- Note:** L (large) can only be used when the open channel is not more than 8.
- (7) Waveform rank: Click on the “Waveform rank” to set the digital channel sequence, from up to

down. It can set to “D0-D15” or “D15-D0” . The default is “D0-D15”.

- (8) Delay time: When using an oscilloscope for actual measurements, the transmission delay of the probe cable can introduce a large error (zero offset).

Zero offset is defined as the offset of the intersection of the waveform and trigger level line from the trigger position.

Double-click on the “Delay Time” input field to open the numeric keypad to set the delay time.

For details on the use of the numeric keypad, refer to the section of [5.8 Parameter Setting](#).

Alternatively, select the parameter, use the Multipurpose A to change the delay time. The range can be set from -100 ns to 100 ns.

25.2. Group

The group setting can group or ungroup any of the 16 digital channels into 4 groups, a channel can be added to more than one group, and the background of the channel added to the current group is displayed in blue.

- (1) Group: Click on the “Group” to select group 1, group 2, group 3, or group 4
- (2) Select all: Add D0-D15 to the current group. And all the digital channels are displayed in blue.
- (3) Reset: Reset the digital channel in the current group to the default 4 digital channels.
- (4) Clear: Clear all the digital channels in the current group.

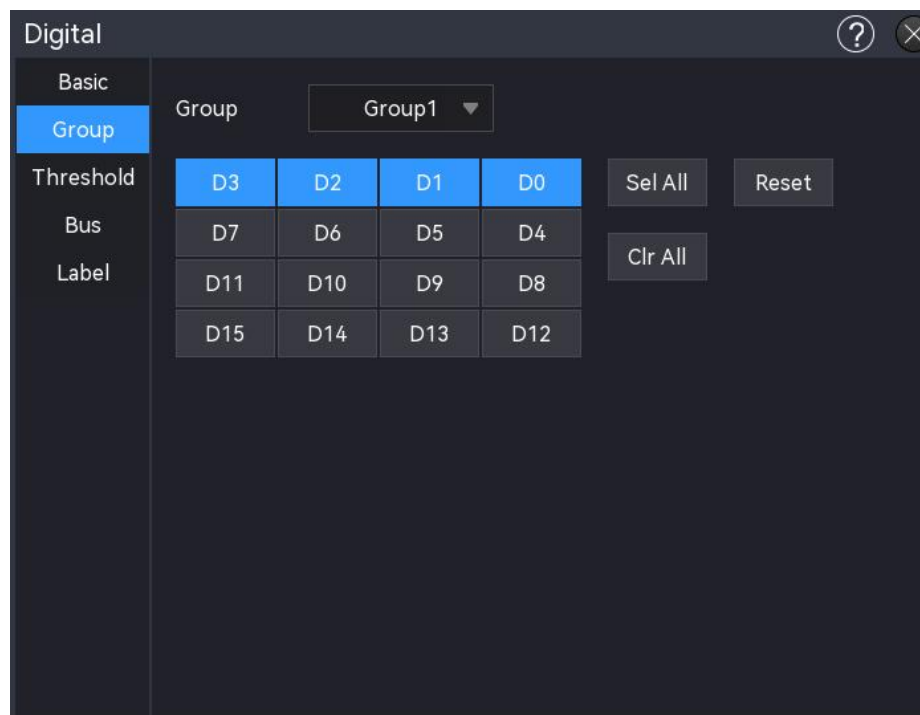

25.3. Threshold

The threshold levels for the "D7-D0" and "D15-D8" channels can be set independently, and the thresholds for CH1 and CH2 can also be configured independently as needed. If the input signal voltage exceeds the set threshold, it is recognized as logic 1; otherwise, it is recognized as logic 0. Click on the "D7-D0 Threshold" or "D15-D8 Threshold" to select the preset or custom value.

- (1) Preset threshold: TTL (1.4 V), CMOS5.0 (2.5 V), CMOS3.3 (1.65 V), CMOS2.5 (1.25 V), CMOS1.8 (0.9 V), ECL (-1.3 V), PECL (3.7 V), CLDS (1.2 V), and 0 V. Once the threshold is selected, it will apply to the group.
- (2) Custom: Click on the "Custom" to open the numeric keypad to set the custom threshold. For details on the use of the numeric keypad, refer to the section of [5.8 Parameter Setting](#). Alternatively, select the parameter, rotate the Multipurpose B rotary knob to select the cursor, and then rotate the Multipurpose A rotary knob to adjust the threshold. Turn the knob clockwise to increase the value and turn it anticlockwise to decrease the value. The range can be set from -20.0 V to +20.0 V.
- (3) Set the threshold for CH1 and CH2: Double click on the "CH1 Threshold / CH2 Threshold" input field to open the numeric keypad to set the delay time. For details on the use of the numeric keypad, refer to the section of [5.8 Parameter Setting](#). Alternatively, select the parameter, use the Multipurpose A to change the threshold. CH1 and CH2 thresholds are related to their volt/div.

25.4. Bus

Digital channels can be combined and displayed as bus, with each bus value displayed at the bottom of the screen as binary, decimal, hexadecimal, ASCII. The figure is displayed at the bottom of the screen. Up to two buses can be created.

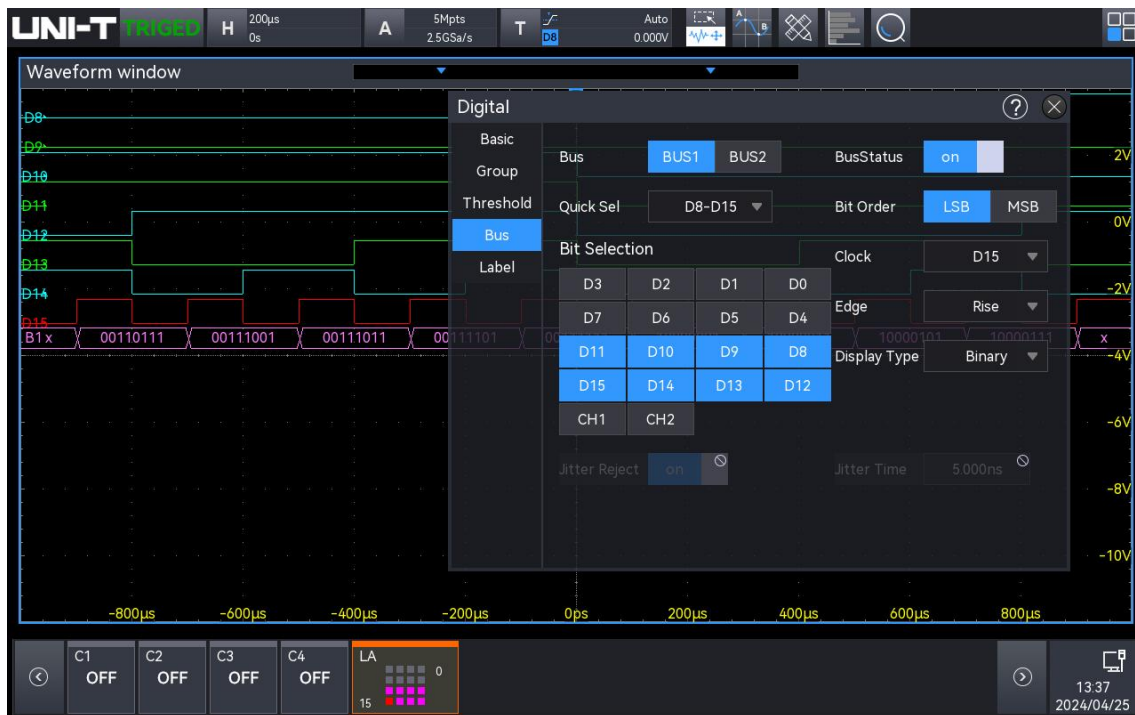

- (1) Bus: Click on the “Bus” to select the bus, “BUS1” or “BUS2”.
- (2) Bus state: Click on the “Bus state” to switch on/off the bus display state.
- (3) Quick selection: Click on the “Quick Selection” to select the channel group which correspond to BUS1 or BUS2, it can be select to D0-D7, D8-D15 , D0-D15, group 1, group 2, group 3, group 4, or None.
- (4) Bit selection: Manually select the channel bit that corresponds to the bus, it can be select to D0-D15, CH1, CH2, the selected digital channel is displayed in blue.
- (5) Bit sequence: Click on the “Bit Sequence” to select “LSB (low to high)” (D0 is at the low bit) or “MSB (high to low)” (D0 is at the high bit).
- (6) Clock: Click on the “Clock” to select any one of channel (D0-D15, CH1, CH2) to the reference clock for bus. The reference clock will not be set if “Null” is selected.
- (7) Edge type: Click on the “Edge type” to select “Rising/falling edge”. The edge type of the currently selected channel can be the reference, to judge other channel is logic 1 or logic 0.
- (8) Display type: Click on the “Display Type” to set the bus format to binary, decimal, hexadecimal, or ASCII. The oscilloscope will display the bus data as the level of the corresponding value in a specific way in the graphics mode, making it easy to observe the trend of the bus value, as shown in the following figure.
- (9) Jitter proof: Click on the “Jitter Proof” to switch on/off the jitter proof function.
 Jitter: It indicates the short-term deviation of a signal at a particular moment relative to its ideal time position. If the bus does not select the reference clock, the hopping state of each channel

will cause the change of the bus data. When bus data changes, unnecessary data will occur due to the shaking. When shake proof is opened, the bus will not display the change in bus data caused by a certain shake time, but still maintain the valid data.

- (10) Jitter time: Double-click on “Jitter Time” input field to open the numeric keypad to set the jitter time. For details on the use of the numeric keypad, refer to the section of [5.8 Parameter Setting](#). Alternatively, select the parameter, use the [Multipurpose A](#) to change the delay time. The range can be set from 0 ns to 50 μ s.

Note: Jitter proof and Jitter time can only be set when data bus has no reference clock.

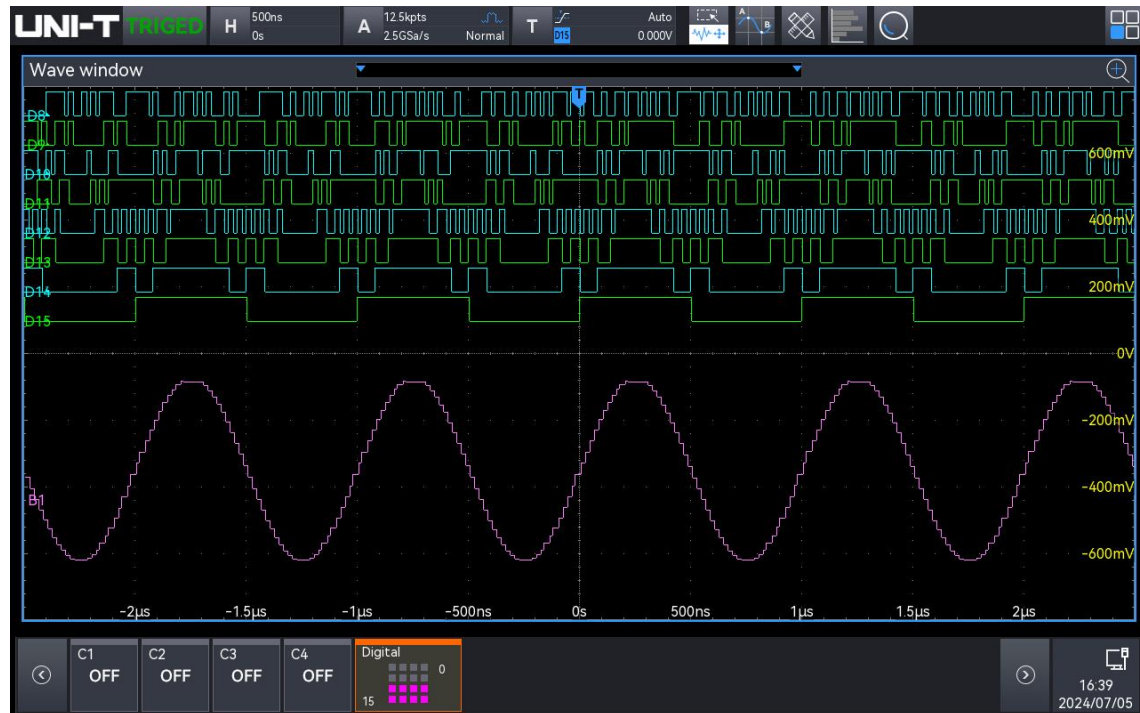

25.5. Label

Label setting is used to set the label for the specified digital channel.

- (1) Preset Label

Select a digital channel (D0-D7, D8-D15) and then select a preset label for it.

Preset label: ACK, AD0, ADDR, BIT, CAS, CLK, CS, DATA, HALT, INT, LOAD, NIMI, OUT, RAS, PIN, RDY, RST, RX, TX, WR, MISO, and MOSI.

- (2) Custom Label

Select a digital channel (D0-D7, D8-D15) and then set a custom label for it.

Double-click on the “Label” input field to open the numeric keypad to set the custom label. For details on the use of the numeric keypad, refer to the section of [5.8 Parameter Setting](#).

- (3) Clear label

Click on the "Clear" key to remove all labels set for the digital channels.

(4) Add

Click on the "Add" key to add custom labels that will display after the preset labels. The added labels can remain visible, with a maximum of 10 labels allowed. If you perform a default operation or click the "Restore Defaults" button, the added labels will be removed.

(5) Reset



Click on the "Reset" key to delete the added labels.

26. Search and Navigation



The search function allows the user to quickly find and highlight the events of interest, and then use the event navigation to quickly find the highlighted signals to view. Waveform search criteria can be set to edge, pulse width, slope, runt, window, delay, timeout, duration, setup & hold, Nth edge and code pattern. Navigation allows the user to quickly view and locate waveforms. Navigation includes time navigation, event navigation and frame segment navigation.

26.1. Search and Navigation

The search function can be opened by the following steps.

- Click the Home icon , select the search icon  to open the search function.
- If the search icon is added to the toolbar, click on the search icon  in the toolbar on the top right corner to open the search function.

The search function looks for waveform specific edge and pulse width events and marks them with small, inverted triangles  along the top of the waveform scale.

Click the Home icon  in the top right corner and select the search icon  to open the search function, as shown in the following figure.

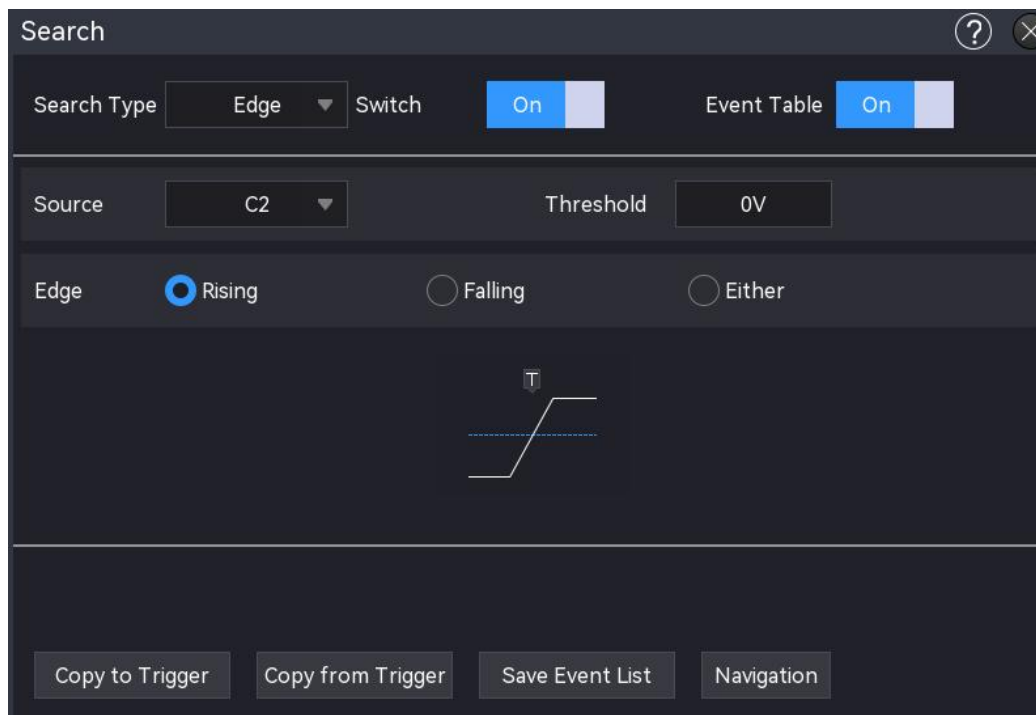

1. Turn on/off search function

Click on the "Search" to switch on/off search function.

2. Search Type



Click on the "Search Type" to select edge, pulse width, slope, runt, over-amplitude, delay, timeout, duration, setup & hold, Nth edge, and code pattern.

- Edge search: Click on the "Search Type" and select "Edge", for the edge type setting (source, trigger coupling, edge type, trigger level), refer to the section of ["Edge Trigger"](#).
- Pulse width search: Click on the "Search Type" and select "Pulse width", for the pulse width setting (source, polarity, upper limit, lower limit), refer to the section of refer to the section of ["Pulse Width Tigger"](#).
- Slope search: Click on the "Search Type" and select "Slope", for the slope setting (source, edge type, condition, upper limit of time, lower limit of time), refer to the section of refer to the section of ["Slope Trigger"](#).
- Runt search: Click on the "Search Type" and select "Runt", for the runt setting (source, polarity, runt condition, upper limit of time, lower limit of time), refer to the section of refer to the section of ["Runt Trigger"](#).
- Over-amplitude search: Click on the "Search Type" and select "Over-amplitude", for the Over-amplitude setting (source, edge type, search position, over-amplitude time), refer to the section of refer to the section of ["Over-amplitude Trigger"](#).
- Delay search: Click on the "Search Type" and select "Delay", for the delay setting (source, edge type, delay condition, upper limit of time, lower limit of time), refer to the section of refer to the section of ["Delay Trigger"](#).
- Timeout search: Click on the "Search Type" and select "Timeout", for the timeout setting (source, edge type, timeout type), refer to the section of refer to the section of ["Timeout Trigger"](#).
- Duration search: Click on the "Search Type" and select "Duration", for the timeout setting (source, code pattern, upper limit of time, lower limit of time), refer to the section of refer to the section of ["Duration Trigger"](#).
- Setup & Hold search: Click on the "Search Type" and select "Setup & Hold", for the setup & hold setting (data source, clock source, edge type, data type, trigger condition, time), refer to the section of refer to the section of ["Setup & Hold Trigger"](#).
- Nth edge search: Click on the "Search Type" and select "Nth edge", for the Nth edge setting (source, edge type, search position, time), refer to the section of refer to the section of ["Nth Edge Trigger"](#).
- Code pattern search: Click on the "Search Type" and select "Code pattern", for the code

pattern setting (source, code patter), refer to the section of refer to the section of “[Code Pattern Trigger](#)”.

3. Event Table

Click the switch on the right side of the “Event Table” to toggle the marker table display on or off. When the event table is enabled, the marker table interface is displayed as shown in the figure below. The marker table lists the events for markers on waveforms currently visible in the waveform view, updating dynamically as you zoom in or adjust the waveform. You can perform the following operations on the Marker Table:

- Clicking any row in the marker table while acquisition is stopped (STOP mode) selects the corresponding event, and the inverted triangle marker of the selected event turns red.
- Click the icon  in the top-right corner of the marker table to open the search menu.
- Press and hold the gray title bar above the event table to drag and reposition the window.
- Click the icon  in the top-right corner of the marker table to open the Help document.
- Click the icon  in the top-right corner of the marker table to close the marker table.



4. Copy to trigger

Click on the “Copy to Trigger” to copy the settings of the selected search type to its corresponding trigger type. For example, if the current search type is “Edge,” clicking “Copy to Trigger” will apply the edge search settings to the “Edge Trigger” settings.

5. Trigger Self-Copy

Click on the “Trigger Self-Copy” to copy the trigger settings of the selected trigger type to the search settings. For example, if the current trigger type is “Edge Trigger,” clicking “Trigger

Self-Copy” will copy the edge trigger settings to the “Edge” search settings.

To use the “Trigger Self-Copy” function, the search type should set first. Then, copy the corresponding trigger settings from the trigger menu.

6. Save Event Table

When the operating state is RUN/STOP, the time and decoding data in the current event list can be exported.

Click the “Save event table” key in the decoding menu to pop up the export setting menu, the data can be saved in *.csv , *.html, and *.pdf to internal storage or external USB disk drive (when a USB is detected).

For the setting steps, refer to the section of [Save and Load](#).

Note: When the operating state is RUN, the decoding data may be unstable, the user can manually stop the oscilloscope to export a stable decoding signal.



7. Navigation

Click on the “Navigation”key to jump to the navigation module.

26.2. Navigation

The navigation function includes time navigation, search event navigation, and marker navigation.

The navigation menu can be accessed by the following methods.

- Click the Home icon Home , select the navigation icon  to open the navigation function.
- If the navigation icon is added to the toolbar, click on the navigation icon  in the toolbar on the top right corner to open the navigation function.
- Click the “Navigation”key in search module to open the navigation function.

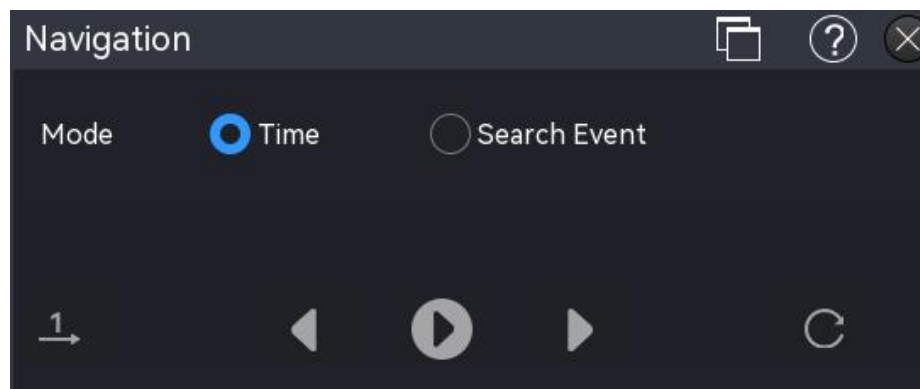

The navigation menu is shown in the figure above. Click the icon  in the menu to minimize the navigation menu and simplify the interface, as shown in the figure below.

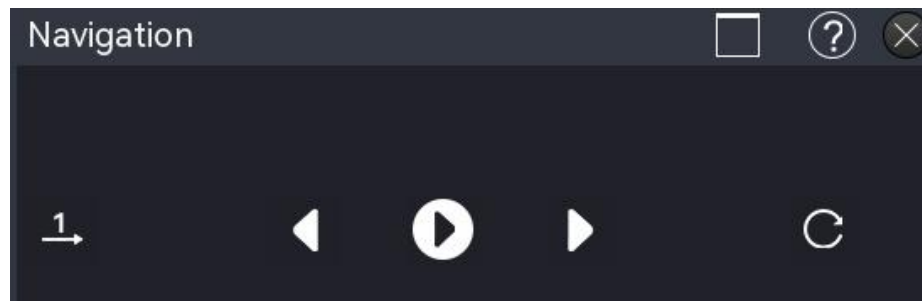



Note: The navigation function is only available when the operation status is STOP (acquisition stopped).



(1) Time Navigation

The time navigation mode is only available in the “YT” time base mode.

■ Playback

After selecting time navigation, click the key  in the menu to start or stop playback. Use the previous  or next key  to move the waveform. Playback will stop automatically when it reaches either end of the waveform.



■ Playback Mode

The playback mode is divided into two modes: single playback  and cycle playback . Click the icon in the lower left corner of the menu to switch the playback order.

: Playback starts from the start frame and ends at the end frame, stopping automatically.

: Click the icon in the bottom left corner of the screen to switch between modes.

■ Playback Order

The playback order can be set to sequential playback  or reverse playback . Click the icon in the lower right corner of the menu to switch the playback order.

: The waveform plays to the right of the center point of the screen, moving from the center to the left.

: The waveform plays to the left of the center point of the screen, moving from the center to the right.

(2) Search Event Navigation

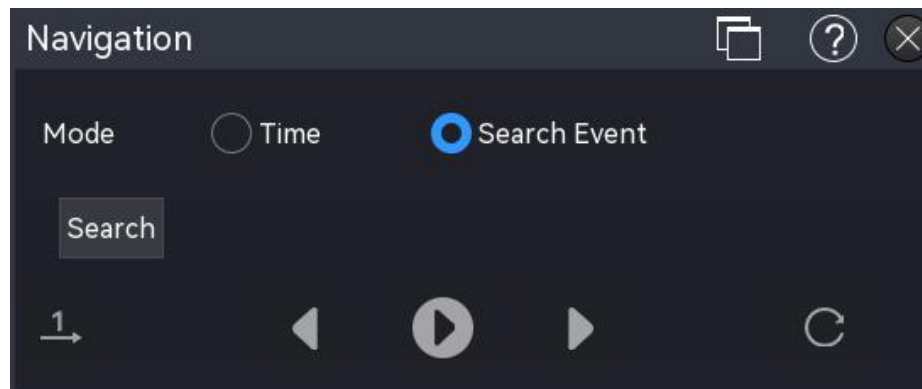

After completing an event search using the Search function, you can use the Search Event Navigation to quickly view the search events. The Search Event Navigator screen is shown below.





- Search

After selecting the Search Event Navigation in the navigation interface, you can click “Search” to open the “Search” menu and set the search conditions. Please refer to the Search Function for the relevant search settings.

- Playback

After selecting the search navigation, click the key  in the menu to start or stop playback. You can use the previous key  (left search point) or the next key  (right search point) to display the search points in the center of the screen. Playback will automatically stop when it reaches the leftmost or rightmost mark point.



- Playback Mode

The playback mode is divided into two modes: single playback  and cycle playback . Click the icon in the lower left corner of the menu to switch the playback order.

: Playback automatically stops after playing from the first search point to the last search point.

: Playback repeats from the first to the last search point until the operation is stopped manually.

- Playback Order



The playback order can be set to sequential playback  or reverse playback . Click the icon in the lower right corner of the menu to switch the playback order.

: Play from the leftmost search point to the rightmost search point.

: Play from the rightmost search point to the leftmost search point.





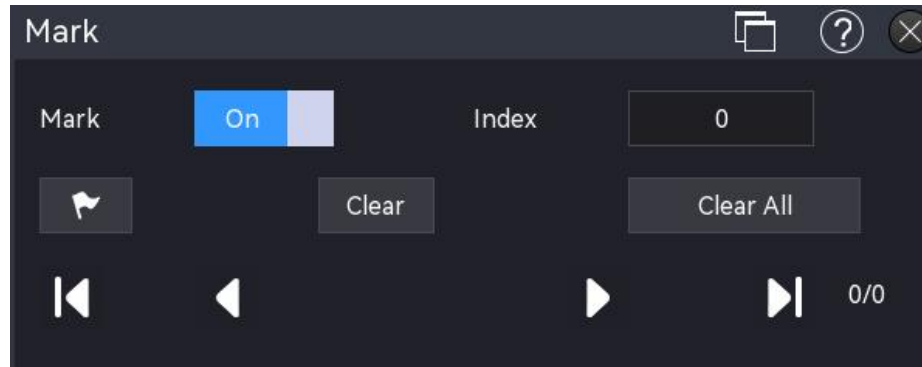

26.3. Marker Navigation

The marker navigation can be accessed by the following methods.

Click the Home icon Home , select the marker navigation icon  to open the marker navigation function.

If the navigation icon is added to the toolbar, click on the navigation icon  in the toolbar in the top right corner to open the marker navigation function.



- (1) Marker: Click to open the marker list.
- (2) Index: For the current navigation marker point, double-click the "Index" input field to open the numeric keypad to set this value. For details on the use of the numeric keypad, refer to the section of [5.8 Parameter Setting](#). Alternatively, use the [Multipurpose A](#) rotary knob to adjust this value.
- (3) : Mark the midpoint of the current waveform area with the marking symbol .
- (4) Clear: Clear the midpoint marker in the waveform area.
- (5) Clear all: Clear all markers.
- (6) Click the previous  key to navigate to the previous marker point (decreasing the marker index number), or click the next  key to navigate to the next marker point (increasing the marker index number). Click the  key to navigate to the first marker point or click the  key to navigate to the last marker point.



27. Function/Arbitrary Waveform Generator (Gen)

- [Open Function/Arbitrary Waveform Generator](#)
- [Carrier Waveform Output](#)
- [Advanced Application](#)

MSO1000HD has a built-in function/arbitrary waveform generator. It uses direct digital synthesis (DDS) technology to generate accurate and stable waveform outputs with a resolution as low as 1 μ Hz. MSO1000HD is an economical function/arbitrary waveform generator.

27.1. Open Function/Arbitrary Waveform Generator

The “Gen” can be entered using the following steps.

- Press the **Gen** key on the front panel to enter the “Gen” menu.
- Click the Home icon  in the top right corner and select the Gen icon  to enter the “Gen” menu.
- If the Gen function is added into the toolbar, click the counter icon  in the toolbar in the top right corner to enter the “Gen” menu.

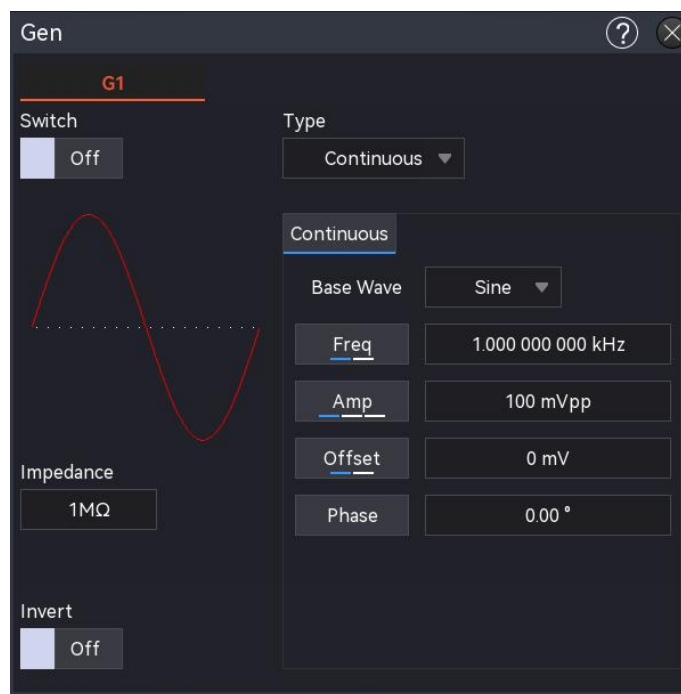

The oscilloscope supports one Gen signal output: G1

(1) Output Switch

Click on the “Output Switch” to set the G1 output state.

ON: Outputs the current G1 signal.

OFF: Does not output the G1 signal.

(2) Output Type

Click on the “Output Type” to select the output signal type to continuous waveform, AM waveform, or FM waveform, amplitude shift keying (ASK), frequency shift keying (FSK), and sweep.

(3) Output Impedance

Double-click on the “Output Impedance” input field to open the numeric keypad to set the impedance. For details on the use of the numeric keypad, refer to the section of [5.8 Parameter Setting](#). The selected output impedance must match with the impedance of the connected oscilloscope, otherwise, the amplitude and offset level of waveform on the screen will be incorrect.

(4) Reversed Output

Click on the “Reversed Output” to switch on/off the reversed output.

ON: Reverses the AC output signal.

OFF: The AC output signal will not be reversed.

(5) Waveform Parameter

Double-click on the parameter input field to open the numeric keypad to set the parameter. For details on the use of the numeric keypad, refer to the section of [5.8 Parameter Setting](#).

Alternatively, select the parameter, use the Multipurpose B rotary knob to move the cursor, and use the Multipurpose A rotary knob to adjust the parameter setting.

(6) Waveform figure: Displays the waveform of G1 signal.

27.2. Carrier Waveform Output

Gen can output waveforms from G1 individually or simultaneously. By default, when Gen is switched on, the instrument outputs a sine wave with a frequency of 1 kHz and an amplitude of 100 mVpp. This section introduces how to configure the instrument to output different types of waveforms.

(1) Waveform Type

Click on the “Carrier Wave” to select the waveform to sine, square, ramp, pulse wave, arbitrary, noise, or DC wave. For details on the parameters associated with each waveform, refer to the following table.

Continuous wave	Parameter	Frequency range	Amplitude range	Offset range
Sine wave	Frequency/cycle, amplitude/high level, DC offset/low level, phase ($\pm 360^\circ$)	1 μ Hz-25 MHz	20 mVpp-6 Vpp (high impedance); 10 mVpp-3 Vpp (50 Ω)	± 3 V (high impedance); ± 1.5 V (50 Ω)
Square wave	Frequency/cycle, amplitude/high level, DC offset/low level, phase ($\pm 360^\circ$), duty ratio (1%-99%)	1 μ Hz-10 MHz	20 mVpp-6 Vpp (high impedance); 10 mVpp-3 Vpp (50 Ω)	± 3 V (high impedance); ± 1.5 V (50 Ω)
Ramp wave	Frequency/cycle, amplitude/high level, DC offset/low level, phase ($\pm 360^\circ$), symmetry (0.1%-99.9%)/pulse width	1 μ Hz-400 kHz	20 mVpp-6 Vpp (high impedance); 10 mVpp-3 Vpp (50 Ω)	± 3 V (high impedance); ± 1.5 V (50 Ω)
Pulse wave	Frequency/cycle, amplitude/high level, DC offset/low level, phase ($\pm 360^\circ$), pulse width/ duty ratio (1%-99%), rising, falling edge	1 μ Hz-10 MHz	20 mVpp-6 Vpp (high impedance); 10 mVpp-3 Vpp (50 Ω)	± 3 V (high impedance); ± 1.5 V (50 Ω)
Arbitrary wave	Frequency/cycle, amplitude/high level, DC offset/low level, phase ($\pm 360^\circ$)	1 μ Hz-5 MHz	20 mVpp-6 Vpp (high impedance); 10 mVpp-3 Vpp (50 Ω)	± 3 V (high impedance); ± 1.5 V (50 Ω)
Noise	Amplitude/high level, DC offset/low level		20 mVpp-6 Vpp (high impedance); 10 mVpp-3 Vpp (50 Ω)	± 3 V (high impedance); ± 1.5 V (50 Ω)
DC	DC			± 3 V (high impedance); ± 1.5 V (50 Ω)

(2) Frequency

When Gen is switched on, the instrument will configure a default sine wave with a frequency of 1 kHz and an amplitude of 100 mVpp. Double-click on the "Frequency" input field to open the numeric keypad to set the frequency. For details on the use of the numeric keypad, refer to the section of [5.8 Parameter Setting](#). Alternatively, select the parameter, use the Multipurpose B rotary knob to move the cursor, and use the Multipurpose A rotary knob to adjust the frequency.

(3) Amplitude

The default waveform is a sine wave with an amplitude of 100 mVpp. Double-click on the “Amplitude” to open the numeric keypad to set the amplitude. For details on the use of the numeric keypad, refer to the section of [5.8 Parameter Setting](#). Alternatively, select the parameter, use the Multipurpose B rotary knob to move the cursor, and use the Multipurpose A rotary knob to adjust the amplitude.

(4) DC Offset

The default DC offset of waveform is 0 V. Double-click on the “DC Offset” to open the numeric keypad to set the DC offset. For details on the use of the numeric keypad, refer to the section of [5.8 Parameter Setting](#). Alternatively, select the parameter, use the Multipurpose B rotary knob to move the cursor, and use the Multipurpose A rotary knob to adjust the DC offset.

(5) Phase

The default phase of waveform is 0°. Double-click on the “Phase” to open the numeric keypad to set the phase. For details on the use of the numeric keypad, refer to the section of [5.8 Parameter Setting](#). Alternatively, select the parameter, use the Multipurpose B rotary knob to move the cursor, and use the Multipurpose A rotary knob to adjust the phase.

(6) Duty Ratio of Pulse Wave

The default frequency is 1 kHz, and the duty ratio is 50% of the pulse wave. Double-click on the “Duty Ratio” to open the numeric keypad to set the duty ratio. For details on the use of the numeric keypad, refer to the section of [5.8 Parameter Setting](#). Alternatively, select the parameter, use the Multipurpose B rotary knob to move the cursor, and use the Multipurpose A rotary knob to adjust the duty ratio.

(7) Rising/Falling Time

The default rising/falling time is 12 of the pulse waves. Double-click on the “Rising/Falling time” to open the numeric keypad to set the rising/falling time. For details on the use of the numeric keypad, refer to the section of [5.8 Parameter Setting](#). Alternatively, select the parameter, use the Multipurpose B rotary knob to move the cursor, and use the Multipurpose A rotary knob to adjust the rising/falling time.

(8) Ramp Symmetry

The default symmetry of ramp wave is 50%. Double-click on the “Symmetry” to open the numeric keypad to set the symmetry. For details on the use of the numeric keypad, refer to the section of [5.8 Parameter Setting](#). Alternatively, select the parameter, use the Multipurpose B rotary knob to move the cursor, and use the Multipurpose A rotary knob to adjust the symmetry.

27.3. Advanced Application

Gen can output amplitude modulation (AM), frequency modulation (FM), amplitude shift keying (ASK), frequency shift keying (FSK), and sweep. Press the Gen on the front panel to open the function/arbitrary waveform generator, and enter the Gen setting menu to set decode, and select the modulation type through the "Output type".

(1) Amplitude Modulation (AM)

In AM, the modulation waveform consists of carrier wave and modulation wave. The amplitude of carrier waves will change with the amplitude of modulation wave.

a. Enable AM

In G1 menu, select "Output Type" to "AM". Configure the parameters for the carrier wave and AM as shown in the following figure.



b. Select Carrier Wave

Click on the "Carrier Wave" to select sine, square, ramp, or arbitrary wave.

■ Carrier Wave Setting

Once the carrier wave for AM is selected, each parameter can be configured. For the carrier wave setting, refer to the section of [Carrier Waveform](#).

c. Modulation Wave Setting

Modulation wave: sine, square, square, rising ramp, falling ramp, arbitrary, and noise wave.

The default is sine wave. Once AM is enabled, the modulation wave displays the sine wave.

Click on the “Modulation Wave” to change the modulation wave type. For details on the modulation wave, refer to the following table.

Modulation Wave	Description
Square wave	Duty cycle is 50%.
Rising ramp	Symmetry is 100%.
Falling ramp	Symmetry is 0%.
Arbitrary wave	Use automatic sampling to limit the arbitrary wavelength at 4 kpts.
Noise	White Gaussian noise

■ Modulation Frequency

The modulation frequency range is 2 mHz ~ 50 kHz (default 100 Hz). Once AM is enabled, the default modulation frequency will be displayed. Double-click on the “Modulation Frequency” input field to open the numeric keypad to set the modulation frequency. For details on the use of the numeric keypad, refer to the section of [5.8 Parameter Setting](#). Alternatively, select the parameter, use the Multipurpose B rotary knob to move the cursor, and use the Multipurpose A rotary knob to adjust the modulation frequency.

■ Modulation Depth

The modulation depth indicates the change of amplitude, expressed in percentage. AM modulation depth is from 0% to 120%. The default is range is 100%. Double-click on the “Modulation Depth” input field to open the numeric keypad to set the modulation depth. For details on the use of the numeric keypad, refer to the section of [5.8 Parameter Setting](#). Alternatively, select the parameter, use the Multipurpose B rotary knob to move the cursor, and use the Multipurpose A rotary knob to adjust the modulation depth.

- When the modulation depth is 0%, it outputs a constant amplitude (half the amplitude of the carrier wave amplitude).
- When the modulation depth is 100%, the output amplitude is change with the modulation wave.
- When the modulation depth is greater than 100%, the output amplitude will not over than 10 Vpp (the load is 50 Ω).

(2) Frequency Modulation (FM)

In FM, the modulation waveform consists of carrier wave and modulation wave. The frequency of carrier waves will change with the amplitude of modulation waves.

a. Enable FM

In G1 menu, select “Output Type” to “FM”. Configure the parameters for the carrier wave and FM as shown in the following figure.

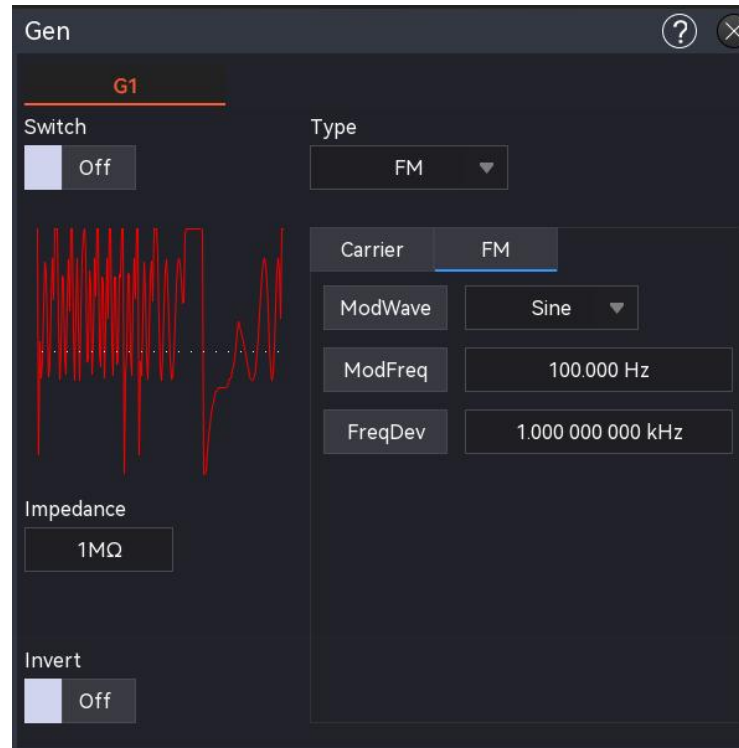

b. Select Carrier Wave

Click on the “Carrier Wave” to select sine, square, ramp, or arbitrary wave.

- Carrier Wave Setting

Once the carrier wave for FM is selected, each parameter can be configured. For the carrier wave setting, refer to the section of [Carrier Waveform](#).

c. Modulation Wave Setting

Modulation wave: sine, square, square, rising ramp, falling ramp, arbitrary, and noise wave. The default is sine wave. Once FM is enabled, the modulation wave displays the sine wave. Click on the “Modulation Wave” to change the modulation wave type. For details on the modulation wave, refer to the following table.

Modulation Wave	Description
Square wave	Duty cycle is 50%.
Rising ramp	Symmetry is 100%.
Falling ramp	Symmetry is 0%.
Arbitrary wave	Use automatic sampling to limit the arbitrary wavelength at 4 kpts.
Noise	White Gaussian noise

- Modulation Frequency

The modulation frequency range is 2 mHz-50 kHz (default 100 Hz). Once FM is enabled, the default modulation frequency 100 Hz will be displayed. Double-click on the “Modulation Frequency” input field to open the numeric keypad to set the modulation frequency. For details on the use of the numeric keypad, refer to the section of [5.8 Parameter Setting](#). Alternatively, select the parameter, use the Multipurpose B rotary knob to move the cursor, and use the Multipurpose A rotary knob to adjust the modulation frequency.

- Frequency Offset

The frequency offset indicates the offset of the frequency of the FM-modulated waveform relative to the carrier frequency, and the FM frequency offset can be set from the minimum DC to half the maximum current carrier bandwidth, and the default frequency offset is 100 Hz. Double-click on the “Frequency Offset” input field to open the numeric keypad to set the frequency offset. For details on the use of the numeric keypad, refer to the section of [5.8 Parameter Setting](#). Alternatively, select the parameter, use the Multipurpose B rotary knob to move the cursor, and use the Multipurpose A rotary knob to adjust the frequency offset. The maximum frequency offset is 12.5 MHz.

- Frequency offset \leq Carrier frequency, if the frequency offset is greater than the carrier frequency, the instrument will automatically limit the frequency offset to the maximum of the current carrier frequency.
- The sum of frequency offset and carrier frequency \leq Maximum frequency of the current carrier wave, if the frequency offset is set to an invalid value, the instrument will automatically limit the frequency offset to the maximum of the current carrier frequency.

(3) Output Arbitrary Wave

This oscilloscope has saved 200 arbitrary waves, refer to Table Built-in Arbitrary Wave List.

- Enable Arbitrary Wave Function

Click on the “Continuous” to select “Arbitrary Wave” to enable this function. The instrument will output the arbitrary wave according to the current setting, as shown in the following figure.

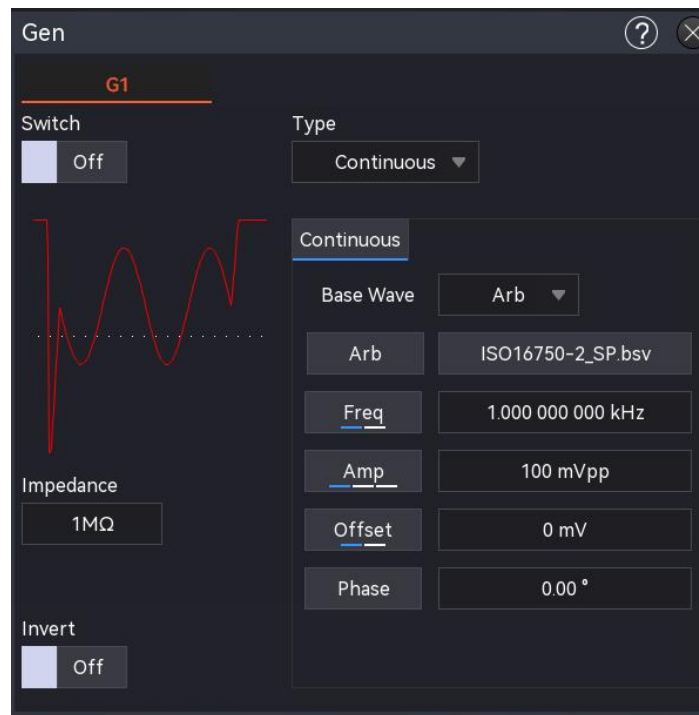

- Select Arbitrary Wave

The user can select the local built-in arbitrary wave or external arbitrary wave. Once the arbitrary wave is enabled, double-click on “Arbitrary Wave” to select the required arbitrary wave.

Load the saved waveform from Gen, which includes common waveforms, mathematical waveforms, segmented modulation, biological waveforms, medical waveforms, automotive waveforms, engineering waveforms, window functions, trigonometric functions, inverse trigonometric functions, noise, and more. The specific content of the list please refer to [Appendix B Built-in Arbitrary Wave Table](#).

(4) Amplitude Shift Keying (ASK)

In amplitude shift keying (ASK), digital signals “0” and “1” are represented by varying the amplitude of the fundamental signal. The system outputs different amplitudes based on the logic level of the modulating signal. The modulation modes of each channel are independent of one another, allowing users to configure either the same or different modulation modes for each channel.

- a. Enable ASK

In G1 menu, select “Output Type” to “ASK”. Configure the parameters for the carrier wave and ASK as shown in the following figure.

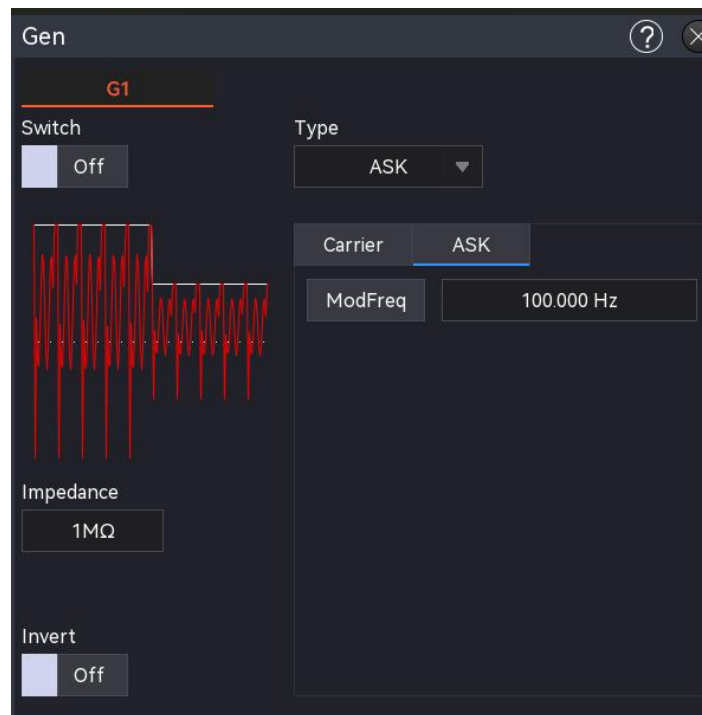

b. Select Carrier Wave

Click on the “Carrier Wave” to select sine, square, ramp, or arbitrary wave.

■ Carrier Wave Setting

Once the carrier wave for ASK is selected, each parameter can be configured. For the carrier wave setting, refer to the section of [Carrier Waveform](#).

c. Modulation Wave Setting

The modulation speed should be configured.

■ Modulation Speed

Once the ASK is enabled, the modulation speed should be configured. Double-click on the “Modulation Speed” input field to open the numeric keypad to set the modulation speed. For details on the use of the numeric keypad, refer to the section of [5.8 Parameter Setting](#). Alternatively, select the parameter, use the [Multipurpose B](#) rotary knob to move the cursor, and use the [Multipurpose A](#) rotary knob to adjust the modulation speed.

(5) Frequency Shift Keying (FSK)

In frequency shift keying (FSK), the function/arbitrary waveform generator can be configured to switch between two preset frequencies: the fundamental frequency and the hopping frequency. Depending on the logic state of the modulating signal, either the fundamental frequency or the hopping frequency is output. The modulation modes for each channel are independent, allowing users to configure the same or different modulation modes for each channel.

a. Enable FSK

In G1 menu, select “Output type” to “FSK”. Configure the parameters for the carrier wave and FSK as shown in the following figure.

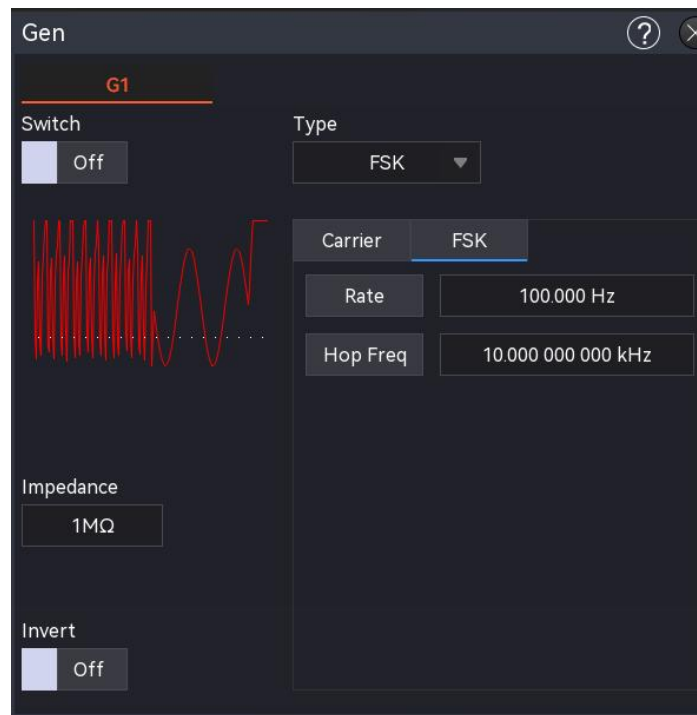

b. Select Carrier Wave Setting

Click on the “Carrier Wave” to select sine, square, ramp, or arbitrary wave.

■ Carrier Wave

Once the carrier wave for FM is selected, each parameter can be configured. For the carrier wave setting, refer to the section of [Carrier Waveform](#).

c. Modulation Wave Setting

The hopping frequency and rate should be configured.

■ Hopping Frequency

Once FSK is enabled, the default hopping frequency 100 Hz will be displayed.

Double-click on the “Hopping Frequency” input field to open the numeric keypad to set the hopping frequency. For details on the use of the numeric keypad, refer to the section of [5.8 Parameter Setting](#). Alternatively, select the parameter, use the [Multipurpose B](#) rotary knob to move the cursor, and use the [Multipurpose A](#) rotary knob to adjust the hopping frequency. The setting range for the hopping frequency is determined by the carrier wave. For the specific setting range of each carrier wave, refer to the section of [Carrier Waveform](#).

■ Rate

Once FSK is enabled, the default rate 100 Hz will be displayed. Double-click on the

“Rate” input field to open the numeric keypad to set the rate. For details on the use of the numeric keypad, refer to the section of [5.8 Parameter Setting](#). Alternatively, select the parameter, use the Multipurpose B rotary knob to move the cursor, and use the Multipurpose A rotary knob to adjust the rate.

(6) Sweep

When the sweep mode is selected, the output frequency of the Function/Arbitrary Waveform Generator varies linearly or logarithmically from the start frequency to the stop frequency within the specified sweep time. The generator can produce Sine, Square, Ramp, Pulse, and Arbitrary waveforms (excluding DC) as sweep outputs. The sweep modes for each channel operate independently, allowing you to configure the same or different sweep modes for each channel.

a. Enable Sweep

In G1 menu, select “Output type” to “Sweep”. Configure the parameters for the carrier wave and sweep as shown in the following figure.

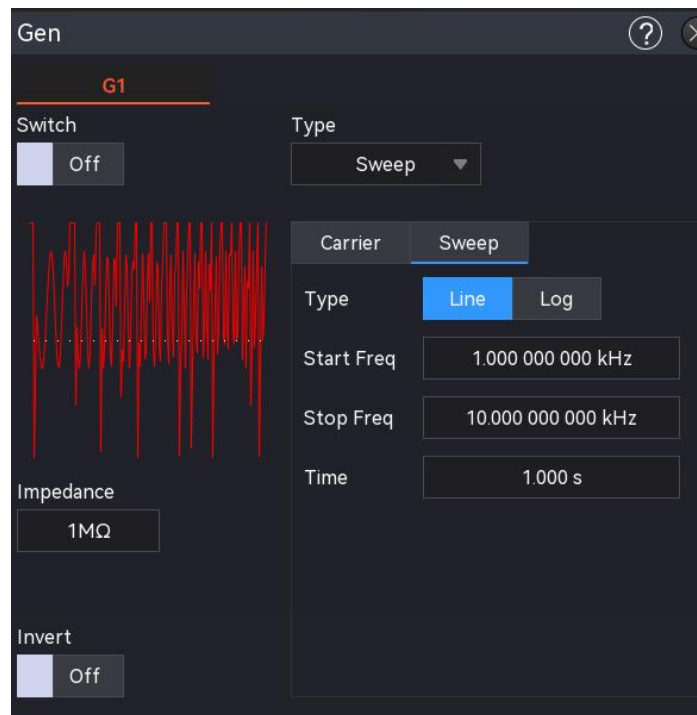

b. Select Carrier Wave Setting

Click on the “Carrier Wave” to select sine, square, ramp, or arbitrary wave.

■ Carrier Wave Setting

Once the carrier wave for sweep is selected, each parameter can be configured. For the carrier wave setting, refer to the section of [Carrier Waveform](#).

c. Sweep Setting

The start frequency, stop frequency, and sweep time should be configured.

■ Sweep Type

The function/arbitrary waveform generator supports two types of sweeps: linear and logarithmic

- ① Linear Sweep: The waveform generator changes the output frequency linearly throughout the sweep.
- ② Logarithmic Sweep: The waveform generator changes the output frequency logarithmically during the sweep.

■ Start Frequency, Stop Frequency

The start frequency and stop frequency represent the lower and upper limits of the frequency scan. The function/arbitrary waveform generator always sweeps from the start frequency to the stop frequency and then returns to the start frequency.

Double-click on the “Start Frequency/ Stop Frequency” input field to open the numeric keypad to set the frequency. For details on the use of the numeric keypad, refer to the section of [5.8 Parameter Setting](#). Alternatively, select the parameter, use the Multipurpose B rotary knob to move the cursor, and use the Multipurpose A rotary knob to adjust the rate frequency.

- ① When the start frequency < stop frequency, the function/arbitrary waveform generator scans from low frequency to high frequency.
- ② When the start frequency > stop frequency, the function/arbitrary waveform generator scans from high frequency to low frequency.
- ③ When the start frequency = stop frequency, the function/arbitrary waveform generator outputs a fixed frequency.

By default, the start frequency is set to 1 kHz and the stop frequency to 2 kHz. However, the range of configurable starting and stopping frequencies varies for different sweep waveforms. Amplitude modulation for the frequency setting ranges of each sweep waveform, refer to the section of [Carrier Waveform](#).

■ Sweep Time

Set the time required to sweep from the start frequency to the stop frequency. The default is 1 second, with a configurable range of 1 ms to 500 s. Double-click on the “Sweep Time” input field to open the numeric keypad to set sweep time. For details on the use of the numeric keypad, refer to the section of [5.8 Parameter Setting](#).

Alternatively, select the parameter, use the Multipurpose B rotary knob to move the cursor, and use the Multipurpose A rotary knob to adjust the sweep time.

28. Toolbar

Click on the Home icon  in the top right corner of the screen, click the “Edit” key at the bottom to enter the toolbar menu. The toolbar allows you to edit, delete, and adjust shortcut menu icons.



(1) Add toolbar

The toolbar contains all the function icon that can be added to the toolbar. Click to select the function to be added to the toolbar, click it again to deselect. The selected icon displays ✓ in the top right corner. A maximum of 9 function icons can be added to the tool bar.

(2) Sequence

In the toolbar pop-up box, the function menu added to the toolbar can be adjusted by dragging the corresponding icons left and right, to adjust the order of the icons displayed in the toolbar.

(3) Default setting

By default, MSO1000HD toolbar displays 5 icons: Zone drawing, Cursor, Measurement, Zone Histogram, and Search.





(4) Delete

Delete all the menus from the toolbar.

29. Region Histogram



The region histogram provides a probabilistic count of the vertical and horizontal direction of the waveform, showing the number of times the waveform crosses (or triggers) rows and columns in a user-defined window, which can help the user quickly analyse potential anomalies in the signal. The region histogram is divided into vertical and horizontal histograms. The window is divided into several rows and columns. When the histogram is open, the default size of the measurement window is ± 2 divisions (vertical/horizontal). Click and drag the histogram measurement window to move its position.

The region histogram can be entered using the following steps.

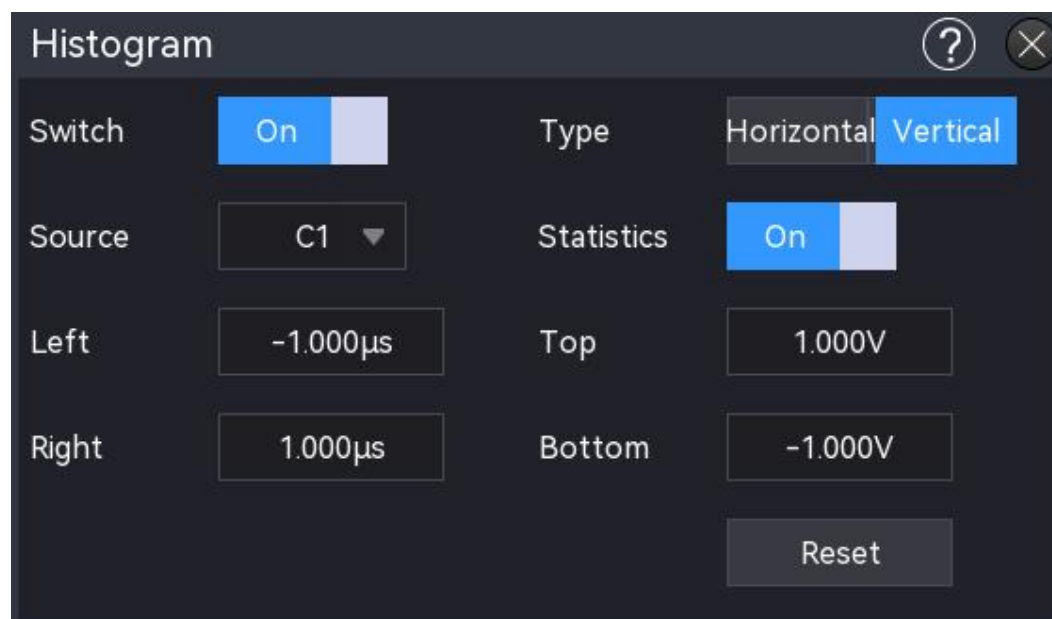
- Click the Home icon  in the top right corner and select the region histogram icon  to open the region histogram menu.
- If the region histogram is added to the toolbar, click the region histogram icon  to open the region histogram menu.
- When the region histogram pop-up box is opened, click the icon  to open the region histogram menu.



(1) Switch

Click on the “On/Off” switch to toggle the histogram function to on or off. When the function is ON, the histogram icon  is highlighted; when it is OFF, the histogram icon is not highlighted .

(2) Type

Click on the "Type" to select the histogram statistic type.

- Horizontal: Divides the limit window into multiple columns and displays the number of triggers in each column as a histogram at the bottom of the grid.
- Vertical: Splits the limit window into rows and displays the number of triggers in each row as a histogram on the left side of the grid.

(3) Source

Click on the "Source" down menu to select the source for histogram statistical analysis. The available source channels are analog channels C1 to C4.

(4) Histogram Statistics

Click the "On/Off" switch to toggle the statistics function to on or off.

- ON: The histogram statistics pop-up box is displayed.
- OFF: The histogram statistics pop-up box is not displayed.

(5) Histogram Boundary

The histogram measurement window allows you to set the left/right and upper/lower boundaries. When the histogram is opened, a default histogram area is generated. There are two methods to set the boundaries.

- In the histogram pop-up box, select the input boxes for "Left Boundary," "Right Boundary," "Upper Boundary," and "Lower Boundary." Rotate the Multipurpose A knob on the front panel to modify the boundary values. This operation is suitable for fine-tuning the boundaries to fit the screen area.
- Select the four histogram boundaries and drag them to modify the size of the measurement window. This operation is more suitable for coarse adjustments of the boundaries.

(6) Reset

Click on the "Reset" key will zero out the histogram statistics and restart the counting.

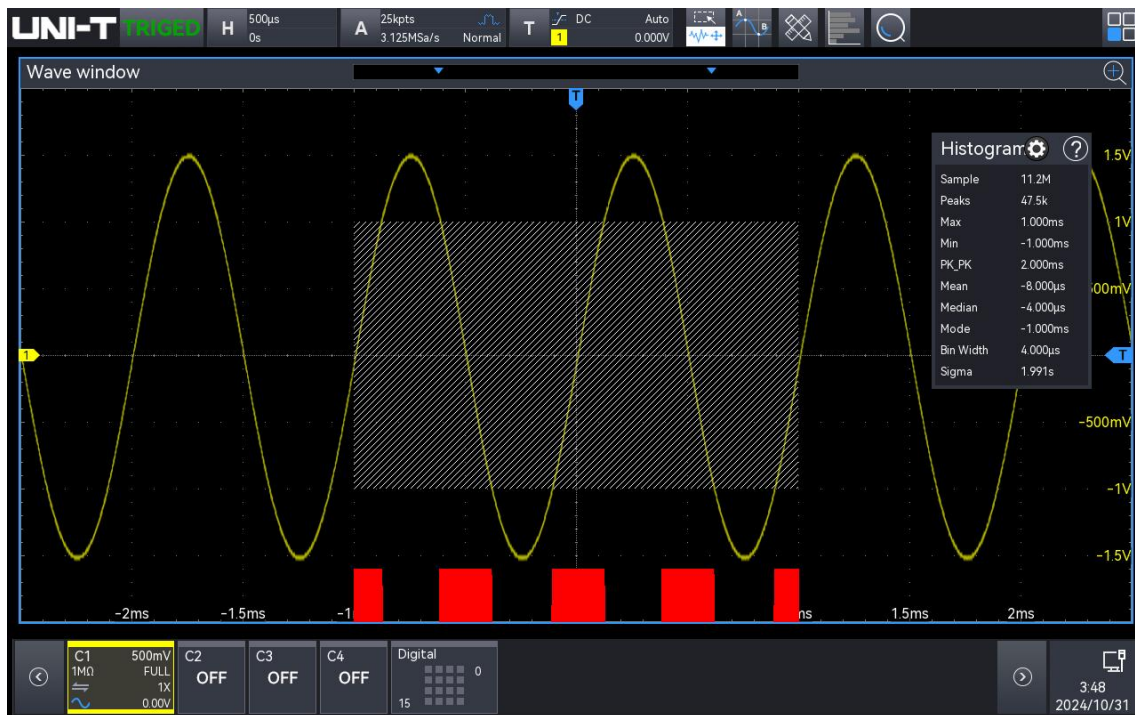

The visual component of the histogram is a bar graph displayed to the left of the vertical waveform histogram or at the bottom of the horizontal waveform histogram. As waveforms are acquired and displayed, or as measurements are made, the size of the bar graph changes to reflect the peaks of the triggered quantities within the specified histogram size.

(7) Histogram Statistical Results

The results of the histogram data are displayed in the Histogram Statistics pop-up box, which can be opened to view the statistics.

- **Sample:** The total number of samples that fall within the histogram area.
- **Peaks:** The number of samples that fall within the highest bar area.
- **Max:** The maximum value in the sample.
- **Min:** The minimum value in the sample.
- **Pk-Pk:** The difference between the maximum and minimum values.
- **Mean:** The average of all statistical samples (mathematical expectation).
- **Median:** The value that divides the histogram into two equal parts, each containing the same number of samples.
- **Mode:** The most frequently occurring data value in the statistical sample.
- **Bin Width:** The width of each bar in the histogram, representing the width of a column.
- **Sigma:** The standard deviation (σ) of all statistical samples.

30. Help System

The help system provides information about the function keys (including menu keys) on the front panel.

The user can access the help system by following these steps.

- In Home menu, click on the help icon “?” to open the help menu.
- In each function menu popup, click on the help icon “?” in the top right to open the relevant help menu.

The help screen is divided into two parts, the left side is “Help Options”, and the right side is “Help Display Area”. By selecting a help option, you can view all related help content on the right.

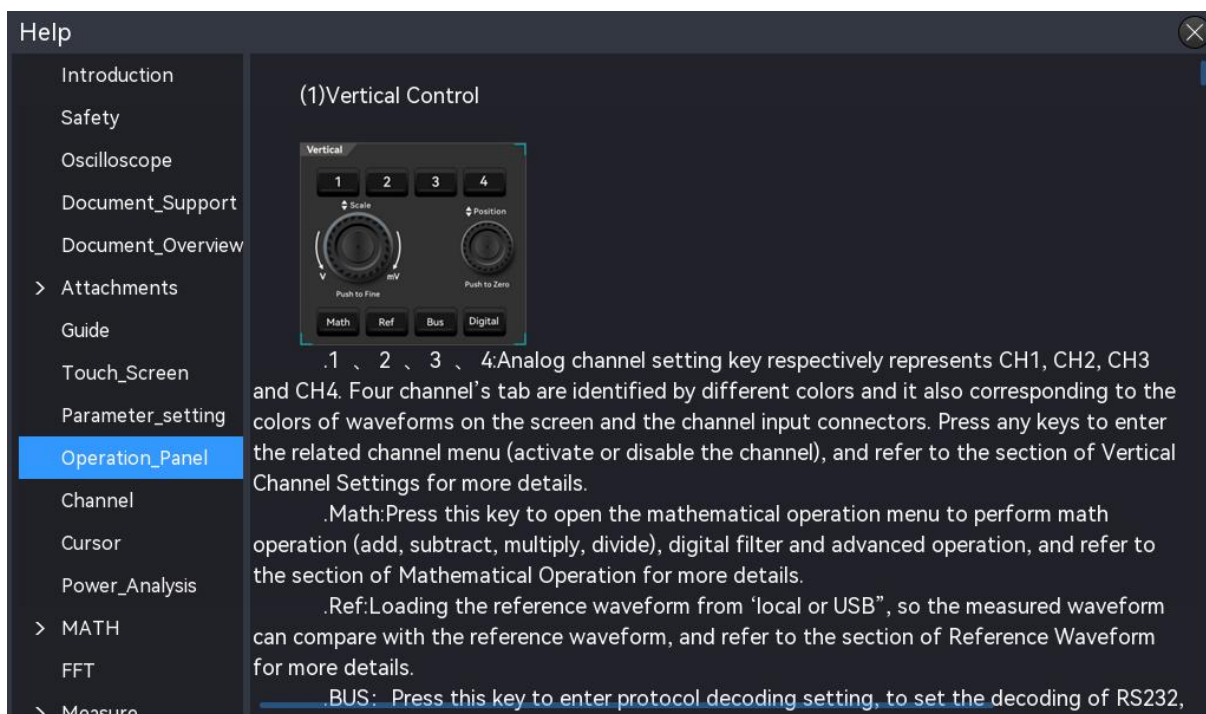

The screenshot shows the 'Help' application window. On the left is a sidebar titled 'Help Options' with a list of categories: Introduction, Safety, Oscilloscope, Document_Support, Document_Overview, > Attachments, Guide, Touch_Screen, Parameter_setting, **Operation_Panel** (highlighted in blue), Channel, Cursor, Power_Analysis, > MATH, FFT, > Measure. The main area is titled '(1)Vertical Control' and contains a screenshot of the 'Vertical' control panel from the oscilloscope. This panel has four tabs labeled 1, 2, 3, and 4. Below the tabs are two knobs: 'Scale' (with a 'V' label) and 'Position' (with a 'mV' label). Below the knobs are four buttons: 'Math', 'Ref', 'Bus', and 'Digital'. Below the screenshot, there is explanatory text:

.1、2、3、4: Analog channel setting key respectively represents CH1, CH2, CH3 and CH4. Four channel's tab are identified by different colors and it also corresponding to the colors of waveforms on the screen and the channel input connectors. Press any keys to enter the related channel menu (activate or disable the channel), and refer to the section of Vertical Channel Settings for more details.

.Math: Press this key to open the mathematical operation menu to perform math operation (add, subtract, multiply, divide), digital filter and advanced operation, and refer to the section of Mathematical Operation for more details.

.Ref: Loading the reference waveform from 'local or USB', so the measured waveform can compare with the reference waveform, and refer to the section of Reference Waveform for more details.

.BUS: Press this key to enter protocol decoding setting, to set the decoding of RS232,

31. Notification Setting

Click on the notification area at the bottom of the screen to enter the time setting and file browser setting.



31.1. Time Setting

Click on the time at the bottom of the screen to open the “Time Setting” pop-up box.

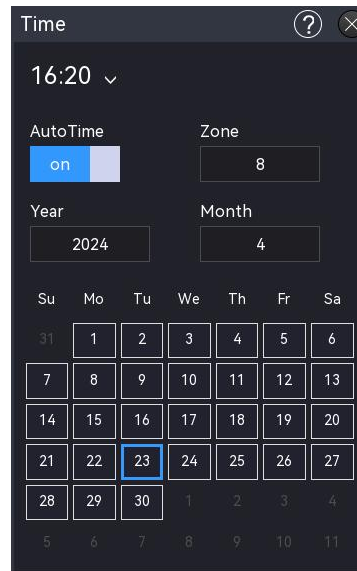

(1) Automatically Set Time

Click on the “Auto Time” to switch on/off the setting. The automatic set time can only be synchronized to Beijing time when the oscilloscope is connected to the network. If it is not connected to the network, the time will be based on the current set time.

(2) Time Zone

Click on the “Time Zone” input field, and rotate the Multipurpose A rotary knob on the front panel to change the time zone. Alternatively, double-click on the “Time Zone” input field to open the numeric keypad to enter the time zone. For the details on the use of the numeric keypad, refer to the section of [5.8 Parameter Setting](#). The time zone can be set from -11 to 12.

(3) Month

Click on the “Month” input field, and rotate the Multipurpose A rotary knob on the front panel to change the month. Alternatively, double-click on the “Month” input field to open the numeric

keypad to enter the month. For the details on the use of the numeric keypad, refer to the section of [5.8 Parameter Setting](#). The time zone can be set from 1 to 12.

(4) Year

Click to select the “Year” input field, then rotate the Multipurpose knob on the front panel to modify the year value. Alternatively, double-click the “Year” input field to pop up the numeric keyboard to enter the year. For the details on the use of the numeric keyboard, refer to the section of [5.8 Parameter Setting](#). The year can be set from 2000 to 2050.

(5) Date

Click on the “Date” at the bottom of the screen to set the date, the selected date is displayed in blue.

(6) Time

Click on the “Time” to scroll the two dial plates to set the current time or click and scroll the hour (on the left), minute (on the right) to set the current time. Click on the blank area to complete the time setting.

31.2. File Browser

Click on the USB icon at the bottom right to directly enter the file browser. For the details on the use of the file browser, refer to the section of [File Browser](#).

32. Additional Function Key

- [Automatic Setting](#)
- [Run/Stop](#)
- [Clear Setting](#)
- [Factory Setting](#)

32.1. Automatic Setting

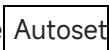
Automatic settings will choose an appropriate time base scale, amplitude scale and trigger parameter according to the input signal so that the waveform will automatically display on the screen. Press the  key on the front panel to enable automatic settings.

Automatic setting only applies to the following conditions.

- a. Automatic setting is only suitable for simple single frequency signals. It is impossible to achieve an effective automatic setting for complex combination waves.
- b. The measured signal frequency is not less than 10 Hz, and the amplitude is not less than 12 mVpp; the duty cycle of square wave is greater than 5%.

32.2. Run/Stop

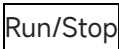
Use the  key on the front panel to set. If the green light is on after the key is pressed, it indicates the RUN state. If the red light is on after the key is pressed, it is the STOP state.

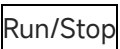
In the running state, the oscilloscope is continuously acquiring waveform and the upper part of the screen shows "AUTO"; in the stop state, the oscilloscope stops the acquisition and the upper part of the screen shows "STOP". Press the  key to switch the waveform sampling between the run and stop states.

32.3. Clear Setting

Press the Clear icon  on the front panel to reset. This will clear all reloaded waveforms and parameter statistics.

32.4. Factory Setting

Press the **Default** key on the front panel, the oscilloscope can quickly restore to the factory setting. The factory settings of MSO1000HD series high-resolution oscilloscopes are listed in the following table.

System	Function	Factory Setting
Vertical System	CH1	200 mV/div
	Vertical offset	0 (Vertical midpoint)
	Offset	0 (Vertical midpoint)
	Coupling	DC
	Bandwidth limit	Full bandwidth
	Volts/div scale	Coarse tuning
	Probe	1×
	Inverse Phase	OFF
	Unit	V
	CH2, CH3, CH4	OFF
	MATH,FFT, REF, Digital	OFF
Horizontal System	Extension window	OFF
	Fine tuning	Coarse tuning
	Horizontal extension	Center
	Auto roll mode	OFF
	Mode	YT
	Source X-Y	C1-C2
	Horizontal time base	1 μ s/div
	Horizontal offset	0 (Horizontal midpoint)
Trigger System	Trigger type	Edge
	Trigger polarity 1	Rising edge
	Coupling mode	DC
	Level	0 V
	Trigger mode	Auto
	Trigger holdoff	80ns
	Source 1	C1
	Noise suppression	OFF
Sampling system	Acquisition mode	Normal
	Storage depth	Auto
	Interpolation	sinc

Display	Display format	Vector
	Grid display	Full display
	Transparence of pop-up window	50%
	Backlight brightness	50%
	Persistence	Auto
	Stop persistence	Not check
	Temperature color	OFF
	Grid brightness	50%
	Waveform brightness	50%
MATH	Type	Basic operation
	Source A	C1
	Operator	+
	Source B	C1
	Vertical scale	200 mV
	Vertical position	0 V
	Label state	OFF
FFT	FFT window function	Hanning
	FFT unit	dB
	FFT count	8 k
	Waterfall curve	OFF
Measurement	Parameter snapshot	OFF
	Parameter measurement	OFF
	Measurement statistical	OFF
	Voltmeter	OFF
	Counter	OFF
	Indicator	OFF
Bus Decoding	Decoding type	RS232
	Bus state	OFF
	Display format	Hexadecimal
	Event list	OFF
	Bus position	0
	RS232 source	C1
	RS232 polarity	Positive

	RS232 bitrate	100 bps
	RS232 bit width	5 bits
	RS232 bit sequence	LSB
	RS232 stop bit	1 bit
	RS232 parity bit	None
Digital	D7-D0 display	OFF
	D15-D8 display	OFF
	D7-D0 threshold	TTL
	D15-D8 threshold	TTL
	Bit sequence	LSB
	Jitter time	5 ns
Other System	Square wave output	1 kHz
	Synchronized output	Idle
	IP	DHCP
	Language	Current language
	Cursor type	OFF
	Horizontal cursor	Fixed delay
	Synchronized move	OFF
	Automatically set channel	Autoset
	Automatically set sampling	Autoset
	Automatically set trigger	Autoset
	Automatically set signal	Autoset
	Select channel	C1
	RUN/STOP	RUN

33. System Prompt and Troubleshooting

- [System Prompt](#)
- [Troubleshooting](#)

33.1. System Prompt

This chapter describes the system prompts, with detailed explanations provided in the table below.

Touch function locked.	This prompt appears when the touchscreen is locked.
Touch function unlocked.	This prompt appears when the touchscreen is unlocked.
USB flash drive is inserted.	This prompt appears when a USB flash drive is successfully inserted.
USB flash drive is removed.	This prompt appears when a USB flash drive is successfully removed.
Save path:	This prompt appears when waveform, image, setting file, decoding list, or Bode plot list (csv, pdf, html) is successfully saved.
Activation successful	This prompt appears when an option is activated again.
No activation file!	This prompt appears when a USB flash drive is inserted but contains no corresponding activation file.
Autoset is completed.	This prompt appears when Autoset is completed.
Frequency too low, please check!	This prompt appears when no signal is applied during power analysis.
Fine Tuning: On	This prompt appears when fine tuning for volts/div, time base is turned on.
Fine Tuning: Off	This prompt appears when fine tuning for volts/div, time base is turned off.
System upgrade is succussed.	This prompt appears when the system upgrade is succussed.
10 MHz synchronization successful.	This prompt appears when 10 MHz synchronization input is successful.
Automatically adjusting memory depth according to	This prompt appears when setting oscilloscope storage depth while opening FFT.

FFT Points	
Load is succused.	This prompt appears when setting files are successfully loaded.
Creation Successful.	This prompt appears when a folder is successfully created in the file browser.
Please select a file.	This prompt appears when renaming, copying, deleting, importing REF files, loading test templates, loading Bode plot CSV data, or selecting arbitrary waveform with no content selected.
Deletion Successful.	This prompt appears when a file is successfully deleted.
Copy Successful.	This prompt appears when a file is successfully copied.
Renaming Successful.	This prompt appears when a file is successfully renamed.
Paste Successful.	This prompt appears when a file is successfully pasted.
Activated.	This prompt appears when an option is activated.
Function in trial mode; for long-term use, please purchase an activation code!	This prompt appears when using an option during the trial period.
Function not activated; please purchase an activation code!	Function not activated; please purchase an activation code!
Auto-calibration completed.	This prompt appears when auto-calibration is completed.
Auto-calibration exited.	This prompt appears when exiting during the auto-calibration process.
Digital calibration completed.	This prompt appears when digital calibration is completed.
Digital calibration exited.	This prompt appears when exiting during the digital calibration process.
Delete this file?	This prompt appears when prompting to delete a file.
File already exists; do you want to overwrite it?	This prompt appears when saving a file but a file with the same name already exists in the specified path.
Already adjusted to the limit!	This prompt appears when adjustments have reached the limit and cannot be continued. This occurs when adjusting the vertical scale factor, time

	base, horizontal position, vertical position, and trigger level to their limits.
No valid data!	This prompt appears when loading a REF file that contains errors.
This prompt appears when loading a REF file that contains errors.	This prompt appears when opening FFT and entering SCAN or ROLL modes.
AWG channel overloaded; please check the circuit!	This prompt appears when the AWG is overloaded with a power signal.
Analog channel overloaded; please check the circuit!	This prompt appears when analog channels C1 - C4 are overloaded with a power signal.
This prompt appears when analog channels C1 - C4 are overloaded with a power signal.	This prompt appears when input exceeds the maximum length in the letter or number keyboard.
10 MHz synchronization clock input not detected!	This prompt appears when the 10 MHz synchronization signal is not connected.
Digital probe not inserted!	This prompt appears when the digital probe is not connected, and the digital display is opened.
Signal source not opened; please open it and try again!	This prompt appears when the signal source is not opened during waveform saving operations.
USB drive not inserted!	This prompt appears when the USB drive is not connected for option activation or full activation operations.
This prompt appears when the USB drive is not connected for option activation or full activation operations.	This prompt appears when the USB drive is not connected for option activation or full activation operations.
The current fundamental wave does not support the selected modulation; switching to a supported fundamental wave!	This prompt appears when a non-supported modulation fundamental wave is selected in continuous wave mode.
Too many parameters; please delete measurement items first!	This prompt appears when 27 custom parameters are added in Measure, and an attempt is made to add more.
Digital probe inserted!	Digital probe inserted!
Digital probe removed!	This prompt appears when the digital probe is disconnected.
This function is not supported	This prompt appears when attempting to record

in average sampling mode!	waveforms in average sampling mode.
Input channel has no signal!	This prompt appears when there is no signal connected during the Autoset operation.
Waveform recording function is not supported in the current mode!	This prompt appears when attempting to record waveforms in ROLL/SCAN mode.
This operation is prohibited during waveform recording!	This prompt appears when attempting to modify time base settings, vertical position, open FFT, open XY, or expand windows during waveform recording.
Time base setting is not in the recommended range; bandwidth limitation may be inaccurate!	This prompt appears when adjusting time base settings for custom bandwidth.
Disk is full.	This prompt appears when there is insufficient disk space to continue saving content.
Expression error.	This prompt appears when there is an error in mathematical expressions input for advanced calculations.
Upgrade failed.	Upgrade failed.
Fundamental wave type error.	This prompt appears when an unsupported fundamental wave type is selected for amplitude modulation, frequency modulation, amplitude shift keying, frequency shift keying, or sweeping.
Loading failed.	This prompt appears when loading a template fails during testing.
Paste failed.	This prompt appears when the copied file has been deleted and a paste operation is attempted.
Directory does not exist.	This prompt appears when the corresponding file cannot be found in the import file path due to the directory being deleted.
No upgrade file.	This prompt appears when there is no upgrade file available for the upgrade operation.
Incorrect password.	This prompt appears when using the wrong password to connect to Wi-Fi.
Parameter error.	This prompt appears when Gen parameters are set to their limit values during channel copy operations.
Invalid address.	This prompt appears when manually setting the IP address, subnet mask, or gateway incorrectly.
Connection successful.	This prompt appears when the Wi-Fi connection is

	successful.
Connection failed.	This prompt appears when the Wi-Fi connection fails.
File name is empty.	This prompt appears when there is no content entered in the file name input box.
Please pause before saving the waveform in ROLL/SCAN mode!	This prompt appears when attempting to save a waveform in ROLL/SCAN mode.
Already at the latest version!	Already at the latest version!
Incorrect upgrade package!	This prompt appears when an incorrect upgrade file is selected for the upgrade process.
Please use the navigation in Stop mode!	This prompt appears when entering the navigation function while in Run mode.

33.2. Troubleshooting

- (1) If the oscilloscope remains on a black screen without any display when pressing the power soft key.
 - a. Check if the power plug is properly connected and the power supply is normal.
 - b. Check if the power switch is turned on. If the power switch is turned on, the power soft key on the front panel should be green. When the power soft key is enabled, the power soft key should be blue, and the oscilloscope will make an active sound. There should be a normal relay rattle when the soft switch key is pressed.
 - c. If the relay has sound, it indicates that the oscilloscope is normal boot-up. Press the Default key and press the “Yes” key, if the oscilloscope returns to normal, indicating that the backlight brightness is set too low.
 - d. Restart the oscilloscope after completing the above steps.
 - e. If the product still does not work properly, contact the UNI-T Service Center for assistance.
- (2) After signal acquisition, the waveform of the signal does not appear on the screen.
 - a. Check whether probe and DUT are connected properly.
 - b. Check whether the signal output channel is open.
 - c. Check whether the signal connecting line is connected to analog channel.
 - d. Check whether the signal source has DC offset.
 - e. Plug out the connected signal, to check whether the base line is within the screen range (if not, please perform self-calibration).

- f. If the product still does not work properly, contact the UNI-T Service Center for assistance.
- (3) The measured voltage amplitude value is 10 times larger or 10 times smaller than the actual value.

Check whether the channel probe attenuation ratio settings are consistent with the used probe attenuation rate.

- (4) There is a waveform display but not stable.
- a. Check the trigger settings in trigger menu whether is consistent with the actual signal input channel.
 - b. Check the trigger type: the general signals should use "Edge" trigger. The waveform can only be displayed stably if the trigger mode is set correctly.
 - c. Try to change trigger coupling to HF rejection or LF rejection, to filter out the high-frequency or low-frequency noise that interfere with the trigger.
- (5) No waveform is displayed after pressing the **Run/Stop** key.
- a. Check whether the trigger mode is set to "Normal" or "Single" and verify if the trigger level exceeds the waveform range.
 - b. If the trigger mode is normal or single and the trigger level is in the center, set the trigger mode to Auto.
 - c. Press the **Autoset** key to automatically complete the above settings.
- (6) Waveform refresh is very slow.
- a. Check whether the acquisition method is set to "Average" and if the average times are large.
 - b. Check whether the memory depth is maximum
 - c. Check whether the trigger holdoff is large.
 - d. Check whether it is normal trigger and is slow time base.
 - e. All the above will lead to slow waveform refresh, it is recommended to restore the factory settings, then the waveform can be refreshed normally.

34. Appendix

34.1. Appendix A Maintenance and Cleaning

(1) General Maintenance

Keep the instrument away from the direct sunlight.

Caution: Keep sprays, liquids and solvents away from the instrument or probe to avoid damaging the instrument or probe.

(2) Cleaning

Check the instrument and probe frequently according to the operating condition. Follow these steps to clean the external surface of the instrument:

- a. Please use a soft cloth to wipe the dust outside the instrument.
- b. When cleaning the LCD screen, please pay attention and protect the transparent LCD screen.
- c. When cleaning the dust screen, use a screwdriver to remove the screws of the dust cover and then remove the dust screen. After cleaning, install the dust screen in sequence.
- d. Please disconnect the power supply, then wipe the instrument with a damp but not dripping soft cloth. Do not use any abrasive chemical cleaning agent on the instrument or probes.

Warning: Please confirm that the instrument is completely dry before use, to avoid electrical shorts or even personal injury caused by moisture.

34.2. Appendix B Built-in Arbitrary Wave Table

Type	Name	Description
Common function (15)	AbsSine	Absolute sine wave
	AbsSineHalf	Absolute half-sine wave
	AmpALT	Amplify sine wave
	AttALT	Attenuates sine wave
	Gaussian_monopulse	Gaussian monocycle
	GaussPulse	Gaussian pulse
	NegRamp	Falling ramp
	NPulse	N-Pulse signal
	PPulse	P-Pulse signal
	SineTra	TraSine wave signal
	SineVer	VerSine wave signal
	StairUD	Stair up and down
	StairDn	Stair down
	StairUp	Stair up
	Trapezia	Trapezoid
Engine (25)	BandLimited	Band limited signal
	BlaseiWave	Vibration of blasting "time-vibration velocity" curve
	Butterworth	Butterworth filter
	Chebyshev1	Chebyshev filter I
	Chebyshev2	Chebyshev filter II
	Combin	Combined function
	CPulse	C-Pulse signal
	CWPulse	CW pulse signal
	DampedOsc	Damped oscillation "time-offset" curve
	DualTone	Double audio signal
	Gamma	Gamma signal
	GateVibar	Gate self-oscillation signal
	LFMPulse	Linear FM pulse signal
	MCNoise	Mechanical noise
	Discharge	Ni-MH battery discharge curve
Pahcur	Brushless DC motor current wave	

	Quake	Quake wave
	Radar	Radar signal
	Ripple	Power ripple
	RoundHalf	Half round wave
	RoundsPM	RoundsPM wave
	StepResp	Step response signal
	SwingOsc	Swing oscillation - time curve
	TV	Television signal
	Voice	Voice signal
Maths (27)	Airy	Airy function
	Besselj	Besselj function I
	Besselk	Besselk function
	Bessely	Besselj function II
	Cauchy	Cauchy distribution
	Cubic	Cubic function
	Dirichlet	Dirichlet function
	Erf	Error function
	Erfc	Complementary error function
	ErfcInv	Inverse complementary error function
	ErfInv	Inverse error function
	ExpFall	Exponential falling function
	ExpRise	Exponential rising function
	Gammaln	Natural logarithm of Gamma function
	Gauss	Gaussian distribution (Normal distribution)
	HaverSine	Haversed sine
	Laguerre	Quartic Laguerre polynomial
	Laplace	Laplace distribution
	Legend	Quintic Legendre Polynomials
	Log10	Logarithm function based on 10
	LogNormal	Logarithmic normal distribution
	Lorentz	Lorentzian function
	Maxwell	Maxwell distribution
	Rayleigh	Rayleigh distribution
Versiera	Versiera	

	Weibull	Weibull distribution
	ARB_X2	Square function
SectMod (5)	AM	Sine wave amplitude modulation
	FM	Sine wave frequency modulation
	PFM	Pulse wave modulation
	PM	Sine wave phase modulation
	PWM	Pulse width modulation
Bioelect (6)	Cardiac	Electrocardio signal
	EOG	Electro-oculogram
	EEG	Electroencephalogram
	EMG	Electromyography
	Pulseilogram	Sphygmus curve of common people
	ResSpeed	Expiration rate curve of common people
Medical (4)	LFPulse	Low frequency pulse electrotherapy waveform
	Tens1	Transcutaneous electric nerve stimulation waveform 1
	Tens2	Transcutaneous electric nerve stimulation waveform 2
	Tens3	Transcutaneous electric nerve stimulation waveform 3
Automotive (17)	Ignition	Ignition waveform of automobile internal-combustion engine
	ISO16750-2 SP	Profile map of automobile starting oscillation
	ISO16750-2 Starting1	Automobile starting voltage waveform 1
	ISO16750-2 Starting2	Automobile starting voltage waveform 2
	ISO16750-2 Starting3	Automobile starting voltage waveform 3
	ISO16750-2 Starting4	Automobile starting voltage waveform 4
	ISO16750-2 VR	Operating voltage profile map of automobile under resetting
	ISO7637-2 TP1	Transient phenomena of automobile caused by power cut

	ISO7637-2 TP2A	Transient phenomena of automobile caused by inductance in wiring
	ISO7637-2 TP2B	Transient phenomena of automobile caused by turning off start-up changer
	ISO7637-2 TP3A	Transient phenomena of automobile caused by conversion
	ISO7637-2 TP3B	Transient phenomena of automobile caused by conversion
	ISO7637-2 TP4	Working profile map of automobile under start-up
	ISO7637-2 TP5A	Transient phenomena of automobile caused by power cut of battery
	ISO7637-2 TP5B	Transient phenomena of automobile caused by power cut of battery
	SCR	SCR (sintering temperature distribution)
	Surge	Surge signal
Trigonome (21)	CosH	Hyperbolic cosine
	CosInt	Cosine integral
	Cot	Cotangent function
	CotHCon	Concave hyperbolic cotangent
	CotHPro	Convex hyperbolic cotangent
	CscCon	Concave cosine
	CscPro	Convex cosine
	CotH	Hyperbolic cotangent
	CscHCon	Concave hyperbolic cosecant
	CscHPro	Convex hyperbolic cosecant
	RecipCon	Reciprocal of the depression
	RecipPro	Reciprocal of the projection
	SecCon	The secant of the depression
	SecPro	The secant of the projection
	SecH	Hyperbolic secant
	Sinc	Sinc function
	SinH	Cotangent function
SinInt	Sine integral	
Sqrt	Square root function	

	Tan	Tangent function
	TanH	Hyperbolic tangent
AntiTrigonome (16)	ACosH	Arc-cosine function
	ACotCon	Arc- hyperbolic cosine function
	ACotPro	Arc- hyperbolic cosine function
	ACotHCon	Convex arc cotangent function
	ACotHPro	Concave arc- hyperbolic cosine function
	ACscCon	Convex arc- hyperbolic cosine function
	ACscPro	Concave arc cosecant function
	ACscHCon	Convex arc cosecant function
	ACscHPro	Concave arc hyperbolic cosecant function
	ASecCon	Convex arc hyperbolic cosecant function
	ASecPro	Concave arc secant function
	ASecH	Convex arc secant function
	ASin	Arc hyperbolic secant function
	ASinH	Arcsin function
	ATan	Arc hyperbolic sine function
	ATanH	Arctan function
Noise (6)	NoiseBlue	Blue noise
	NoiseBrown	Brown noise (red noise)
	NoiseGray	Gray noise
	NoisePink	Pink noise
	NoisePurple	Purple noise
	Noisewhite	White noise
Window function (17)	Bartlett	Bartlett window
	BarthannWin	Amended Bartlett window
	Blackman	Blackman window
	BlackmanH	BlackmanH window
	BohmanWin	Bohman window
	Boxcar	Rectangle window
	ChebWin	Chebyshev window
	GaussWin	Gaussian window

	FlatTopWin	Flat-top window
	Hamming	Hamming window
	Hanning	Hanning window
	Kaiser	Kaiser window
	NuttallWin	The minimum of four Blackman Harris window
	ParzenWin	Parzen window
	TaylorWin	Taylor window
	Triang	Quarter window (Fejer window)
	TukeyWin	Tukey window
Complex Wavelets (7)	Complex Frequency B-spline	Complex Frequency B-spline function
	Complex Gaussian	Complex Gaussian function
	Complex Morlet	Complex Morlet wavelet
	Complex Shannon	Complex Shannon function
	Mexican hat	Mexican hat wavelet
	Meyer	Meyer wavelet
	Morlet	Morlet wavelet
Other (34)	ABA_1_1	
	ABA_1_2	
	ALT_03	
	ALT_04	
	ALT_05	
	AUDIO	
	COIL_2_1	
	COIL_2_2	
	DC_04	
	ECT_1_2	
	EGR_2	
	EGR_3_2	
	EST_03_2	
	IAC_1_1	
	INJ_1_1	
	INJ_2	
INJ_3		
INJ_4		

	INJ_5_6	
	INJ_7	
	KS_1_1	
	MAF_1_1	
	MAF_1_2	
	MAF_5_3	
	MAP_1_1	
	MAP_1_2	
	MC_3	
	Mexican hat	Mexican hat wavelet
	O2PROPA1	
	O2PROPA2	
	O2SNAP	
	STAR02_1	
	TPS_1_1	
	TPS_1_2	