

HIOKI

Instruction Manual

LR8400-20

LR8401-20

LR8402-20

MEMORY HiLOGGER

HIOKI E. E. CORPORATION

July 2014 Revised edition 7 LR8400B980-07 14-07H



600301687

HiLogger Firmware Version Information and Upgrades

LAN communication is available with HiLogger firmware version 1.20 and later.
(The release date for version 1.20 is June, 2010.)

The HiLogger firmware version is displayed at the upper right on the System screen.

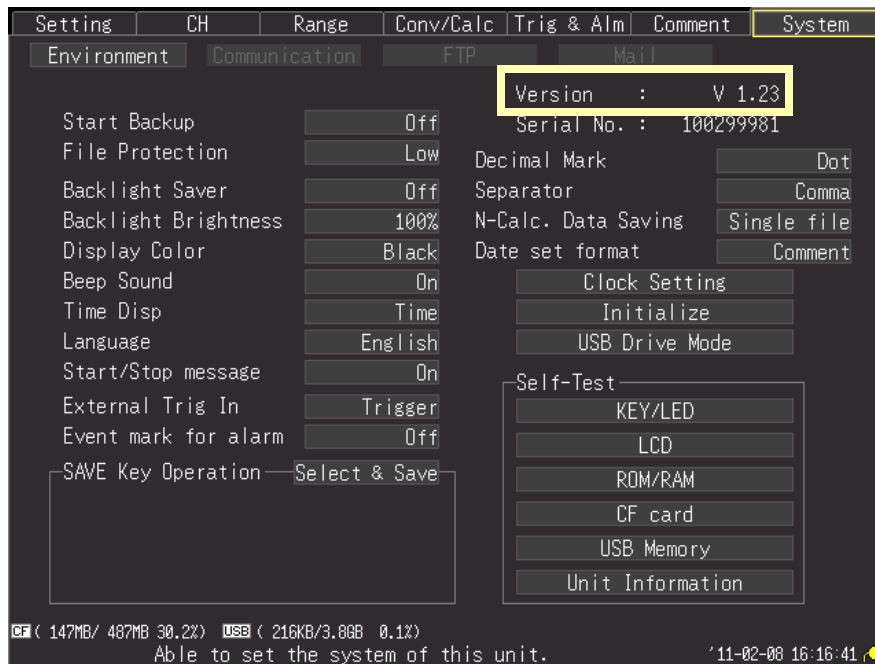

The latest version can be downloaded from Hioki's website.

Please visit our company's website or contact your dealer or Hioki representative for the version upgrade procedure.



Contents

Introduction1
Confirming Package Contents2
Safety Information3
Operating Precautions6

Chapter 1

Overview 13

1.1 Product Overview and Features13
1.2 Measurement Flow 14
1.3 Names and Functions of Parts, Screen Configurations16
1.4 Basic Operation22

- Screen Operations (changing settings, scrolling waveforms, and displaying values) 22
- Starting and Stopping Measurement 23
- Disabling Key Operations (Key-Lock Function) 25
- Performing Zero Adjustment 25
- Saving Data 25
- Confirming Inputs (Monitor) 26

Chapter 2

Measurement Preparations 27

2.1 Attaching Expansion Input Units (as needed)28
2.2 Using the Battery Pack (Option)30

- Install the Battery Pack 30
- Charge the Battery Pack 31

2.3 Connecting the AC Adapter32
2.4 Making Connections33

- Pre-Connection Inspection 33
- Voltage and Thermocouple Temperature Measurement .34
- Temperature Measurement with a Resistance Temperature Detector (RTD) 36
- Humidity Measurement 37
- Resistance Measurement 39
- Pulse Measurement 40



■ Connecting Alarm Outputs	41
■ +12 V Output Connection (for external sensors)	42
■ External Control (using TRIG OUT and EXT TRIG)	43
2.5 Turning the Power On and Off	44
2.6 Inserting a CF Card or USB Flash Drive	
(when saving data)	45
■ CF Card Insertion & Removal	46
■ USB flash drive Insertion & Removal	46
■ Formatting a CF Card/USB flash drive	47
2.7 Compensating for Input Circuit Offset	
(Zero Adjustment)	48

Chapter 3

Settings _____ 49

3.1 Setting Flow Overview	49
3.2 Configuring Measurement Settings	50
■ Time Setting by Key Operations	50
3.3 Input Channel Settings	53
■ Key Setting Procedure	53
■ Voltage Measurement Settings	55
■ Temperature Measurement Settings (using thermocouples)	56
■ Temperature Measurement Settings (for RTDs)	58
■ Humidity Measurement Settings	59
■ Resistance Measurement Settings	60
■ Pulse or Logic Measurement Settings	61
■ Integration (Count) Measurement Settings	62
■ Revolution Measurement Settings	63
3.4 Data Saving Settings	64
3.5 Waveform Display Settings (as needed)	65
■ Key Setting Procedure	65
■ Selecting Waveform Display Color	65
■ Specifying Vertical Display Range by Magnification and	
Zero Position (vertical axis expansion/compression)	66
■ Specifying the Vertical Display Range by Upper and	
Lower Limits (expansion/compression)	67
■ Setting the Display Time Base	
(horizontal axis magnification)	68
3.6 Scaling Settings (as needed)	69

3.7	Entering Titles and Comments (as needed)	71
3.8	Suppressing Noise (Enable Digital Filtering)	73
3.9	Viewing and Editing with the All-Channel Settings List	74
■	Batch Copying Channel Settings	75
■	Batch Setting Waveform Display/Hide and Waveform Color Settings for All Channels	76
■	Initializing Settings (to factory defaults)	77
■	Aligning Zero Positions on the Grid	78
■	Setting CH1 of UNIT1 Value as a Scaling Value (Inter-Channel Compensation function)	79
Chapter 4		
Observing Measurements and Data _____		83
4.1	Confirming Measured Values, and Starting Measurement	83
4.2	Observing Waveforms	85
■	Displaying Waveforms (Display Descriptions)	85
■	Displaying Gauges	86
■	Viewing Input Signals as Numerical Values	87
■	Scrolling Waveforms	88
■	Verifying Waveform Display Position	88
■	Magnifying and Compressing Horizontally	89
■	Viewing Any Waveform Location (Jump Function)	89
■	Specifying a Waveform Time Span	90
■	Displaying Cursor Values	91
4.3	Marking Waveforms and Searching Marks (Search Function)	93
■	Inserting Event Marks While Viewing Waveforms	93
■	Inserting Event Marks Using External Input Signals	94
■	Alarm Event Marks	95
■	How are event marks handled in text (CSV) conversion?	96
■	Searching Event Marks	97
Chapter 5		
Specifying Criteria for Measurements _____		99
■	About Triggering	99
5.1	Triggering Measurement Start and Stop	100

2

3

4

5

- Types of Trigger Criteria 100
- Enable the Trigger Function 101
- Key Setting Procedure 101
- Setting Trigger Criteria 102
- Selecting Triggering Criteria (Trigger Source) 105
- Using External Triggering 106
- Setting Criteria for Pre-Trigger Measuring (Pre-Trig) 108
- 5.2 Alarm Output 109**
 - Checking Alarm Criteria 109
 - Alarm Settings 111
- 5.3 Confirming All Trigger and Alarm Criteria Settings 114**
- 5.4 Periodic (Timer) Measurements 115**
- 5.5 Measurement with Trigger and Timer Functions 117**
- 5.6 Trigger Setting Examples 119**

Chapter 6

Saving & Loading Data 121

- 6.1 About Saving and Loading Data 121**
 - What happens to data in a power outage? 123
 - Preparation for power outages during long-term measurements 123
- 6.2 Saving Data 124**
 - Automatic Saving (Waveform Data and Numerical Calculation Results) 125
 - Replacing Removable Storage During Real-Time Saving . 127
 - Saving Manually (Waveform Data, Screen Images, Numerical Calculation Results) 128
 - To Save a Setting Configuration 131
- 6.3 Loading Data on the HiLogger 132**
 - Loading a Setting Configuration 132
 - Loading Waveform Data and Screen Images 134
- 6.4 Data Management 135**
 - Switching removable storage 135
 - Viewing Folder Contents and the Parent Folder 135
 - Deleting Data 136
 - Renaming Files and Folders 137
 - Copying Data 138
 - Sorting Files 139

6.5 Transferring Data to a PC (USB Drive Mode)	140
■ Select the USB Drive Mode	140
■ Connecting the USB Cable	141

Chapter 7 Numerical Calculations/Waveform Calculations

143

7.1 Calculate Average, Maximum, Minimum, and Etc. .	143
■ Key Setting Procedure	144
■ Real-Time Calculation While Measuring (Auto Calculation)	144
■ Calculation after Measuring (Manual Calculation)	146
■ Apply Calculations to a Specific Time Span (Manual Calculation Only)	147
7.2 Numerical Value Calculation Expressions	148
7.3 Waveform Calculations	149
■ Key Setting Procedure	149

Chapter 8 System Environment Settings

151

■ Key Setting Procedure	152
8.1 Operation Settings	152
■ Using the Auto-Resume Function (Resume After Power Restoration)	152
■ File Protection Level Setting	153
8.2 Screen Key Operation Settings	153
■ Enabling and Disabling the Backlight Saver	153
■ Adjust Backlight Brightness	154
■ Selecting Black or White Screen Background	154
■ Enabling or Disabling the Beeper	154
■ Selecting the Horizontal (Time) Axis Display	155
■ Selecting the Display Language	155
■ Display of Start/Stop Confirmation Messages	155
8.3 CSV File Saving Settings	156
■ CSV File Data Decimal and Separator Characters	156
■ Select the sort order for numerical calculation results ...	156
■ Setting How to Handle Date Data Stored in CSV Files ..	157
8.4 External Trigger Input Settings	157
■ Selecting the External Trigger Function	157

5

6

7

8

■ Set Alarm Event Marking	157
8.5 Making System Settings	158
■ Setting the Date and Time	158
■ Initializing the HiLogger (System Reset)	159
■ Self-Test	160
Chapter 9	
External Control _____	161
9.1 External Trigger Input	161
9.2 External Signal Output (Trigger Output)	162
9.3 Alarm Signal Output (Alarm Output)	163
9.4 Synchronous Measurements with Multiple HiLoggers	164
Chapter 10	
Connection to a PC(Communication) ____	165
■ Communication Features	165
10.1 USB Settings and Connections	166
■ 1. HiLogger Setting	166
■ 2. Installing the USB Driver	167
■ 3. Connecting the HiLogger to a PC	170
■ Features Available After USB Setting and Connection ..	172
■ 4. Installing the Logger Utility Program	173
■ Uninstalling the Logger Utility	177
10.2 LAN Settings and Connections (Before connecting to the network)	178
■ Things to Check Before Making Settings	178
■ 1. PC Network Setup	180
■ 2. HiLogger Settings	181
■ 3. Connecting the HiLogger to a PC	184
■ Features Available After LAN Setting and Connection ..	185
■ When LAN Communication Fails	186
10.3 Using the Logger Utility	187
■ Starting and Ending Logger Utility	187
10.4 Remote Measurement with the HTTP Server Function	188
■ Displaying the Main Page	188

■ Remote Operating	189
■ Start/Stop Measurement	190
■ Viewing Current Measurement Values	190
■ Acquiring Data from Internal Memory	191
■ Setting Comments	192
10.5 Transferring Data to a PC with the FTP Server Function	193
■ Restricting FTP Server Connections (FTP Authentication)	195
10.6 Auto Sending Data using the FTP Client Function	196
■ Setting Up an FTP Server on a PC	197
■ HiLogger Auto-Send Settings	211
■ Testing File Transfer	214
■ Checking Communication Status	215
10.7 Sending E-Mail	216
■ HiLogger E-Mail Settings	217
■ Testing E-Mailing	220
■ Checking Mail Communication Status	221
■ E-Mail Sending Authentication	222
10.8 About Communications Commands	223
■ Configuring Communications Command Operation	223
Chapter 11	
Specifications	225
11.1 LR8400-20, LR8401-20, LR8402-20 Memory HiLogger Specifications	225
11.2 LR8500 Voltage/Temp Unit Specifications	240
11.3 LR8501 Universal Unit Specifications	241
Chapter 12	
Maintenance and Service	243
12.1 Inspection, Repair, and Cleaning	243
12.2 Troubleshooting	244
12.3 Disposing of the HiLogger	246
■ Removing the Lithium Battery	246

8

9

10

11

12

Appendix

Index

Appendix _____ A1

Appendix 1 Scan Timing A1

Appendix 2 Error Messages and Remedial Actions A2

Appendix 3 File Naming A8

Appendix 4 Text File Internal Format A9

Appendix 5 Binary File Size Calculation A10

Appendix 6 List of Default Settings A11

Appendix 7 Maximum Recordable Time A12

Appendix 8 Concerning Noise Countermeasures A13

Appendix 9 Frequently Asked Questions A19

- Installation and Settings A19
- Triggering A21
- Measuring A21
- Data Saving A23
- Logger Utility A25

Appendix 10 Introduction to Measurement Applications A26

- Measuring Electrical Energy by Pulse Count A26
- Connect a 4-20 mA output device and record the average value every minute A28

Appendix 11 Input Circuit Diagram A30

Index _____ Index 1



Introduction

Thank you for purchasing the Hioki Model LR8400-20, LR8401-20, LR8402-20 Memory HiLogger. To obtain maximum performance from the HiLogger, please read this manual first, and keep it handy for future reference.

The following documents are provided with this HiLogger. Refer to them as appropriate for your application. The following documents are provided with this HiLogger. Refer to them as appropriate for your application.

Document	Description
1 Measurement Guide	Read first. Offers an introduction to the HiLogger's basic measuring method for first time users.
2 Instruction Manual (This document)	Contains explanation and instructions regarding the HiLogger's operating method and functions.

Registered Trademarks

- Windows is a registered trademark of Microsoft Corporation in the United States and/or other countries.
- CompactFlash is a registered trademark of Sandisk Corporation (USA).
- Sun, Sun Microsystems, Java, and any logos containing Sun or Java are trademarks or registered trademarks of Sun Microsystems, Inc. in the United States and other countries.

2

Confirming Package Contents

Confirming Package Contents

When you receive the HiLogger, inspect it carefully to ensure that no damage occurred during shipping. In particular, check the accessories, panel switches, and connectors. If damage is evident, or if it fails to operate according to the specifications, contact your dealer or Hioki representative.

Confirm that these contents are provided.

- LR8400-20, LR8401-20, LR8402-20 Memory HiLogger* 1
- Instruction manual (This document) 1

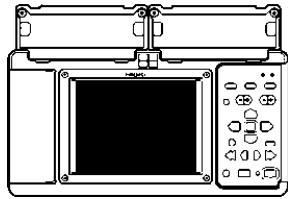

- Measurement guide..... 1



- 9418-15 AC Adapter..... 1
with supplied power cord



(p. 32)

- USB Cable..... 1
(p. 141)

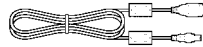

- Logger Utility(Data acquisition application program CD)..... 1



The latest version can be downloaded from our web site.

*: LR8400 (with two Model LR8500 Voltage/Temp Unit)
LR8401 (with two Model LR8501 Universal Unit)
LR8402 (with combined units, and UNIT1 is an LR8501 Universal Unit)

Options

Contact your dealer or Hioki representative for details.

- | | |
|---|---|
| <input type="checkbox"/> LR8500 Voltage/Temp Unit | <input type="checkbox"/> 9727 PC Card (256MB) |
| <input type="checkbox"/> LR8501 Universal Unit | <input type="checkbox"/> 9728 PC Card (512MB) |
| <input type="checkbox"/> Z1000 Battery Pack | <input type="checkbox"/> 9729 PC Card (1GB) |
| <input type="checkbox"/> 9418-15 AC Adapter | <input type="checkbox"/> 9830 PC Card (2GB) |
| <input type="checkbox"/> 9642 LAN Cable | <input type="checkbox"/> C1000 Carrying Case |
| <input type="checkbox"/> Z2000 Humidity Sensor | <input type="checkbox"/> Z5000 Fixed Stand |







Safety Information

⚠ DANGER

This HiLogger is designed to comply with IEC 61010 Safety Standards, and has been thoroughly tested for safety prior to shipment. However, mishandling during use could result in injury or death, as well as damage to the HiLogger. Using the HiLogger in a way not described in this manual may negate the provided safety features. Be certain that you understand the instructions and precautions in the manual before use. We disclaim any responsibility for accidents or injuries not resulting directly from HiLogger defects.

This manual contains information and warnings essential for safe operation of the HiLogger and for maintaining it in safe operating condition. Before using it, be sure to carefully read the following safety precautions.

Safety Symbols

	<p>⚠ In the manual, the ⚠ symbol indicates particularly important information that the user should read before using the HiLogger.</p> <p>The ⚠ symbol printed on the HiLogger indicates that the user should refer to a corresponding topic in the manual (marked with the ⚠ symbol) before using the relevant function.</p>
	Indicates a double-insulated device.
	Indicates a grounding terminal.
	Indicates DC (Direct Current).
	Indicates AC (Alternating Current).
	Indicates the ON side of the power switch.
	Indicates the OFF side of the power switch.



The following symbols in this manual indicate the relative importance of cautions and warnings.

<u>⚠ DANGER</u>	Indicates that incorrect operation presents an extreme hazard that could result in serious injury or death to the user.
<u>⚠ WARNING</u>	Indicates that incorrect operation presents a significant hazard that could result in serious injury or death to the user.
<u>⚠ CAUTION</u>	Indicates that incorrect operation presents a possibility of injury to the user or damage to the HiLogger.
<u>NOTE</u>	Indicates advisory items related to performance or correct operation of the HiLogger.

4

Safety Information

Symbols for Various Standards

	This symbol indicates that the product conforms to regulations set out by the EC Directive.
 Ni-MH	This is a recycle mark established under the Resource Recycling Promotion Law (only for Japan).
	WEEE marking: This symbol indicates that the electrical and electronic appliance is put on the EU market after August 13, 2005, and producers of the Member States are required to display it on the appliance under Article 11.2 of Directive 2002/96/EC (WEEE).

Other Symbols

	Indicates the prohibited action.
(p.)	Indicates the location of reference information.
*	Indicates that descriptive information is provided below.
[]	The names of setting objects and buttons on the screen are indicated by square brackets [].
SET (Bold characters)	Bold characters within the text indicate operating key labels.
<ul style="list-style-type: none">• Unless otherwise specified, "Windows" represents Windows 2000, Windows XP, Windows Vista, or Windows 7.• Dialog box represents a Windows dialog box.• Click: Press and quickly release the left button of the mouse.• Double click: Quickly click the left button of the mouse twice.	

Accuracy

We define measurement tolerances in terms of f.s. (full scale), rdg. (reading) and dgt. (digit) values, with the following meanings:

f.s. (maximum display value or scale length)	The maximum displayable value or scale length. This is usually the name of the currently selected range. Example: For the 1 V range, f.s. = 1 V
rdg. (reading or displayed value)	The value currently being measured and indicated on the measuring instrument.
dgt. (resolution)	The smallest displayable unit on a digital measuring instrument, i.e., the input value that causes the digital display to show a "1" as the least-significant digit.

Measurement categories

This HiLogger complies with CAT II (300 VAC, DC) safety requirements.

To ensure safe operation of measurement instruments, IEC 61010 establishes safety standards for various electrical environments, categorized as CAT II to CAT IV, and called measurement categories.

CAT II:	Primary electrical circuits in equipment connected to an AC electrical outlet by a power cord (portable tools, household appliances, etc.) CAT II covers directly measuring electrical outlet receptacles.
CAT III:	Primary electrical circuits of heavy equipment (fixed installations) connected directly to the distribution panel, and feeders from the distribution panel to outlets.
CAT IV:	The circuit from the service drop to the service entrance, and to the power meter and primary overcurrent protection device (distribution panel).

Using a measurement instrument in an environment designated with a higher-numbered category than that for which the instrument is rated could result in a severe accident, and must be carefully avoided.

Use of a measurement instrument that is not CAT-rated in CAT II to CAT IV measurement applications could result in a severe accident, and must be carefully avoided.

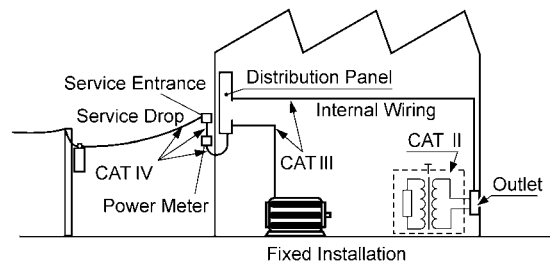

Difference between "Measurement" and "Recording"

The measurement and recording processes are distinguished as follows for the purposes of these instructions.

Measurement:	The acquisition of input values into internal HiLogger memory or to a PC via communications.
Recording :	Storing measurement data on a CF card, USB flash drive or on a PC via data communication.

Measured data (data acquired in internal memory) is erased whenever a new measurement starts. To retain data, always record (save) it.

6

Operating Precautions

Operating Precautions



Follow these precautions to ensure safe operation and to obtain the full benefits of the various functions.

Before Use

- Before using the HiLogger the first time, verify that it operates normally to ensure that no damage occurred during storage or shipping. If you find any damage, contact your dealer or Hioki representative.
- Before using the HiLogger, make sure that the insulation on the cables is undamaged and that no bare conductors are improperly exposed. Using the HiLogger in such conditions could cause an electric shock, so contact your dealer or Hioki representative for replacements.

Instrument Installation

Operating temperature and humidity: 0 to 40°C at 80% RH or less (non-condensating)

Temperature and humidity range for guaranteed accuracy: 23±5°C, 80%RH or less

Avoid the following locations that could cause an accident or damage to the instrument.

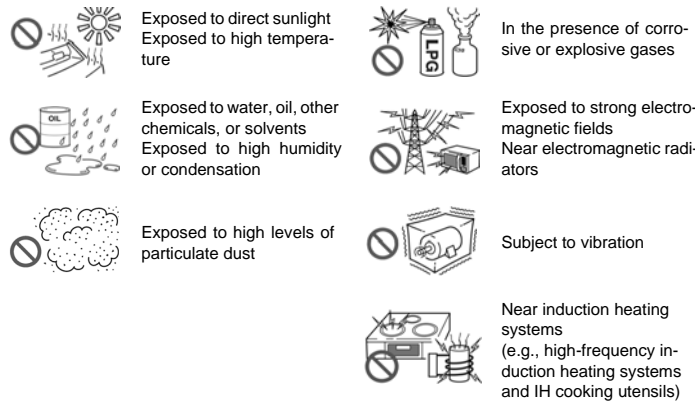

Installation Precautions

NOTE

- Avoid temperature changes around the terminal block. Especially avoid directed airflow such as from an electric fan or air conditioner vent. Thermocouple inputs are prone to measurement errors.
- When the HiLogger is moved to a location with significantly different ambient temperature, allow at least 60 minutes for thermal equalization before measuring.

Handling the Instrument

⚠ DANGER

To avoid electric shock, do not remove the HiLogger's case. The internal components of the HiLogger carry high voltages and may become very hot during operation.

⚠ WARNING

Touching any of the high-voltage points inside the HiLogger is very dangerous.
Do not attempt to modify, disassemble or repair the HiLogger; as fire, electric shock and injury could result.

⚠ CAUTION

To avoid damage to the HiLogger, protect it from physical shock when transporting and handling. Be especially careful to avoid physical shock from dropping.

NOTE

This instrument may cause interference if used in residential areas. Such use must be avoided unless the user takes special measures to reduce electromagnetic emissions to prevent interference to the reception of radio and television broadcasts..

Handling the Cords and Cables

⚠ CAUTION

- Avoid stepping on or pinching cables, which could damage the cable insulation.
- To avoid breaking the cables, do not bend or pull them.
- To avoid damaging the power cord, grasp the plug, not the cord, when unplugging it from the power outlet.

Before Turning Power On

⚠ WARNING

Before turning the HiLogger on, make sure the supply voltage matches that indicated on the AC adapter. Connection to an improper supply voltage may damage the HiLogger or AC adapter and present an electrical hazard.

⚠ CAUTION

When the power is turned off, do not apply voltage or current to the HiLogger. Doing so may damage the HiLogger.

NOTE

- After use, always turn OFF the power.
- Brief power interruptions of 40 ms or less will not cause this HiLogger to malfunction. However, Longer interruptions may cause the HiLogger to shut itself off, so consider local power conditions before installing, as appropriate.
- To ensure that recording is not interrupted by power outages, you can use the 9418-15 AC Adapter and Z1000 Battery Pack together.

8

Operating Precautions

Using the Battery Pack

WARNING

Be sure to observe the following precautions. Incorrect handling may result in liquid leaks, heat generation, ignition, bursting and other hazards.

- Use only the Hioki Model Z1000 Battery Pack. We cannot accept responsibility for accidents or damage related to the use of any other batteries.

See: "2.2 Using the Battery Pack (Option)" (p. 30)

- To avoid the possibility of explosion, do not short circuit, disassemble or incinerate battery pack. When storing the HiLogger, make sure no objects that could short-circuit the connectors are placed near them.
- The battery pack contains lye, which can cause blindness if comes into contact with the eyes. Should battery liquid get into your eyes, do not rub your eyes but rinse them in plenty of water and seek the immediate attention of a physician.
- To avoid electric shock, turn off the power switch and disconnect the cables before replacing the battery pack.
- After installing or replacing the battery pack, replace the battery compartment cover and screw.
- Handle and dispose of batteries in accordance with local regulations.

CAUTION

Observe the following to avoid damage to the HiLogger.

- Use the battery pack in an ambient temperature range of 0 to 40°C and charge it in an ambient temperature range of 10 - 40°C.
- If the battery packs fails to complete charging within the stipulated time, disconnect the AC adapter from the pack to stop charging.
- Consult your dealer or nearest service station should liquid leaks, strange odor, heat, discoloration, deformation and other abnormal conditions occur during use, charging or storage. Should these conditions occur during use or charging, turn off and disconnect the HiLogger immediately.
- Do not expose the HiLogger to water and do not use it in excessively humid locations or locations exposed to rain.
- Do not expose the HiLogger to strong impacts and do not throw it around.

NOTE

- The battery pack is subject to self-discharge. Be sure to charge the battery pack before initial use.
- The battery pack is a consumable. If the battery capacity remains very low after correct recharging, the useful battery life is at an end.
- Battery pack lifetime (to at least 60% initial full-charge capacity) is about 300 charge/discharge cycles.
- To prevent battery pack deterioration when the battery will not be used for 1 month or longer, remove it and store it in a dry location with an ambient temperature range of between -20 to 30°C. Be sure to discharge and charge it every two months. Long-term storage at low battery capacity will reduce performance.
- During battery operation, the HiLogger automatically turns off when battery charge is depleted. Leaving the HiLogger in this state for a long time may cause over-discharge, so be sure to turn the HiLogger's power switch off.
- When the HiLogger has turned off automatically due to low battery charge, turn the power switch off and connect the AC adapter (or install new batteries), then allow about 30 seconds before switching back on. If the HiLogger is turned on too soon, it may turn off again automatically.

Using the AC Adapter**⚠ WARNING**

- **Use only the supplied Model 9418-15 AC Adapter. AC adapter input voltage range is 100 to 240 VAC (with $\pm 10\%$ stability) at 50/60 Hz. To avoid electrical hazards and damage to the HiLogger, do not apply voltage outside of this range.**
- **Turn the HiLogger off before connecting the AC adapter to the HiLogger and to AC power.**
- **To avoid electrical accidents and to maintain the safety specifications of this HiLogger, connect the supplied power cord only to a 3-contact (two-conductor + ground) outlet.**

10

Operating Precautions

Connection Precautions

Connecting to the Analog Input Terminals

⚠ DANGER

Do not leave the HiLogger connected to test objects in environments where a voltage surge might exceed the dielectric withstand voltage. Doing so could result in damage to the HiLogger, bodily injury or fatal accident.

⚠ WARNING

- This instrument is not drip-proof. To prevent liquid including water from entering the instrument, in particular, drop measurement cables down below the instrument.
- To avoid shock and short circuits, turn off the power to lines to be measured before making connections to terminals to be measured and turning on the HiLogger.
- To avoid shock and short circuits, turn off all power before connecting measurement cables.
- Do not connect a cable to the HiLogger while it is connected to the object to be measured. Otherwise, an electric shock accident may occur.
- To avoid short-circuit accidents, make certain that connections are secure.
- To avoid electric shock and short-circuit accidents, always close the analog input terminal cover and tighten the screws.
- To avoid electric shock, use the recommended wire type to connect to the current input terminals, or otherwise ensure that the wire used has sufficient current handling capacity and insulation.
- Channels are insulated by semiconductor relays. When a voltage beyond the specification is applied between the channels, the semiconductor relay may short circuit. Please ensure that a voltage beyond specification, especially a surge such as a lightning, is never applied. When an abnormal measurement value is observed, please contact your dealer or Hioki representative for inspection.

NOTE

- Measurements may be affected by noise or other electromagnetic ingress if input leads are longer than about three meters.
- Route measurement leads and cables as far away as possible from power and earth lines.
- Measurement values may be scattered if the leads are routed in parallel with other devices. If they must be parallel, check operation before taking measurements.

Connecting to the Pulse Input, Alarm Output, and Other External Control Terminals

⚠️ WARNING

- The External Control Terminals is not isolated from the HiLogger's chassis ground. Make certain that there will be no potential difference between the External Control Terminals and the ground of any connected device. Otherwise, the HiLogger or device could be damaged.
- To avoid electric shock or damage to the equipment, always observe the following precautions when connecting to pulse input terminals, alarm output terminals, and External Control Terminals.
- Always turn off the power to the HiLogger and to any devices to be connected before making connections.
- Be careful to avoid exceeding the ratings of External Control Terminals.
- Ensure that devices and systems to be connected to the External Control Terminals are properly isolated.

Using a CF Card/USB flash drive

⚠️ CAUTION

- Inserting a CF card/USB flash drive upside down, backwards or in the wrong direction may damage the CF card, USB flash drive, or HiLogger.
- Never eject a CF card /USB flash drive while measuring or when the HiLogger is or accessing the card. Data on the CF card/USB flash drive may be destroyed. (The CF icon/USB flash drive icon at the lower left is red while the card is being accessed.)
- Do not transport the HiLogger while a USB flash drive is connected. Damage could result.
- As the CF card/USB flash drive is sensitive to static electricity, damage to the CF card/USB flash drive or wrong operations by the HiLogger may occur due to static electricity. Please be careful when handling it.
- With some USB flash drives, the HiLogger may not start up if power is turned on while the USB flash drive is inserted. In such a case, turn power on first, and then insert the USB flash drive. It is recommended to try out operation with a USB flash drive before starting to use it for actual measurements.

NOTE

- The Flash memory in a CF card/USB flash drive has a limited operating life. After long-term usage, data storage and retrieval become difficult. In this case, replace the CF card/USB flash drive with a new one.
- We cannot provide compensation for data loss in a CF card/USB flash drive, regardless of content or cause of the damage. Data is also cleared from memory if a long time passes after measuring. Always maintain a backup of important data stored on a CF card/USB flash drive.
- Although real-time saving to USB flash drive is supported, a CF card is recommended for data preservation. Performance cannot be guaranteed when using storage media other than a Hioki-specified CF card option.

12

Operating Precautions

CD Handling



- Always hold the disc by the edges, so as not to make fingerprints on the disc or scratch the printing.
- Never touch the recorded side of the disc. Do not place the disc directly on anything hard.
- Do not wet the disc with volatile alcohol or water, as there is a possibility of the label printing disappearing.
- To write on the disc label surface, use a spirit-based felt pen. Do not use a ball-point pen or hard-tipped pen, because there is a danger of scratching the surface and corrupting the data. Do not use adhesive labels.
- Do not expose the disc directly to the sun's rays, or keep it in conditions of high temperature or humidity, as there is a danger of warping, with consequent loss of data.
- To remove dirt, dust, or fingerprints from the disc, wipe with a dry cloth, or use a CD cleaner. Always wipe from the inside to the outside, and do no wipe with circular movements. Never use abrasives or solvent cleaners.
- Hioki shall not be held liable for any problems with a PC system that arises from the use of this CD, or for any problem related to the purchase of a Hioki product.

Overview

Chapter 1

1

Chapter 1 Overview

1.1 Product Overview and Features

The portable data logger is expandable from 30 to 60 channels. Data variations can be observed on the high-resolution color LCD screen, and monitored on a PC connected via LAN or USB.

Voltage change, temperature, humidity, and resistance observation
Just connect measurement leads or thermocouples to measure as needed.

Acquire pulse signals
Measure integrated pulses or revolutions from sensors and pulse output devices such as watt-hour meters.

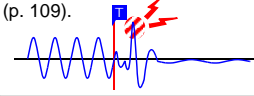

Record anomalies
Abnormal events can be analyzed by recording with the trigger function (p. 99). Use the alarm function to output signals when anomalies occur (p. 109).

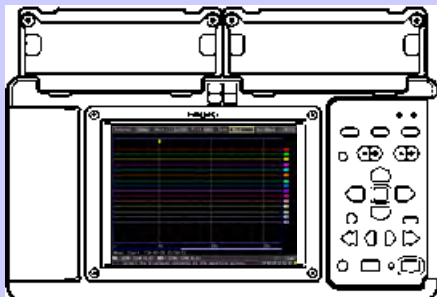

Measurement data and setting configurations are stored, read and managed as data files
Measurement data can be stored to and read from an optional CF card or USB flash drive (p. 121).



Waveform observation

Gauge display (p. 86)	Zoom in/out (p. 89)	Numerical display (p. 87)	Event search (p. 93)
		123.4V	

Observe on a PC
Monitor and analyze measurement data with the supplied application program "Logger Utility" (p. 187).



Cursor Measurements (p. 91)
Using the A/B cursors, values at cursor locations on waveforms and the time at trigger positions can be displayed.



Numerical Calculations (p. 143)
Simultaneously performs six numerical calculation types, including maximum and average values.



Waveform Calculations (p. 149)
Displays on one channel the sum, difference, product, or quotient of values measured on any two analog channels.

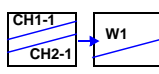

Display in converted units
Using the scaling function, input values can be displayed in units of the actual physical quantity being measured, such as current or flow volume (p. 69).

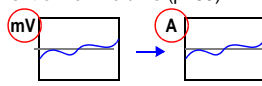

1.2 Measurement Flow

1. Preparations for Measurement (p. 27)

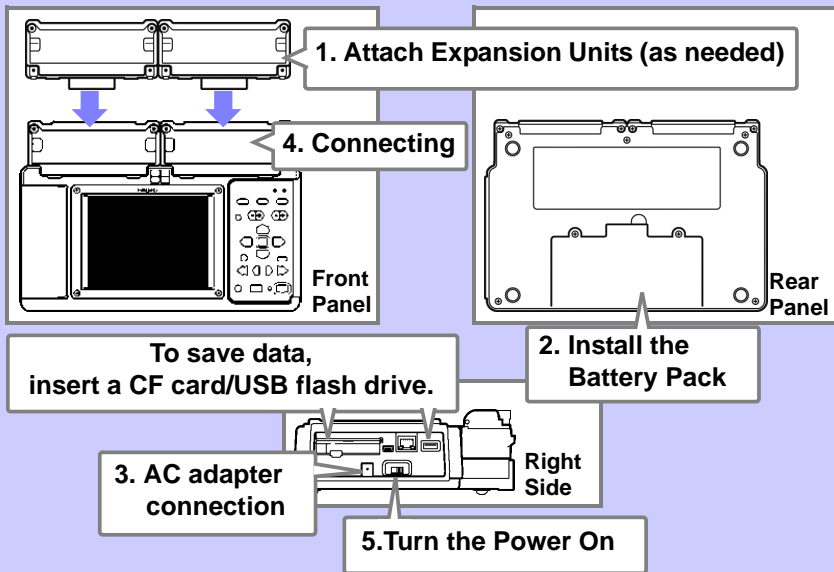

2. Settings (p. 49)

Configure Recording Settings (p. 50)

Setting

Interval 50ms

Record time 0

Auto Save Waveform(realtime)

File Name

Media CF

Deleting Off

Split Save Ref Time 0:0

Split Length 10 min

CF : 3 Day 2 Hour

Timer Off

Move to a setting item

Open the setting options

Select

Apply

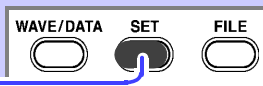

- 1 Set the data acquisition (recording) interval, and recording length (time span).
- 2 Enable auto saving of measured data to removable storage (CF card or USB flash drive) (p. 125).

Data stored in internal memory is lost about 30 minutes after power-off. We recommend auto saving important data to removable storage.

Configure Input Channels (p. 53)

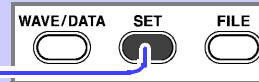

Select input channels, and set input types and measurement ranges.

Make other settings as needed.

- Waveform Display (p. 65)
- Scaling (p. 69)
- Titles and Comments (p. 71)
- Noise Suppression (p. 73)
- View/Edit All-Channel Settings List (p. 74)

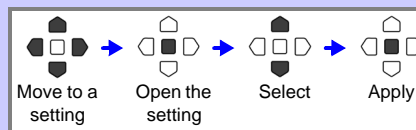

Pre-existing setting configuration data can be loaded from the HiLogger or removable storage (p. 132).

3. Starting and Stopping Measurement (p. 23)

Press the **START / STOP**

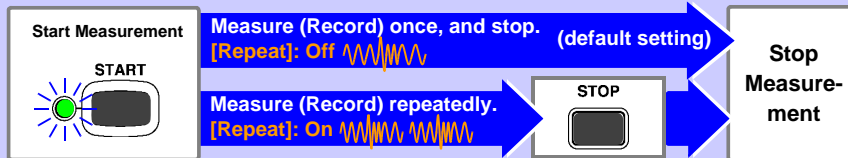

When measuring (recording) using the trigger function (p. 99), measuring occurs only when an input waveform satisfies the specified trigger criteria.

4. Observing Data

- View Measurement Data (p. 83)** ▶ Waveforms can be zoomed and numerical values confirmed.
- Save Data (p. 121)** ▶ Measurement data, waveform data, screen images and numerical calculation results can be saved.
- Calculate (p. 143)** ▶ Numerical measurement data can be applied to calculations.
- View on a PC (p. 187)** ▶ Observe measurement data with the supplied Logger Utility program.

5. When Finished

Turn the HiLogger Off (p. 44)

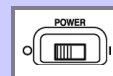

1.3 Names and Functions of Parts, Screen Configurations

Front Panel

Universal Unit*

Use to measure voltage, thermocouple temperature, humidity (with the Hioki Z2000 Humidity Sensor), resistance, and temperature with resistance temperature detectors (RTDs) (p. 33).

Voltage/Temp Unit*

Use to measure voltage, thermocouple temperature, and humidity (with the Hioki Z2000 Humidity Sensor) (p. 33).

External Control Terminals (p. 33)

- Pulse inputs (8 channels)
- Alarm outputs (4 channels)
- External control (one each input, output, and ground channel)
- 12-volt output
- Four alarm channel LEDs indicate alarm events (p. 163)

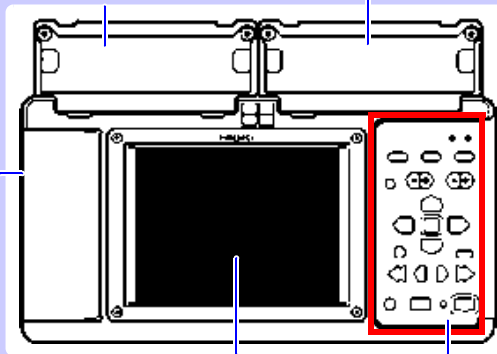

Display Screen (p. 85)

5.7-inch TFT color LCD
Screen Configurations (p. 19)

Operating Keys/LED (p. 17)

* Input units are installed as specified upon factory shipping.

Rear Panel

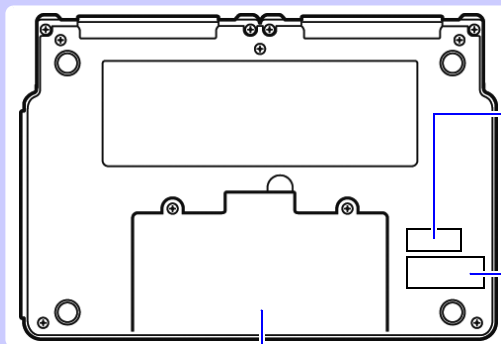

MAC address

Shows the MAC address. Do not remove this label, as it is required for product support.

Serial No.

Shows the serial number. Do not remove this label, as it is required for product support.

Battery Compartment (p. 30)

The optional Model Z1000 Battery Pack is installed here.

Operating Keys/LED

HiLogger Status Indicators

- **POWER**
Lights when powered on (p. 44).
- **CHARGE**
Lights while charging the Z1000 Battery Pack (p. 31).

Setup and display

- **CHAN**
Select channels.
- **UNIT**
Switches input units.
- **MONIT**
Shows the current input waveform and numerical values (data not stored in internal memory).
- **ESC**
Cancels changes to settings.
- **Cursor keys**
Moves the position of the cursor (blinking selection) on the screen.
- **ENTER**
Accepts displayed settings.

The diagram shows the control panel of the LRB400-20 device. At the top, there are two LEDs labeled 'POWER' and 'CHARGE'. Below them are three buttons: 'WAVE/DATA', 'SET', and 'FILE'. The next row contains 'MONIT', 'UNIT', and 'CHAN'. Below these are 'ENTER' and 'KEY LOCK' (with a small 'PRESS 3s' label). The next row has 'ESC' and 'SCROLL CURSOR'. The bottom row features 'SAVE', 'STOP', and 'START' buttons. A central area contains four arrow-shaped cursor keys (up, down, left, right). Blue lines connect these keys and LEDs to their respective descriptions in the surrounding text boxes.

Choose a screen

- **WAVE/DATA**
Selects among Waveform/Numerical screen displays (p. 19).
- **SET**
Displays the Settings screens, and switches among the screen tabs with each press (p. 21).
- **FILE**
Displays file information (p. 20).

Scroll waveforms and read cursor values

- **SCROLL/CURSOR**
Select waveform scrolling or A/B cursor movement.
- **Left and Right Cursor keys**
Scroll waveforms and move A/B cursors (p. 22).

Saving operations

Press to save data manually (p. 124).

Stop measurement

Start measurement

Start and stop measurement. The LED at the left lights green while measuring (p. 23).

Press while measuring to insert event markers in the measurement data. (p. 93)

Right Side

CF Card Slot
Use to save data to a CF card.
Insert an optional CF card (p. 46).

USB Port
Use to save data to a USB flash drive.
Insert an USB flash drive (p. 46).

USB Cable Port (USB 2.0 mini-B receptacle)
Use for PC communications via USB. Connect the supplied USB cable (p. 170).

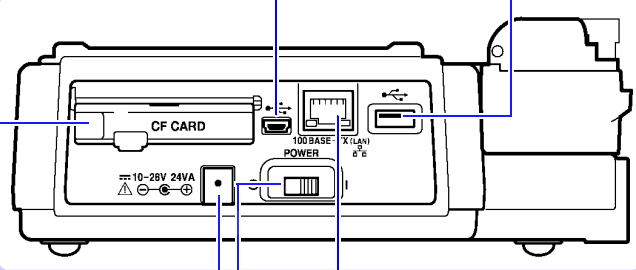

AC Adapter Socket
Connect the supplied Model 9418-15 AC Adapter (p. 32).

POWER Switch
Turns the HiLogger on and off (p. 44).
○ Power Off
| Power On

Ethernet Jack (RJ-45)
Use for PC communications via LAN.
Connect an optional Model 9642 LAN Cable (p. 184).

Waveform/Numerical Screens

WAVE/DATA SET FILE

The screen switches each time you press the key. (7 display types)

[Gauge+Wave] Screen

Measurement data is displayed as waveforms with gauges (p. 86).

[Wave] Screen

Measurement data is displayed as waveforms (p. 85).

[Wave+Value] Screen

Measurement data is displayed as waveforms and numerical values (p. 87).

[Value+Cmnt] Screen

Measurement data is displayed as numerical values with comments (p. 87).

[Value] Screen

Measurement data is displayed as numerical values (p. 87).

[Wave+Crshr] Screen

Measurement data is displayed as waveforms with cursor values (p. 91).

[Wave+Calc] Screen

Measurement data is displayed as waveforms with calculation results (p. 145).

Operational information is displayed along the bottom of the screen.

Screen

Gauge+Wave

Switches among the above screens.

```

    graph TD
      A["[Gauge+Wave]"] --> B["[Wave]"]
      B --> C["[Wave+Value]"]
      C --> D["[Value+Cmnt]"]
      D --> E["[Value]"]
      E --> F["[Wave+Calc]"]
      F --> G["[Wave+Crshr]"]
  
```

UNIT1	Value	Unit
1-1	0.26310	V
1-2	0.26275	V
1-3	0.26305	V
1-4	0.26265	V
1-5	0.26280	V
1-6	0.26240	V
1-7	0.26260	V
1-8	0.26225	V

About the Icons (on all screens)

(Bottom of the screen)

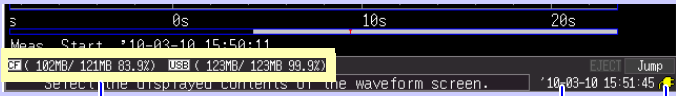





select the displayed contents of the waveform screen.

CF card, USB flash drive
Displayed when a CF card/USB flash drive is inserted. The icon appears red when accessing the CF card/USB flash drive.

Clock
"Setting the Date and Time" (p. 158)

Power source indicator
Indicates the HiLogger's power source.

	AC adapter operation
	Battery pack operation (Fully charged battery pack)
	Battery pack operation
	Battery pack operation (Low battery indicator)

File Screen

WAVE/DATA SET FILE

Operational information is displayed along the bottom of the screen.

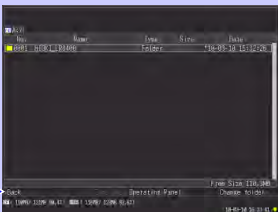

File Screen

View and manage files on the CF card/USB flash drive (p. 134), (p. 135).

1.800.561.8187

www.itm.com

information@itm.com

Settings Screens

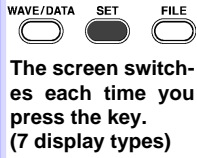

Press the left/right keys to select between the Settings screens.



When a tab is selected with the cursor, press the left/right cursor keys to select between the Settings screens.

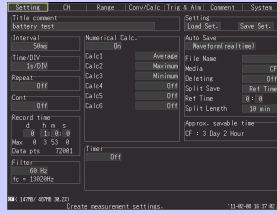

[Setting] Screen

Make settings for recording (p. 50). Set numerical calculation, auto-saving and timers.

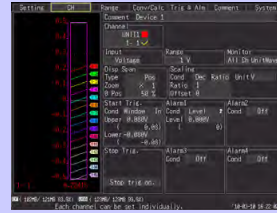

[CH] Screen

Make input channel settings while viewing the monitor display (p. 53).



[Range] Screen

Make settings while viewing all channel settings (p. 74).

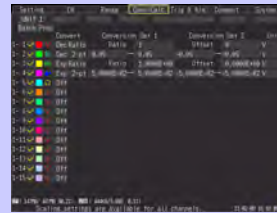

[Conv/Calc] Screen

Make these settings to convert measured values to arbitrary units for display (p.74).



[Trig & Alm] Screen

Recording criteria (triggering) and warning sounds can be set for each channel (p. 99).

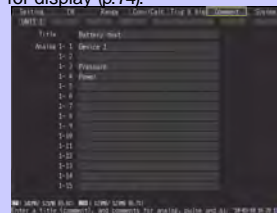

[Comment] Screen

Enter channel comments (p. 71).

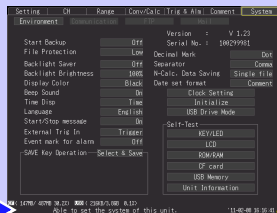

[System] Screen

Operational information is displayed along the bottom of the screen.

Configure the system environment (p. 151).



Selects a measurement input unit and its settings.

1.4 Basic Operation

Screen Operations (changing settings, scrolling waveforms, and displaying values)



Setting Screen



Waveform/Numerical Screen

Changing screen contents

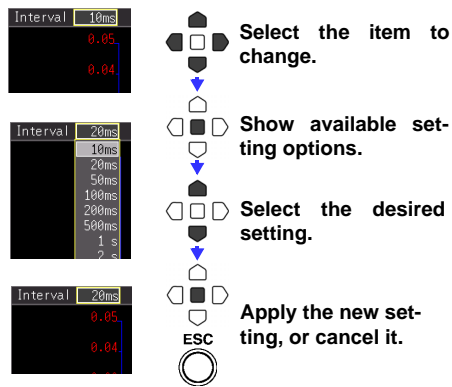

Scrolling a waveform

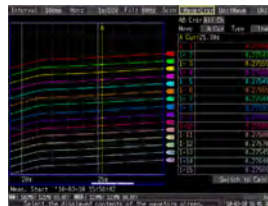
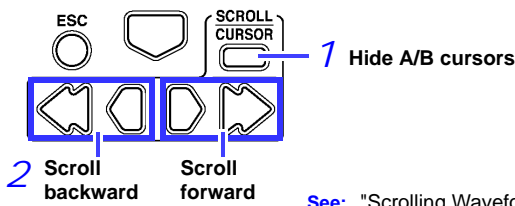

See: "Scrolling Waveforms" (p .88)

Reading values at cursors

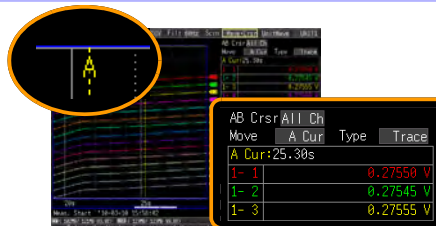
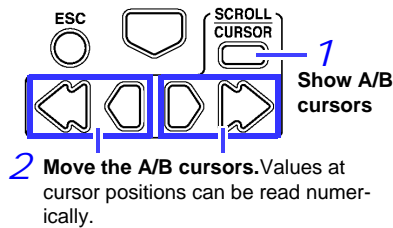

You can select the cursor display type and which cursor(s) to move (p. 91).

Starting and Stopping Measurement

1

Chapter 1 Overview

Start measuring (acquiring measurement data) as follows.

When saving is enabled, data is recorded to the specified removable storage (CF card or USB flash drive) as it is being recorded to internal memory.

Start Measurement

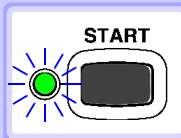

Press **START**.
(The green LED lights.)

Important

If **[Start/Stop message]** is enabled on the System screen, the Start confirmation message appears. Select **[Yes]** to start measurement.

When restarting measurement after stopping, data in the HiLogger's internal memory is overwritten. Be sure to save important data to removable storage before restarting measurement.

Finish Measurement



◆ When **[Repeat]** (record multiple instances of the specified recording length) or **[Cont]** (record continuously) is enabled:

Pressing STOP stops measuring.

◆ When **[Repeat]** and **[Cont]** are disabled (Off):

Measuring stops after the specified recording length.

(If **[Start/Stop message]** is enabled on the System screen, the Stop confirmation message appears when you press **STOP** during measurement. Pressing **STOP** during recording displays a confirmation message. Select **[Yes]** to stop measuring.)

For details about repeating and continuous recording:

See: "Recording Time (Record time)"(p .51), "Repeat Recording (Repeat)"(p .51)

NOTE

To automatically save measurement data, confirm the following before starting:

- Auto saving is properly set (p. 125)
- The removable storage is properly inserted (p. 45)
- There is sufficient free space on the removable storage (p. A12)

About Measuring Operation

See: About Continuous and Repeating Recording: (p. 50)

○ Press **START** ● Press **STOP**

Cont.	Repeat: Off	Repeat: On
Off		
Off (Recording is stopped before one recording length has elapsed)		
On		(Repeat Recording: same as Off)

About Dead time

When repeating recording is enabled ([Repeat] set to [On])

After a recording length has elapsed, some “dead time” is needed for internal processing before recording can resume. No measurement occurs during the dead time. So to avoid information loss, split data into files at a specified interval by enabling continuous recording ([Repeat]), and selecting [Split Save] for auto saving.

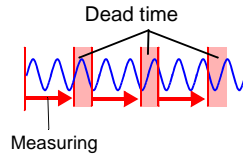

NOTE

Measurement operation depends on whether the trigger or timing function is used (p. 117).

Disabling Key Operations (Key-Lock Function)

1

Keys can be disabled to avoid inadvertent operations.

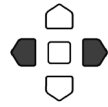

Press and hold the right and left cursor keys for three seconds to lock the other keys, and repeat to unlock.

Performing Zero Adjustment

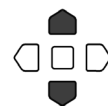

With the Waveform/Numerical or [CH] screen displayed, press the up and down cursor keys simultaneously.

See: "2.7 Compensating for Input Circuit Offset (Zero Adjustment)" (p. 48)

Saving Data

Measurement data, settings, screen images and numerical calculation results can be saved.

For details of the saving methods, see "Chapter 6 Saving & Loading Data" (p. 121).

(Default settings)

Saving Method: [Select & Save] (Press **SAVE** to select and save data.)

Insert a CF card (or USB flash drive).

Press **SAVE.**
(A dialog appears.)

Select the save destination and item to save, and press **ENTER.**

Select **[Yes] in the confirmation dialog, and press **ENTER** again.**
(Data is saved on the selected removable storage.)

Confirming Inputs (Monitor)

You can confirm the status of inputs and display ranges with the current settings (data is not acquired to internal memory).

This function is convenient for checking measured values before activating real-time saving.



Press MONIT.

Unit
Select the input unit for the value display.
Move the cursor to **[UNIT1]**, press **ENTER**, and switch with the up/down cursor or **UNIT**.



Wave
Select to display the waveforms for all channels, or for those on a selected input unit.



UNIT1			
1- 1	0.30195 V	1- 9	0.30150 V
1- 2	0.30205 V	1-10	0.30145 V
1- 3	0.30205 V	1-11	0.30150 V
1- 4	0.30220 V	1-12	0.30150 V
1- 5	0.30225 V	1-13	0.30160 V
1- 6	0.30220 V	1-14	0.30210 V
1- 7	0.30205 V	1-15	0.30160 V
1- 8	0.30180 V		

560KB/ 487MB 0.22) USB (613MB/3.888 15.72)
Select the wave to display. '10-03-12 16:18:27

NOTE

- The monitor function is not available while measuring.
- To display instantaneous values while the HiLogger is measuring, first press **WAVE/DATA** to switch to the **[Wave+Value]** display, then start measurement.
- Depending on the scaling setting, channels requiring more than 14 characters to display the measured value and unit symbols may be displayed in smaller characters.

Measurement Preparations

Chapter 2

2

Chapter 2 Measurement Preparations

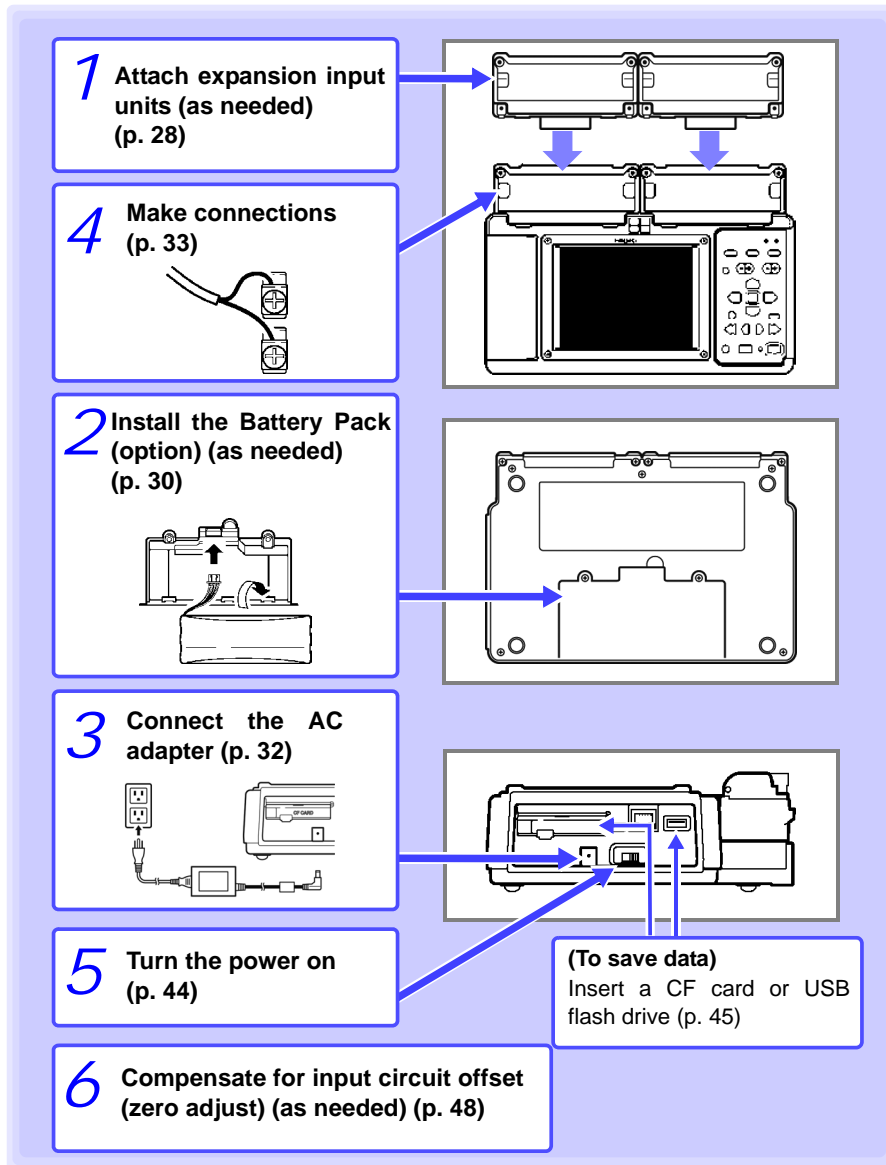

2.1 Attaching Expansion Input Units (as needed)

2.1 Attaching Expansion Input Units (as needed)

Attach optional input units to the HiLogger as needed for the objects to be measured.

Each HiLogger supports up to two additional units.

Input Unit Types

Two types of input units are available.

See "11.2 LR8500 Voltage/Temp Unit Specifications" (p. 240), "11.3 LR8501 Universal Unit Specifications" (p. 241) for detailed input unit specifications.

Input Unit Models

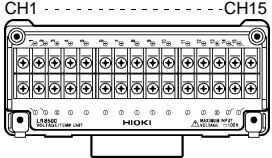
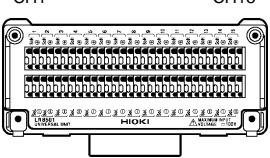
LR8500 Voltage/Temp Unit	LR8501 Universal Unit
<p>Measures voltage, temperature, and humidity</p> <p>Measurement Parameter</p> <ul style="list-style-type: none"> • Voltage • Temperature (thermocouple) • Humidity (using Hioki Z2000 Humidity Sensor) <p>M3 screw terminal block Input channels: 15</p>	<p>Measures voltage, temperature, humidity, and resistance</p> <p>Measurement Parameter</p> <ul style="list-style-type: none"> • Voltage • Temperature (thermocouple or resistance temperature sensor) • Humidity (using Hioki Z2000 Humidity Sensor) • Resistance <p>Push-button terminal block Input channels: 15</p>
<p>CH1 ----- CH15</p> 	<p>CH1 ----- CH15</p> 

Installation Procedure

⚠ WARNING

- To avoid electric shock accidents or damage, turn off the HiLogger and remove the cables before attaching or detaching.
- To avoid electric shock accidents or damage, ensure that the connectors are secured with the screws.
- To avoid electric shock accidents or damage, always attach the cover over the connectors on the HiLogger side and affix with the screws (unless attaching an extension).

NOTE

- The HiLogger can be extended with up to two input units.
- If an input unit is attached when the power is on, it will not be properly recognized.

Required items: extension unit (w/supplied screws), phillips screwdriver (M3)

- 1 Turn the HiLogger off.**
(Disconnect the AC adapter and cables, if connected.)
- 2 Remove the screws from the connector cover on the HiLogger, and remove the cover.**

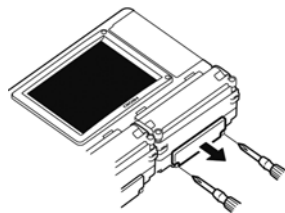

- 3 Remove the screws from the extension input unit and the metal hooks.**

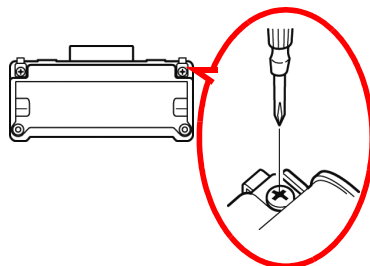

- 4 Align the connectors on the HiLogger and the input unit, mate them together, and secure with the attached screws.**

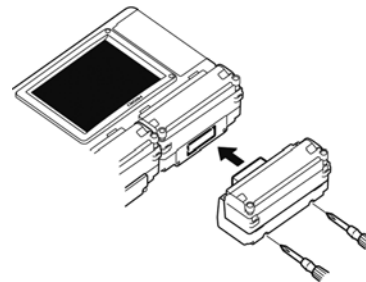

- 5 Mount the extension input unit on the side of the HiLogger with the metal hooks, and tighten the screws securely.**

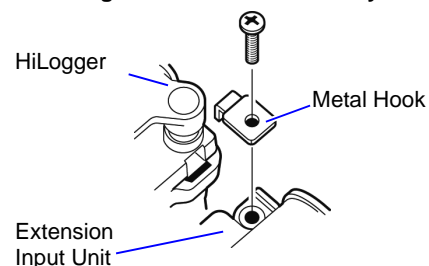

2.2 Using the Battery Pack (Option)



If commercial power is not available when the AC adapter is connected, the LR8400-20, LR8401-20, LR8402-20 Memory HiLogger can operate from the Model Z1000 Battery Pack, so when using commercial power, the battery pack serves as a backup supply during power outages.

Charge the battery pack fully before using it the first time.

Be sure to read "Using the Battery Pack" (p .8) before installing.

Install the Battery Pack

Required items: phillips screwdriver (M3), Hioki Z1000 Battery Pack

- 1 Turn the HiLogger off.**
(Disconnect the AC adapter and cables, if connected.)

- 2 On the back of the HiLogger, loosen the screws affixing the battery compartment cover, and remove it.**

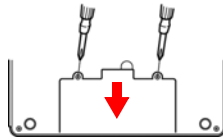

- 3 Connect the plugs of the battery pack to the connectors and insert the battery pack.**

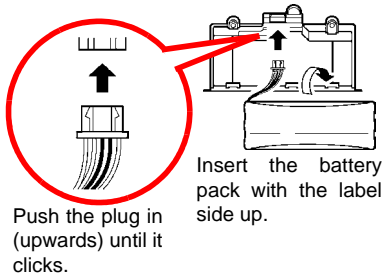

Insert the battery pack with the label side up.

- 4 Tighten the screws in the compartment cover.**

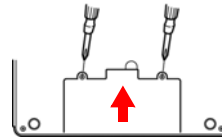

Make sure that the cables are not pinched.

Continuous battery-only operating time is about five hours.

(at 23°C, with fully charged battery, and 25% backlight brightness)

See: "Adjust Backlight Brightness" (p .154)



When installing the battery pack, do not attach the plug to the connector upside down. Doing so will damage the instrument.

Charge the Battery Pack

Regardless of whether the Memory HiLogger is on or off, the battery pack recharges whenever the 9418-15 AC Adapter is plugged in to a power source (p. 32). Therefore, charging is provided by merely keeping the battery installed in the Memory HiLogger.

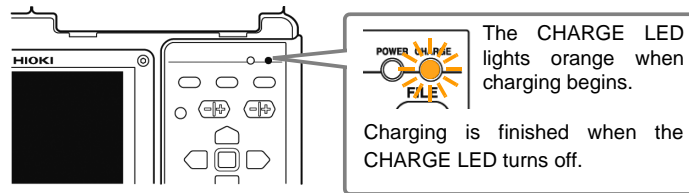

When to charge

When powering the HiLogger from the battery pack without the Model 9418-15 AC Adapter, the low battery indicator () is displayed when the battery charge is depleted, indicating that the battery pack requires charging.

Approximate charging time:

Quick charging a "Low" battery pack takes about three hours.
The Charge LED turns off an hour of additional charging.

2.3 Connecting the AC Adapter



Connect the power cord and the HiLogger to the supplied Model 9418-15 AC Adapter, then plug the power cord into an outlet. When used with the battery pack installed, the battery serves as an operating backup supply in case of power failure, and the AC adapter otherwise has priority.

Before connecting, be sure to read "Using the AC Adapter" (p .9) and "Handling the Cords and Cables" (p .7).

CAUTION

- Connect the output plug to the instrument before plugging the power cord into an outlet. Connecting an energized output plug to the instrument could damage the instrument.
- When connecting an external power supply, connect the output plug to the instrument before activating the external power supply.

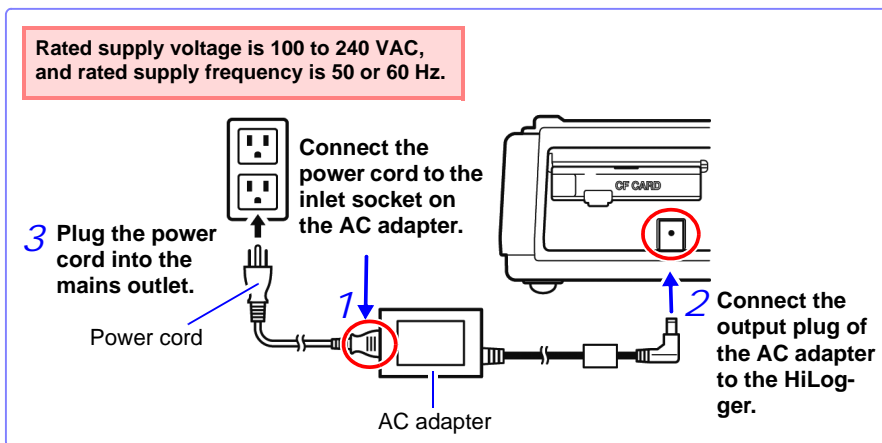

2.4 Making Connections



Pre-Connection Inspection

2

Chapter 2 Measurement Preparations

Before using the HiLogger the first time, verify that it operates normally to ensure that no damage occurred during storage or shipping. If you find any damage, contact your dealer or Hioki representative.

1 Peripheral Device Inspection

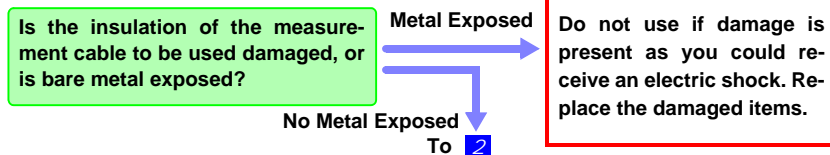

2 Instrument Inspection

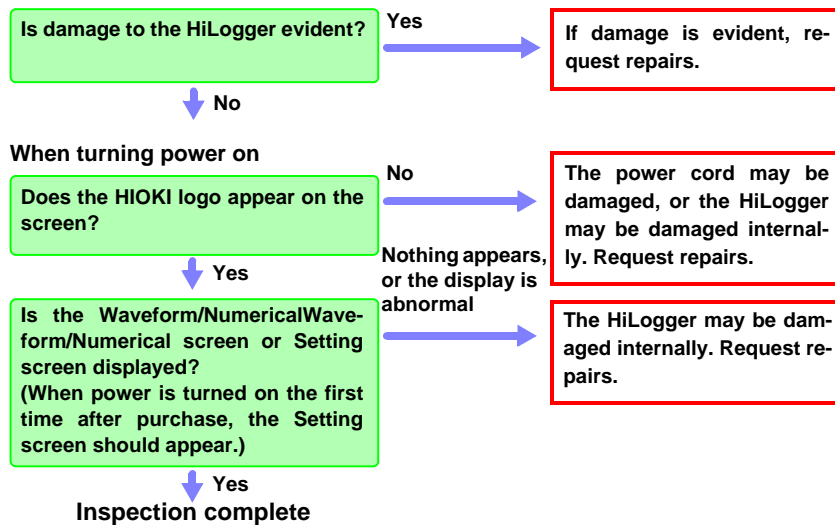

Turn power off before making connections.

Before connecting, be sure to read "Before Use" (p .6), "Handling the Cords and Cables" (p .7), and "Connection Precautions" (p .10).

2.4 Making Connections

NOTE

If connecting crimped terminals to the analog input terminals, use insulated terminals for M3 screws with the size shown below.

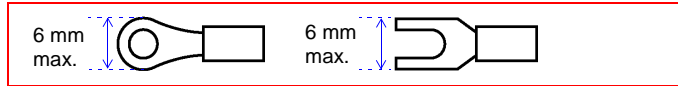

Voltage and Thermocouple Temperature Measurement

< Voltage/Temp Unit >

Required items: phillips screwdriver (for M3 screws), measurement leads (for voltage measurement), or thermocouple (for temperature measurement)

- 1 Loosen the screws in the terminal block cover, and lift the cover.

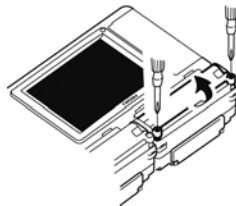

- 2 Loosen the terminal block screws, insert the bare ends of the leads, and tighten the screws.

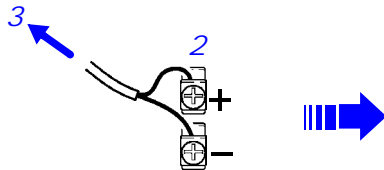

- 3 Connect to the measurement object.

- 4 Replace the terminal block cover, and tighten the screws.

Torque screws to no more than 0.6 N•m.

When measuring instrumentation control equipment (Applying 4 - 20 mA input current)

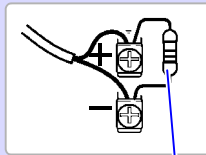

For details on instrumentation control equipment measurements, see (p. 55).

Connect a 250 Ω shunt resistor as shown.

<Connecting to the terminals of the Universal Unit>

Required items: phillips screwdriver (for M3 screws), flat-blade screwdriver (tip width 2.6 mm), measurement leads (for voltage measurement), or thermocouple (for temperature measurement)

Recommended wire diameter: Single strand diameter: $\phi 0.4$ mm - $\phi 1.2$ mm (AWG26-16)
Multi-strand: 0.2 mm² - 0.75 mm² (AWG24-20)
Standard insulation stripping length: 8 mm

2

Chapter 2 Measurement Preparations

- 1** With a Phillips screwdriver, loosen the screws in the terminal block cover, and lift the cover.

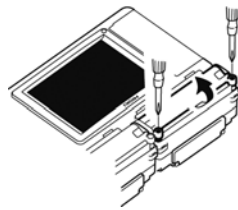

- 2** Push in the button on the connector with a flatblade screwdriver.

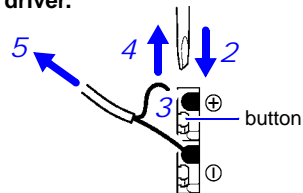

- 3** With the button held in, insert the cable into the cable connection hole.

- 4** Release the button.
The cable is locked.

- 5** Connect to the measurement object.

- 6** Replace the terminal block cover, and tighten the screws.

Torque screws to no more than 0.6 N•m.

Temperature Measurement with a Resistance Temperature Detector (RTD)

<Connecting to the terminals of the Universal Unit>

Required items: phillips screwdriver (for M3 screws), flat-blade screwdriver (tip width 2.6 mm), RTD

Recommended wire diameter: Single strand diameter: $\phi 0.4$ mm - $\phi 1.2$ mm (AWG26-16)

Multi-strand: 0.2 mm² - 0.75 mm² (AWG24-20)

Standard insulation stripping length: 8 mm

- 1** With a Phillips screwdriver, loosen the screws in the terminal block cover, and lift the cover.

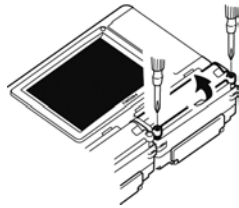

- 2** Push in the button on the connector with a flatblade screwdriver.

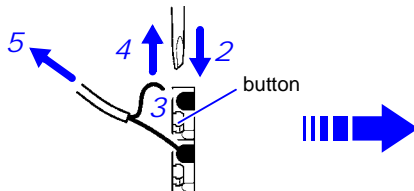

- 3** With the button held in, insert the cable into the cable connection hole.

- 4** Release the button.
The cable is locked.

- 5** Connect to the measurement object.

- 6** Replace the terminal block cover, and tighten the screws.

Torque screws to no more than 0.6 N•m.

3-wire configuration

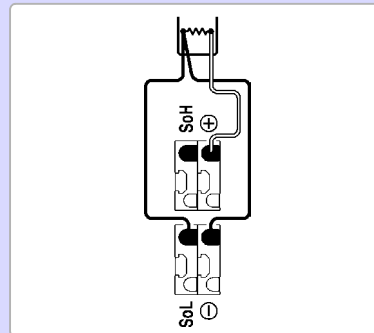

4-wire configuration

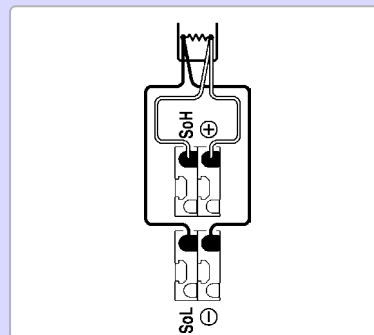

Humidity Measurement

<Connecting to the terminals of the Voltage/Temp Unit>

Required items: phillips screwdriver (for M3 screws), Hioki Z2000 Humidity Sensor

2

Chapter 2 Measurement Preparations

- 1 With a Phillips screwdriver, loosen the screws in the terminal block cover of the Voltage/Temp Unit, and lift the cover.

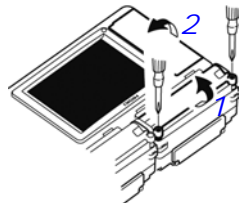

- 2 Pull up the cover on the external control terminal block.

- 3 Loosen the terminal block screws, insert the bare ends of the leads, and tighten the screws.

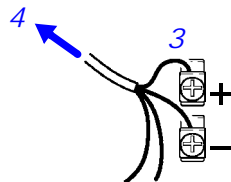

- 4 Connect to the measurement object.

- 5 Replace the terminal block cover on the Voltage/Temp Unit, and tighten the screws.

Torque screws to no more than 0.6 N•m.

- 6 Replace the cover on the external control terminal block.

Connect the wires as follows.

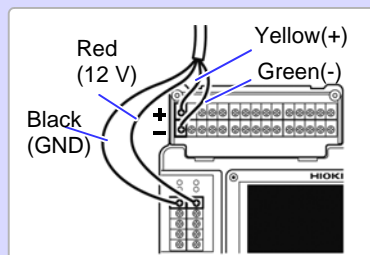

<Connecting to the terminals of the Universal Unit>

Required items: phillips screwdriver (for M3 screws), flat-blade screwdriver (tip width 2.6 mm), Hioki Z2000 Humidity Sensor

- 1** With a Phillips screwdriver, loosen the screws in the terminal block cover of the Universal Unit, and lift the cover.

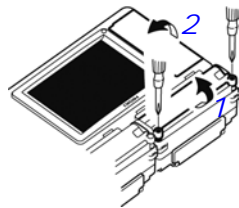

- 2** Pull up the cover on the external control terminal block.

- 3** Loosen the external I/O terminal block screws, insert the bare ends of the leads, and tighten the screws.

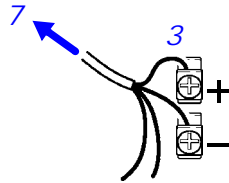

- 4** Push in the button on the universal unit's connector with a flatblade screwdriver.

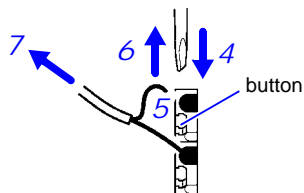

- 5** With the button held in, insert the cable into the cable connection hole.

- 6** Release the button.
The cable is locked.



Connect the wires as follows.

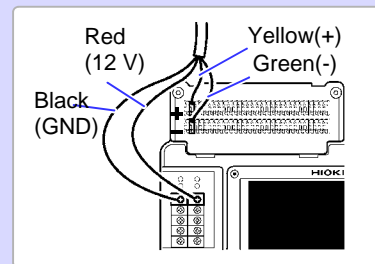

- 7** Connect to the measurement object.

- 8** Replace the terminal block cover on the Universal Unit, and tighten the screws.

Torque screws to no more than 0.6 N•m.

- 9** Replace the cover on the external control terminal block.

Resistance Measurement

<Connecting to the terminals of the Universal Unit>

Required items: phillips screwdriver (for M3 screws), flat-blade screwdriver (tip width 2.6 mm), measurement leads

Recommended wire diameter: Single strand diameter: $\phi 0.4$ mm - $\phi 1.2$ mm (AWG26-16)
Multi-strand: 0.2 mm² - 0.75 mm² (AWG24-20)
Standard insulation stripping length: 8 mm

2

Chapter 2 Measurement Preparations

- 1 With a Phillips screwdriver, loosen the screws in the terminal block cover, and lift the cover.

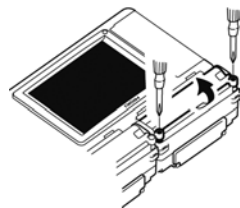

- 2 Push in the button on the connector with a flatblade screwdriver.

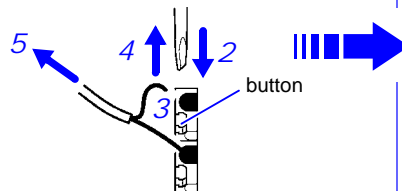

- 3 With the button held in, insert the cable into the cable connection hole.

- 4 Release the button.
The cable is locked.

- 5 Connect to the measurement object.

- 6 Replace the terminal block cover, and tighten the screws.

Torque screws to no more than 0.6 N•m.

4-wire configuration
(2- and 3-wire configurations are not supported)

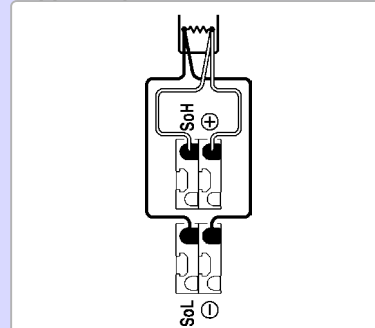

Pulse Measurement

< Connecting to the external control terminals >

Required items: phillips screwdriver (for M3 screws), measurement leads

- 1 Lift the external control terminal block cover.

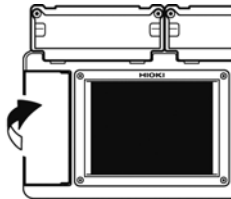

- 2 Loosen the terminal block screws, insert the bare ends of the leads, and tighten the screws.

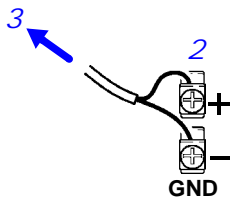

- 3 Connect to the measurement object.

- 4 Replace the cover on the external control terminal block.

Connect the '+' wire to the P1 (or P2 to P8) terminal.
Connect the '-' wire to a GND terminal.

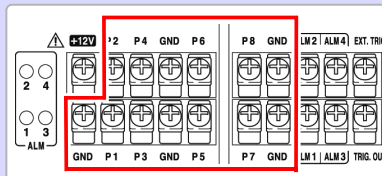

Five GND terminals are provided. Connections can be made to any GND terminal.

Connecting Alarm Outputs

< Connecting to the external control terminals >

Required items: phillips screwdriver (for M3 screws), measurement leads

1 Lift the external control terminal block cover.

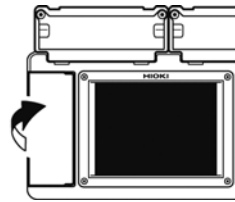

2 Loosen the terminal block screws, insert the bare ends of the leads, and tighten the screws.

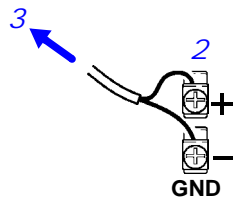

3 Connect to the measurement object.

4 Replace the cover on the external control terminal block.

Connect the '+' wire to the ALM1 (or ALM2 to ALM4) terminal.
Connect the '-' wire to a GND terminal.

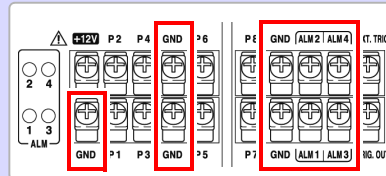

Five GND terminals are provided. Connections can be made to any GND terminal.

+12 V Output Connection (for external sensors)**< Connecting to the external control terminals >**

Required items: phillips screwdriver (for M3 screws), measurement leads

- 1** Lift the external control terminal block cover.

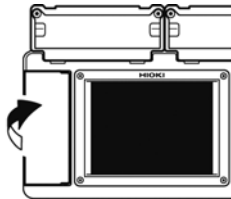

- 2** Loosen the terminal block screws, insert the bare ends of the leads, and tighten the screws.

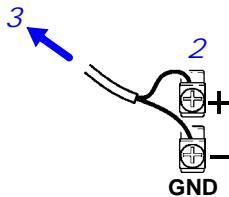

- 3** Connect to the device to be powered, such as an external sensor.

- 4** Replace the cover on the external control terminal block.

Connect the '+' wire to the +12V terminal.

Connect the '-' wire to a GND terminal.

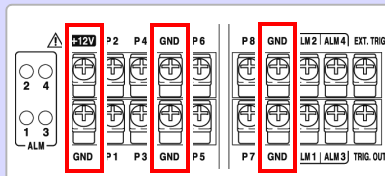

Five GND terminals are provided. Connections can be made to any GND terminal.

CAUTION

+12 V is present whenever the HiLogger is on. When making connections, be careful to avoid short-circuiting to GND terminals.

NOTE

Maximum supply current is 100 mA.

External Control (using TRIG OUT and EXT TRIG)

< Connecting to the external control terminals >

Required items: phillips screwdriver (for M3 screws), measurement leads

1 Lift the external control terminal block cover.

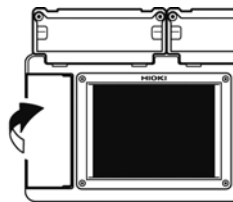

2 Loosen the terminal block screws, insert the bare ends of the leads, and tighten the screws.

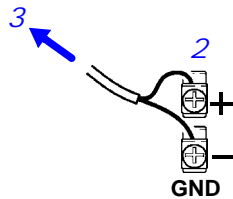

3 Connect the trigger signal input and output.

4 Replace the cover on the external control terminal block.

Connect the '+' wire to the TRIG.OUT (or EXT.TRIG) terminal, and the '-' wire to a GND terminal.

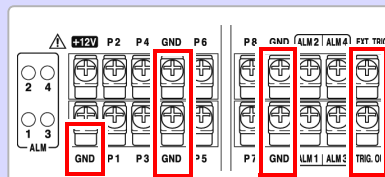

- Connect the TRIG.OUT terminal a trigger input on another device, and connect the EXT.TRIG (input) terminal to the trigger output another device (as needed).
- Five GND terminals are provided. Connections can be made to any GND terminal.

2.5 Turning the Power On and Off

Be sure to read "Before Turning Power On" (p .7) before turning power on.

Turning Power On

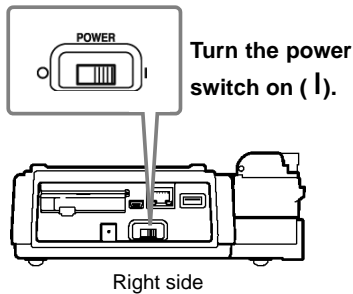

Verify that the HiLogger and peripheral devices are correctly connected.

Initial screen

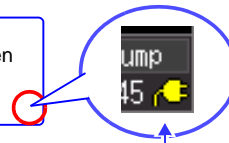

The power supply icon appears near the bottom right corner of the screen (p. 20).

If the "  " indicator is not displayed, the HiLogger is not being powered from the AC line. In this state, the battery charge will be depleted if measuring for a long time, and measurement may be interrupted. Verify that the AC adapter is securely connected to an AC power source and to the HiLogger.

Perform zero adjustment as needed after 30 minutes warm-up (p. 48).

Turning Power Off

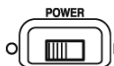

Turn the power switch off (O).

The installed battery pack is charged whenever the AC adapter is plugged into a power outlet, even when the Memory HiLogger is off.

2.6 Inserting a CF Card or USB Flash Drive (when saving data)

To save and reload HiLogger measurement data, use an optional CF card (as described below) or an after-market USB flash drive.

Be sure to read "Using a CF Card/USB flash drive" (p .11) before using removable storage media.

Important

Performance specifications cannot be guaranteed when using storage media other than a Hioki-specified CF card option.

- Hioki options PC cards (includes adapter)
Note: The HiLogger does not support card slot adapters.
9727 PC Card 256M, 9728 PC Card 512M, 9729 PC Card 1G, 9830 PC Card 2G
- See "6.4 Data Management" (p. 135) for details about managing data storage in the media.

CAUTION

If the Eject button is in the released position, press it in first before inserting the CF card all the way in. Inserting the CF card when the Eject button is released may damage the instrument.

If the CF card does not go all the way in, do not force it in. Press the Eject button once to release it, then press it again and insert the CF card all the way in.

NOTE

- Although real-time saving to USB flash drive is possible, a CF card is recommended for optimum real-time data preservation.
- USB flash drive security features such as fingerprint authentication are not supported.

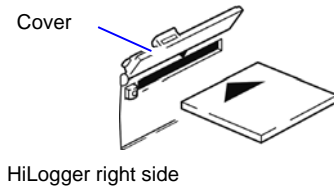
CF Card Insertion & Removal**Inserting a CF card**

- 1 Open the CF card slot cover.
- 2 Press the Eject button in if it is in the released position.
- 3 Face the CF card with the arrow mark on top (▲), and insert it in the direction of the arrow all the way in the slot.

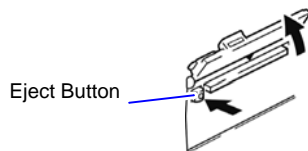
**Removing a CF card**

- 1 Open the CF card slot cover.
- 2 Press the Eject button (to release it).
- 3 Press the Eject button again and pull the card out.

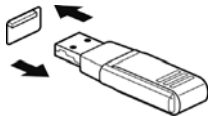
USB flash drive Insertion & Removal**Inserting a USB flash drive**

Align the USB flash drive connector with the USB port, and insert it all the way in.

Removing a USB flash drive

Pull the USB flash drive out.

See: To replace removable storage during real-time saving: (p. 127)

Formatting a CF Card/USB flash drive

The CF card or USB flash drive can be formatted by a PC or by the HiLogger. Format a new CF card or USB flash drive before use.

This procedure describes how to format a CF card or USB flash drive in the HiLogger.

1 **WAVE/DATA** **SET** **FILE**
Select the File Screen.

2 Open the Control Dialog box

3 Select [Format].

Apply
The Format Confirmation dialog appears.

4 Select [Yes].

Apply
The Format Confirmation dialog appears again.

5 Select [Yes].

Apply

NOTE

Formatting irretrievably erases all data on the CF card/USB flash drive. Always backup important data from the CF card/USB flash drive before formatting.

2.7 Compensating for Input Circuit Offset (Zero Adjustment)

Zero adjustment corrects for voltage offset at the input terminals, so that Memory HiLogger measurements are relative to zero volts.

Execute zero adjustment whenever input circuit offset is a concern.

Turn on the power and wait for 30 minutes to stabilize the internal temperature of the HiLogger.

1  Display the Waveform/Numerical screen or [CH] screen

2  Press and hold these keys simultaneously for one second.
(simultaneously) The Zero Adjust dialog appears.

3  Select [Zero Adjust].

 Apply
Zero adjustment is executed.

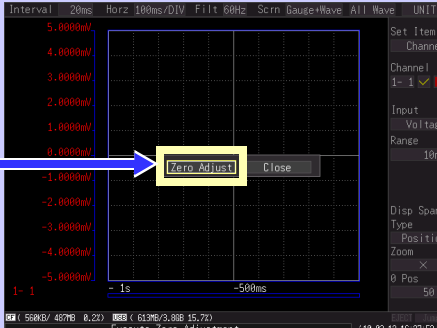

From the Waveform/Numerical screen

NOTE

- Any zero-adjust setting is cleared upon system reset (p. 159).
- Zero adjustment cannot be performed while measuring.

Settings

Chapter 3

3.1 Setting Flow Overview

Configure measurement settings before starting to measure. Select the display method and configure auto saving as needed. After a measurement setting configuration has been saved (p. 131), you can start measuring immediately after loading the setting configuration data.

3

Chapter 3 Settings

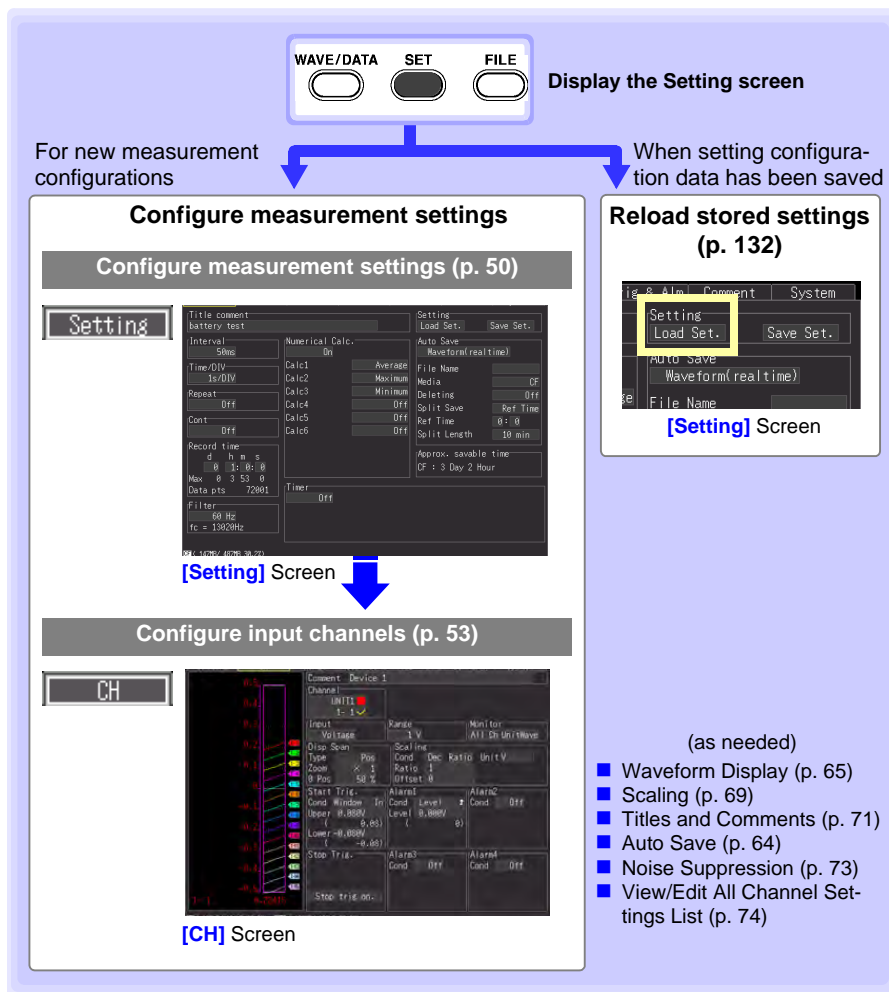

3.2 Configuring Measurement Settings



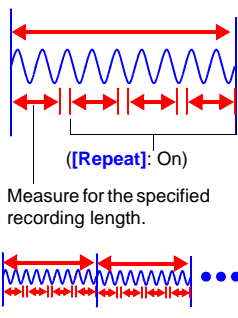

Configure measurement settings on the **[Setting]** screen.
The available measurement methods are **Normal Recording**, **Continuous Recording** and **Repeat Recording**.

NOTE The Setting screen cannot be displayed while measuring.

<p>Start Measurement Stop Measurement</p>  <p style="text-align: center;">((Repeat): On)</p> <p>Measure for the specified recording length.</p>	<p>Continuous Recording Press STOP to stop measuring. Otherwise, measurement continues until the stop-trigger criteria are met.</p> <hr/> <p>Normal Recording Measures for the specified recording time span. Measurement stops when the specified recording time has elapsed. Measurement can also be stopped by pressing STOP before the end of the recording time, or the stop-trigger criteria are met.</p> <hr/> <p>Repeat Recording When stopped by a stop trigger or elapsed recording time, measurement automatically restarts. Press STOP to stop measuring.</p>
--	---

Measuring Method	Setting Method
Normal Recording	Set [Cont] to On.
Continuous Recording	Set [Cont] to Off, and set a [Record time] (measurement time span).
Repeat Recording	Set [Repeat] to On.

Time Setting by Key Operations

- 1  Select the **[Setting]** screen.
- 2  Move to a setting item.
-  Open the setting options for the item to be set.
-  Select from the listed options.
-  Apply

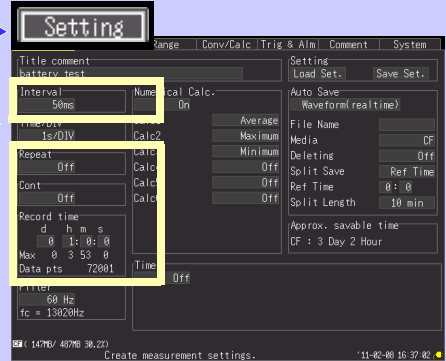

Recording Interval (Interval)

Select the data acquisition interval.

Setting options:(* : default setting)

10ms, 20ms*, 50ms, 100ms, 200ms, 500ms, 1s, 2s, 5s, 10s, 20s, 30s, 1min, 2min, 5min, 10min, 20min, 30min, 1h

- When expansion input units are installed (as UNIT3 and UNIT4), the default setting is 50 ms.
- To select 10-ms intervals, first disable input units 2 to 4 (set to Off).

Repeat Recording (Repeat)

Select whether to automatically start a new measurement after stopping, or to finish after one measurement.

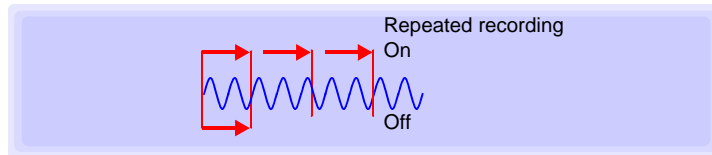

Setting options:(* : default setting)

Off*	Measuring stop after one recording length (time span).
On	When stopped by a stop trigger or elapsed recording time, measurement automatically restarts. Press STOP to stop measuring.

Continuous Recording (Cont)

Select whether to measure for a specified time span, or continuously.

Setting options:(* : default setting)

Off	Normal recording (specify the recording time, and measure)
On*	Select for continuous measurement.

Recording Time (Record time)

Set this when **[Cont]** is disabled (**Off**).

Specify the duration of one recording length (time span).

The maximum setting is limited by the recording capacity of internal memory. The actual limit depends on the selected recording interval and number of channels used for measurements, so the maximum settable time is displayed as the **[Max]** value (indicated by the red box).

The screenshot shows a settings menu with the following fields: 'Cont' (set to Off), 'Record time' (with sub-fields for d, h, m, s), 'Max' (with a red box around the value '0 1 33 12'), and 'Data pts' (set to 51). To the right of the screenshot are navigation icons and labels: 'Change 1's digit' and 'Change 10's digits'. Below the screenshot, the text reads: '**[Max], [Data pts]** To record for a longer time to removable storage device, enable continuous recording. "Maximum Recordable Time" (p .12)

Setting options:(default setting: 10 seconds)

d (0 to 499), h (0 to 23), min (0 to 59), s (0 to 59)

NOTE**About the Recording Interval**

- Select the data acquisition interval to suit your measurement objectives.
- Note that shorter recording intervals restrict the maximum recording time.
- The minimum recording interval depends on the input unit (channels), and whether burn-out detection is enabled.

With burn-out detection (Burn Out) disabled (Off)

When channels 1 to 15 of UNIT1 are selected for measurement: 10 ms
 When channels 1 to 15 of UNIT2 are selected for measurement: 20 ms
 When channels 1 to 15 of UNIT3 and UNIT4 are selected for measurement: 50 ms

With burn-out detection (Burn Out) enabled (On)

When channels 1 to 15 of UNIT1 are selected for measurement: 20 ms
 When channels 1 to 15 of UNIT2 are selected for measurement: 50 ms
 When channels 1 to 15 of UNIT3 and UNIT4 are selected for measurement: 100 ms

See: "Chapter 11 Specifications" (p. 225)

- Some waveform peaks may not be displayable with certain interval settings.
 For example, when the **[Interval]** is 1 s and the **[Time/DIV]** (time base) is 5 s/DIV.

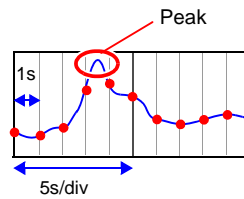

See: About Horizontal Axis Settings: (p. 68)

- With the 50 or 60 Hz digital filter setting, longer recording intervals produce lower cut-off frequencies and better noise suppression (p. 73).
- The recording interval cannot be changed while measuring. Stop measurement before setting.

During Normal Recording ([Cont] disabled (Off), and [Repeat] enabled (On))

After a recording length has elapsed, some "dead time" is needed for internal processing before recording can resume. No measurement occurs during the dead time. So to avoid information loss, split data into files at a specified interval by enabling continuous recording (**[Repeat]**), and selecting **[Split Save]** for auto saving.

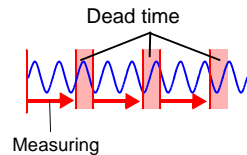

3.3 Input Channel Settings

Configure the input channel settings on the [CH] screen.

NOTE The Setting screen cannot be displayed while measuring.

Input channels are as follows. Each channel can provide the following measurements.

- Voltage/Temp Unit (UNIT1 to UNIT4, each with analog waveform input channels CH1 to CH15)
- Universal Unit (UNIT1 to UNIT4, each with analog waveform input channels CH1 to CH15)
- The HiLogger's external control terminals (pulse/logic waveform inputs P1 to P8)

Application	Channels Used	Reference page
Voltage Measurement	Channels on a Voltage/Temp Unit or Universal Unit	(p. 55)
Temperature Measurement (using thermocouples)		(p. 56)
Humidity Measurement		(p. 59)
Humidity Measurement (using RTDs)	Channels on an Universal Unit	(p. 58)
Resistance Measurement		(p. 60)
Pulse or Logic Measurement	Pulse/logic input channels (HiLogger external control terminals)	(p. 61)
Integration (Count) Measurement		(p. 62)
Revolution Measurement		(p. 63)

Other than these, measurements with specific criteria and alarm outputs are available. See "Chapter 5 Specifying Criteria for Measurements" (p. 99) for details.

Key Setting Procedure

1 Select the [CH] screen.

2 Move to a setting item.

Open the setting options for the item to be set.

Select from the listed options.

Apply

UNIT selects the input unit and **CHAN** select the channel to be set.

3.3 Input Channel Settings

■ Unit Switching

(Analog input channel settings) UNIT1 ••• UNIT4 → (pulse input and alarm output channel settings) PLS & ALM → (numerical calculation channel settings) CALC1 → CALC2 → and return to UNIT1

■ Channel Switching

(Analog input channel settings) 1-1 ••• 1-15 → 2-1 ••• 2-15 → 3-1 ••• 3-15 → 4-1 ••• 4-15 → (pulse input and alarm output channel settings) P1 ••• P8 → ALM1 ••• ALM4 → (waveform calculation channel settings) W1 ••• W30 → and return to 1-1

■ View input status and the display range while making settings on the [CH] screen.

After setting, press **MONIT** to confirm input status and display ranges (p. 26).

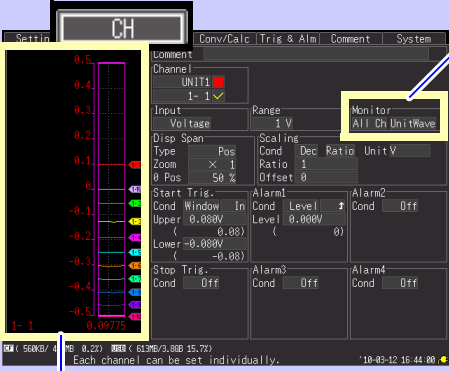

The screenshot shows the 'CH' (Channel) settings screen. On the left, a level monitor displays a waveform with a vertical axis ranging from -0.6 to 0.6. The monitor shows a signal that fluctuates between approximately -0.2 and 0.2. The 'Monitor' dropdown menu is set to 'All Wave'. The right side of the screen contains various settings for the selected channel (UNIT1, 1-1), including input type, range, scaling, and alarm settings.

Monitor display switching
(Right column)

- **[All Wave]**
Displays all channel level monitors.
- **[UnitWave]**
Displays level monitors for all channels in the selected input unit.

(Left column)

- **[All Ch]**
When **[All Wave]** is selected, displays all channel level monitors.
- **[UnitWave]**
When **[UnitWave]** is selected, displays level monitors for all channels in the selected input unit.
- **[SlctCh]**
Displays a channel level monitor for the selected channel.
- **[Value]**
Displays numerical values for all channels in the selected input unit.

Level Monitor
Except when **[Value]** is selected, the gauge is displayed for the currently selected channels. The gauge scale is determined by measurement and display range settings.

Monitoring is not available for disabled (Measurement Off) channels, and those with [X] selected for their color.

NOTE

Level monitor numerical value refresh rate and waveform horizontal axis span depend on the recording interval and horizontal axis (time base) settings. Therefore, long recording intervals can delay numerical value display refresh by as much as 20 seconds. If you need faster value display refresh, select a shorter recording interval. If the horizontal axis (time span) is too long, one division of the waveform may not be displayed.

Voltage Measurement Settings

Configure these settings for each voltage measurement channel.

See: "Key Setting Procedure" (p .53)

1 Select the input unit (**UNIT1 to 4**) and channel (**1-1 to 4-15**), and check the box to enable the channel.

2 Select **[Voltage]**.

3 Select the appropriate measurement amplitude range.

Setting options:(* : default setting)

10mV*, **20mV**, **100mV**, **200mV**, **1V**, **2V**, **10V**, **20V**, **100V**, **1-5V**

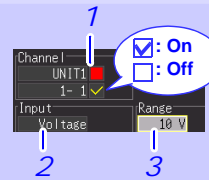

When a measured value far exceeds the range limit (range label)

"OVER" or "-OVER" is displayed in place of numerical/cursor values, and the following values are applied to calculations and data storage.

Input type	Input range	+OVER value	-OVER value
Voltage	10mv	0.0163835	-0.016384
	20mv	0.032767	-0.032768
	100mv	0.163835	-0.16384
	200mv	0.32767	-0.32768
	1V	1.6384	-1.6384
	2V	3.2767	-3.2768
	10V	16.3835	-16.384
	20V	32.767	-32.768
	100V	163.835	-163.84
	1-5V	16.3835	-16.384

Instrumentation and Control Device Measurements

- To measure 4-20 mA current, connect a 250 Ω shunt resistor between + and - analog input terminals (p. 34).
- Select the **[1-5V]** range to measure 4-20 mA instrumentation control signal outputs.
- The **[1-5V]** setting automatically selects the **[10V]** range with an 5-V upper limit and 1-V lower limit. To change the upper and lower limits, select the **[10V]** range.

NOTE

Use the scaling function to scale measurements to any arbitrary unit value for display (p. 69).

Temperature Measurement Settings (using thermocouples)

Follow this procedure to configure thermocouple temperature measurement channels. Make these settings on the [CH] screen.

See: "Key Setting Procedure" (p .53)

1 Select the input unit (**UNIT1 to 4**) and channel (**1-1 to 4-15**), and check the box to enable the channel.

2 Select [Tc].

3 Select the type of thermocouple to be used.

Setting options:(* : default setting)

K*, J, E, T, N, R, S, B, W

4 Select the temperature measurement range.

Setting options:(* : default setting)

100°C, *500°C, 2000°C

The type-B thermocouple setting is disabled when the 100°C or 500°C range is selected. To use a type-B thermocouple, first set the range to 2000°C.

5 Select the reference junction compensation (**RJC**) method.

Setting options:(* : default setting)

INT* Use the HiLogger's internal compensation. Select this when connecting the thermocouple (or compensating leads) directly to the HiLogger. Measurement accuracy is the sum of the temperature measurement accuracy and the RJC accuracy.

EXT Use an external RJC method instead of the HiLogger's internal compensation. Select this when using an external cold junction reference (e.g., ice water). HiLogger measurement accuracy is equivalent to the temperature measurement accuracy.

6 Enable/disable burn-out detection.

Setting options:(* : default setting)

OFF* Disable burn-out detection. Normally when the thermocouple is disconnected, the value will fluctuate, etc. and will not be stable.

ON Detect burn-out during thermocouple measurement. When a burn-out occurs, "BURNOUT" is displayed as the numerical, cursor, or calculation value, and the following values are applied to calculations and data storage: 327.66, 1638.3, and 3276.6°C for the 100, 500, and 2000°C.f.s. ranges, respectively. Note that the recording interval setting is limited.

See: "About the Recording Interval" (p .52)

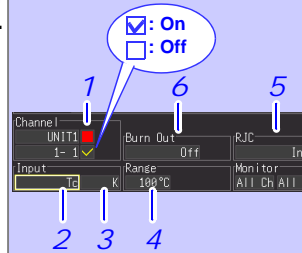

Temperature Measurement Range
(Depends on thermocouple type)

K	-200°C to 1350°C
J	-200°C to 1200°C
E	-200°C to 1000°C
T	-200°C to 400°C
N	-200°C to 1300°C
R	0°C to 1700°C
S	0°C to 1700°C
B	400°C to 1800°C
W	0°C to 2000°C

With type B, the display shows 0 to 400°C, but accuracy is not guaranteed.

About Burn-Out Detection

- When burn-out detection (Burn Out) is enabled (On), a tiny sensing current is applied during each recording interval during thermocouple measurements to detect broken wires.
- Detection current is timed to avoid affecting measured values.
- For a specific recording interval, the filter cut-off frequency is higher when burn-out detection is enabled, so noise suppression is less effective.
See: "Chapter 11 Specifications": "Cut-off frequency" (p .237)
- When measuring the temperature of the range's +f.s., the wire is considered to be broken when the thermocouple resistance exceeds nearly following values. When burn-out detection is enabled with extended thermocouple wires, be sure that the wire diameter is sufficient.

		Range		
		100°Cf.s.	500°Cf.s.	2000°Cf.s.
Thermocouple	K	260	5400	4370
	J	470	4150	1630
	E	1520	7400	390
	T	220	5440	5440
	N	520	1470	590
	R	90	40	880
	S	90	80	1300
	B	–	–	2090
	W	220	910	3090

Unit: Ω

For example, measurement in the 100°C range with a K-type thermocouple and 0.32 mm diameter wire extended beyond about 20 meters is detected as a burn-out.

If Thermocouple Measurement Range is Exceeded, or when a measured value far exceeds the range limit (range label)

- Example: Using a type T thermocouple with range -200 to +400°C
 When a measured value exceeds the measurement range of the thermocouple and far exceeds the range limit (range label), the waveform saturates at the top of the screen, as shown at the right.
- When a measured value far exceeds range limit (range label), "OVER" or "-OVER" is displayed in place of numerical/cursor values, and the following values are applied to calculations and data storage.

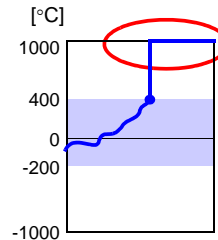

Input type	Input range	+OVER value	-OVER value
Thermocouple (Tc)	100°C	327.67	-327.68
	500°C	1638.4	-1638.4
	2000°C	3276.7	-3276.8

- With burn-out detection enabled, burn-out is detected when measurement input exceeds the range of the thermocouple, and far exceeds the selected measurement range.

3.3 Input Channel Settings

Temperature Measurement Settings (for RTDs)

Follow this procedure to configure resistance temperature detector (RTD) measurement channels. Make these settings on the [CH] screen.

See: "Key Setting Procedure" (p .53)

- 1** Select the input unit (UNIT1 to 4) and channel (1-1 to 4-15), and check the box to enable the channel.
- 2** Select [Rtd].
- 3** Select the type of RTD to be used.
Setting options:(* : default setting)
Pt100*, JPt100
- 4** Select the appropriate temperature measurement range.
Setting options:(* : default setting)
100°C*, 500°C, 2000°C
- 5** Select the wiring configuration.
Setting options:(* : default setting)
3 Wire* 3-wire RTD connection configuration
4 Wire 4-wire RTD connection configuration

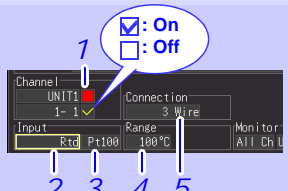

The range setting determines the measurable temperature range

100°C	-100°C to 100°C
500°C	-200°C to 500°C
2000°C	-200°C to 2000°C

Temperature measurement limits are determined by the measurement range selected for each sensor.

Temperature Measurement Ranges
(Temperature measurement range depends on RTD characteristics)

Pt100	-200°C to 800°C
JPt100	-200°C to 500°C

When the RTD measurement range is exceeded, or when a measured value far exceeds the range limit (range label)

- Example: Using a type Pt100 RTD with range -200 to +800°C
When a measured value exceeds the measurement range of the RTD and far exceeds the range limit (range label), the waveform saturates at the top of the screen, as shown at the right.
- When a measured value far exceeds range limit (range label), "OVER" or "-OVER" is displayed in place of numerical/cursor values, and the following values are applied to calculations and data storage.

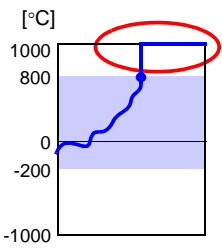

Input type	Input range	+OVER value	-OVER value
RTD	100°C	327.67	-327.68
	500°C	1638.4	-1638.4
	2000°C	3276.7	-3276.8

Humidity Measurement Settings

Enable this channel setting for humidity measurement with the optional Z2000 Humidity Sensor. Make these settings on the [CH] screen.

See: "Key Setting Procedure" (p .53)

- 1 Select the input unit (UNIT1 to 4) and channel (1-1 to 4-15), and check the box to enable the channel.
- 2 Select [Humid].

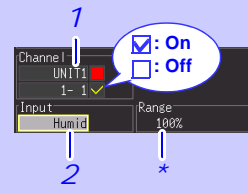

* The range is fixed at [100% f.s.].

When a measured value far exceeds the range limit (range label)

"OVER" or "-OVER" is displayed in place of numerical/cursor values, and the following values are applied to calculations and data storage.

Input type	Input range	+OVER value	-OVER value
Humidity	100%RH	3276.7	-3276.8



Resistance Measurement Settings

Make these channel settings for resistance measurement.

Make these settings on the [CH] screen.

See: "Key Setting Procedure" (p .53)

- 1 Select the input unit (UNIT1 to 4) and channel (1-1 to 4-15), and check the box to enable the channel.
- 2 Select [Resist].
- 3 Select the appropriate measurement amplitude range.
Setting options:(* : default setting)
10Ω*, 20Ω, 100Ω, 200Ω

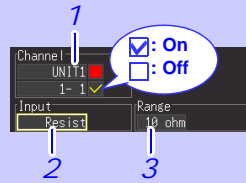

NOTE

For inductive loads such as coil windings, the slow response time may prevent correct resistance measurement. In this case, select a recording time longer than 5 s.

When a measured value far exceeds the range limit (range label)

"OVER" or "-OVER" is displayed in place of numerical/cursor values, and the following values are applied to calculations and data storage.

Input type	Input range	+OVER value	-OVER value
Resistance	10Ω	16.3835	-16.384
	20Ω	32.767	-32.768
	100Ω	163.835	-163.84
	200Ω	327.67	-327.68

Pulse or Logic Measurement Settings

Make these channel settings for pulse and logic measurements.

(See "Integration (Count) Measurement Settings" (p .62) and "Revolution Measurement Settings" (p .63) for pulse measurements.)

Make these settings on the [CH] screen.

See: "Key Setting Procedure" (p .53)

- 1 Select the input unit (PLS&ALM) and channel (P1 to P8), and check the box to enable the channel.

- 2 Select [Logic].

When Logic is selected, the channel display automatically changes from P1 to L1.

- 3 Select the High/Low reference (threshold) values.

Setting options:(* : default setting)

1V*	Judge 1.0 V or higher as HIGH, and 0 to 0.5 V as LOW.
4V	Judge 4.0 V or higher as HIGH, and 0 to 1.5 V as LOW.

- 4 Select a filter setting.

Setting options:(* : default setting)

Off*	Filter is disabled.
On	Filter is enabled. Prevents incorrect counts due to relay contact chatter (noise).

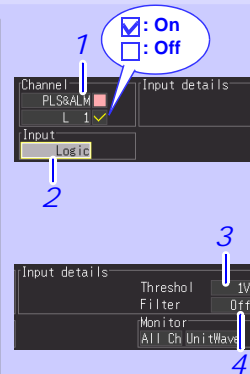

3

Chapter 3 Settings

NOTE

Channels L1 to L8 share the same On/Off state. For example, when L1 and L2 are both enabled, disabling L1 also disables L2. Threshold and filter settings are specific to each channel.

Integration (Count) Measurement Settings

Configure these settings for each pulse channel receiving input from a pulse output device such as a watt-hour or flow meter. Make these settings on the [CH] screen.

See: "Key Setting Procedure" (p .53)

1 Select the input unit (PLS&ALM) and channel (P1 to P8), and check the box to enable the channel.

2 Select [Count].

3 Select the integration mode (Count Mo).

Setting options:(* : default setting)

Add* Counts the number of pulses acquired from the start of measurement.

Inst Counts the number of pulses acquired during each recording interval. The pulse count is reset at the beginning of each recording interval.

4 Select the basis of measurement (Slope).

Setting options:(* : default setting)

↑* Counts the number of L - H transitions.

↓ Counts the number of H - L transitions.

5 Select the High/Low reference (threshold) values.

Setting options:(* : default setting)

1V* Judge 1.0 V or higher as HIGH, and 0 to 0.5 V as LOW.

4V Judge 4.0 V or higher as HIGH, and 0 to 1.5 V as LOW.

6 Select a filter setting.

Setting options:(* : default setting)

Off* Filter is disabled.

On Filter is enabled. Prevents incorrect counts due to relay contact chatter (noise).

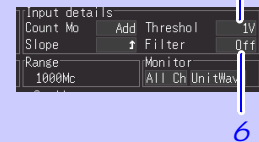
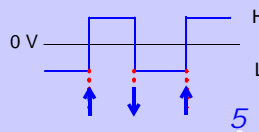
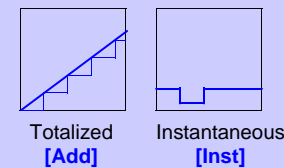
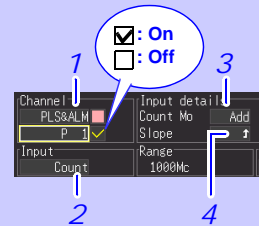

NOTE

- Use the scaling function to display integrated pulse counts as the corresponding physical units (such as Wh or VA) of the measurement parameter (p. 69).
- The counter saturates at 1,073,741,823 counts. If you expect to exceed this count, we recommend measuring with the Integration Mode (Count Mo) set to Instantaneous (Inst), and summing later with a spreadsheet program.

Revolution Measurement Settings

Configure these settings for each pulse channel on which you will be counting pulses corresponding to revolutions, such as output from a rotary encoder or tachometer. The revolution measurement is obtained by counting the number of pulses input per second. Make these settings on the [CH] screen.

See: "Key Setting Procedure" (p .53)

1 Select the input unit (PLS&ALM) and channel (P1 to P8), and check the box to enable the channel.

2 Select [Revolve].

3 Set the number of pulses per rotation output from the sensor.

- Increment/decrement by 1
- Increment/decrement by 10

Setting options:(* : default setting)

1* to **1000**

The range is automatically determined by this setting.

4 Select the basis of measurement (Slope).

Setting options:(* : default setting)

- Counts the number of revolutions based on L - H transitions.
- Counts the number of revolutions based on H - L transitions.

5 Select the High/Low reference (threshold) values.

Setting options:(* : default setting)

- 1V*** Judge 1.0 V or higher as HIGH, and 0 to 0.5 V as LOW.
- 4V** Judge 4.0 V or higher as HIGH, and 0 to 1.5 V as LOW.

6 Select a filter setting.

Setting options:(* : default setting)

- Off*** Filter is disabled.
- On** Filter is enabled. Prevents incorrect counts due to relay contact chatter (noise).

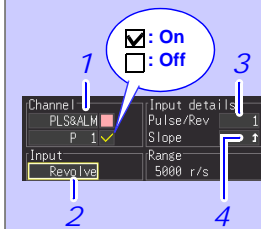

5000 r/s (n=1)

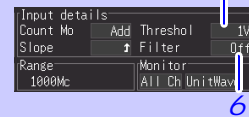
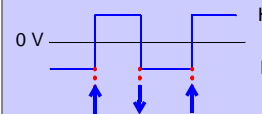

Revolution Measurement Theory

Pulse count is measured using the HiLogger's internal 10 ms sampling interval.

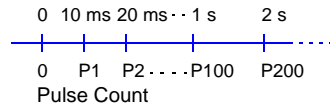

The revolution rate (r) per second during time t [s] is obtained by dividing the number of pulses from $(t-1)$ to t [s] by the number of pulses per revolution.

$$r [r/s] = \frac{\text{Pulse count at } t_s \text{ minus pulse count at } (t-1)_s}{\text{Pulses per revolution}}$$

(r/s : Revolutions per second)

Example: Pulses per revolution = 4

When the number of pulses counted in one second is $P_{100} = 1000$ c, and the number of pulses counted in two seconds is $P_{200} = 2000$ c, then the revolution rate (r/s) at $t=2s$ ($r_{t=2}$) can be obtained.

$$r_{t=2} = \frac{2000 - 1000}{4} = 250 [r/s]$$

Exception: When time t_s is less than one second

The pulse count at $(t-1)_s$ (whole seconds) cannot be measured, so 100 times the pulse count between $(t-0.01)_s$ and t_s serves and the pulse count for one second to obtain the revolution rate. As a result, revolution measurements when t is less than one second are scattered.

$$r [r/s] = \frac{\text{Pulse count at } t_s \text{ minus pulse count at } (t-0.01)_s}{\text{Pulses per revolution}} \times 100$$

NOTE

Use the scaling function to display integrated pulse counts as the corresponding physical units (such as Wh or VA) of the measurement parameter (p. 69).

3.4 Data Saving Settings

Before measuring, select whether to automatically save data to CF card or USB flash drive while measuring, or to immediately save manually (only when you press **SAVE**).

See Auto Saving (p. 125) and Immediate Saving (p. 128) for setting procedures.

3.5 Waveform Display Settings (as needed)

Set the waveform display settings as needed. These settings can be changed on the Numerical/Waveform screen after measurement (p. 85).

NOTE The Setting screen cannot be displayed while measuring.

Key Setting Procedure

1 WAVE/DATA SET FILE
Select the [CH] screen.

2 Move to a setting item.

Open the setting options for the item to be set.

Select from the listed options.

Apply

UNIT selects the input unit and the **CHAN** select the channel to be set.

Selecting Waveform Display Color

Different display colors can be selected for each input channel waveform.

Select from the waveform display color setting options.
Setting options: Off (x), 24-color

3.5 Waveform Display Settings (as needed)

Specifying Vertical Display Range by Magnification and Zero Position (vertical axis expansion/compression)

The vertical display range and zero position can be specified for each channel. The magnification setting determines the displayed range. Waveforms are expanded or compressed vertically relative to the center of the screen.

The display range of the vertical axis emphasizing 0V display position

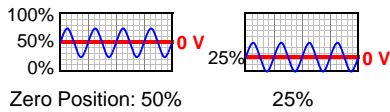

Display range magnification setting (expansion/compression)

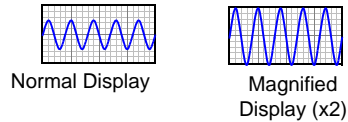

Make these settings on the [CH] screen.

See: "Key Setting Procedure" (p .65)

- 1 Select [Pos].
- 2 Select the magnification.
Setting options:(* : default setting)
x100, x50, x20, x10, x5, x2, x1*, x1/2
- 3 Set the desired zero position as a percentage of screen height.
Setting options:
-50 to 150% (with x1 magnification)

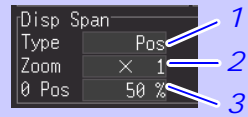

Change 1's digit

The expansion/compression range depends on the selected magnification.

Zoom	Zero-Position setting range	Zoom	Zero-Position setting range
x1/2	0 to 100%	x10	-950 to 1050%
x1	-50 to 150%	x20	-1950 to 2050%
x2	-150 to 250%	x50	-4950 to 5050%
x5	-450 to 550%	x100	-9950 to 10050%

Default Setting

Input type	Zoom	Zero position	Input type	Zoom	Zero position
Voltage	x1	50	Resistance (Resist)	x1	0
Temperature (Tc)	x1	0	Logic	-	-
Temperature (Rtd)	x1	0	Integration (Count)	-	-
Humidity (Humid)	x1	0	Revolution (Revolve)	x1	0

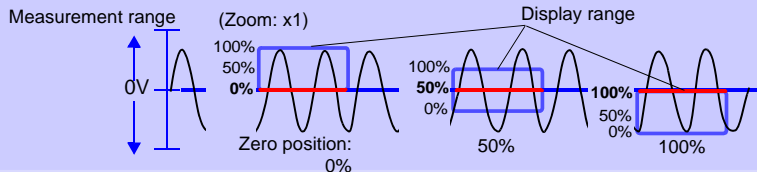

NOTE

Magnification and zero-position settings are ignored when the display range is defined by upper and lower limits.

Specifying the Vertical Display Range by Upper and Lower Limits (expansion/compression)

The vertical display range can be defined by upper and lower limits. Using this method, the voltage range does not need to be selected because the optimum range is selected automatically for the display.

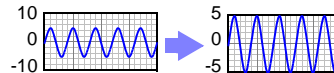

Make these settings on the [CH] screen.

See: "Key Setting Procedure" (p .65)

3

Chapter 3 Settings

1 Select [Up/Lwr].

2 Specify the [Upper] value for the top of the display.

Move the cursor to the numerical value and press **ENTER** to display the numerical setting dialog.

See: Numerical Value Entry (below)

3 Specify the [Lower] value for the bottom of the display.

Set in the same way as the upper value.

The display range and scaling settings are interlinked.

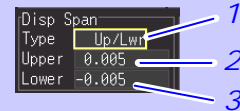

Numerical Setting Dialog

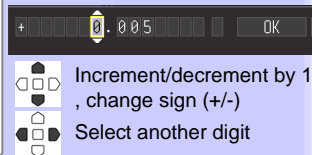

Default Setting

Input type	Upper/Lower Limits	Input type	Upper/Lower Limits
Voltage	-0.005 to 0.005	Resistance (Resist)	0 to 10
Temperature (Tc)	0 to 100	Logic	—
Temperature (Rtd)	0 to 100	Integration (Count)	0 to 5000
Humidity	0 to 100	Revolution (Revolve)	0 to 5000

■ Numerical Value Entry

- Select a digit to change with the left/right cursor keys, and increment/decrement the digit with the up/down keys.
(The rightmost character is for an optional measurement unit symbol. Pressing the up/down keys selects from among E - P - T - G - M - k - (blank) - m - u - n - p - f - a. If no unit symbol is needed, it can be left "blank".)
- When the desired value is selected, press **[OK]**.

NOTE

- However, upper and lower limit settings are ignored when magnification and zero position are enabled to define the display range.
- The range is not automatically optimized when the upper and lower limits are set on the Waveform/Numerical screen.

3.5 Waveform Display Settings (as needed)

Setting the Display Time Base (horizontal axis magnification)

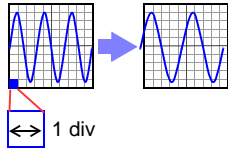

Displayed waveforms can be expanded or compressed along the horizontal axis. Shorter setting values correspond to greater magnification. Make these settings on the [Setting] screen.

See: "Time Setting by Key Operations" (p.50)

Settings can be changed during and after measurement on the [Wave+Value] display of the Waveform/Numerical screen(p. 89).

Select the time per division.

Setting options:(* : default setting)

100ms*, 200ms, 500ms, 1s, 2s, 5s, 10s, 20s, 30s, 1min, 2min, 5min, 10min, 20min, 30min, 1h, 2h, 5h, 10h, 12h, 1day [DIV]

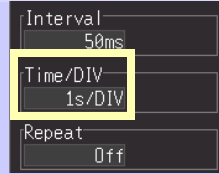

When auto save is enabled for waveforms

100, 200 and 500 ms settings are automatically changed to 1 s when measurement starts, and the shorter values cannot be selected while measuring.

The [Time/DIV] range depends on the [Interval] setting.

Horizontal axis display options are affected when the recording interval is changed after measuring, because the options for expanding (or compressing) the displayed axis depend on the recording interval used when measuring. When using the Logger Utility program with a LAN connection, recording intervals from 100 ms to 2 s are not available, regardless of auto save settings (5 s is automatically selected).

●: Selectable, x: Not selectable, △: Not selectable while measuring

Horizontal axis	Recording interval																				
	[ms]						[s]						[min]						[h]		
	10	20	50	100	200	500	1	2	5	10	20	30	1	2	5	10	20	30	1		
100ms	●	●	●	x	x	x	x	x	x	x	x	x	x	x	x	x	x	x	x		
200ms	●	●	●	●	x	x	x	x	x	x	x	x	x	x	x	x	x	x	x		
500ms	●	●	●	●	x	x	x	x	x	x	x	x	x	x	x	x	x	x	x		
1s	●	●	●	●	●	●	●	x	x	x	x	x	x	x	x	x	x	x	x		
2s	●	●	●	●	●	●	●	x	x	x	x	x	x	x	x	x	x	x	x		
5s	●	●	●	●	●	●	●	x	x	x	x	x	x	x	x	x	x	x	x		
10s	●	●	●	●	●	●	●	●	●	x	x	x	x	x	x	x	x	x	x		
20s	●	●	●	●	●	●	●	●	●	●	x	x	x	x	x	x	x	x	x		
30s	●	●	●	●	●	●	●	●	●	●	●	x	x	x	x	x	x	x			
1min	●	●	●	●	●	●	●	●	●	●	●	●	●	x	x	x	x	x			
2min	●	●	●	●	●	●	●	●	●	●	●	●	●	x	x	x	x	x			
5min	●	●	●	●	●	●	●	●	●	●	●	●	●	x	x	x	x	x			
10min	●	●	●	●	●	●	●	●	●	●	●	●	●	●	●	x	x	x			
20min	●	●	●	●	●	●	●	●	●	●	●	●	●	●	●	●	x	x			
30min	●	●	●	●	●	●	●	●	●	●	●	●	●	●	●	●	x	x			
1h	●	●	●	●	●	●	●	●	●	●	●	●	●	●	●	●	●	x			
2h	△	●	●	●	●	●	●	●	●	●	●	●	●	●	●	●	●	●			
5h	△	△	●	●	●	●	●	●	●	●	●	●	●	●	●	●	●	●			
10h	△	△	△	●	●	●	●	●	●	●	●	●	●	●	●	●	●	●			
12h	△	△	△	●	●	●	●	●	●	●	●	●	●	●	●	●	●	●			
1day	△	△	△	△	●	●	●	●	●	●	●	●	●	●	●	●	●	●			

3.6 Scaling Settings (as needed)

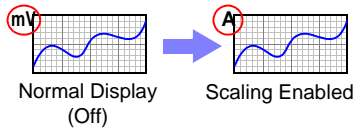

The Setting screen cannot be displayed while measuring.

Use the scaling function to convert input voltage to the physical units of the measurement parameter for display, such to convert voltage input for display as electrical current.

Converted values can be displayed in fixed or floating-point notation.

Make these settings on the [CH] screen.

See: "Key Setting Procedure" (p.65)

3

Chapter 3 Settings

Scaling Voltage, Temperature, Humidity, Resistance, and Revolution Measurements

1 Select the desired numerical notation.

Setting options:(* : default setting)

Dec	Displays converted values using fixed-point notation.
Exp	Displays converted values using floating-point notation.
Off*	Scaling is disabled.

2 Select the scaling method.

Setting options:(* : default setting)

Ratio*	Convert by specifying the ratio of physical units per volt of input signal (conversion ratio), offset, and the name of the units.
2-pt	Convert by specifying the input signal voltage at two points, the physical unit values at those points, and the name of the units.

3 Enter the [Unit] name on the comment entry screen. (Up to 7 characters)

See: About Comments (p. 71)

4 Ratio: Enter the conversion ratio and offset.

2-pt: Enter the values at two points before and after conversion.

Move the cursor to the numerical value and press **ENTER** to display the numerical setting dialog.

See: "Numerical Value Entry" (p.67)

With [Cond] set to [Dec]

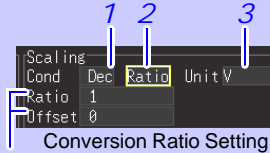

Conversion Ratio Setting

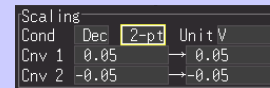

2-Point Setting

With [Cond] set to [Exp]

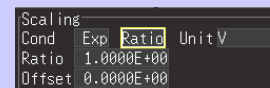

Conversion Ratio Setting

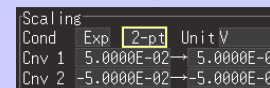

2-Point Setting

A value measured on CH1 of UNIT1 (Analog channel CH1-1) can be set as the scaling value (Inter-Channel Compensation function) (p. 79).

3.6 Scaling Settings (as needed)

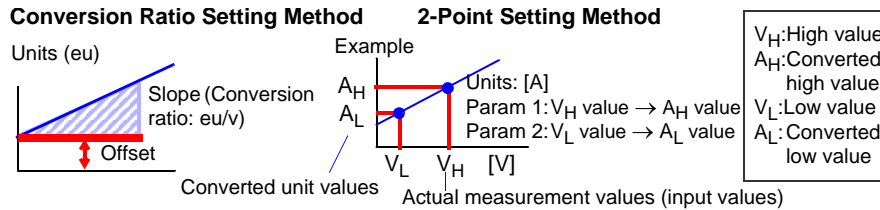

Integration Measurement Scaling Setting

Integrated pulse values can be converted for display as physical units of the measurement parameter (such as Wh or VA). Pulse output devices determine the amplitude per pulse in physical units, or the number of pulses per fundamental unit (for example, per kWh, liter or m^3).

- Select the desired numerical notation.**
Setting options: (* : default setting)

Dec	Displays converted values using fixed-point notation.
Exp	Displays converted values using floatingpoint notation.
Off*	Scaling is disabled.
- Enter the [Unit] name on the comment entry screen. Enter the [Unit] name on the comment entry screen. (Up to 7 characters)**
See: About Comments (p. 71)
- Specify the physical units per pulse or the number of pulses per fundamental unit (for example, if 1 c = 1 pulse, select [1 Pulse]).**
Move the cursor to the numerical value and press **ENTER** to display the numerical setting dialog.
See: "Numerical Value Entry" (p. 67)
The settings for physical units per pulse and pulses per fundamental unit are interlinked.

1 2

Scaling
Cond: Dec Unit: c
1 Pulse = 10 c
1 c = 0.1 Pulse

3

With Dec setting

Scaling
Cond: Exp Unit: c
1 Pulse = 1.0000E+01 c
1 c = 1.0000E-01 Pulse

With Exp setting

Scaling Setting Example

For integration with a 50,000 pulse/kWh watt-hour meter:

Cond: Dec
Units: kWh
1kwh=50000 pulse

For integration with a 10 liter/pulse flow meter:

Cond: Dec
Units: L
1 pulse=10L

NOTE

Combining scaling and display positioning (upper/lower limits)

To use both scaling and upper/lower display limits, set the scaling first, then upper/lower limit values.

Saving and loading data with scaling function

When the scaling function is set to enable, scaling information as well as raw data (non-converted data) in binary format are saved. When the data saved in the storage devices is loaded, the converted data will be displayed. The raw data can also be observed by resetting the scaling function to OFF.

3.7 Entering Titles and Comments (as needed)

Comments of up to 40 characters can be entered as a title for the measurement data, and as a label for each input waveform. Titles and comments are displayed on the waveform/numerical screen (Comments appear only when [Value+Cmnt] display is selected).

Titles can be entered on the [Setting] and [Comment] screens, and comments can be entered on the [CH] and [Comment] screens.

This description enters a comment on the [CH] screen.

NOTE The Setting screen cannot be displayed while measuring.

3

Chapter 3 Settings

1 Select the [CH] screen.

2 Select the field to enter the comment.

Apply
The character entry screen appears.

3 Select the characters to enter
To enter a space, select a blank character.

Apply
Characters appear in the entry field as you select them.

Finished with entry

Navigate the entry field

72

3.7 Entering Titles and Comments (as needed)

Operating Panel

The operating panel depicts the functions of HiLogger's operating keys.

List

Displays the pick list of pre-registered measurement-related phrases.

Hist

Displays a pick list of previously entered phrases.

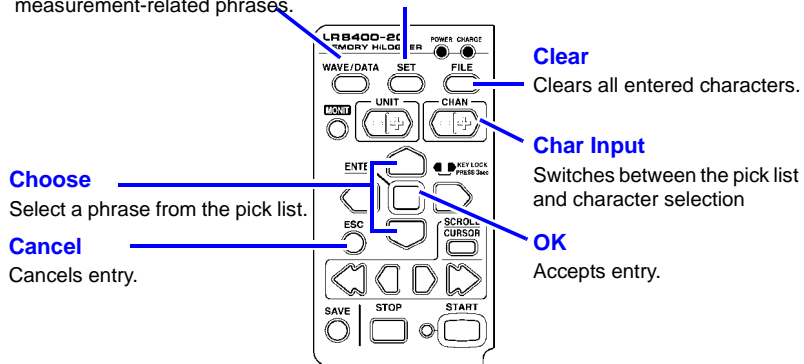

The following characters are converted as follows when saved to a text file.

Entered character	²	³	μ	Ω	°	ε
Converted plain text equivalent	^2	^3	~u	~o	~c	~e

3.8 Suppressing Noise (Enable Digital Filtering)

Electrical noise mixed with input signals can be removed by digital filtering.



Noise suppression is most effective for longer recordings, where it can provide higher measurement accuracy and less scattering. Unless the timing difference between channels needs to be minimized, we recommend selecting 50 or 60 Hz to match the local line frequency.

See: "Cut-off frequency" (p .237)

NOTE The Setting screen cannot be displayed while measuring.

Setting Procedure

Make these settings on the **[Setting]** screen.

See: "Time Setting by Key Operations" (p .50)

[Filter]

Setting options:(* : default setting)

60Hz*, 50Hz, OFF

Filter

60 Hz

fc = 13020Hz

Fc: Cut-Off Frequency

- Select 50 or 60 Hz to match the local line frequency.
- When 50 or 60 Hz is selected, longer recording intervals provide lower cut-off frequencies and better noise suppression.
- A larger number of channels (input units) raises the cut-off frequency for a specific recording interval, and weakens noise suppression.

See:"Cut-off frequency" (p .237)
- When 50 or 60 Hz is selected, the measurement timing difference between channels increases relative to the recording interval.

Disable filtering (set to Off) to minimize the timing difference between channels (to within 500 μ s for adjacent channels, and 10 ms for all channels).

3.9 Viewing and Editing with the All-Channel Settings List

All channel settings can be viewed and changed in the list. You can copy batches of settings between channels.



The Setting screen cannot be displayed while measuring.

[Range] screen

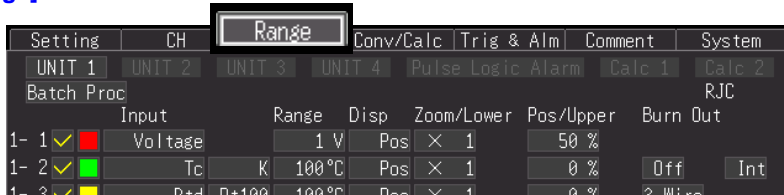

[Conv/Calc] screen

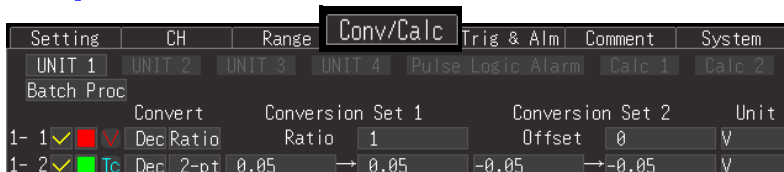

Input type (V: Voltage, Tc: Thermocouple, Rtd: RTD, H: Humidity, R: Resistance, I: Integration, Rev: Revolution, A: Alarm)

[Trig & Alm] screen

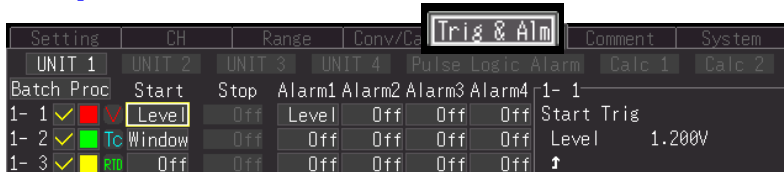

Input type (V: Voltage, Tc: Thermocouple, Rtd: RTD, H: Humidity, R: Resistance, I: Integration, Rev: Revolution, A: Alarm)

[Comment] screen

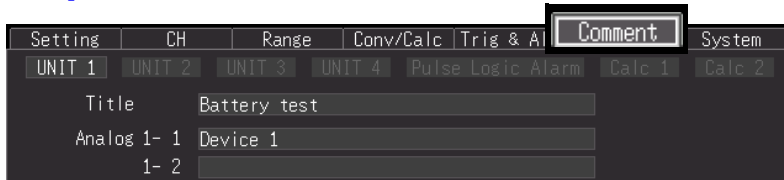

Batch Copying Channel Settings

The CH1-1, CH2-1, CH3-1, CH4-1, P1, W1, and W16 channel settings can be copied to other channels.

1 Select the screen showing the channel to copy. [Range], [Conv/Calc], [Trig & Alm]

2 Select a unit.

3 Select [Batch Proc].

4 Select the desired action. The actions that can be selected depend on the input units (see below).

Apply
The selected items are displayed.

Apply

■ **UNIT1 to UNIT4**

- [Copy the settings of CH1-1 shown on screen to CH1-2 till CH1-15.]
(X indicates a measurement unit symbol.)
Copies the settings from channel CH1 on the screen to channels CH2 to CH15 in the same input unit.
- [Copy the settings of CH1-1 shown on screen to all analog CHs.]
Copies the settings from channel CH1 on the screen to the enabled (On) channels in UNIT2 to UNIT4.

■ **Pulse Logic Alarm**

- [Copy the settings of P1 shown on screen to other pulse CHs.]
Copies the settings from channel P1 on the screen to channels P2 to P8. Logic settings cannot be copied.

■ **calc1**

- [Copy the settings of W1 shown on screen to W2 till W15.]
Copies the settings from waveform calculation channels W1 and W16 on the screen to channels W2 to W15.
- [Copy the settings of W1 shown on screen to all the other waveform calc. CHs.]
Copies the settings from waveform calculation channel W1 on the screen to the enabled (On) channels from W2 to W30.

■ **calc2**

- [Copy the settings of W16 shown on screen to W17 till W30.]
Copies the settings from waveform calculation channel W16 on the screen to channels W17 to W30.

NOTE

- The contents of the displayed settings are copied, except for "waveform display color", "input type", and "measurement On/Off settings". However, "input type" and "measurement On/Off settings" can be copied from the [Range] screen.
- RTD (Resistance Temperature Detector) and resistance settings (specific to a Universal Unit) cannot be copied to a Voltage/Temperature Unit.

Batch Setting Waveform Display/Hide and Waveform Color Settings for All Channels

The display of all waveforms can be hidden, and all waveform display colors can be set to defaults. This setting is only available on the **[Range]** screen.

The diagram illustrates the process of batch setting waveform display and color settings for all channels. It is divided into two main steps:

- 1 Select [Batch Proc].** This step involves navigating through the menu structure (represented by icons) to select the **[Batch Proc]** option. A screenshot of the device's menu shows the **Batch Proc** option highlighted in a yellow box.
- 2 Select the desired action.** This step involves selecting the specific action to be applied to all channels. A screenshot of the device's menu shows two options: **Set all analog channels color off** and **Set all analog channels color default**, both highlighted in a yellow box.

The background of the diagram shows a simplified menu structure with icons for navigating between different settings screens.

Initializing Settings (to factory defaults)

Certain settings in all input units (or a selected input unit) can be reset to their factory default state.

1 **WAVE/DATA** **SET** **FILE**
Select which screen you want to initialize, from the [Range], [Conv/Calc], [Trig & Alm] screens.

2 Select a unit.

3 Select [Batch Proc].

Apply
The selected items are displayed.

4 Select the desired action.
The actions that can be selected depend on the display screen (see below).

Apply

3

Chapter 3 Settings

■ **[Range] Screen**

- **[Initialize all the range settings of all units shown on screen.]**
Resets the range screen settings of all input units.
- **[Initialize all the settings of this unit shown on screen.]**
Resets the range screen settings of the selected input unit.

■ **[Conv/Calc] Screen**

- **[Initialize all the scaling settings of all units.]**
Resets the scaling settings of all input units.
- **[Initialize all the waveform calculation settings of all units.]**
Resets the waveform calculation settings of all input units.
- **[Initialize all the settings of this unit shown on screen.]**
Resets the conversion/calculation settings of the selected input unit.

■ **[Trig & Alm] Screen**

- **[Initialize all the trigger/alarm settings of all units on screen.]**
Resets the [Trig & Alm] screen settings of all input units.
- **[Initialize all the settings of this unit shown on screen.]**
Resets the [Trig & Alm] screen settings of the selected input unit.

Aligning Zero Positions on the Grid

All channels in every unit (CH1-1 to 15, CH2-1 to 15, CH3-1 to 15, CH4-1 to 15 and P1 to ALM4) can be displayed evenly spaced at 5% or 10% intervals on the vertical axis, from top to bottom.

Only those channels set for the same input type and range as the reference channel, and with [Disp span] set to [Pos] (p. 66), are valid.

1 Select [Batch Proc.]

Apply
The selected items are displayed.

2 Select the desired action.

Apply

Setting CH Range Conv/Calc
UNIT 1 UNIT 2 UNIT 3 UNIT 4 Pul
Batch Proc
input Range Disp Zoo
1- 1 ✓ Voltage 1 V Pos X

Copy the settings of CH1-1 shown on screen to all analog CHs
Put all channels at 5% intervals with CH1 zero position reference
Put all channels at 10% intervals with CH1 zero position reference
Set all analog channels color on
Set all analog channels color default
Correct max/min values to the same as CH-1 when input type is same

Alignment Example (with CH1-1 zero-position aligned at 90% and occupying 5% of vertical screen height)

Channel	Zero-position (%)
CH1-1	90
CH1-2	85
CH1-3	80
CH1-4	75
CH1-5	70
CH1-6	65
CH1-7	60
CH1-8	55
CH1-9	50
CH1-10	45
CH1-11	40
CH1-12	35
CH1-13	30
CH1-14	25
CH1-15	20

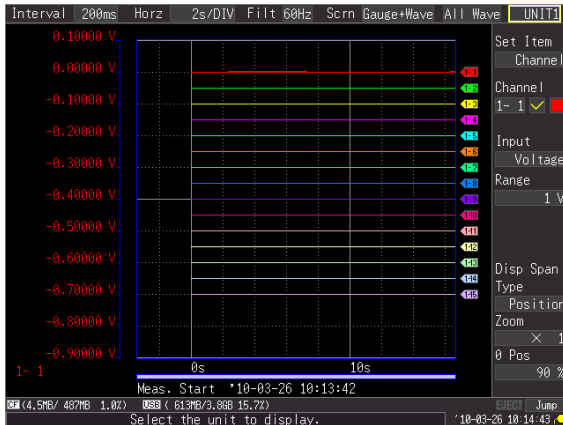

Setting CH1 of UNIT1 Value as a Scaling Value (Inter-Channel Compensation function)

A value measured on CH1 of UNIT1 (Analog channel CH1-1) can be set as the scaling value. This function is convenient for thermocouple measurements when errors (such as thermocouple deviations) give different values for the same known temperature.

It applies only to channels with the same input type and range setting as CH1 of UNIT1.



3

Chapter 3 Settings

NOTE

When scaling is automatically set by steps 1 to 6 on next page procedure, the measurement units are initially set to [V].

To set all channels to [°C] make the following settings beforehand.

1. Set the [Convert] setting to [Dec] and [unit] to [°C] on the [Conv/Calc] screen.

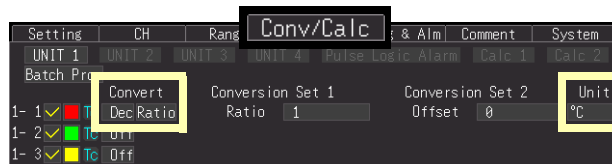

2. For [Batch Proc], execute [Correct the value to the same as CH1 when input type is same.] (p. 75).

3.9 Viewing and Editing with the All-Channel Settings List

1 WAVE/DATA SET FILE
Select the [Conv/Calc] screen.

2 Select [Batch Proc].

Apply
The selected items are displayed.

3 Select the desired action.

Apply

To display waveforms at the same position as CH1, next select the display position as follows. (Applies to the upper/lower limits set for CH1)

4 WAVE/DATA SET FILE
Select the [Range] screen.

5 Select [Batch Proc].

6 Select the desired action.

Apply

Setting CH Range Conv/Calc T
UNIT 1 UNIT 2 UNIT 3 UNIT 4 Pulse
Convert Conversion Set 1
1- 1 ✓ Dec Ratio Ratio 1
1- 2 ✓ To Dec 2-pt 0.05 → 0.05

Display temperature on all channels using *5 after scaling conversion.
Correct the value to the same as CH-1 when input type is same.
Close

Setting CH Range Conv/Calc T
UNIT 1 UNIT 2 UNIT 3 UNIT 4 Pulse
input Range Disp Zoom
1- 1 ✓ Voltage 1 V Pns X

Set all analog channels color on.
Get all master channels color default.
Correct max/min values to the same as CH-1 when input type is same.
Close

Display Celsius (°C) temperature values as Fahrenheit (°F)

All measured temperature values can be converted at once from Celsius to Fahrenheit units.

The conversion is simultaneously reflected appropriately on all scaled values.

To revert from Fahrenheit units to Celsius, disable (set to Off) the scaling function (p. 69).

This setting is only available on the [\[Conv/Calc\]](#) screen.

1 Select **[Batch Proc]**.

Apply
The selected items are displayed.

2 Select the desired action.

Apply

UNIT 1	UNIT 2	UNIT 3	UNIT 4	Puts
Batch Proc				
Convert		Conversion Set 1		
1 ✓	Dec Ratio	Ratio	1	

Display temperature on all channels using °F after scaling conversion

Close

Observing Measurements and Data

Chapter 4

4.1 Confirming Measured Values, and Starting Measurement

Before starting a formal measurement, press **MONIT** to check measured values as needed (p. 26).

When you have confirmed that the settings are correct, press **START** to start formal measurement (p. 23).

Pay attention to the following items while measuring.

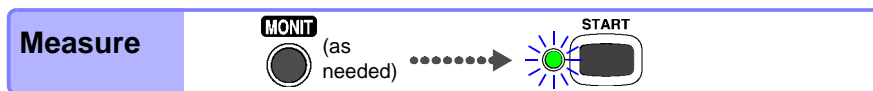

4

Chapter 4 Observing Measurements and Data



- This table shows the maximum applied voltage ratings for the analog input units and the HiLogger's external control I/O terminals, between grounds, and between channels. To avoid electric shock accidents and damage to the HiLogger, do not exceed these voltages.
- Channels are insulated by semiconductor relays. When a voltage beyond the specification is applied between the channels, the semiconductor relay may short circuit. Please ensure that a voltage beyond specification, especially a surge such as a lightning, is never applied. When an abnormal measurement value is observed, please contact your dealer or Hioki representative for inspection.

Input and Output Terminals	Maximum Input Voltage	Maximum rated voltage to earth	Max. Inter-Channel Voltage
Analog Input Terminals (both Voltage/Temp Unit, and Universal Unit)	±100 VDC	300 V AC,DC	Voltage/Temp Unit: 250 VDC Universal Unit: 300 VDC, however, RTDs are not isolated between channels
Pulse Input Terminals	0 to 50 VDC	Non-Isolated (HiLogger/GND Common)	Non-Isolated (HiLogger/GND Common)
Alarm Output Terminals	–	Non-Isolated (HiLogger/GND Common)	Non-Isolated (HiLogger/GND Common)
External Trigger (EXT.TRIG) Terminal	0 to 10 VDC	Non-Isolated (HiLogger/GND Common)	–
Trigger Output (TRIG.OUT) Terminal	-20 to 30 VDC	Non-Isolated (HiLogger/GND Common)	–

- Never apply voltage to the alarm output terminals. The HiLogger will be damaged.
- The grounds for the EXT TRG and TRIG OUT terminals are common with the HiLogger grounds (GND), and are not isolated. To avoid damaging the HiLogger, connect wiring so as to avoid any potential difference between the grounds of the EXT TRIG and TRIG OUT terminals and connected devices (or system).

4.2 Observing Waveforms

View data during and after measuring on the Waveform/Numerical Screen.

Displaying Waveforms (Display Descriptions)

Press the **WAVE/DATA** to display the Waveform/Numerical screen. Repeated key presses cycle the screen through seven types (p. 19).

Screen Example: [Wave] display (* : default setting)

Settings can be changed.
(See indicated page for details)

- Recording interval (data acquisition interval) (p. 50)
- Display time base (time per horizontal division) (p. 68)
- Digital filtering (noise suppression) (p. 73)

All Waveforms/Unit Waveforms

[All Wave*]
Displays the waveforms for all channels enabled for measurement (On).

[UnitWave]
Displays the waveforms of each input unit.

4

Chapter 4 Observing Measurements and Data

Trigger Mark
Indicates a trigger event

Analog, pulse, and logic waveforms
Displays acquired data as waveforms.

Time Values
0s 10s 20s

Scroll Bar
Shows the range and position of the displayed waveform.
Viewing the Scroll bar (p. 88)
Information such as measurement start time and start trigger times is displayed below the scroll bar.

UNIT1* - W30
Select the input unit with the waveforms to view when [UnitWave] is selected.
Press **UNIT** to switch input units.
Input units can be switched in jumps as described below.





Jump Function (p. 89)

The screen display span also be changed here. ([Gauge+Wave *])

- A gauge can be displayed for each channel, and channel settings can be changed (p. 86).
- Measurement data can be displayed as waveforms and numerical values, as numerical values with comments, or as numerical values only (p. 87).
- Numerical values at waveform cursor positions can be viewed (p. 91)
- Numerical calculation results can be displayed (p. 143)

Unit 1 (1-1 to 15)→Unit 2 (2-1 to 15)→Unit 3 (3-1 to 15)→Unit 4 (4-1 to 15)→Pulse/Alarm (P1 to P8), (ALM1 to ALM4)→Waveform Calculation 1 (W1 to 15)→Waveform Calculation 2 (W16 to 30)→returned to Unit 1 (1-1 to 15)

Key Setting Procedure

-  **Move to a setting item.**
-  **Open the setting options for the item to be set.**
-  **Select from the listed options**
-  **Apply**

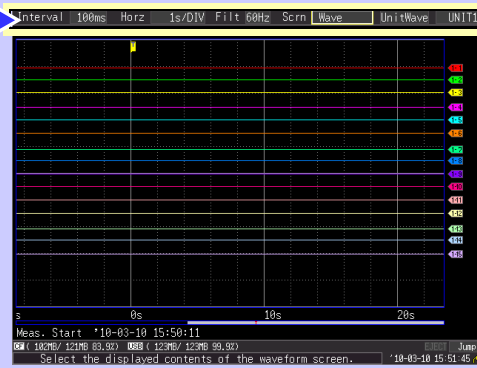

Displaying Gauges

A gauge corresponding to the measurement range of each channel can be displayed at the left side of the screen, for confirming measurement values. The color of the gauge matches the waveform display color of its input channel. Channel settings can also be changed.

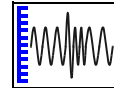

You can switch between channel settings and event search settings.

- Event Search (p. 93)

Display area settings

- Display position (p. 66)
- Upper and lower display limits (p. 67)

Gauge

Select [Gauge+Wave].

- Voltage measurement (p. 55)
- Temperature measurement (Thermocouple) (p. 56)
- Temperature measurement (RTD) (p. 58)
- Humidity measurement (p. 59)
- Resistance Measurement (p. 60)
- Pulse/Logic Measurement (p. 61)
- Integration (pulse count) (p. 62)
- Revolution measurement (p. 63)
- Select the alarm display type (p. 109)
- Waveform Calculation (p. 149)

About Channel Settings

Press **CHAN** to select channels for gauge display.

However, note that when measurement data is displayed, only those channels that are enabled (set to On) for measurement can be selected.

When starting measurement with all channels disabled (Off), CH1-1 (only) is automatically enabled.

Viewing Input Signals as Numerical Values

Numerical values can be displayed in three ways: numerical values only, waveforms and numerical values, and numerical values and comments.

Displayed numerical values are those of the current input signals.

See: To view cursor position values numerically: "Displaying Cursor Values" (p .91)

To display waveforms and numerical values

UNIT1	36.30s
1- 1	0.26350 V
1- 2	0.26300 V
1- 3	0.26360 V
1- 4	0.26375 V
1- 5	0.26355 V
1- 6	0.26375 V
1- 7	0.26385 V
1- 8	0.26390 V
1- 9	0.26370 V
1-10	0.26385 V
1-11	0.26370 V
1-12	0.26385 V
1-13	0.26410 V
1-14	0.26385 V

To display numerical values and comments

UNIT1	36.30s	Comment
1- 1	0.26310 V	Device 1
1- 2	0.26275 V	
1- 3	0.26305 V	Pressure
1- 4	0.26265 V	Power
1- 5	0.26280 V	
1- 6	0.26240 V	
1- 7	0.26260 V	
1- 8	0.26225 V	
1- 9	0.26245 V	
1-10	0.26195 V	
1-11	0.26215 V	
1-12	0.26185 V	
1-13	0.26200 V	
1-14	0.26175 V	

To display numerical values only

UNIT1	36.30s
1- 1	0.26310 V
1- 2	0.26275 V
1- 3	0.26305 V
1- 4	0.26265 V
1- 5	0.26280 V
1- 6	0.26240 V
1- 7	0.26260 V
1- 9	0.26245 V
1-10	0.26195 V
1-11	0.26215 V
1-12	0.26185 V
1-13	0.26200 V
1-14	0.26175 V
1-15	0.26175 V

Depending on the scaling setting, channels that require more than 16 characters to display both the measured value and unit symbols may be displayed in smaller characters.

Scrolling Waveforms

When measuring or displaying an existing waveform, use **SCROLL/CURSOR** to scroll. (While measuring, waveforms can be freely viewed up to the current measurement point.)

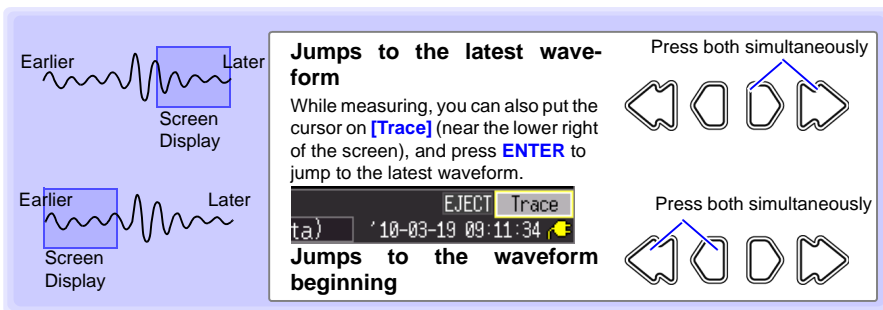
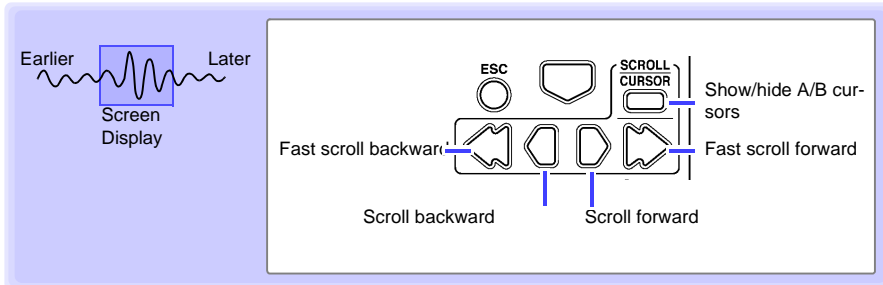

When measuring with [Cont] set to [On]

If internal memory becomes full, recording continues by overwriting the oldest acquired data. Because of that, scrolled waveforms viewed while measuring are limited to the part that has not yet been erased.

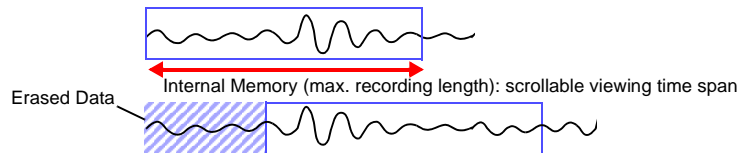

Verifying Waveform Display Position

From the scroll bar you can verify the relative position and size of the displayed portion of a waveform within the overall measured waveform.

The width of the currently displayed time span indicator within the scroll bar depends on the time base (time per horizontal division) setting, even when the recording length is unchanged.

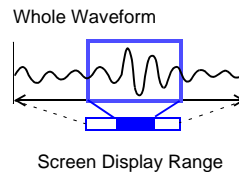

Magnifying and Compressing Horizontally

Waveforms can be magnified (expanded or compressed) along the time axis by changing the time per horizontal division. Detailed waveform data is usually best observed with the time axis expanded, while longer-term trends are best observed with it compressed.

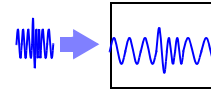

Horizontal magnification can be changed while measuring.

However, when measuring with auto saving enabled, the 100, 200 and 500 ms settings are not selectable.

Select from the [Horz] setting options.

Setting options:(* : default setting)

100ms*, 200ms, 500ms, 1s, 2s, 5s, 10s, 20s, 30s, 1min, 2min, 5min, 10min, 20min, 30min, 1h, 2h, 5h, 10h, 12h, 1day, [/DIV]

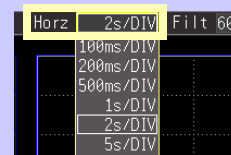

Indicates the center point for horizontal magnification. When the A/B cursors are displayed, the position of cursor A becomes the reference point.

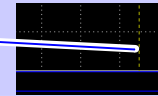

Viewing Any Waveform Location (Jump Function)

When the recording length of a waveform is long, you can specify the portion to be displayed immediately. This is available only when measurement is stopped. While measuring, [Jump] is changed to [Trace] (p. 88).

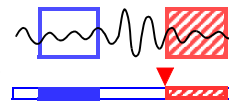

- 1 **Select [Jump].**
- Apply**
The location of the currently displayed portion of the overall waveform is indicated by the ▼ mark on the scroll bar.
- 2 **Move the ▼ mark to display a different portion of the waveform.**
The portion of the waveform at the ▼ mark is displayed.
- 3 **Apply**

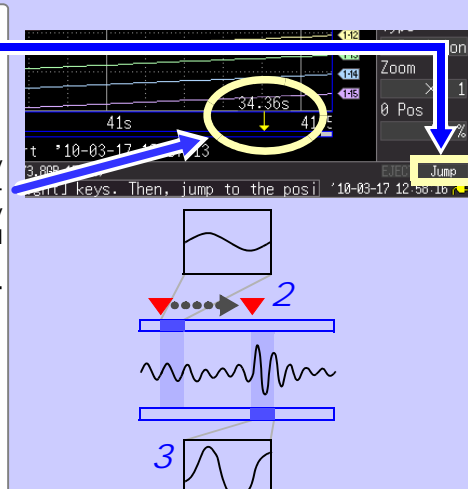

Specifying a Waveform Time Span

Specify a waveform time span when saving a partial waveform or applying numerical calculations (Trace cursors or Vertical cursors).

1 Press **SCROLL/CURSOR** to display A/B cursors and their values.

2 Select **[Move]**.

Open the setting options for the item to be set.

Select which cursor(s) to move.

Apply

3 Move the A/B cursors using the left/right cursor keys to specify the time span.

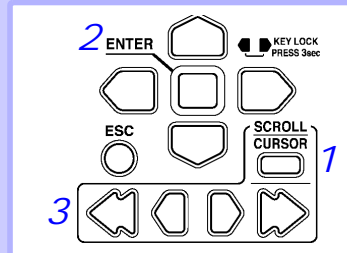
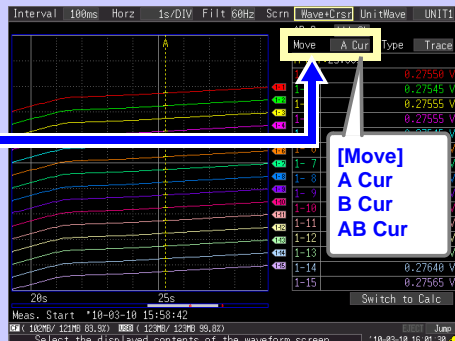

Displaying Cursor Values

Time difference and potential difference (and when scaling is enabled, scaling values) can be read as numerical values using the A/B cursors.

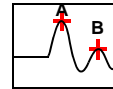

1 Press **SCROLL/CURSOR** to display A/B cursors and their values.

(To hide the cursor items again, press **SCROLL/CURSOR**.)

2 Move the A/B cursors using the left/right cursor keys.

Values along the waveforms can be confirmed.

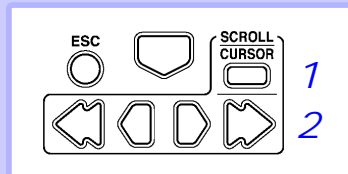
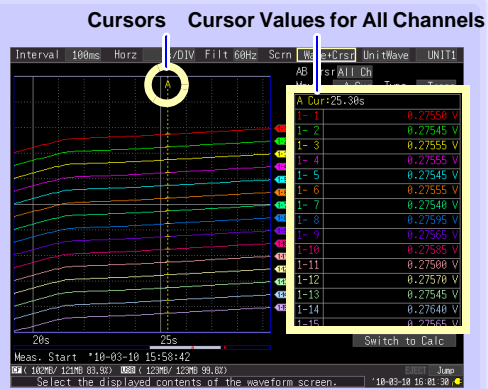

Cursor values can be displayed for all channels, or for only desired channels (p. 92).

Selecting which channels have their cursor values displayed

Select from the [AB Crsr] setting options.

- [All Ch]*
Displays all channels. The cursor selected for [Move] is displayed. (Selecting [AB Cur] displays the difference between A and B cursor values.)
- [Ch Set]
Specify which channels to display with A and B cursors. The cursor values for the specified channels are displayed.
(* : default setting)

Cursor Value for Specified Channels

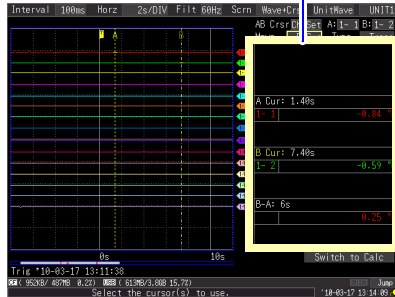

t	60Hz	Scrn	Wave+Crsr	UnitWave	UNIT1
AB Crsr	Ch Set	A: 1- 1	B: 1- 2		
Move	B Cur	Type	Trace		

To select which cursor to move

Select from the [Move] setting options.

- A Cur*
- B Cur
- AB Cur
(* : default setting)

Changing Cursor Type

Select from the [Type] setting options.

- Trace*
- Vert (Vertical)
- Horz (Horizontal)
(* : default setting)



Press the outer left and right scrolling keys to scroll in large steps.

About Cursor Types

Cursor Type	Example	Cursor Value
Trace Cursors		Displays the time and measurement values at the A/B cursors, or the time and measurement differences between the A/B cursors. Displays the intersections (trace points) of cursors and waveforms. (the intersections of waveform traces of selected channels)
Vertical Cursors		Displays the time and frequency values at the A/B cursors, or the time and frequency differences between the A/B cursors.
Horizontal Cursors		Displays the measurement values at the A and B cursors for the selected channel(s), or the difference between A/B cursor values. A/B cursors can be enabled for any channel.

4.3 Marking Waveforms and Searching Marks (Search Function)

You can insert up to 100 event marks at any point while measuring, to help find them later.

See: "Searching Event Marks" (p. 97)

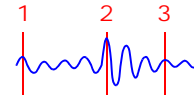

Event marks can be applied by the following methods.

- Press **START** while measuring
- Press the on-screen **[Make Mark]** button.
- Apply a signal to the EXT TRIG terminal
- When a warning occurs

Inserting Event Marks While Viewing Waveforms

Use this procedure to insert event marks while viewing data on the Waveform/Numerical Value screen during measurement.

Press **START** to apply a mark.

Event marks are numbered in the sequence they are inserted.

Marks can also be applied with the following procedures.

1 WAVE/DATA SET FILE
Select **[Gauge+Wave]**.

2 Select **[Channel]**.

Select **[Event]**.

Apply





3 Move to **[Make Mark]**.

Press to insert an event mark.
Event numbers appear on the waveform displayed when you select **[Make Mark]**.

The event settings are displayed.

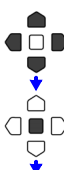
Inserting Event Marks Using External Input Signals

Event marks can be inserted by applying external input signals.
Make this setting before starting measurements.

- 1  Select the [System] screen.
- 2  Select [External Trig In].
 Open the setting options for the item to be set.
 Select [Event].
- 3  Apply

3 Connect and configure the external signal input (p. 106)
An event mark is inserted when the external trigger input (EXT TRIG external control terminal) switches from High to Low (falling edge) while measuring.
See: For input signal specifications: "Trigger Input Signals" (p.107)

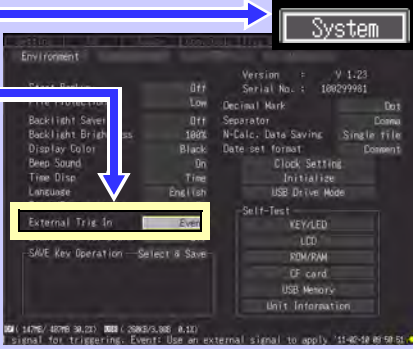

The screenshot shows the 'System' settings menu. The 'External Trig In' option is highlighted with a yellow box. Below it, the 'Event' option is selected. The menu also shows various other settings like Environment, Backlight, Display Color, Time, Language, and Self-Test.

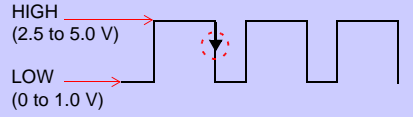

HIGH (2.5 to 5.0 V)
LOW (0 to 1.0 V)

The diagram shows a square wave signal. A red dashed line indicates the falling edge of the signal, which is the point where an event mark is inserted.

4.3 Marking Waveforms and Searching Marks (Search Function)

Alarm Event Marks

Event marks can be inserted by alarm events.
Make this setting before starting measurements.

1 **WAVE/DATA** **SET** **FILE**
Select the **[System]** screen.

2
Select **[Event mark for alarm]**.
Open the setting options for the item to be set.
Select **[On/Off]**.
Apply

System

Environment
Version : V 1.23
Serial No. : 18029981
Decimal Mark : Dot
Separator : Comma
N-Calc. Data Saving : Single file
Date-set format : Comment
Backlight Save : Off
Backlight Bright : 100%
Display Color : Black
Beep Sound : On
Time Disp : Initialize
Language : English
Start/Stop : On

Event mark for alarm : Off

KEY/LED
LCD
ROM/RAM
CF-card
USB Memory
Unit Information

107MS/107MS 36.20 2008/3/30 8:10
signal for triggering. Event: Use an external signal to apply. '01-40-00 00 00 01'



4.3 Marking Waveforms and Searching Marks (Search Function)

How are event marks handled in text (CSV) conversion?

The HiLogger's text conversion process includes event numbers along with measured values. This is convenient when you need to later extract only marked data.

<Example>

File name	WAVE0001.CSV						
Title comment							
Trigger Tmr	#####						
Ch	A 1- 1	A 1- 2	A 1- 3	Z 1	Z 2		
Mode	Voltage	Voltage	Voltage	Calculation	Calculation		
Range	10mV	10mV	10mV				
Comment							
Scaling	OFF	OFF	OFF				
Ratio	1.00E+00	1.00E+00	1.00E+00				
Offset	0.00000E+00	0.00000E+00	0.00000E+00	0.00000E+00	0.00000E+00		
Time	1-1 [V]	1-2[V]	1-3[V]	Event			
0.00E+00	-1.18E-04	-1.23E-04	-1.98E-04	0			
5.00E-01	-1.19E-04	-1.22E-04	-1.97E-04	0			
1.00E+00	-1.20E-04	-1.22E-04	-1.97E-04	1			
1.50E+00	-1.20E-04	-1.21E-04	-1.97E-04	0			
2.00E+00	-1.21E-04	-1.20E-04	-1.96E-04	0			
2.50E+00	-1.23E-04	-1.18E-04	-1.96E-04	2			
3.00E+00	-1.23E-04	-1.18E-04	-1.95E-04	0			
3.50E+00	-1.24E-04	-1.16E-04	-1.94E-04	3			
4.00E+00	-1.25E-04	-1.16E-04	-1.93E-04	0			
4.50E+00	-1.27E-04	-1.15E-04	-1.93E-04	4			
5.00E+00	-1.28E-04	-1.14E-04	-1.90E-04	0			
5.50E+00	-1.30E-04	-1.12E-04	-1.89E-04	0			
6.00E+00	-1.31E-04	-1.12E-04	-1.87E-04	0			

NOTE

The Logger Utility program's text conversion process does not include event mark information.

4.3 Marking Waveforms and Searching Marks (Search Function)

Searching Event Marks

Any event mark can be found by searching.

1 Select the Waveform/Numerical Value Screen.

2 When [Channel] is displayed, switch to [Event].

3 Select [MoveNo.].

4 Select [Move].

Apply
The event setting items are displayed.

Apply
The waveform with the specified event number is displayed.

You can search by incrementing and decrementing the event number.

PrevEvent	Search for the previous event mark.
NextEvent	Search for the next event mark.

Specifying Criteria for Measurements

Chapter 5

You can set recording to start and stop under specific criteria (start/stop triggers), and to output alarm signals. You can also set specific times to start and stop recording, using the Timer function.

About Triggering

Triggering is the process of controlling the start and stop of recording by specific signals or conditions (criteria). When recording is started or stopped by a specific signal, we say the trigger is "applied" or "triggering occurs".

In this manual, **T** indicates a "trigger point", as the time at which a trigger is applied.

Criteria can be specified for the following event trigger types.

Trigger criteria met

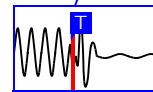

Trigger Type	Description	Setting Screen	Ref.
Start Trigger	Recording starts when the specified Start Trigger criteria are satisfied.	[CH]/ [Trig & Alm]	(p. 100)
Stop Trigger	Recording stops when the specified Stop Trigger criteria are satisfied. When [Repeat] is enabled (set to [On]), recording restarts automatically.	[CH]/ [Trig & Alm]	(p. 100)
Trigger Source	Various trigger criteria can be combined with logical AND/OR operations for each channel.	[Trig & Alm]	(p. 105)
External Trigger	Triggering can be applied by an external signal at the EXT.TRIG input terminal.	[Trig & Alm]	(p. 106)
Pre-trigger	Records data acquired during a specified period prior to each trigger event.	[Trig & Alm]	(p. 108)
Alarm	An alarm signal can be output when any specified criteria are met.	[CH]/ [Trig & Alm]	(p. 109)
Timer	Records at a specified date and time.	[Setting]	(p. 115)

Set trigger criteria for individual channels on the Channel [CH] screen, and set trigger and alarm settings for all channels on the [Trig & Alm] screen (p. 114).

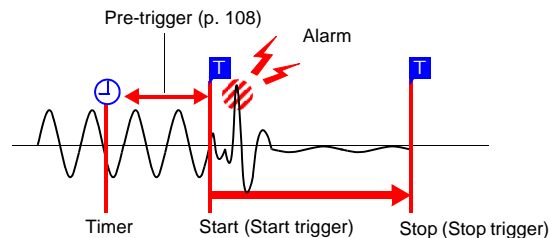

5.1 Triggering Measurement Start and Stop

There are three ways to set the criteria to start and stop recording according to waveform slope.

Select whether to trigger at the rising or falling edge of the input signal.

Types of Trigger Criteria

Type of Analog Trigger	Trigger Example	Description
Level Trigger (p. 102) [Level]		Recording starts (or stops) when the input signal crosses the specified trigger level (voltage).
Window Trigger (p. 103) [In]		Recording starts (or stops) when the input signal enters a range defined by upper and lower thresholds.
[Out]		Recording starts (or stops) when the input signal exits a range defined by upper and lower thresholds.
Logic Trigger (p. 104) [1]		Measuring starts and stops when the input signal logic switches from Low to High.
[0]		Measuring starts and stops when the input signal logic switches from High to Low.
[X]		Signal is ignored. No triggering occurs.

Enable the Trigger Function

Before setting trigger criteria, trigger functions need to be validated.

Enable the Trigger Function
1. Select the trigger to use, and press ENTER.
 Put the cursor on [Start trig on.] for a start trigger, or on [Stop trig on.] for a stop trigger, and press ENTER.
2. Press it again when the confirmation message appears.
 [Cond:Off] appears, and trigger criteria settings are enabled.
 When [Cont:**] is displayed, triggering is enabled (On).
 To disable triggering, set [Trig Func:Off] on the [Trig & Alm] screen.

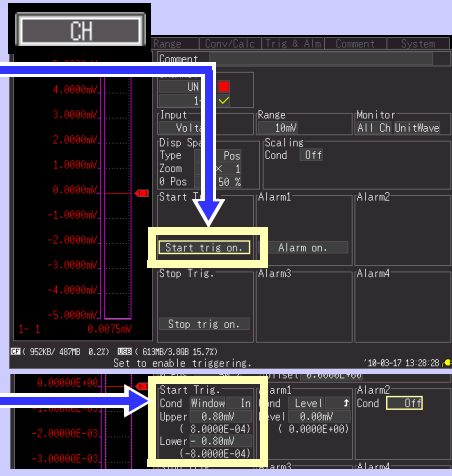

Set trigger criteria
Select the trigger criteria to be applied
See: P.102 to P.104
 Triggering can be enabled/disabled (On/Off) and criteria selections can be set on the [Trig & Alm] screen.(p. 114)

The [Timing] setting on the [Trig & Alm] screen determines the effect of triggering, as follows:

- Start recording upon trigger: [Start]
- Stop recording upon trigger: [Stop]
- Alternately start and stop upon trigger: [Start/Stop]

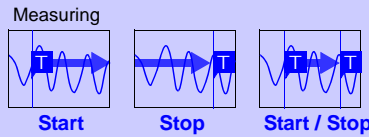

Key Setting Procedure

1. Select the [CH] or [Trig & Alm] Screen.
2. Move to a setting item.
- Open the setting options for the item to be set.
- Select from the listed options.
- Apply

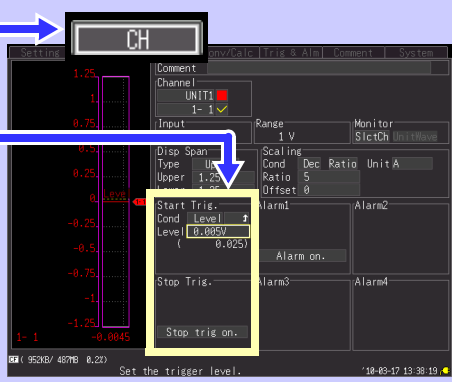

Setting Trigger Criteria

Using Level Triggering

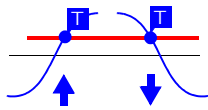

Enter the signal level threshold at which to start or stop measuring, and whether triggering occurs on the upslope or downslope of the input signal.

Recording starts or stops when the signal crosses the specified threshold. The level value is an instantaneous (not rms) value.

Levels can be confirmed on the level monitor or on the Waveform/Numerical screen. Make trigger settings on the [CH] screen of the displayed channel.

See: "Key Setting Procedure" (p .101)

- 1 Select [Level] as the start/stop trigger type.
- 2 Select the input signal rising (↑) or falling (↓) edge setting option.
 Setting options: (* : default setting)
 ↑* Measurement starts (or stops) when the signal crosses the threshold on the upslope (rising edge ↑).
 ↓ Measurement starts (or stops) when the signal crosses the threshold on the downslope (falling edge ↓).
- 3 Set the input signal level at which to start or stop measuring.

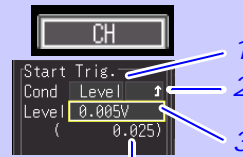

When scaling is enabled, the scaled value is also displayed.

Default setting: 0

Ranges and Trigger Resolution

Channels	Input type	Range	Resolution
1-1 to 4-15	Voltage	10 mV f.s	0.01 mV
		20 mV f.s	0.02 mV
		100 mV f.s.	0.1 mV
		200 mV f.s.	0.2 mV
		1 V f.s.	0.001 V
		2 V f.s.	0.002 V
		10 V f.s.	0.01 V
		20 V f.s.	0.02 V
		100 V f.s.	0.1 V
		1-5 V f.s.	0.01 V
	Temperature (thermocouple and RTD)	100°Cf.s	0.1°C
		500°Cf.s.	0.5°C
		2000°Cf.s.	2°C
	Humidity	Resistance	100% rh f.s
10 Ω f.s.			0.01 Ω
P1 to P8	Count	20 Ω f.s.	0.02 Ω
		100 Ω f.s.	0.1 Ω
		200 Ω f.s.	0.2 Ω
		-	1 c
	Revolve	-	1 r/s

5.1 Triggering Measurement Start and Stop

Using a Window Trigger

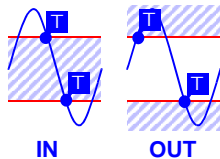

An input signal level “window” within which recording will (or will not) occur can be defined by upper and lower threshold levels. You can select whether measurement starts or stops when the input signal level enters (In) or exits (Out) of this window. Upper and lower thresholds can be verified in the monitor or on the Waveform screen. When scaling is enabled, the scaled threshold values are displayed.

Make trigger settings on the [CH] screen of the displayed channel.

See: "Key Setting Procedure" (p .101)

- 1 Select [Window] as the start/stop trigger type.
- 2 Select trigger timing (window type).
Setting options: (* : default setting)

In*	Trigger when the input signal level enters the window defined by the upper/lower thresholds.
Out	Trigger when the input signal level exits the window defined by the upper/lower thresholds.

- 3 Enter the upper/lower threshold value.

Scaled values are displayed when scaling is enabled.

5.1 Triggering Measurement Start and Stop

Using Logic Triggering

Logic triggering is available when Logic is selected for pulse input channels (p. 61). Triggering is controlled by the signal state and combination of logic input signal channels. Select a trigger pattern (1, 0, or X) and AND/OR combining logic so that triggering occurs when the combined criteria are satisfied. Make trigger settings on the [CH] screen. See: "Key Setting Procedure" (p .101)

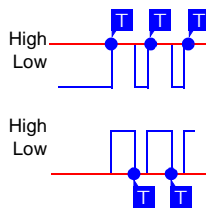

- 1 Select the trigger signal combining logic. (Select [OR] or [AND] as the start/stop trigger type.)**

Setting options: (* : default setting)

OR*	Triggering occurs when the state of any one of the trigger signals matches the set pattern.
AND	Triggering occurs only when the states of all of the trigger signals match the set pattern.

- 2 Select the triggering state (pattern) for each pulse channel. (This setting applies to the pulse input channels selected for trigger logic.)**

Setting options: (* : default setting)

X*	Signal is ignored.
0	Triggering can occur when the signal switches from High to Low.
1	Triggering can occur when the signal switches from Low to High.

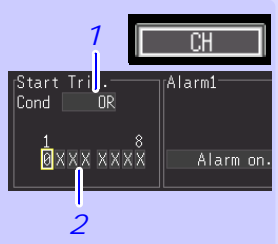

Selecting Triggering Criteria (Trigger Source)

Enable the trigger function (set to On), select recording start/stop timing, and set trigger criteria.

Make these settings on the [Trig & Alm] screen.

See: "Key Setting Procedure" (p .101)

NOTE

If trigger settings have been made on the [CH] screen, skip steps 1 and 2. (The settings in steps 1 and 2 are interlinked with those on the [CH] screen.)

- 1 Select the [CH] or [Trig&Alm] Screen.
- 2 Enable triggering [On].
- 3 Select measurement start/stop timing.
 Setting options: (* : default setting)

Start*	Start recording according to Start Trigger criteria.
Stop	Stop recording according to Stop Trigger criteria.
Start/Stop	Start and stop recording according to the Start and Stop Trigger criteria, respectively.

(Start and stop triggers can be set for each channel independently.)
- 4 Select trigger combining logic.
 Setting options: (* : default setting)

OR*	Triggering occurs when any one of the specified trigger source criteria is met. (includes external trigger signal)
AND	Triggering occurs only when all of the specified trigger source criteria are met. (includes external trigger signal)

Trig & Alm

Trigger/Alarm	Trig Source
Trig Func On	Start OR
Timing Start	Stop OR

Trig Source	Ext trig
Start OR	Start Off
Stop OR	Stop Off

See: "Using External Triggering" (p .106)

Triggering Criteria

To apply a trigger when the upslope (↑) of the waveform crosses zero volts:

Trigger: Level
 Level: 0 V
 Slope: ↑

When [AND] is selected

No triggering occurs initially if trigger criteria are already met when measurement starts. Before triggering can occur, trigger criteria must first become invalid once.

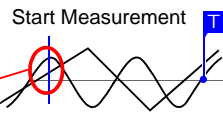

[AND]

One waveform has crossed above 0 V as the other crosses on the upslope

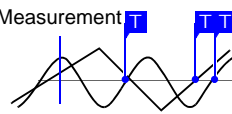

[OR]

Either waveform crosses 0V on the upslope

Using External Triggering

To use an external signal as a trigger source, make the following settings.

- 1 Connect the external trigger signal to the HiLogger's EXT.TRIG external control terminal. (See the connection procedure on P.43)
- 2 Press SET to open the [System] screen.
- 3 Set the [External Trig In] to [Trigger] (default setting).
- 4 Press SET to open the [Trig & Alm] screen.
- 5 Set triggering criteria (p. 105).
- 6 Select the slope for the [Ext trig] [Start] and [Stop] settings.
 Select whether triggering occurs on the trigger signal's upslope or downslope.
 Setting options: (* : default setting)

Off*	External triggering is disabled.
↑	Triggering occurs on the upslope from Low (0 to 1.0 V) to High (2.5 to 5.0 V).
↓	Triggering occurs on the downslope from High (2.5 to 5.0 V) to Low (0 to 1.0 V), or when the EXT TRIG terminal is connected to a GND terminal.

 This setting is forced Off when [External Trig In] is set to [Event] on the [System] screen.
- 7 Confirm whether triggering is provided by an external signal or by shorting the EXT.TRIG terminal to GND (only when [Ext trig] is set to [↓]).

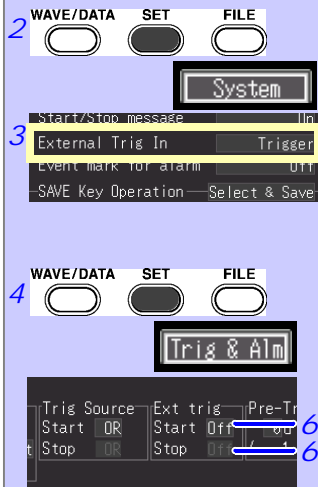

5.1 Triggering Measurement Start and Stop

Trigger Input Signals

Voltage range	HIGH level: 2.5 to 5.0 V, LOW level: 0 to 1 V
Pulse width	HIGH period: 1 ms or greater, LOW period 1 ms or greater
Maximum input voltage	DC0 to 10 V

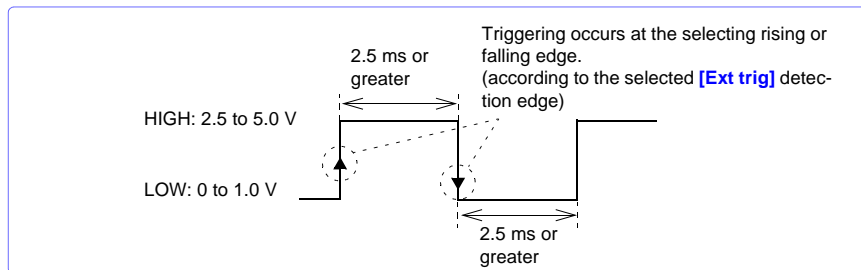

5.1 Triggering Measurement Start and Stop

Setting Criteria for Pre-Trigger Measuring (Pre-Trig)

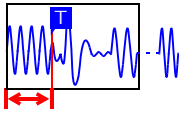

When trigger timing is set to **[Start]** or to **[Start/Stop]**, not only the waveform following the trigger can be measured, but a specified span of the waveform before triggering as well.

However, when trigger timing is set to **[Stop]**, pre-trigger settings are disabled.

Make these settings on the **[Trig & Alm]** screen.

See: "Key Setting Procedure" (p .101)

[Pre-Trig]

Set the amount of time to record before each trigger event.

To also measure the waveform after triggering, the recording time must be set longer than the pre-trigger time. (See "Pre-Trigger and Recording Times" below.)

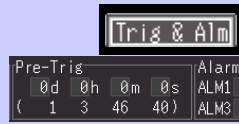

The maximum settable time is displayed.



Increment/decrement by 1
(when the recording interval is longer than 2 seconds, increment/decrement by one recording interval)



Increment/decrement by 10
(when the recording interval is longer than 10 seconds, increment/decrement by one recording interval)

NOTE

HiLogger pre-trigger time can be set up to 99 days. Logger Utility settings of 100 days or more are reduced to 99 days when transferred to the HiLogger.

Difference between [Waiting for pre-trigger] and [Waiting for trigger]

When measurement is started, the specified pre-trigger length is recorded. This period is indicated as the **[Waiting for pre-trigger]**.

After the specified pre-trigger length has been recorded, the period indicated as **[Waiting for trigger]** continues until a trigger occurs.

During the **[Waiting for pre-trigger]** interval, trigger criteria are ignored.

Pre-Trigger and Recording Times

When the recording time is shorter than pre-trigger time

Measurement ends with the trigger event

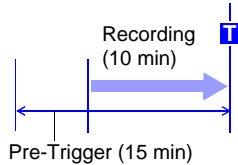

When the recording time is longer than pre-trigger time

Measuring before and after triggering. Ends when the recording time has elapsed

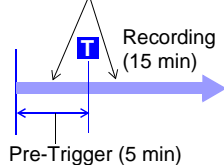

5.2 Alarm Output

You can enable beep tones and an alarm output signal (for external use) for each input channel by setting its alarm criteria.

External alarm output requires connection to the external control terminals. See "9.3 Alarm Signal Output (Alarm Output)" (p. 163) for details.

Checking Alarm Criteria

Alarm output status is displayed on the [Wave+Value], [Value+Cmnt], and [Value] Waveform/Numerical screens.

The screenshot shows the 'PLS&ALM' screen with a table of alarm criteria and their status. The table is as follows:

Channel	Criteria	Status	Output
P. 1	97 c	Yellow*	ON
P. 2	0 c	Green	OFF
P. 3	0 c	Green	OFF
P. 4	0 c	Green	OFF
P. 5	0 c	Green	OFF
P. 6	0 c	Green	OFF
P. 7	0 c	Green	OFF
P. 8	0 c	Green	OFF

Alarm	Status	Output
ALM1	Yellow*	ON
ALM2	Green	OFF
ALM3	Green	OFF
ALM4	Green	OFF

1 Select the [Wave+Value], [Value+Cmnt], or [Value] Waveform/Numerical screen.

2 Select [PLS & ALM] with the UNIT key. Put the cursor here and press ENTER to directly select which input unit to display.

Channel alarm status

- ALM1 status indicator
- ALM2 status indicator
- ALM3 status indicator
- ALM4 status indicator

- Yellow*: alarm criteria are satisfied
- Green: alarm criteria are not satisfied
- *: When [Alarm Hold] is enabled (set to [On]), the indicator remains yellow because the criteria remain satisfied (until measurement is finished).

Alarm output status (ALM)

- Red: alarm signal output active
- Green: alarm signal output inactive

5 Chapter 5 Specifying Criteria for Measurements

110

5.2 Alarm Output

■ Some alarm settings are available on the Waveform/Numerical screens.

On the [Gauge+Wave] Waveform/Numerical screen, the alarm beeper, alarm hold, and [ALARM CLR] (when alarm hold is enabled) can be set. (Alarm hold can only be set when measurement is stopped.)

The image shows a screenshot of a device's menu system. At the top, there are three buttons: 'WAVE/DATA', 'SET', and 'FILE'. A blue arrow points from the 'FILE' button to a 'Gauge+Wave' screen. On this screen, a blue arrow points to a 'PLS&ALM' button. A second blue arrow points from the 'PLS&ALM' button to a detailed inset menu. The inset menu shows 'Wave PLS&ALM' with options for 'Set Item', 'Channel', 'ALM1', 'Alarm Hold', and 'Buzzer'. The 'Alarm Hold' is currently set to 'On' and 'Buzzer' is set to 'Off'. At the bottom of the inset is an 'ALARM CLR' button.

1 Select the [Gauge+Wave] Waveform/Numerical screen.

2 Select [PLS & ALM] with the UNIT key.
Put the cursor here and press ENTER to directly select which input unit to display.

- **Hold**
Selects whether to reset or hold (latch) alarm outputs while measuring. (can only be set when measurement is stopped)
- **Buzzer (beeper)**
Enables and disables the alarm beeper. (can be set while measuring or not)
- **ALARM CLR**
When alarm hold is enabled, put the cursor here and press ENTER to clear the alarm manually.
An alarm can be cleared only when the alarm criteria are no longer met.

Alarm Settings

Select alarm input channels on the [CH] screen, and specify alarm criteria on the [Trig & Alm] screen.

See: "Key Setting Procedure" (p .101)

WAVE/DATA SET FILE

Select the [CH] Screen.

1. Configuring Alarm Output

- 1 Select [PLS&ALM].
- 2 Choose an alarm channel (ALM1 to ALM4) for output, and select the checkbox [].
 To enable ALM1 to ALM4 outputs, on the setting screen for channels 1-1 to 4-5 and P1 to P8, move the cursor to [Alarm on.], select the checkbox [], and press ENTER. ALM1 to ALM4 are enabled and disabled together. ALM1 cannot be enabled by itself.
- 3 Select whether to reset or hold (latch) alarm outputs while measuring.
 This setting is also available on the [Gauge+Wave] Waveform/Numerical screen (p. 110).
 Setting options: (* : default setting)

Off*	Disable the alarm output signal when alarm criteria are no longer met.
On	Hold the alarm output active state until measurement is finished.
- 4 Enable or disable the alarm beeper by the [Buzzer] setting.
 This setting is also available on the [Gauge+Wave] Waveform/Numerical screen (p. 110).
 Setting options: (* : default setting)

Off*	The HiLogger will not sound an audible beep during alarm signal output.
On	The HiLogger will sound an audible beep during alarm signal output.

2. Setting Alarm Criteria for Each Channel

- 1 Choose the input unit and channel(s) to serve as alarm criteria, and select the checkbox [].
- 2 (If alarm criteria settings are disabled) Select [Alarm on.].*
 *ALM1 to ALM4 outputs are all enabled [].

↓ (continues on next page)

- Alarm hold and beeper can also be set on the Waveform/Numerical screen ([Gauge+Wave] display).
- To stop the alarm beeper while measuring, set the beeper to [Off] in the ALM channel settings on the Waveform/Numerical screen.

*: Displayed when the box is not checked in step 2 of procedure 1.

When the selected channel is in any of UNIT1, 2, 3, 4, CALC1, or 2, and when PLS&ALM is set to integration or revolution input

3 Configure Alarm Criteria.

Setting options: (* : default setting)

Off*	Disable alarms for this channel.
Level	Trigger an alarm when the input reaches a specified level.
Window	WindowTrigger an alarm when the input transition through upper and lower limits.

4 (If using a [Level] setting)

Setting options: (* : default setting)

↑*	Sound an alarm when the value is bigger than the level value set.
↓	Sound an alarm when the value is smaller than the level value set.

(When [Window] is selected)

Setting options: (* : default setting)

In*	Sound an alarm when the value is within the range of the window (upper and lower values) set.
Out	Sound an alarm when the value is outside the range of the window (upper and lower values) set.

When the selected channel's PLS&ALM setting is for Logic input

5 Configure Alarm Criteria.

Setting options: (* : default setting)

OR*	An alarm is output when any one of the criteria match the set pattern.
AND	An alarm is output only when all of the criteria match the set pattern.

6 Set the alarm pattern.

Setting options: (* : default setting)

X*	Signal is ignored.
0	An alarm is output when the signal switches from High to Low.
1	An alarm is output when the signal switches from Low to High.



(continues on next page)

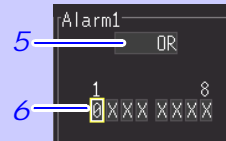
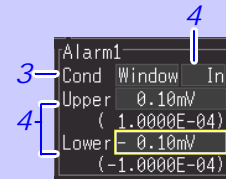
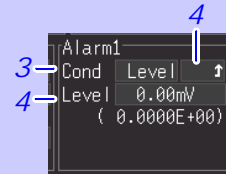

WAVE/DATA SET FILE **Select the [Trig & Alm] Screen.**

3. Selecting Combined Alarm Output Criteria

Setting options: (* : default setting)

- OR*** Alarm output occurs when the alarm criteria specified for any alarm-enabled channel are satisfied.
- AND** Alarm output occurs only when the alarm criteria for every alarm-enabled channel are satisfied.

Trig & Alm

Alarm Source
ALM1 OR ALM2 OR
ALM3 OR ALM4 OR

Trigger/Alarm
Trig Func On
Timing Start
Alarm On

If [Alarm] is set to [Off], change it to ([On]).

■ An alarm can be output when thermocouple burn-out is detected.

1 Select the [Trig & Alm] Screen. WAVE/DATA SET FILE

2 Select a [Pulse Logic Alarm] unit.

3 Set [Alarm at burn out.] to [On].
This setting causes alarm output to be generated whenever a broken wire is detected, regardless of other alarm condition settings and alarm source settings [AND, OR].

The screenshot shows the 'Trig & Alm' screen with the following settings:

- Setting: Pulse Logic Alarm
- Unit: UNIT 1
- Batch Proc: Start, Stop, Alarm1, Alarm2, Alarm3, Alarm4
- ALM1, ALM2, ALM3, ALM4: Each has a checkmark and a color-coded indicator.
- Alarm at burn out.: On, Off, Off, Off
- Trigger/Alarm: Trig Source (Start OR), Ext trig (Start Off), Pre-Trig (0d 0h 0m 0s), Alarm Source (ALM1 OR ALM2 OR ALM3 OR ALM4 OR)
- Timing: Start, Stop, OR
- Alarm: On

5.3 Confirming All Trigger and Alarm Criteria Settings

You can view and change trigger and alarm criteria settings for all channels on the [Trig & Alm] screen.

Select [Batch Proc] to initialize settings and to copy trigger and alarm settings from channels 1-1, 2-1, 3-1, 4-1, P1, and W1 to W16 to any other channel. Copied settings include level, slope, and threshold values.
 See: "3.9 Viewing and Editing with the All-Channel Settings List" (p. 74)

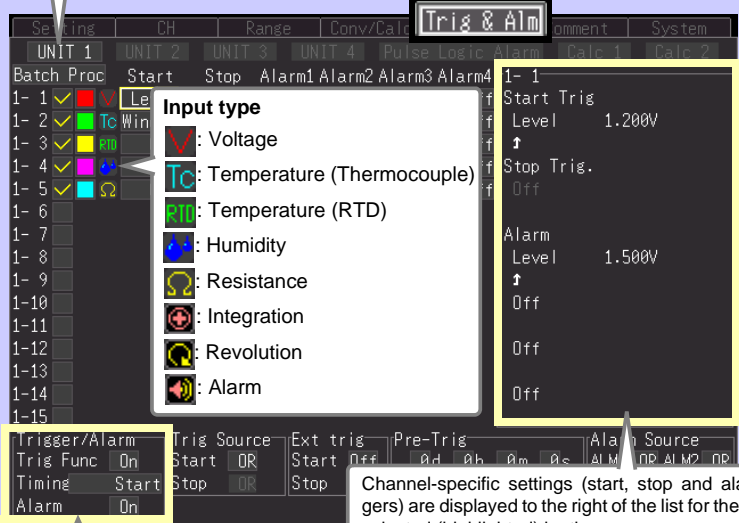

Trig Func (p. 105)
 Select On to enable triggering.
Alarm
 Select On to enable alarms.

Channel-specific settings (start, stop and alarm triggers) are displayed to the right of the list for the channel selected (highlighted) by the cursor.

Press **ENTER** to display the dialog at the right for the cursor-selected channel. Trigger and alarm criteria for the selected channel can be set.



5.4 Periodic (Timer) Measurements

Make these settings to record at a specific time. Recording can be set to repeat at specific intervals between the set start and stop times. Before setting, confirm that the HiLogger clock is set to the correct time. If not, reset the clock on the [System] screen (p. 158).

- 1 Select the [Setting] Screen.
- 2 Move to a setting item.
- 3 Open the setting options for the item to be set.
- 4 Select from the listed options
- 5 Apply

Key Setting Procedure

Change 1's digit

Change 10's digit

- 1
- 2
- 3
- 4

Setting Procedure

- 1 Set the [Timer] to [On]. (default setting: Off)
- 2 Enable (set to [On]) the desired timer setting items.
Setting options:

Start	Set the recording start time.
Stop	Set the recording stop time.
Interval	Set the recording repetition interval. This setting is enabled on when [Repeat] is set to [On] (p. 52).
- 3 Set the year, month, day, hour, minute and second for the start or stop time.
To enter the current time as the start or stop time, select the clock mark (⌚) and press ENTER.
- 4 (When [Interval] is set to [On]) Set the amount of time (days, hours, minutes and seconds) between recording repetitions.
- 5 Press START.
[Wait Timer] will be displayed at the bottom of the waveform screen.

116

5.4 Periodic (Timer) Measurements

Setting Example

To record daily from 9:00 to 17:00 for one month beginning 1/1/2008,
Repeat Recording: On, Timer: On

			(YY-M-D)	(H:M:S)
Start time setting (9:00 on 01/01/2008)	Start	On	08 -1 - 1	9: 0: 0
Stop time setting (17:00 on 01/31/2008)	Stop	On	08 -1 -31	17: 0: 0
Time from one measurement start to the next (one day)	Inter- val	On	1	0: 0: 0
Recording time* (8 hours from 9:00 to 17:00)				8: 0: 0

*: [Cont] recording should be disabled (Off). 08-1-1 08-1-1 08-1-2
9:00 17:00 9:00



5.5 Measurement with Trigger and Timer Functions

Measurement operation depends on the trigger, timer, repeat recording (On/Off), and recording time settings.

○ Press **START** ● Press **STOP** ⌚ Timer start/stop time T Trigger criteria match

Cont.	Trig-ger	Timer	Repeat: Off	Repeat: On
Off	Off	Start		
Off	Off	Stop		
Off	Off	Stop		
Off	Off	Start/Stop		(Repeat Recording: same as Off)
Off	Start	Off		
Off	Stop	Off		

5

Chapter 5 Specifying Criteria for Measurements

5.5 Measurement with Trigger and Timer Functions

○ Press START ● Press STOP ⌚ Timer start/stop time T Trigger criteria match

Cont.	Trig-ger	Timer	Repeat: Off	Repeat: On
Off	Start/Stop	Start/Stop	<p>Recording time Measuring Start of Measurement End of Measurement</p>	<p>Recording time Recording time Measuring Start of Measurement Dead time End of Measurement</p>
A start trigger occurs after the timer start time, and a stop trigger occurs before the timer stop time				
On	Stop	Off	<p>Measuring Start of Measurement End of Measurement</p>	<p>Measuring Start of Measurement Dead time End of Measurement</p>

About Dead time

After a recording length has elapsed, some “dead time” is needed for internal processing before recording can resume. No measurement occurs during the dead time. So to avoid information loss, split data into files at a specified interval by enabling continuous recording (**[Repeat]**), and selecting **[Split Save]** for auto saving.

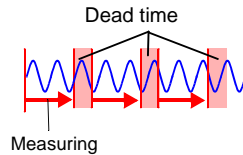

5.6 Trigger Setting Examples

Following are examples of typical trigger settings.

Intended Measurement Objective	Ref. No. (next table)
Acquire data from when you press START until you press STOP	No.1
Acquire data for one minute after each time you press START	No.2
Acquire data at one-minute intervals for sixty minutes after you press START	No.3
When the temperature measured on CH1 exceeds 500°C, acquire data until you press STOP .	No.4
Acquire data from when you press START until the temperature measured on CH1 exceeds 500°C.	No.5
Acquire data from when the temperature measured on CH1 exceeds 500°C until it drops below 300°C.	No.6
Acquire data whenever the temperature measured on CH1 exceeds 500°C, until it drops below 300°C.	No.7
Acquire data for only one minute from when the temperature measured on CH1 exceeds 500°C.	No.8
Acquire data for one minute before and after the time when the temperature measured on CH1 exceeds 500°C.	No.9
Acquire data from 9:00 to 17:00 on 6/17/2008.	No.10
Starting at 9:00 on 6/17/2008, acquire data for 24 hours/day, for one month.	No.11
Starting on 6/17/2008, acquire data continuously from 9:00 to 17:00 daily for one month.	No.12
Starting on 6/17/2008, acquire data for one hour at 9:00, 15:00, 21:00, and 3:00 daily for one month.	No.13

120

5.6 Trigger Setting Examples

No.	[Setting] Screen					[Trig & Alm] Screen			[CH] Screen	
	Timer	Repeat	Record time	Split Save	Trig Func	Timing	Trig Source	Pre-Trig	Start Trig.	Stop Trig.
1	Off	Off	[Cont.] On	Off	Off	-	-	-	-	-
2	Off	Off	[Cont.] Off 0h: 1min: 0s	Off	Off	-	-	-	-	-
3	Off	Off	[Cont.] Off 1h: 0min: 0s	On [Split Length] 1 min	Off	-	-	-	-	-
4	Off	Off	[Cont.] On	Off	On	[Start]	[Start] OR	-	[Cond] Level↑ [Level] 500°C	-
5	Off	Off	[Cont.] On	Off	On	[Stop]	[Stop] OR	-	-	[Cond] Level↑ [Level] 500°C
6	Off	Off	[Cont.] On	Off	On	[Start/ Stop]	[Start] OR [Stop] OR	-	[Cond] Level↓ [Level] 500°C	[Cond] Level↓ [Level] 300°C
7	Off	On	[Cont.] On	Off	On	[Start/ Stop]	[Start] OR [Stop] OR	-	[Cond] Level↓ [Level] 500°C	[Cond] Level↓ [Level] 300°C
8	Off	Off	[Cont.] Off 0h: 1min: 0s	Off	On	[Start]	[Start] OR	-	[Cond] Level↑ [Level] 500°C	-
9	Off	Off	[Cont.] Off 0h: 2min: 0s	Off	On	[Start]	[Start] OR	1 m	[Cond] Level↑ [Level] 500°C	-
10	[Start] On 08-6-17 9:0:0 [Stop] On 08-6-17 17:0:0 [Interval] Off	Off	[Cont.] On	Off	Off	-	-	-	-	-
11	[Start] On 08-6-17 9:0:0 [Stop] On 08-7-17 9:0:0 [Interval] Off	Off	[Cont.] On	On [Split Length] 1 day	Off	-	-	-	-	-
12	[Start] On 08-6-17 9:0:0 [Stop] On 08-7-17 9:0:0 [Interval] On 1 0:0:0	On	[Cont.] Off 8h: 0min: 0s	Off	Off	-	-	-	-	-
13	[Start] On 08-6-17 9:0:0 [Stop] On 08-7-17 9:0:0 [Interval] On 0 6:0:0	On	[Cont.] Off 1h: 0min: 0s	Off	Off	-	-	-	-	-

Saving & Loading Data

Chapter 6

HiLogger data can be saved to removable storage (optional CF card or USB flash drive). The CF card is designated drive "A:" and the USB flash drive is drive "B:".

See: "2.6 Inserting a CF Card or USB Flash Drive (when saving data)" (p. 45)

Data saved (in binary format) to removable storage can be reloaded into the HiLogger.

6.1 About Saving and Loading Data

When saving data, a folder named HIOKI_LR8400 is created, and files are stored in the folder as follows.

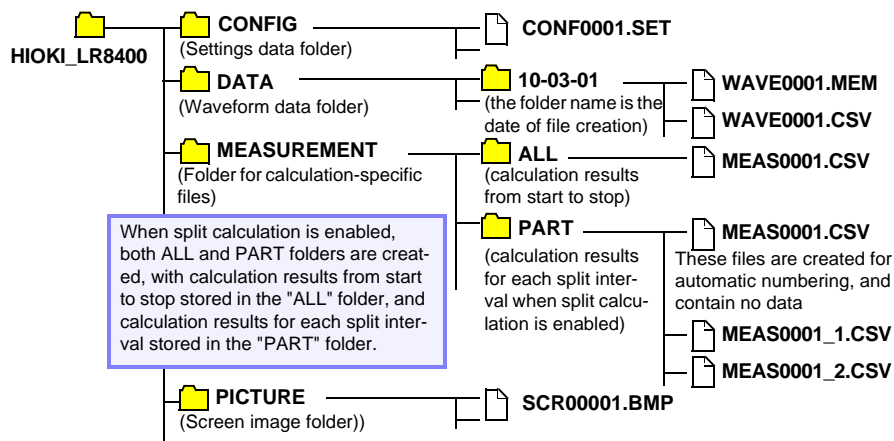

6

Chapter 6 Saving & Loading Data

122

6.1 About Saving and Loading Data

O: Available/ x: Not Available

File Type	File Format	Folder Name	File Name*5 (Auto-numbered from 1)	Save		Load	
				Auto	Manual	HiLogger	PC
Setting Data	Binary	CONFIG	CONF0001.SET	x	O	O	x
Waveform Data*1	Binary	DATA\date)*4 (e.g.: 08-07-30)	WAVE0001.MEM	O	O	O	O
	Text *2	DATA\date)*4 (e.g.: 08-07-30)	WAVE0001.CSV *6	O	O	x	O
Numerical Calculation Results	Text *2	MEASUREMENT	MEAS0001.CSV *7	O	O	x	O
Captured Screen Image	BMP *3	PICTURE	SCR00001.BMP	x	O	O	O

*1: Save waveform data in **binary format** if you intend to view it later in the HiLogger or on a PC with the supplied Logger Utility program. Waveform data and some measurement-related settings data are saved.

To save a waveform partially, specify a period by using A/B cursors before saving (p. 90).

When the scaling function is set to enable, scaling information as well as raw data (non-converted data) in binary format are saved. When the data saved in the storage devices is loaded, the converted data will be displayed. The raw data can also be observed by resetting the scaling function to OFF.

*2: When opening a CSV file in a spreadsheet program, note that the number of rows that can be loaded at one time is limited (p. A8).

*3: BMP Format: This is a standard Windows graphics format. These files can be handled by many graphics programs.

*4: Date (YY-MM-DD) folders are automatically created inside the DATA folder.

*5: When saved manually. See "Appendix 3 File Naming" (p. A8) for file naming details.

*6: The TXT file extension is applied except when [\[Separator:Comma\]](#) is selected on the [\[System\]](#) screen.

*7: When creating calculation-specific files, an underbar and a serial number (_n) is appended to the file name, e.g., MEAS0001_1.CSV, MEAS0001_2.CSV, etc.

NOTE

Depending on file size and CF card capacity, each folder can store over 1,000 files. However, the file screen display is limited to a maximum of 1,000 files. Also, as more files are created, more time is needed to start and stop recording. We recommend setting measurement criteria so that the number of saved files stays below 1,000 whenever possible.

What happens to data in a power outage?

Data in internal memory is retained for about 30 minutes after power-off. If power is off for more than 30 minutes, the data is lost. Also, when Auto-Resume (p. 152) is enabled, measurement resumes automatically when power is restored, so previous measurement data is deleted. To avoid data loss in such cases during long-term measurement, we recommend the following settings to prepare for power outages.

Preparation for power outages during long-term measurements

- Connect the (optional) battery pack before starting (p. 30)
Measurement can continue on battery power when mains power is lost.
- Configure Auto Save beforehand (save [\[Waveform\(realtime\)\]](#), P.125)
Data is periodically saved to removable storage. The HiLogger includes a large-value capacitor to provide power to save the most recent data and close the files when power fails.



If power is lost within about three minutes after power-on, files on the removable storage may be corrupted, and the device could be damaged. If a damaged storage device is used, files may fail to close within the allotted time, and data may be lost. When [\[File Protection:High\]](#) is selected on the System screen, storage media is not recognized for three minutes after power-on, during which files may be inaccessible and could become corrupted.
See: "File Protection Level Setting" (p.153)

Although [\[CSV\(realtime\)\]](#) saving is possible, data is saved only as text, so waveforms cannot be displayed later by reloading into the HiLogger or by application programs. Note that the recording interval setting is limited (p. 125).

6.2 Saving Data

Basically, three methods are available for saving.

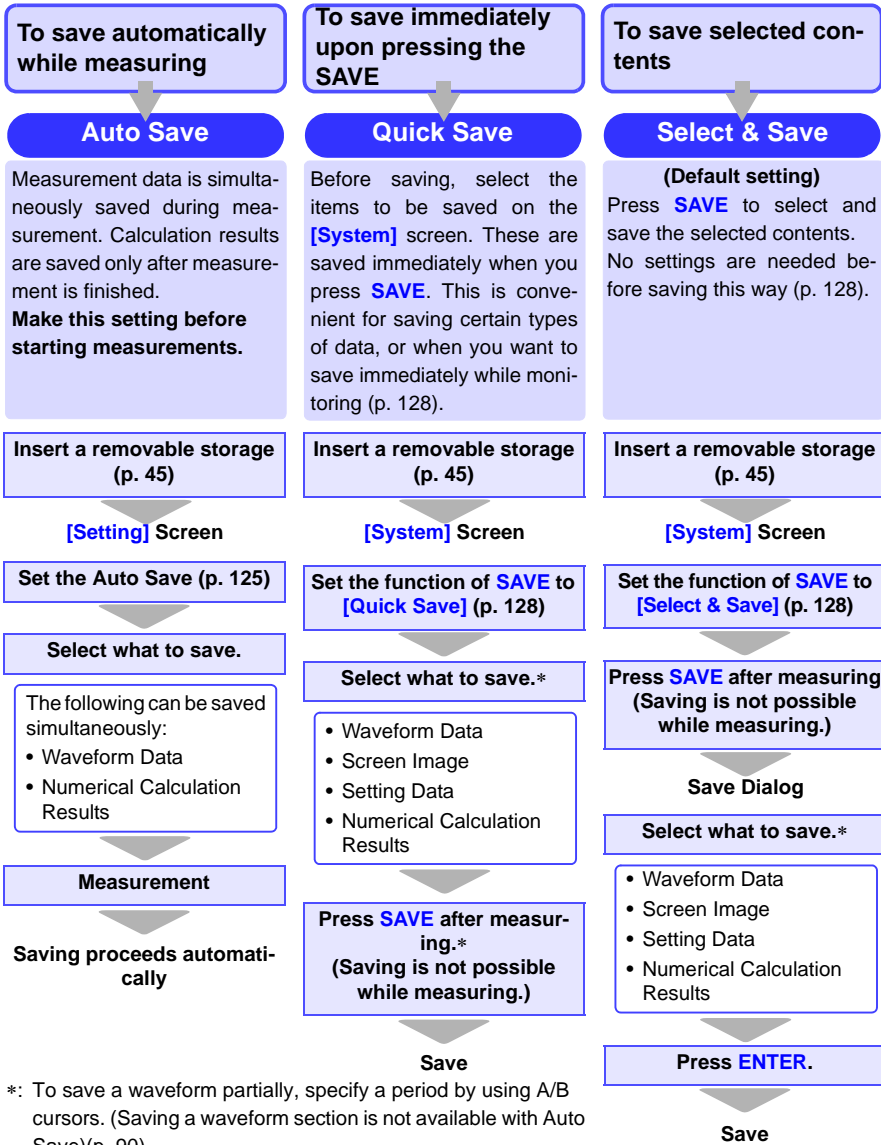

Automatic Saving (Waveform Data and Numerical Calculation Results)

When auto save is enabled before starting measurement, data can be automatically saved to removable storage during or after measurement.

The following types of measurement data can be auto-saved.

Saved Data	Settings	File Extension	Description
Waveform Data Only	Waveform (realtime)	.MEM	During measurement, waveform data is saved in binary format. Conversion to text (CSV) format can be done later, so we suggest selecting Waveform(realtime) for typical operation.
	CSV (realtime) *2	.CSV*3	During measurement, waveform data is saved in text format. Saved data cannot be reloaded into the HiLogger or by the Logger Utility. However, this format is ideal for loading into spreadsheets like Excel.
Calculation Results Only *1	Calc (post meas.)	.CSV*3	Calculation results are saved after measurement. When [Repeat] recording is enabled (On), each measurement's calculation results are appended to the file. When [Split Calculation] is enabled (On), calculation results are appended at each save interval.
Both Waveform Data and Calculation Results*1	Waveform +Calc	.MEM, .CSV*3	Waveform data is saved in binary format during measurement, and calculation results are saved at the end of measurement.
	CSV + Calc*2	.CSV*3, .CSV*3	Waveform data is saved in text format during measurement, and calculation results are saved at the end of measurement. Saved data cannot be reloaded into the HiLogger.

- *1. Calculation must be enabled before starting measurement (p. 143).
- *2. The recording interval setting is limited for [CSV(realtime)] and [CSV+Calc] according to the number of channels used.
 For up to 15 channels (using U1-1 to U1-15), the recording interval must be longer than 50 ms
 For up to 30 channels (using U2-1 to U2-15), the recording interval must be longer than 100 ms
 For up to 45 channels (using U3-1 to U3-15), the recording interval must be longer than 200 ms.
 For up to 60 channels (using U4-1 to U4-15), the recording interval must be longer than 200 ms.
 To perform waveform calculations, the recording interval must be longer than 500 ms.
 (Pulse, logic, and alarm channels do not impose such limits.) Also, when opening a CSV file in a spreadsheet program, the number of rows that can be loaded is limited.
- *3. The TXT file extension is applied except when [Separator:Comma] is selected on the [System] screen.

Setting Procedure

- Select the [Setting] Screen.
- Move to a setting item.
- Open the setting options for the item to be set.
- Select from the listed options.
- Apply

Displays an estimate of the remaining time available on the attached CF card/ USB flash drive.

1 Select the contents to be saved.

Setting options: (* : default setting)

Off*, **Waveform(realtime)**, **CSV(realtime)**, **Calc (post meas.)**, **Waveform + Calc**, **CSV + Calc**

If **[Off]** is selected, skip steps 2 to 5.

If **[Calc (post meas.)]** is selected, skip steps 4 and 5.

2 Specify the waveform file name (if needed).

See: "3.7 Entering Titles and Comments (as needed)" (p. 71)

If left blank, file names are created automatically.

See: "Appendix 3 File Naming" (p. A8)

3 Select the removable storage priority (CF card or USB flash drive)**4 Select whether to delete while saving.**

Select the desired operation when removable storage becomes full while saving.

Setting options: (* : default setting)

Off* Saving ends when the removable storage is nearly full.

On When the free capacity of the removable storage reaches a certain minimum size, waveform files are deleted, oldest first. If deletion is not possible, saving stops. Delete while saving does not apply to numerical calculation files.

5 Select whether to save data into multiple files ("Split Save").

Select single (per measurement) or multiple (timed) file creation.

Setting options: (* : default setting)

Off* Creates a single file per measurement.

On Specify the save timing (split time). (Figure at right) A new data file is created for each split time (span).

Ref Time Specify the reference time (Ref Time) and split time (Split Length). (Figure at right) A new file is created for each split time (span), starting from the reference time.

6 Press START to start measuring.

After measurement, the data is automatically saved to removable storage (p. 121).

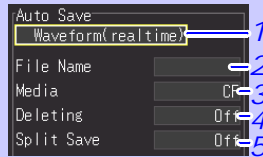

The horizontal axis setting is limited when auto saving waveforms (p. 68).

■ With **[Split Save]** set to **[On]**

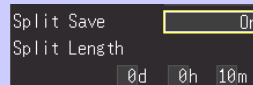

Also set the **[Split Length]**. Days (0 to 30), Hours (0 to 23), Minutes (0 to 59)

■ With **[Split Save]** set to **[Ref Time]**

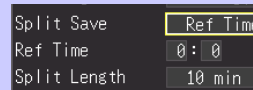

Also set the following items:
[Ref Time]: 0:0 to 23:59
[Split Length]: 1, 2, 5, 10, 15, 20, 30 minutes, 1, 2, 3, 4, 6, 8, 12 hours, 1 day

Before measurement starts, "Sync fixed time" is displayed until the next measurement time synchronizes with the reference time.

Before starting to measure, confirm that Auto Save is configured correctly, and that the removable storage is properly installed.

Replacing Removable Storage During Real-Time Saving

During real-time saving, removable storage can be replaced without interrupting measurement. This procedure describes replacing a USB flash drive.

Move the cursor to [EJECT].

Execute

Move the cursor to [Unmount USB memory.].

Execute

Move the cursor to [Yes].

Execute

Execute
A "Replaceable" message appears

Remove the USB flash drive (p. 46).

Insert a formatted removable storage.
Measurement data acquired while the device was removed is automatically written.*
See: Formatting: (p. 47)
Insertion: (p. 45)

Right bottom of the screen

Media removing.
Unmount CF.
Unmount USB memory. Cancel

Media removing.
Do you want to remove the USB memory?
Yes No

After "Replaceable" appears next to the media icon, please replace the media.
Yes

Bottom of the screen

USB replaceable

When both a CF card and USB flash drive are installed and either is removed, the save destination automatically switches to the remaining media.

6

Chapter 6 Saving & Loading Data

- NOTE**
- If a storage device is not replaced within two minutes after selecting "Yes" in the "Do you want to remove the USB memory/CF card?" confirmation dialog, data may overflow internal memory and be lost.
 - If a storage device is replaced during real-time saving, data is saved to a new file.
 - If measurement ends while the removable storage is ejected, even if a removal storage is then inserted, the remaining data is lost. In that case, when connected to a LAN, data can be read from the HiLogger via the HTTP function. See "10.4 Remote Measurement with the HTTP Server Function" (p. 188).

Saving Manually (Waveform Data, Screen Images, Numerical Calculation Results)

Press **SAVE** to save data.

NOTE

- Internal memory capacity limits saving to the most recent eight million data points. If you need to save more data points, enable real-time auto-saving beforehand.
- Saving can only occur when measurement stops. Saving is not possible while measuring (both waveform data and screen images).

Setting Procedure

The diagram illustrates the setting procedure through a series of steps and a screenshot of the device's settings menu.

- Select the [System] Screen.** (Indicated by a blue arrow pointing to the 'System' tab in the screenshot.)
- Move to a setting item.** (Indicated by a blue arrow pointing to the 'SAVE Key Operation' item in the screenshot.)
- Open the setting options for the item to be set.** (Indicated by a blue arrow pointing to the 'Select & Save' option in the screenshot.)
- Select from the listed options.** (Indicated by a blue arrow pointing to the 'Select & Save' option in the screenshot.)
- Apply** (Indicated by a blue arrow pointing to the 'Apply' button in the screenshot.)

The screenshot shows the 'System' settings menu with the following items:

- Start Backup: Off
- File Protection: Low
- Backlight Saver: Off
- Brightness: 100%
- Display: Black
- Beep Stop: On
- Time Dis: On
- Language: English
- Start/Stop message: On
- External Trig In: Trigger
- Event message for alarm: Off
- Version: V 1.23
- Serial No.: 106299981
- Decimal Mark: Dot
- Separator: Comma
- N-Calc. Data Saving: Single file
- Date set format: Comment
- Clock Setting: Time
- Initialize: USB Drive Mode
- Self-Test: KEY/LED, LCD, ROM/RAM, CF card, USB Memory, Unit Information

The 'SAVE Key Operation' is highlighted in yellow and set to 'Select & Save'.

First select the saving method.
Choose **[Select & Save]** or **[Quick Save]**.

SAVE Key Settings

Setting options: (* : default setting)

- | | |
|---------------------------|---|
| Select & Save* | Pressing SAVE displays a dialog. Select the type of contents to be saved, and save the data. |
| Quick Save | Pressing SAVE saves data according to the settings on the [System] screen. |

See p. P.130 when selecting **[Select & Save]**, and P.129 for **[Quick Save]**.

When you select [Quick Save] (to save data upon pressing SAVE)

Settings are displayed. Select contents to be saved.

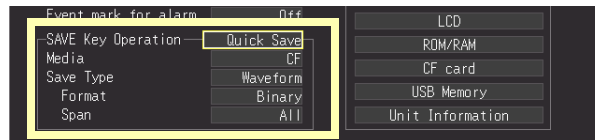

Media Select the priority save destination when [Quick Save] is selected.
Setting options: (* : default setting)

CF*	Save to the CF card first
USB Memory	Save to the USB flash drive first

Save Type Select the type of data to save.
Setting options: (* : default setting)

Waveform*	Save waveform data.
Screen Image	Save screen image.
Setup File	Save setting configuration data.
Calc Results	Save numerical calculation results.

Calculation must be configured before saving numerical calculation results (p. 143).

Format (When [Waveform] is selected) Select the data format.
Setting options: (* : default setting)

Binary*	Select this format to be able to reload the saved data into the HiLogger, or so that it can be loaded into the Logger Utility program.
CSV	Select this format to save the data as a text file. This format is ideal for loading into spreadsheet programs like Excel.

Data saved in CSV format cannot be reloaded into the HiLogger or Logger Utility program. Fortunately, data saved in binary format can be later converted to text (CSV) format with the HiLogger or Logger Utility.

Span (When [Waveform] is selected) Select the time span to be saved.
Setting options: (* : default setting)

All*	Save all measured waveform data.
A-B	Save waveform data between A/B cursors.
Start-A	Save waveform data from the start of measurement to cursor A.
Start-B	Save waveform data from the start of measurement to cursor B.
A-End	Save waveform data from cursor A to the end of measurement.
B-End	Save waveform data from cursor B to the end of measurement.

- Before saving a partial waveform, specify the span to be saved (p. 90).
- When a save span is specified for calculation, the results are saved for the specified span.

Executing a Save

Press **SAVE** to immediately save data according to current settings.

When [Select & Save] is selected (to save after selecting setting contents)

Settings are the same as for Quick Save.

See: For details about the type, format, and span, see P.129 , and for setting procedures, see P.131 .

Waveform Data

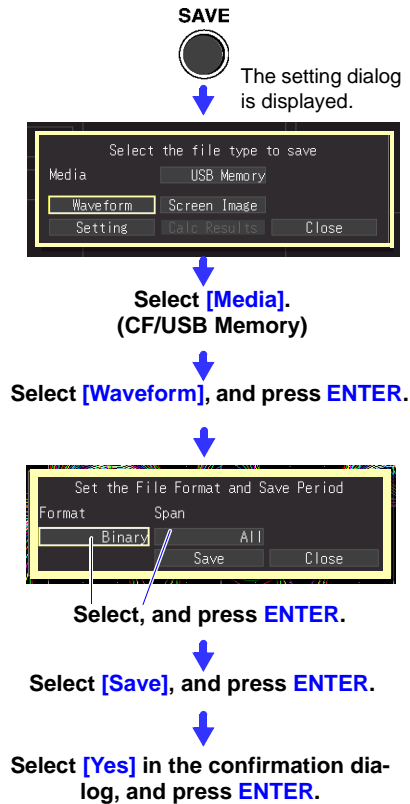

Before saving a partial waveform, specify the span to be saved (p. 90).

Screen Images and Numerical Calculation Results

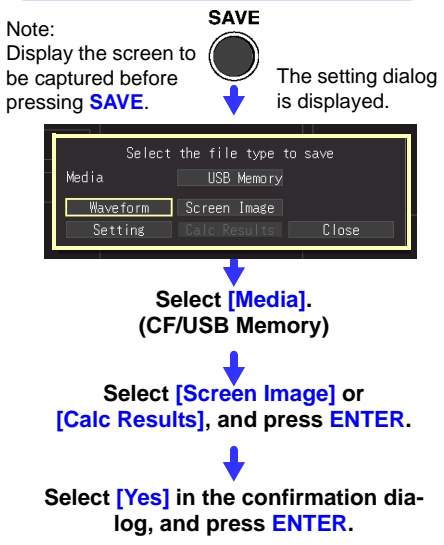

- Numerical calculation must be configured in order to save calculation results (p. 143).
- When a save span is specified for calculation results, the results are saved for the specified span.

To Save a Setting Configuration

Setting configurations can be saved as data files and later reloaded into the HiLogger when you need to make more measurements with the same settings. Up to ten setting configurations can be saved to internal memory, and more can be stored on the removal storage device.

1 Select the **[Setting]** Screen.

2 Select **[Save Set]**
Apply
The Save dialog appears.

3 Select whether to save to **HiLogger memory, CF card, or USB flash drive.**
Apply

4 (When **[Memory]** is selected)
Select **[Save]** for the configuration instance (No.) to save.
Enter a comment as needed (p. 71).
Apply

(When [CF Card], or [USB memory] is selected)
Setting configuration files are automatically named CONFnnnn.SET in a folder named [HIOKI_LR8400]-[CONFIG] (p. 121).

6 Chapter 6 Saving & Loading Data

Comments entered on the **[Comment]** screen are displayed here.

See: To reload a setting configuration (p. 132)

6.3 Loading Data on the HiLogger

Previously stored binary waveform data, captured screen images and saved setting configurations can be reloaded into the HiLogger (p. 121).

Loading a Setting Configuration

Setting configurations saved in the HiLogger's memory or on a removable storage can be reloaded.

1 Select the **[Setting]** Screen.

2 Select **[Load Set.]**.

Apply

The loading dialog appears.

3 Select whether to load from HiLogger memory, CF card, or USB flash drive.

Apply

4 (If you selected **[Memory]**)

Select **[Load]** for the configuration you want to load.

Apply

(If you selected **[CF Card]**, or **[USB memory]**)

Select the configuration file to load. (CONFnnnn.SET)

Apply

HiLogger settings are reconfigured to those in the loaded configuration file.

Setting

Range	Conv./Calc.	Trig & Alm.	Comment	System
Title comment			Load Set.	Save Set.
battery test				
Interval	50ms	Numerical Calc.	On	Auto Save
				Yram(realtime)
1s/DIV	Calc2	Maximum		CF
Repeat	Calc3	Minimum		Media
0:off	Calc4	Off		Deleting
Cont	Calc5	Off		Split Save
	Calc6	Off		Ref Time
				Ref Time
				Split Length
				10 min
Record time				Approx. savable time
d h m s				CF : 3 Day 2 Hour
0 1: 0: 0				
Max 0 3: 53: 0				

Load from where?

Memory CF Card USB memory

Close

Setting List

No.	Name	Type	Size
No. 1			
No. 2	Empty		
No. 3	Empty		

When Loading from HiLogger Memory

The list of configurations stored in HiLogger memory is displayed.

Interval: 20ms
Title: []

A: /HIOKI_LR8400/CONFIG

No.	Name	Type	Size
0001	CONF0001.SET	Set	197.0K
0002	CONF0002.SET	Set	197.0K

When Loading from removable storage

Configuration files stored in the [HIOKI_LR8400]-[CONFIG] folder on the removable storage are displayed.

See: To Save a Setting Configuration: (p. 131)

Setting configurations saved to removable storage can be reloaded from the File screen (as described on the next page).

Automatically Loading Configuration Data (Auto Resume)

Setting configuration data saved as a file named STARTUP.SET in the [HIOKI_LR8400] - [CONFIG] folder can be automatically reloaded at power-on.

When setting configurations are stored on both CF card and USB flash drive, the CF card has priority.

When **[File Protection: High]** is selected on the System screen, Auto Setup is not available.

Loading Waveform Data and Screen Images

Saved binary waveform data and screen images can be reloaded in the HiLogger.

1 **WAVE/DATA** **SET** **FILE**
Select the File Screen.
 The contents of the removable storage are displayed.

2 **Select a file to load**

After selecting a folder by pressing **ENTER**, select **[Change]** in the displayed control dialog box.

Displays the child folder. (Viewing folder contents)
 Displays the parent folder.

3 **Select [Load].**

Apply
 The control dialog box appears.

Apply

When loading waveforms)

When the amount of data in a file to be loaded exceeds the internal memory capacity, you can specify a data point (number) at which to start loading (**[Top of data num]** in fig. below). The loadable data size shows the **[Readable data num]** (maximum number of data points) that can be loaded. This setting is not needed if the data to be loaded will fit in internal memory. Select **[OK]** to load the data.

File name: AUTO0001.MEM
 Trigger Time: *10-03-17 11:42:12
 Data num: 98
 Saved Ch: UNIT1, UNIT2, UNIT3, UNIT4, PULSE, LOGIC, ALARM, CALC1

Readable data num: 26214
 Top of data num: (0 ~ 8)
 Scope of data re: *10-03-17 11:42:12 ~ *10-03-17 11:42:16



Annotations:
 - Waveform data file name
 - Waveform data start trigger time
 - Number of data points in the file
 - Channels saved in waveform data to be loaded (Analog, Pulse, and Alarm)
 - Maximum number of data points that can be loaded (to internal memory)
 - Settable range of offset to first data point
 - Times of first and last data points to be loaded



6.4 Data Management

You can manage data stored on a removable storage in the HiLogger.

- Format removable storage (p. 47)
- Load a file (when the file is selected) (p. 132)
- Move displayed folders (when the folder is selected) (p. 135)
- Delete data (p. 136)
- Rename files and folders (p. 137)
- Copy data (p. 138)
- Sort files (p. 139)

Switching removable storage

1    **Select the File screen**
CF card contents* are displayed.

2    **Press FILE again.**
USB flash drive contents are displayed.
Press FILE to toggle between drive A (CF card) and B (USB flash drive).

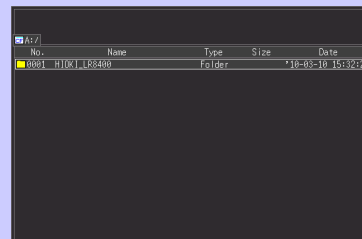





No.	Name	Type	Size	Date
0001	H10K_L68480	Folder		*10-03-10 15:32:26

*: When only a USB flash drive is inserted in the HiLogger, its contents are displayed.
The drive cannot be switched.

Viewing Folder Contents and the Parent Folder

1    **Select the File screen**
CF card contents* are displayed.

2   **Select a folder to view.**
 **View child folder (view contents of the currently highlighted folder)**
(press **ENTER** and select **[Change]** in the displayed control dialog box)
 **Displays the parent folder.**

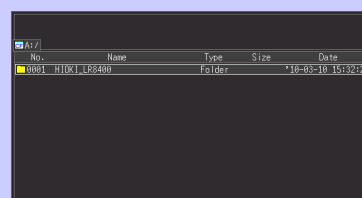

No.	Name	Type	Size	Date
0001	H10K_L68480	Folder		*10-03-10 15:32:26

*: When only a USB flash drive is inserted in the HiLogger, its contents are displayed.

- Another drive can be selected when the root folder is displayed.
- The path name may have up to 128 characters.

Deleting Data

Folder and files on the removable storage can be deleted.

1  **Select the File Screen.**

2  **Select a folder or a file to delete.**

 **Apply**

3  **Select [Delete].**

 **Apply**

A confirmation dialog appears. Select **[Yes]** and press **ENTER** to delete.

 **What if the file I want to delete is not displayed?**

See: "Switching removable storage" (p.135)

See: "Viewing Folder Contents and the Parent Folder" (p.135)

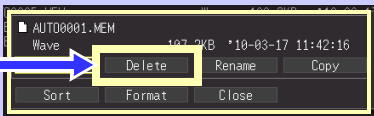

NOTE

- To protect against inadvertent data loss, the HIOKI_LR8400 and DATA folders cannot be deleted. If you need to delete one of these folders, rename it first.
- Read-only files can only be deleted with a PC.

Renaming Files and Folders

Folders and files on a removable storage can be renamed. File names may consist of up to 26 regular characters.

1
WAVE/DATA SET FILE



Select the File Screen.

2

Select the file or folder to rename.

↓

Apply

3

Select [Rename].

↓

Apply

The character entry dialog appears.
Enter the new file name (the same way as when entering a comment) (p. 71).

A confirmation dialog appears.
Select [Yes] and press the ENTER to apply the new name.

What if the file I want to rename is not displayed?

See: "Switching removable storage" (p .135)

See: "Viewing Folder Contents and the Parent Folder" (p .135)

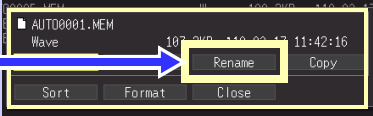

Copying Data

Files and folders can be copied between a CF card and USB flash drive.

1  Select the File Screen.

2  Select a folder or file to copy.

↓

 Apply

3  Select [Copy].

↓

 Apply

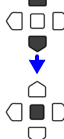
4  Select the copy destination folder.

↓

 Apply

A confirmation dialog is displayed. Select [Yes] and press ENTER to execute the copy operation.

 **What if the file I want to copy is not displayed?**

See: "Switching removable storage" (p .135)

See: "Viewing Folder Contents and the Parent Folder" (p .135)

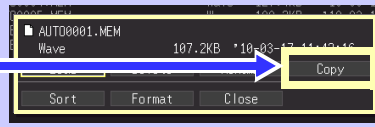







NOTE

- Folder copying is supported for up to eight hierarchical levels. Folders more than eight levels deep cannot be copied.
- A file cannot be copied if one with the same name already exists at the destination.

Sorting Files

Files can be sorted in ascending or descending order according to a selected sort key.

- 1  **Select the File Screen.**
- 2  **Apply**
The control dialog box appears.
- 3  **Select [Sort].**
- 4  **Apply**
Select the key on which to sort.
- 5  **Apply**
Execute the sort.
Files are redisplayed sorted in ascending or descending order. (Press to toggle ascending/descending order)
- 6  **Finish**

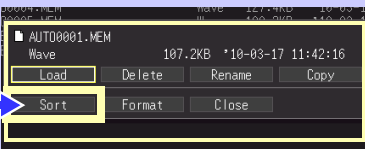
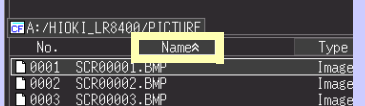
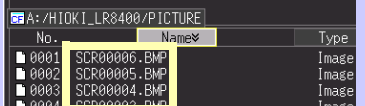
Reordering also applies to non-displayed files.
(In the last figure above, all (six) files are displayed in descending order by file name.)

6.5 Transferring Data to a PC (USB Drive Mode)

Data saved to a CF card can be transferred to a PC using the supplied USB cable. Before connecting the USB cable to the HiLogger, set the communications interface setting to USB (p. 170), and select "USB Drive Mode" on the HiLogger.

NOTE

- Refer to the Logger Utility Instruction Manual (on the supplied CD) to observe data using the Logger Utility program on a PC (p. 187).
- Data cannot be read from a USB flash drive in the HiLogger. To load files from a USB flash drive removed from the HiLogger, insert it into a USB slot on the PC.
- USB Drive Mode is not available with Windows 2000.

Select the USB Drive Mode

1 **WAVE/DATA** **SET** **FILE** → **System**
Select the **[System]** Screen.

2 ↓
Select **[USB Drive Mode]**.

↓
Apply
A confirmation dialog appears.

3 ↓
Select **[Yes]**.

↓
Apply
The USB Drive Mode is enabled.

No other HiLogger operations are available when the USB Drive Mode is enabled. Also, HiLogger communications with the supplied Logger Utility program are disabled.
See: "To exit USB Drive Mode" (p. 141)

4 Connect the USB cable (p. 141).

Connecting the USB Cable

Compatible OS: Windows XP, Vista, or 7



- Do not eject the CF card or pull out the USB cable during data transfer. Doing so would prevent proper data transfer.
- The HiLogger and PC should be connected to the same earth ground. If grounded separately, potential difference between the ground points can cause malfunctions or damage when connecting the USB cable.

Before connecting the USB cable to the HiLogger, select the USB Drive Mode on the [System] screen. Otherwise, the HiLogger's CF card cannot be accessed.

1 Orient the USB cable plug properly, and insert it into the receptacle.

2 Connect the other end of the cable to a USB port on the PC. The PC should recognize the HiLogger as a removable disk when the cable is connected.

To exit USB Drive Mode

1 Click the Safely Remove Hardware (🗑️) icon in the Windows notification area.

2 Click the appropriate line "Safely remove USB Mass Storage Device? Drive(H:)" where H is the drive letter that Windows assigned to the HiLogger.

3 When "Safe to remove hardware" appears, click [X] or [OK].

4 Disconnect the USB cable.

5 Turn the HiLogger off and back on.

6

Chapter 6 Saving & Loading Data

Numerical Calculations/Waveform Calculations Chapter 7

7.1 Calculate Average, Maximum, Minimum, and Etc.

Calculations can be applied to measured data. Six types of calculation are available, four of which can be applied at the same time.

See: Refer to "7.2 Numerical Value Calculation Expressions" (p. 148) for details of the calculation methods. You can specify the measurement time span over which calculations are to be applied (p. 147).

Types of calculations

- Average value Average value of waveform data
- Peak value Peak-to-peak value of waveform data
- Maximum value Maximum value of waveform data
- Minimum value Minimum value of waveform data
- Time to maximum value Time elapsed from the start of measurement to the maximum value
- Time to minimum value Time elapsed from the start of measurement to the minimum value

Two methods are available for applying calculations, as follows.

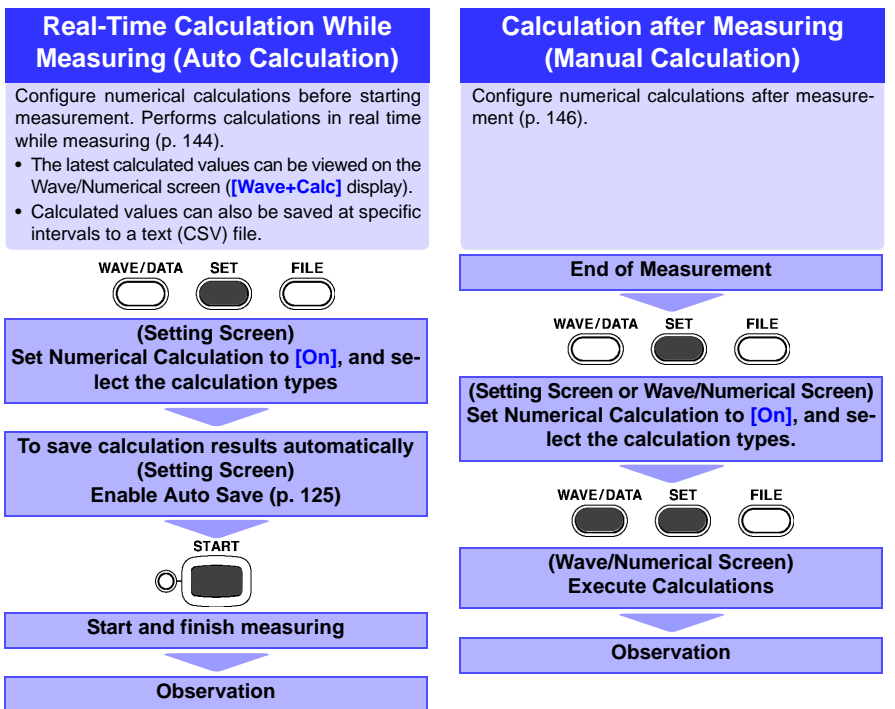

7.1 Calculate Average, Maximum, Minimum, and Etc.

Key Setting Procedure

1 Select the [Setting] Screen.

2 Move to a setting item.

3 Open the setting options for the item to be set.

4 Select from the listed options.

5 Apply

The screenshot shows the 'Settings' screen with a yellow box highlighting the 'Numerical Calc.' section. The 'On' option is selected. The 'Average' calculation type is chosen for Calc1.

Real-Time Calculation While Measuring (Auto Calculation)

Calculations are automatically performed in real time while measuring.

1 Select [On].

2 Select numerical calculation types.

Setting options: (* : default setting)

Average, P-P, Maximum, Minimum, Time to Max, Time to Min, Off*

To record calculated values at specified intervals (split calculations), perform steps 3 and 4.
 (To record calculated values only from measurement start to the present, skip to step 5.)

(continues on next page)

7.1 Calculate Average, Maximum, Minimum, and Etc.

3 Configure Auto Save.
 Select **[Calc(post meas.)]**, **[Waveform + Calc]**, or **[CSV + Calc]**.
 When **[Waveform(realtime)]** or **[CSV(realtime)]** is selected, the settings in step 4 are not available.

4 Select a split-calculation (timing) method.
 Setting options: (* : default setting)

Off*	Save only the last calculation results.
On	Save calculation results at a fixed interval. Set the calculation interval equal to the [Length] .
Ref Time	Save calculation results at a fixed interval. Set the calculation time to the [Split time] and [Split Length] .

5 Start measuring.

6 Select **[Wave+Calc]** display on the Wave/Numerical screen.
 Numerical calculation results are displayed.

Calc1 The results of the selected calculation (no.) are displayed.

UNIT1 The results of the selected input unit are displayed. Press **UNIT** to switch the display to another input unit.



Usual **Split**

Select whether to display calculations from the start of measurement (normal), or the latest calculations after each interval (split value).
 When split calculation is disabled, the split value is displayed as "- -".

7.1 Calculate Average, Maximum, Minimum, and Etc.

Calculation after Measuring (Manual Calculation)

After measuring, configure and execute calculations.

- 1 Start and finish measuring. 
- 2 Select the [Wave+Calc] display on the Wave/Numerical screen.
- 3 Select [On]. 
- 4 Select any of [Calc1] to [Calc6]. (Default setting: [Calc1])
- 5 Select the calculation type.
Setting options: (* : default setting)
Average, P-P, Maximum, Minimum, Time to Max, Time to Min, Off*
- 6 Select [Exec], and execute. 
Numerical calculation results are displayed.

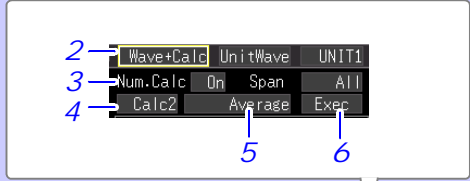

Calc2 The results of the selected calculation (Calc no.) are displayed.

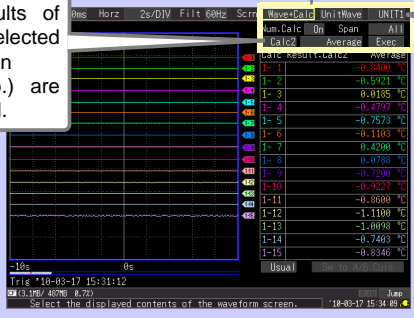

UNIT1 The results of the selected input unit are displayed. Press **UNIT** to switch the display to another input unit.

Make these settings on the [Setting] screen. After setting, select [Wave+Calc] display on the Wave/Numerical screen, and select [Exec] to execute calculations.

7.1 Calculate Average, Maximum, Minimum, and Etc.

Apply Calculations to a Specific Time Span (Manual Calculation Only)

After measuring, calculation can be applied to a specified time span. Make any other calculation settings before specifying the calculation time span (P.146 , 1 to 5).

- 1 Press **SCROLL/CURSOR** to display A/B cursors.
- 2 Press the left/right **SCROLL/CURSOR** keys to move the A/B cursors to specify the time span.
See: Changing the cursor to move (p. 90)
- 3 Select **[Sw to Calc]**.
Apply
- 4 Move to a **[Span]** item.
Open the setting options for the item to be set.
Select the calculation time span.
See the table at the right for setting choices
Apply
- 5 Select **[Exec]**.
Apply
The results of calculations are displayed.

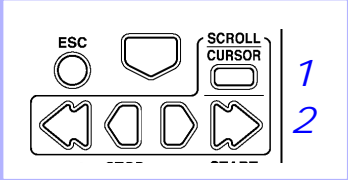
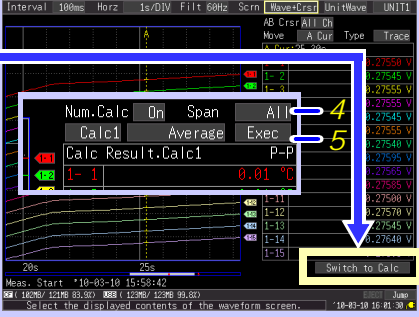
Setting options: (* : default setting)	
All*	The entire acquired waveform
A-B	The time span between cursors A and B
Start-A	From the start of the acquired waveform to cursor A
Start-B	From the start of the acquired waveform to cursor B
A-End	From cursor A to the end of the acquired waveform
B-End	From cursor B to the end of the acquired waveform

7.2 Numerical Value Calculation Expressions

<p>Average</p>	$AVE = \frac{1}{n} \sum_{i=1}^n di$	<p>Obtains the average value of waveform data. <i>AVE</i>: Average value <i>n</i>: Data count <i>di</i>: Data on channel number <i>i</i></p>
<p>Peak Value (P-P)</p>		<p>Obtains the value of the difference (peak-to-peak value) between maximum and minimum values of waveform data.</p>
<p>Maximum Value</p>		<p>Obtains the maximum value of waveform data.</p>
<p>Minimum Value</p>		<p>Obtains the minimum value of waveform data.</p>
<p>Time to maximum value</p>		<p>Acquires the time (s) elapsed from the start of recording to maximum value. When there are two or more maxima, this value is the first to occur.</p>
<p>Time to minimum value</p>		<p>Acquires the time (s) elapsed from the start of recording to minimum value. When there are two or more minima, this value is the first to occur.</p>
<p>Interval Calculation (Auto Calc only, P.144)</p>		<p>When [Split Save] is enabled ([On] or [Ref Time]), calculation results are saved at the specified interval.</p> <p>When [On]: Set the [Split Length]. Calculation results for the specified time span are automatically saved.</p> <p>When [Ref Time]: Set the [Ref Time] and [Split Length]. Calculation results starting from the reference time are automatically saved for the specified time span.</p>

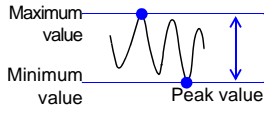
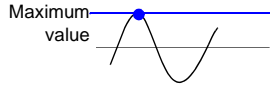
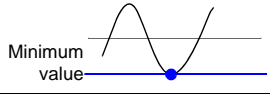
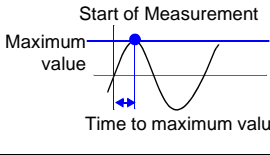
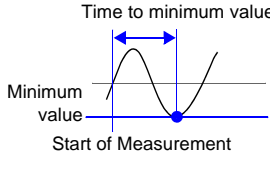
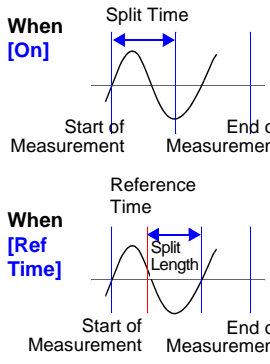
7.3 Waveform Calculations

Coefficient a x [CH A] (x, ÷, +, or -) coefficient b x [CH B] + coefficient c

(CH A and CH B may be any input channels' measurement data, selectable from CH1-1 to 4-15, P1 to P8, or waveform calculation result channels W1 to W29 (reused as inputs, as long as the channel number is smaller than number of the final calculation result channel)). For example, to obtain results on W3, [CHA] and [CHB] can be set to W1 and W2, respectively.)

The above formula is set up beforehand, calculation result waveforms are displayed on the Waveform screen while measuring, and calculated values can be saved. Up to 30 calculation result waveform channels (W1 to W30) are available at once.

NOTE

Waveform calculations cannot be performed after measurement.

Key Setting Procedure

1 Select the [CH] Screen.

2 Move to a setting item.

Open the setting options for the item to be set.

Select from the listed options.

Apply

UNIT selects the input unit and **CHAN** select the channel to be set.

7

Chapter 7 Numerical Calculations/Waveform Calculations

- 1 Select [CALC1] or [CALC2] and channel W1 to W30, then select the check box () to enable calculation.
- 2 Set the [calculation formula], and press ENTER.
The coefficient setting dialog is displayed.
- 3 Enter or select coefficient a, CH A, coefficient b, CH B, coefficient c, and the measurement units, and press ENTER.

Channel

CALC1	<input checked="" type="checkbox"/>
UNIT1	<input type="checkbox"/>
UNIT2	<input type="checkbox"/>
UNIT3	<input type="checkbox"/>
UNIT4	<input type="checkbox"/>
PLS&ALM	<input type="checkbox"/>
CALC1	<input checked="" type="checkbox"/>
CALC2	<input type="checkbox"/>

calculation form

```
( 1.0000E+00
+ ( 1.0000E+00
+ 0.0000E+00
```

W 1 : Input formula.

a	Ch A	Ope.	b	Ch B	c	Unit
1.0000E+00	1- 1	+	1.0000E+00	1- 1	+	0.0000E+00 V

Coefficient setting dialog
See: "Numerical Value Entry" (p .67)

Increment/decrement by 1, change sign (+/-)

Select setting field

The calculation formula can be entered on the [Conv/Calc] screen. The calculation formula entered for channel W1 can be copied to other channels (p. 74).

- 1 Select the [Conv/Calc] Screen.
- 2 Move the cursor to [Calc 1] or [Calc 2].
- 3 Select channel W1 to W30.
The coefficient setting dialog is displayed.
- 4 Enter or select coefficient a, CH A, coefficient b, CH B, coefficient c, and the measurement units, and press ENTER.

Conv/Calc

Calc 1 Calc 2

calculation fo

W 1 (1.0000E+00

W 2

W 1 : Input formula.

a	Ch A	Ope.	b	Ch B	c	Unit
1.0000E+00	1- 1	+	1.0000E+00	1- 1	+	0.0000E+00 V

Coefficient setting dialog

Increment/decrement by 1, change sign (+/-)

Select setting field

System Environment Settings

Chapter 8

Settings affecting the clock, **SAVE** key operation and self testing are made from the [System] screen.

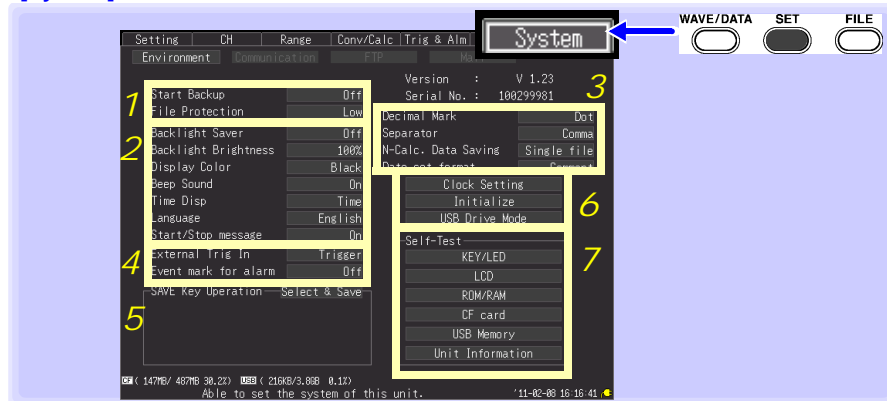

1	Operation Related Settings	<ul style="list-style-type: none"> Specify operating behavior when recovering from power outages (Auto-Resume) (p. 152) Set the file protection level (p. 153)
2	Screen and Key Related Settings	<ul style="list-style-type: none"> Set backlight power saving (p. 153) Set backlight brightness (p. 154) Select black or white screen background (p. 154) Enable or disable the beeper (p. 154) Set the horizontal axis (time value display) (p. 155) Select display language (p. 155) Set start/stop confirmation message display (p. 155)
3	CSV File Saving	<ul style="list-style-type: none"> Select CSV file data decimal and separator characters (p. 156) Select the sort order for numerical calculation results (p. 156) Setting How to Handle Date Data Stored in CSV Files (p. 157)
4	External Trigger Input	<ul style="list-style-type: none"> Select the external trigger function (p. 157) Set alarm event marking (p. 157)
5	Saving (SAVE key)	<ul style="list-style-type: none"> Select the saving method for SAVE (p. 128) Select the type of data to save* (p. 129) Select save formats* (p. 129) Select the time span to save* (p. 129) <p>*: Set when [Quick Save] is selected.</p>
6	System-Related Settings	<ul style="list-style-type: none"> Set the clock (p. 158) Reinitialize the HiLogger(p. 159) Transfer data (p. 140)
7	Self Testing	<ul style="list-style-type: none"> KEY/LED test (p. 160) LCD test (p. 160) ROM/RAM test (p. 160) CF card test (p. 160) USB flash drive test (p. 160) Input unit test (p. 160)

Key Setting Procedure

1 WAVE/DATA SET FILE → **System**

2 Select the [System] Screen.

Move to a setting item.

Open the setting options for the item to be set.

Select from the listed options.

Apply

(Screenshot of System settings screen showing various options like Start Backup, File Protection, Backlight Saver, etc.)

8.1 Operation Settings

Using the Auto-Resume Function (Resume After Power Restoration)

If a power outage or other power loss causes an interruption in recording (while the LED on the left side of **START** is lit), you can automatically resume recording when the power is restored. If you are using triggers, the triggers are restored to the **[Waiting for trigger]** state.

NOTE

When Auto-Resume is enabled, measurement data that was in internal memory before the outage is lost when measurement resumes. To retain measurement data from before an outage, disable Auto-Resume (set to Off).

To retain measurement data from before an outage and resume measuring automatically afterwards, enable Auto Save (p. 125).

Start Backup (Auto-Resume)

Setting options: (* : default setting)

Off*	Do not use the Auto-Resume Function.
On	Use the Auto-Resume Function.

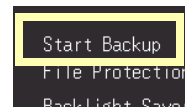

File Protection Level Setting

If power is lost within about three minutes after power-on, files on the removable storage may be corrupted, and the device could be damaged. These risks can be avoided by setting the file protection level to [High].

File Protection

Setting options:(* : default setting)

Low*	Although removable storage is recognized and ready for recording immediately upon power-on, if power is lost within about three minutes after power-on, files on the removable storage may be corrupted, and the device could be damaged.
High	Removable storage is not recognized for three minutes after power-on (when data could be corrupted or the device damaged).

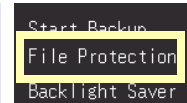

NOTE

Auto-Setup is not available when [High] is selected (p. 132).

8.2 Screen Key Operation Settings

Enabling and Disabling the Backlight Saver

A backlight saver can be activated after a specified number of minutes during which no operation key is pressed. The backlight saver turns off the backlight of the LCD, prolonging the lifetime of the backlight by turning it off when not needed. To deactivate the backlight saver, press any key. The operating screen appears again.

Backlight Saver

Setting options:(* : default setting)

Off*	Disables the backlight saver function. The operating screen is always displayed.
1 min, 2 min, 3 min, 4 min, 5 min	The backlight saver is activated if the specified time is exceeded.

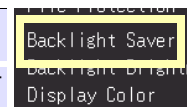

- Be aware that power is still consumed even when the backlight is off, so be sure to turn the HiLogger power switch off when not in use.
- While the backlight saver is active, the HiLogger's measuring state is still indicated by the LED.

8.2 Screen Key Operation Settings

See: "Key Setting Procedure" (p .152)

Adjust Backlight Brightness

Backlight brightness can be selected from four levels. Lower brightness settings provide longer battery operating time.

Backlight Brightness When the [Backlight Brightness] setting is selected, pressing **ENTER** repeated cycles through the four brightness levels.

Setting options:(* : default setting)

100%*, **70%**, **40%**, **25%** (four-step brightness setting)

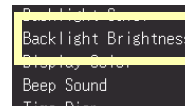

Selecting Black or White Screen Background

The screen background can be set to black or white.

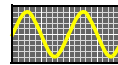

Black Back-

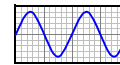

White Back-

Display Color (Background Color)

Setting options:(* : default setting)

Black* Make background black.

White Make background white.

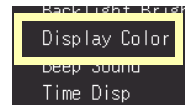

Enabling or Disabling the Beeper

The beeper can be set to sound when an error occurs.

Beep Sound (Beeper)

Setting options:(* : default setting)

On* Emit a beep sound on error messages (error and warning displays).

Off Do not emit beep sound.

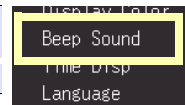

NOTE

When the alarm beeper is enabled, no beep sounds when a warning or error occurs while measuring.

Selecting the Horizontal (Time) Axis Display

Select the display method for the horizontal axis at the bottom of the screen. This setting also determines the time display for data saved in CSV format.

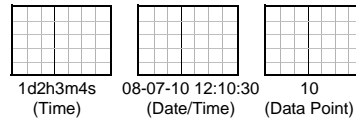

Time Disp (Time Value Display)

Setting options:(* : default setting)

Time*	Displays the time span from the start of measurement. If triggering is enabled, the displayed time span is from the last trigger event.
Date	Displays the date and time every ten divisions.
Data Pts	Displays the number of data points from the start of measurement. If triggering is enabled, the displayed data points begin from the last trigger event.

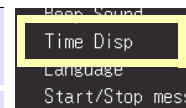

Selecting the Display Language

Select the display language.

Language

Setting options:(* : default setting)

English*	Display in English.
Japanese	Display in Japanese.
French	Display in French

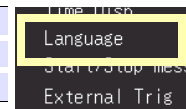

Display of Start/Stop Confirmation Messages

To help avoid operator errors, confirmation messages can be displayed when measurement is manually started or stopped.

Start/Stop message (Start/Stop Confirmation Messages)

Setting options:(* : default setting)

Off	Confirmation messages are not displayed. Pressing START and STOP start and stop measurement immediately.
On*	Confirmation messages are displayed. To start or stop measurement, move the cursor to "Yes" and press ENTER .

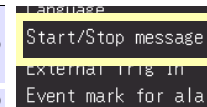

8.3 CSV File Saving Settings

See: "Key Setting Procedure" (p.152)

CSV File Data Decimal and Separator Characters

Select decimal point and separator characters for CSV file data.

**Decimal Mark
(Decimal Point
Character)**

Setting options:(* : default setting)

Dot*	Select the period character.
Comma	Select the comma character.

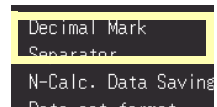

**Separator
(Separator
Character)**

Setting options:(* : default setting)

Comma*	Select the comma character.
Space	Select the space character.
Tab	Select the tab character.
Semicolon	Select the semicolon character.

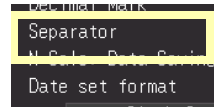

NOTE

The comma character cannot be selected for both decimal point and separator at the same time. By default, comma is the separator character, so it is not available as the decimal character. To select comma as the decimal character, first select a different separator character.

Select the sort order for numerical calculation results

Select whether to save numerical calculation results in a single or multiple CSV files

**N-Calc. Data
Saving
(Sort order for
numerical
calculation
results)**

Setting options:(* : default setting)

Single file*	Saves numerical calculation results in a single file.
Split save	Saves numerical calculation results in multiple files.

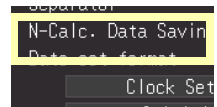

See: "Appendix 3 File Naming" (p. A8)

Setting How to Handle Date Data Stored in CSV Files

This section describes how to configure the handling of date data stored in CSV files.

Date set format

Setting options:(* : default setting)

Comment*	Date data is output using the following format: ' (apostrophe) YEAR (2 digits) - MONTH (2 digits) - DAY (2 digits) HOURS (2 digits) : MINUTES (2 digits) : SECONDS (2 digits) . MILLISECONDS (2 digits). This information is treated as a comment in Excel.
Split msec.	Date data is output using the format, with sub-second time data (unit: ms) is output separately: " (double quotation) YEAR (4 digits) - MONTH (2 digits) - DAY (2 digits) HOURS (2 digits) : MINUTES (2 digits) : SECONDS (2 digits) " (double quotation). In Excel, sub-second time data is displayed in a separate column. This format is convenient when you wish to combine CSV data acquired from different instruments in Excel.

8.4 External Trigger Input Settings

See: "Key Setting Procedure" (p .152)

Selecting the External Trigger Function

Select the function of the EXT.TRIG input terminal.

External Trig In (External Trigger Input)

Setting options:(* : default setting)

Trigger*	Triggering occurs when a signal is applied to the EXT.TRIG terminal.
Event	An event mark is inserted into measurement data when a signal is applied to the EXT.TRIG terminal.

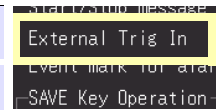

Set Alarm Event Marking

Selects whether an event mark is inserted when an alarm event occurs.

Event mark for alarm (Alarm Event Marking)

Setting options:(* : default setting)

Off*	Event marks are not inserted by alarm events.
On	Event marks are inserted by alarm events.

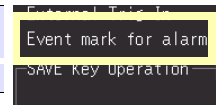

8.5 Making System Settings

Setting the Date and Time

The HiLogger is equipped with an auto-calendar, automatic leap year detection, and a 24-hour clock.

If the clock is not set to the correct time, measurement start time (start trigger time) and file date information will be incorrect. If this occurs, reset the clock.

1 Select the **[System]** Screen.

2 Select **[Clock Setting]**.

Apply
The setting dialog appears.

3 Select an item to change. (year, month, day, hour, minute or second)

Apply

Adjust the setting.

Apply

4 Select **[Set]**.

Apply
The clock is reset.

Change 1's digit

Change 10's digit

Initializing the HiLogger (System Reset)

This procedure resets all settings to their factory defaults.

The system is reset by pressing and holding **STOP** while turning the HiLogger **POWER** switch on.

See: About the factory default settings: "Appendix 6 List of Default Settings" (p. A11)

1 **WAVE/DATA** **SET** **FILE**

Select the **[System]** Screen.

2 Select **[Initialize]**.

Apply
A confirmation dialog appears.

3 Select **[Yes]**.

Apply
Initialization proceeds.

Setting configuration, language selection, and communication-related settings saved in the HiLogger are not reset.

Initializing All Settings (All Reset)
To reset the setting configuration, language selection, and communication-related settings saved in the HiLogger, hold **START** and **STOP** while turning the HiLogger on. When the power is switched on, the language selection screen will display for you to choose the language you wish to use. All Reset sets the communications interface to USB.



Self-Test

The following self tests are available. Results are displayed on the screen. If any faults are found, have the HiLogger repaired. Contact your dealer or Hioki representative.

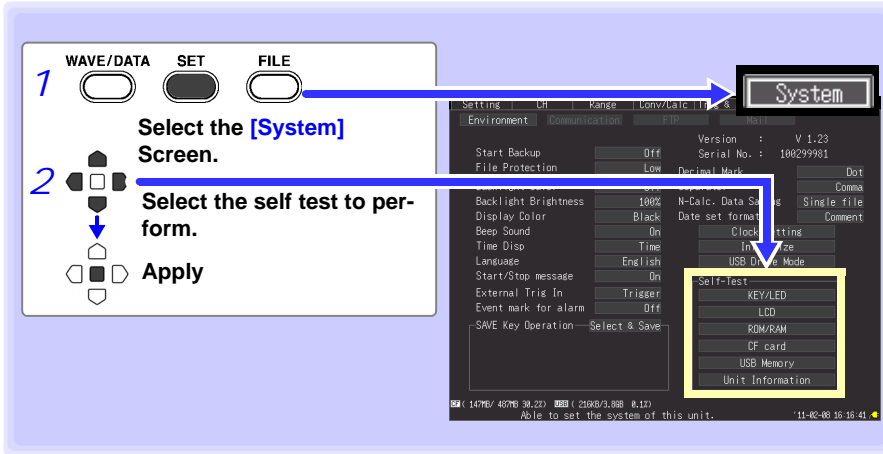

Self-Test	Details
KEY/LED	<p>Tests the keys and LEDs for correct operation. After every key has been pressed, the KEY/LED check finishes. Pressing START also tests whether the LED lights.</p> <p>If you notice a malfunction, press START and STOP simultaneously to abort the test.</p>
LCD	<p>Tests the screen display (character test, gradation test, color test) The screen changes each time you press an operation key.</p> <p>If the display screen seems abnormal, request repairs.</p>
ROM/RAM	<p>ROM/RAM Tests the HiLogger's internal memory (ROM and RAM)</p> <p>If "NG" appears, request repairs.</p>
CF card	<p>Use only Hioki optional CF cards. Non-Hioki CF cards may be unable to provide proper read/write performance, in which case HiLogger performance cannot be guaranteed.</p>
USB Memory	<p>Tests whether the inserted USB flash drive is recognized by the HiLogger.</p>
Unit Information	<p>Displays the input unit configuration.</p>

External Control Chapter 9

The external control terminals on the HiLogger support trigger signal input and output.

Be sure to read p. 41 to p. 43 for external control terminal connection details.

9.1 External Trigger Input

Triggering can be controlled by applying a signal from an external trigger source (p. 106).

This allows synchronous operation of multiple HiLoggers by parallel triggering (p. 164).

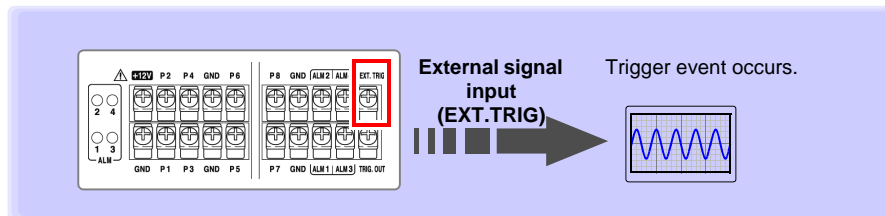

See "Using External Triggering" (p. 106) for setting procedures and trigger signal details.

The external signal input function can be changed to insert event marks.

See: "Inserting Event Marks Using External Input Signals" (p. 94)

9.2 External Signal Output (Trigger Output)

You can output a signal when a trigger event occurs. This allows synchronous operation of multiple HiLoggers by parallel triggering (p. 164).

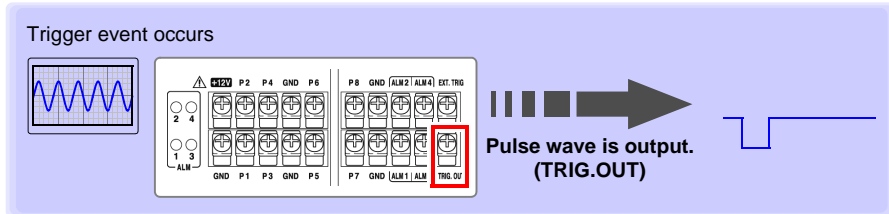

Trigger Output Signals

Output signal Open collector output (with voltage output), active LOW

Output voltage range HIGH level: 4.0 to 5.0 V, LOW level: 0 to 0.5 V

Pulse width LOW level: 10 ms or greater

Maximum input voltage -20 to +30 V, 5 mA max, 200 mW max

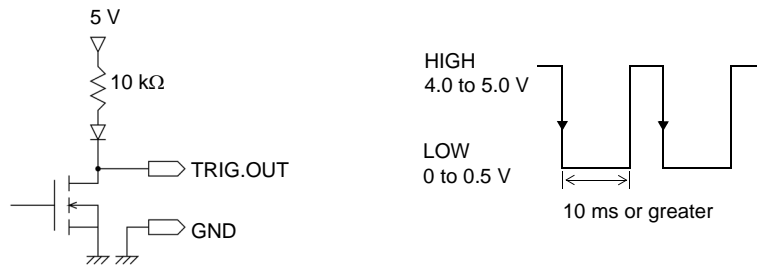

NOTE The signal is output even when triggering is not enabled. When triggering is not otherwise used, a trigger signal is output during measurement.

Signal Output Procedure

Connect the HiLogger's TRIG.OUT external control terminal to the external device to be triggered.
(See the connection procedure on p. 43)

When a trigger event occurs, a pulse wave changing from the HIGH level (4.0 to 5.0 V) to the LOW level (0 to 0.5 V) is output from the TRIG.OUT terminal.

9.3 Alarm Signal Output (Alarm Output)

This signal is output when alarm criteria are satisfied.

Specify the desired alarm criteria.

See: "5.2 Alarm Output" (p. 109)

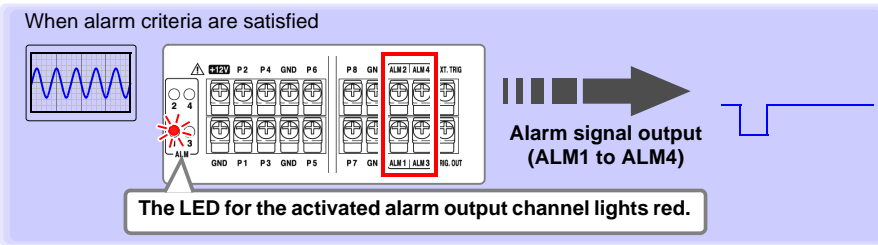

About the Alarm Output Signal

Output signal	Open collector output (with voltage output), active LOW
Output voltage range	HIGH level: 4.0 to 5.0 V, LOW level: 0 to 0.5 V
Output Refresh	Every recording interval
Maximum switch rating	5 to 30 VDC, 200 mA

Below is a diagram showing the structure map of the HiLogger's alarm output circuit, and an example of a connection with the relay.

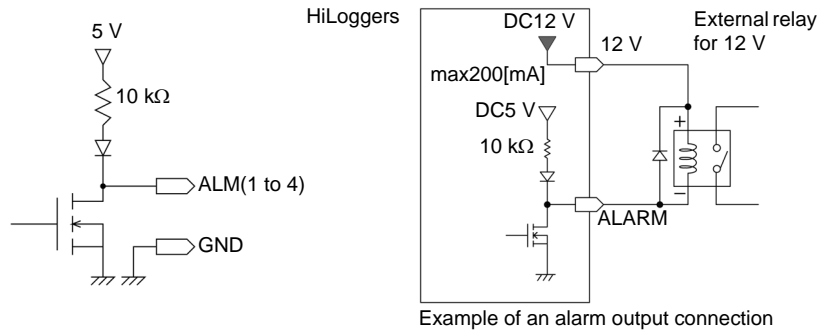

Signal Output Procedure

Connect the HiLogger's ALM external control terminals to the external devices.
 (See the connection procedure on p. 41)

When the alarm criteria are satisfied, a Low level (0 to 0.5 V) signal is output.

9.4 Synchronous Measurements with Multiple HiLoggers

NOTE

Although this function synchronizes the measurement start time of multiple HiLoggers to the external trigger signal, it does not synchronize actual sampling times.

Over long-term measurements, data acquisition times will differ because of sampling block scattering on each HiLogger.

Multiple HiLoggers can be synchronized using the external control terminals. Two synchronization methods are available, as follows.

Daisy chain (serial) synchronization

Set all HiLogger to master.

Setting Procedure

On all HiLoggers, set the **[External Trig In]** to **[Trigger]** (p. 106).

Triggering any HiLogger triggers all connected HiLoggers. As the number of connected HiLoggers is increased, the trigger time difference between them becomes larger.

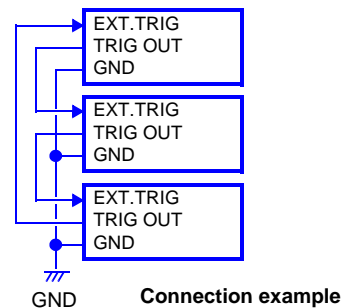

Parallel synchronization

Set one HiLogger to master, and set the others to slave.

Setting Procedure

On the slave HiLoggers, set the **[External Trig In]** to **[Trigger]** (p. 106)

One HiLogger serves as the master (for trigger control), so that when it is triggered, all other HiLoggers start measuring at the same time.

Use this method to minimize the trigger time difference between HiLoggers.

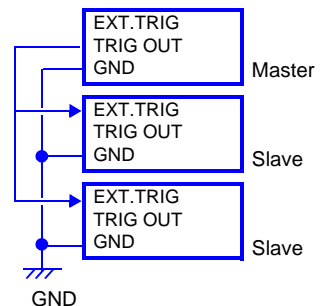

Connection to a PC (Communication) Chapter 10

Communication is available by connecting a PC to the HiLogger with an Ethernet or USB cable.

Communication Features

Item	LAN (100BASE-T)	USB	Ref.
Real-time measurements using the Logger Utility program (on the supplied CD)	O	O	10.3 (p. 187)
Remote operation by HTTP server	O*2	X	10.4 (p. 188)
Manual data acquisition by FTP server	O	X	10.5 (p. 193)
Auto send data to FTP client	O*1	X	10.6 (p. 196)
Automatic e-mail sending (notification)	O*1	X	10.7 (p. 216)
Measuring with a program created with Visual Basic	O*3	O	10.8 (p. 223)

*1 : Not available while measuring with the Logger Utility.

*2 : Not available while measuring with the Logger Utility or a program created with Visual Basic or other languages.

*3 : Data cannot be transferred in real time with recording intervals shorter than one second. Use the Logger Utility for shorter recording intervals. However, data recorded at shorter intervals can still be obtained after measurement has finished. To create a program, see the Communications Command Instruction Manual on the supplied application CD.

10.1 USB Settings and Connections

Connect the USB cable to a PC to transfer data from the CF card (p. 140), and to communicate using the Logger Utility (p. 187), or communications commands (p. 223).

1. HiLogger Setting

Select the HiLogger's USB interface.

The screenshot shows the HiLogger's settings menu. At the top, there are three buttons: WAVE/DATA, SET, and FILE. The 'System' option is highlighted with a blue box and labeled '1'. Below it, the 'Communication' option is highlighted with a blue box and labeled '2'. Under 'Communication', the 'Communication Interface' option is highlighted with a blue box and labeled '3'. The 'Communication Interface' option is currently set to 'USB'. Below the 'Communication Interface' option, there are two options: 'Delimiter: CR+LF' and 'Header: 0xFF'. At the bottom of the screen, there is a status bar with the text: 'Switch the communication interface. Select LAN or USB. 12:45:57.56:00:00'.

1 Select the **[System]** Screen.

2 Select **[Communication]**.
The Communications Settings appear.

3 Select **[Communication Interface]**.
Open

Select **[USB]**.

Apply

2. Installing the USB Driver

Install the USB driver as described below before connecting to the Memory HiLogger via USB cable.

NOTE If you install the USB driver in Windows2000, the USB Drive Mode of the device will be disabled.

1 Install the driver.

Run **[SetupDriver32.msi]** in the CD-R.

If [Logger Utility] is already installed, run the CD from the following location.

[c:\Program Files\HIOKI\LoggerUtility\Driver\SetupDriver32.msi]

If you are using the WindowsVista/7 64bit version:

Run **[SetupDriver64.msi]** in the CD-R.

If Logger Utility is already installed, run the CD from the following location.

[c:\Program Files\HIOKI\LoggerUtility\Driver\SetupDriver64.msi]

NOTE Depending on the environment, the dialog box may take some time to appear so please wait till it does so.

2 Click **[Next]**.

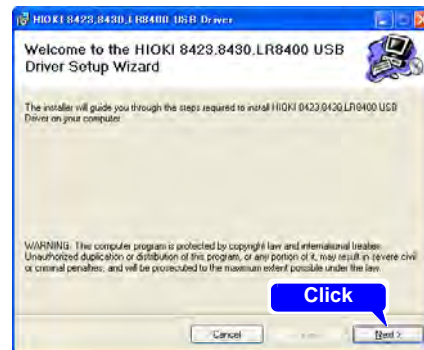

3 Check **[Everyone]** and Click **[Next]** to start installing.

When you want to change the installation destination

Click **[Browse...]** to change the folder to install into. Normally, there is no need to change.

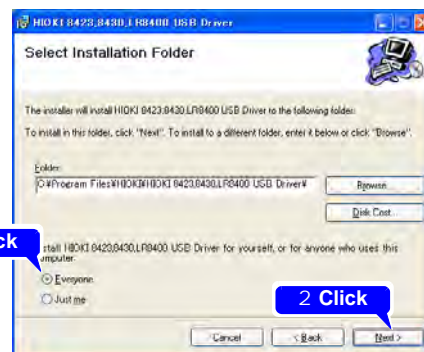

10.1 USB Settings and Connections

4 Click [Next] to start installing.

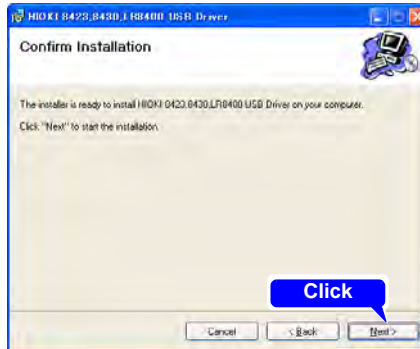

Installing

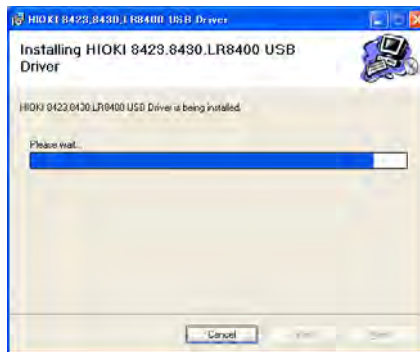

For WindowsXP

During the installation, a message saying that the software has not passed Windows Logo testing will appear a few times, click [Continue Anyway] to continue installing.



For WindowsVista/7

When a dialog box requesting your permission to continue the program appears, click [Continue].

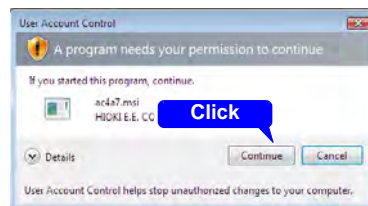

10.1 USB Settings and Connections

Sometimes another dialog box requesting your permission to install the software may appear. When it does, check **[Always trust software from "HIOKI E.E. CORPORATION"]** and click **[Install]** to continue.

- 5 When installation is completed and the dialog box appears, click **[Close]** to exit.

This completes the driver installation.

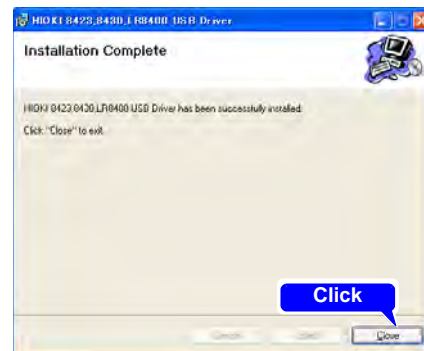
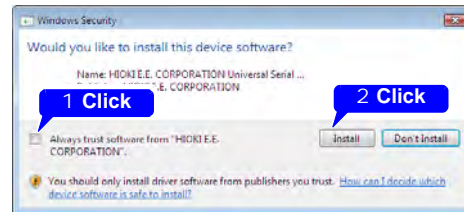

3. Connecting the HiLogger to a PC

Connect the HiLogger to the PC with a USB cable.

Install the USB driver before communicating with the HiLogger the first time (p. 167).



WARNING

To avoid electric shock hazards, turn off all devices before connecting or disconnecting the USB cable.



CAUTION

- Do not pull out the USB cable during data transfer. Doing so would prevent proper data transfer.
- The HiLogger and PC should be connected to the same earth ground. If grounded separately, potential difference between the ground points can cause malfunctions or damage when connecting the USB cable.

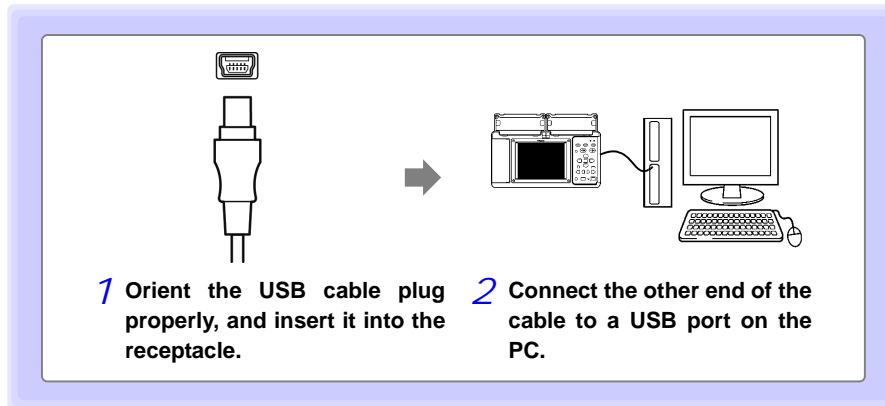

The first time the computer is connected to the HiLogger, follow the next steps to recognize the HiLogger.

For Windows2000/Vista/7

The HiLogger is automatically recognized, and preparations to use the device are complete.

For WindowsXP

- 1 A [Found New Hardware Wizard] dialog box will appear and the new hardware detection wizard will begin.

Check [No, not this time] and click [Next].

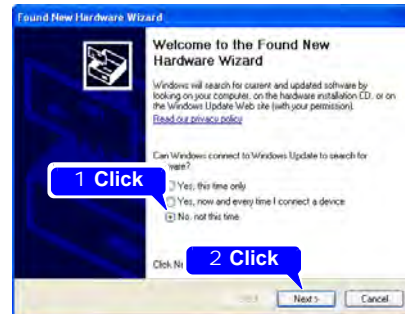

- 2 Check [Install the software automatically (Recommended)] and click [Next].

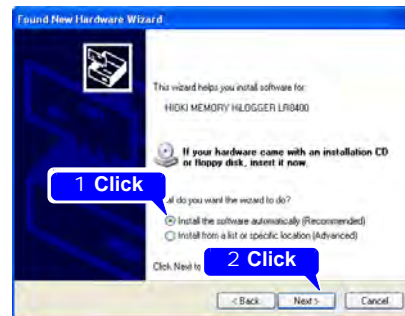

Please wait while the driver is being installed.



- 3 Click [Continue Anyway].

A message saying that the software has not passed Windows Logo testing will appear a few times, click [Continue Anyway] to continue installing.

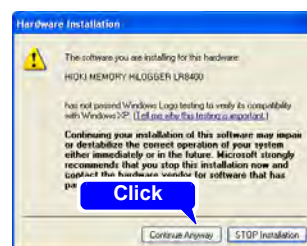

10.1 USB Settings and Connections

- 4 When installation is completed and the dialog box appears, click **[Close]** to exit.

This completes the driver installation.



Features Available After USB Setting and Connection

Transferring Data from a CF Card to a PC (p. 140)

Data saved to a CF card can be transferred to a PC.

Controlling by Logger Utility(p. 187)

The supplied Logger Utility program provides PC control over HiLogger settings and measurement data recording and observing.

Controlling by Communications Commands (p. 223)

See the Communications Command Instruction Manual on the supplied application CD.

4. Installing the Logger Utility Program

The Logger Utility program can be installed from the supplied CD, or you can download the latest version from the Hioki web site.

Operating Environment Confirmation and Preparation

Verify operating environment compatibility before installing.

Operating Environment

OS	Windows 2000 (with SP4 or later) Windows XP (with SP2 or later) Windows Vista Windows 7
CPU	Pentium III (500 MHz) or better
Monitor Resolution	1024 x 768 dots or better
Internet Explorer	6.0 or better
Memory	At least 512 MB
Interface	An available Ethernet or USB receptacle

Preparation

Insert the supplied CD in the PC's CD-ROM drive, or unzip the downloaded application program file on the PC.

Installation Procedure

Install the Logger Utility with this procedure. This explanation is for installing the software on Windows XP. The messages displayed may differ slightly depending on other operation system or settings you are using.

Important

If you are running software such as antivirus software, be sure to end the software before you start the installation. The installation may not be performed properly if antivirus software is running.

1 Start up Windows.

Exit all running applications.

2 Insert the included CD into the PC's CD-ROM drive.

The installer run automatically.

If the installer do not start, execute **[setup.exe]** from the CD-ROM drive.

In Vista, Although the dialog which ask for installation permission of application, click **[Allow]**.

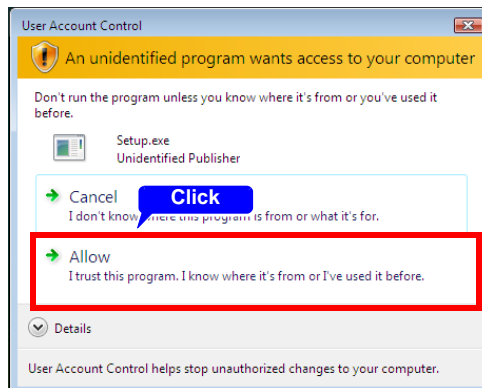

3 In the installer, click **[Next]** and confirm the installation destination.

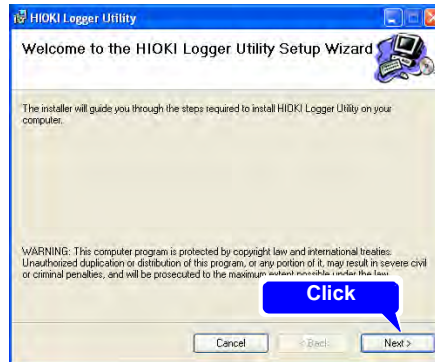

The end user license agreement is displayed. Read the EULA, then select **[Agree]**, and click **[Next]**.

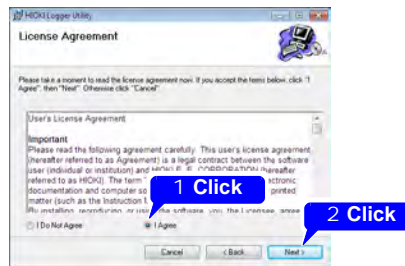

The installation destination folder can be changed on this screen.

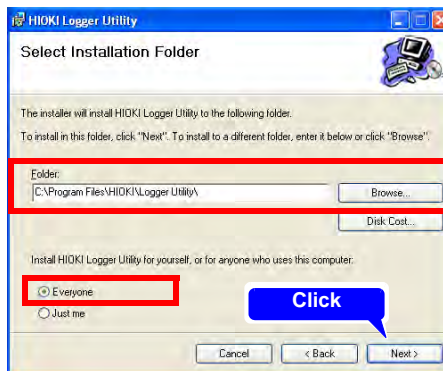

If you are not changing the installation destination, click **[Next]**.

To change the installation destination, click **[Browse]** to select another folder.

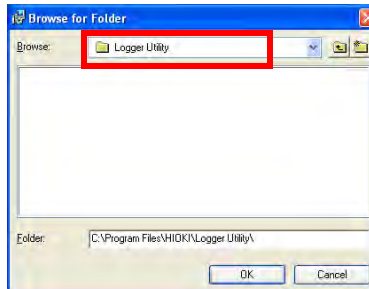

176

10.1 USB Settings and Connections

4 Click **[Next]** to start installing.

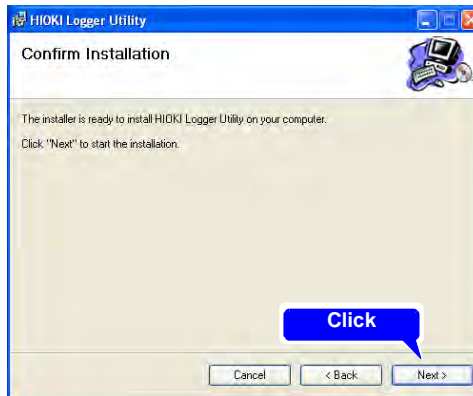

Installation starts.

Progress is displayed during installation. To interrupt installation in progress, click **[Cancel]**.

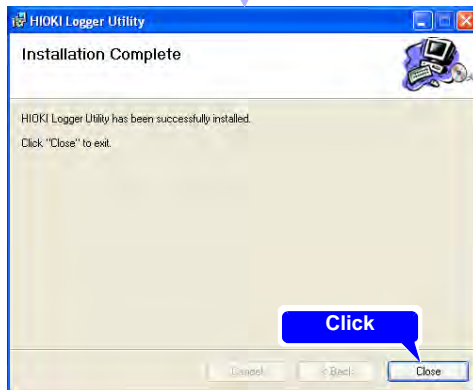
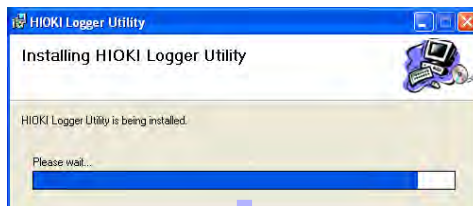

Installation finished

Note: After the Logger Utility has been installed, the CD can be removed from the drive.

Uninstalling the Logger Utility

When the Logger Utility is no longer needed, uninstall it with the following procedure.

- 1 From the Windows Start menu, select the **[Control Panel]**, and double click **[Add or Remove Programs]**.



- 2 From the list of installed programs, select **[Logger Utility]**, and remove it. You are returned to the **[Add or Remove Programs]** screen. Settings files are not deleted during uninstall, so if no longer needed, delete them manually.

10.2 LAN Settings and Connections (Before connecting to the network)

The required settings are different, depending on whether the HiLogger is to be connected to an existing network or directly to a PC.

NOTE

Always make LAN settings before connecting to the network. If you change settings while connected to the network, IP addresses may overlap or invalid address data may flow over the network.

Things to Check Before Making Settings

The required settings are different, depending on whether the HiLogger is to be connected to an existing network or whether a new network consisting only of the HiLogger and one PC is to be configured.

When Connecting the HiLogger to an Existing Network

The following items must be assigned in advance by your network administrator. Be sure that there is no conflict with other devices.

Whether to use DHCP	Yes/No
The host name and address of the HiLogger	Subnet mask: _____._____._____._____ (When DHCP is used, the IP address and subnet mask are not required)
Gateway	Whether to use a gateway: Yes/No IP Address (when used): _____._____._____._____ (When DHCP is used, the gateway address is obtained from the DHCP server, so it does not need to be specified here)
The TCP/IP port number to use	____X (default 880X) (Specify at least the three most significant digits of the four- or five-digit port number. The least significant digit (0 to 9) is reserved for use by the HiLogger. Specify when the default 8800 to 8809 cannot be used.)

When Configuring a New Network with a PC and This HiLogger

(Using as Local Network Without External Connections)

If there is not administrator for your network, or if you have been entrusted with settings, the following addresses are recommended.

(Settings example)

```
IP Address
PC          : 192.168.1.1
First recorder : 192.168.1.2
Second recorder : 192.168.1.3 and so on, in sequence.
              ↓
Host name   : Any name (However, must be unique)
Subnet mask : 255.255.255.0
Gateway    : Off
DHCP       : Off
Port number : 880X
```

10.2 LAN Settings and Connections (Before connecting to the network)

Setting Items

Use DHCP*	DHCP is a protocol that allows devices to automatically obtain and set their own IP addresses.
*: Dynamic Host Configuration Protocol	If you enable DHCP and there is a DHCP server operating in the same network, the HiLogger's IP address, subnet mask, and gateway can be obtained and set automatically.
Host Name	This is a name that identifies the HiLogger on the network. Assign a host name that is different from the names of all other devices. This HiLogger does not support dynamic DNS, the name that you set is not registered with a DNS server.
IP Address	This is an address that identifies an individual device on a network. Assign an address that is different from the addresses of all other devices. If DHCP is enabled, the address is assigned automatically by the DHCP server.
Subnet Mask	This is a setting used to divide an IP address shown to the network into a network address and a host address. Use the same subnet mask for all devices in the same network. If DHCP is enabled, the subnet mask is assigned automatically by the DHCP server.
Use Gateway IP Address	For network connections: When your PC (or the communicating device) is on another network than this HiLogger, set this to [On] and specify the gateway device. When the PC is on the same network, this is usually set to the same address as the default gateway in the PC communications settings.

Authorization User Name and Password

These are used when you login to the HiLogger by FTP, or use a PC browser (with the authorization setting set to on).

When authorization is enabled, login is not possible unless a correct user name and password are entered. This setting is recommended if you wish to restrict the users who can access the HiLogger.

The "Password" item is displayed as "*****".

Valid characters: Alphabetic characters and symbols

If you want to allow anyone to access, or you wish to login as "anonymous" with a FTP client, leave the user name and password fields blank.

1. PC Network Setup

The setup procedure is the same when connecting one HiLogger to the PC as it is when connecting multiple HiLoggers to the PC through a hub.

These instructions presume a network configured as follows.

IP Address	192.168.1.0/24 (network address) (or, enter 192.168.1.1 as a private IP address*)
Subnet Mask	255.255.255.0

*: Although the IP address can be freely set, a private IP address is normally more secure.

To display the following dialogs

1. Click the Windows [Start] button and select [Control Panels]-[Network and Internet Connections]-[Network Connections]-[Local Area Connection].
2. Right click [Local Area Connection], and select Properties.

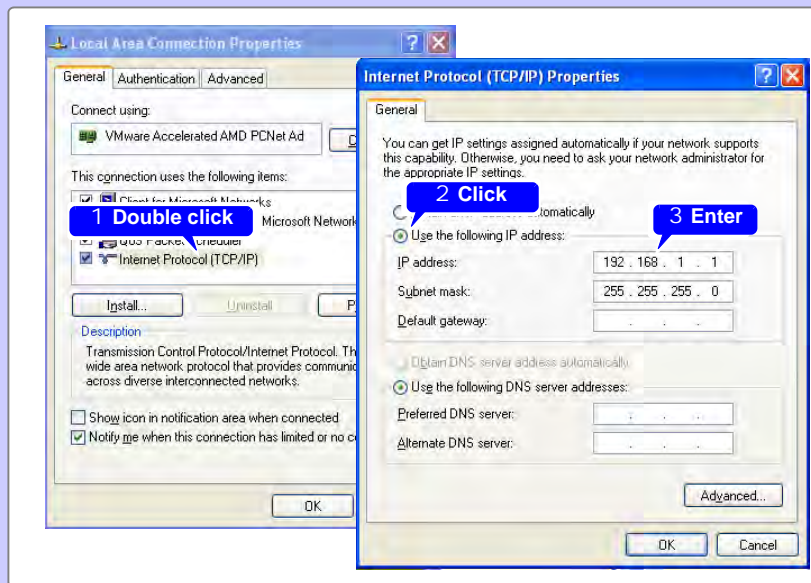

2. HiLogger Settings

1 Select the [System] Screen.

2 Select [Communication].
The communications settings appear.

3 Select [Communication Interface].
Open

Select [LAN].

Apply

4 Move to a setting item.

Open

Set

Apply

5 Move to [Apply] item.

Apply

2 Communication

3 Communication Interface LAN Apply **5**

4

Host Name		Delimiter	CR+LF
DHCP	Off	Header	Off
IP Address	192 . 168 . 1 . 2		
Subnet Mask	255 . 255 . 255 . 0		
Port	880X		
Gateway	Off		
DNS	Off		
DNS IP			

MAC Address: 98 - 01 - 67 - 98 - 76 - 54

See: "Setting Items"(p. 182)
"Setting Example"(p. 183)

Host Name	
DHCP	Off
IP Address	192 . 168 . 1 . 2
Subnet Mask	255 . 255 . 255 . 0
Port	880X
Gateway	Off
Gateway IP	0 . 0 . 0 . 0
DNS	Off
DNS IP	0 . 0 . 0 . 0

Numerical Settings

Increment/decrement by 1

Increment/decrement by 10

Character Settings

See: "3.7 Entering Titles and Comments (as needed)" (p. 71)

10.2 LAN Settings and Connections (Before connecting to the network)**Setting Items****Host Name** Specify the host name for the HiLogger.

Setting options

Up to 12 characters (e.g., LOGGER)

DHCP Enable or disable DHCP function.

When enabled, the IP address and subnet mask are obtained automatically.

Setting options: (* : default setting)

Off* Disable DHCP.**On** Enable DHCP.**IP Address** Set the HiLogger's IP address.

Setting options

.._._ (where _ is 0 to 255, e.g., 192.168.1.2)

Subnet Mask Set the subnet mask.

Setting options

.._._ (where _ is 0 to 255, e.g., 255.255.255.0)

Port (Port Number) Set the TCP/IP port number to be used by the HiLogger.

The lowest digit is reserved for use by the HiLogger.

Setting options

____ (where _ is 0 to 9, e.g., 880X)

Gateway IP Set this only when **[Gateway]** is enabled.

Set the IP address of the gateway device.

Setting options

.._._ (where _ is 0 to 255)

DNS Select whether to use DNS.

Setting options: (* : default setting)

OFF* Do not use DNS.**ON** Use DNS.**DNS IP** Set this only when **[DNS]** is enabled.

Set the DNS server's IP address.

Setting options

.._._ (where _ is 0 to 255)

Setting Example**Connecting one HiLogger to one PC**

Host Name	LOGGER
DHCP	Off
IP Address	192.168.1.2
Subnet Mask	255.255.255.0
Port	880X
Gateway	Off
DNS	Off

When connecting multiple HiLoggers to a PC through a hub

This example is a local area network with no external connection. We recommend using only private IP addresses. As below, make sure that no host names or IP addresses are duplicated.

First HiLogger

Host Name	LOGGER1
IP Address	192.168.1.2

Second HiLogger

Host Name	LOGGER2
IP Address	192.168.1.3

Third HiLogger

Host Name	LOGGER3
IP Address	192.168.1.4

Common Settings

DHCP	Off
Subnet Mask	255.255.255.0
Gateway	Off
Port	880X

NOTE

LAN communications with a PC require that the HiLogger is first set correctly.

3. Connecting the HiLogger to a PC

Connect the HiLogger to the PC with an Ethernet cable.



Always turn both devices OFF when connecting and disconnecting a LAN cable. Otherwise, an electric shock accident may occur.

HiLogger Ethernet Jack

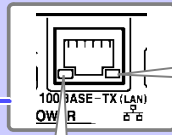
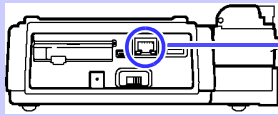

Yellow LED
Lights when communicating at 100 Mbps, and not lit at 10 Mbps.

Green LED
Lights when linked, and blinks during communication.

NOTE

If the green LED does not light when connected to the LAN, the HiLogger or connected device may be damaged, or the cable may be faulty.

Connecting one HiLogger to one PC

Items to prepare: 9642 LAN Cable, Cross-over adapter (supplied)

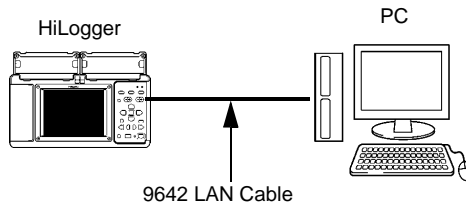
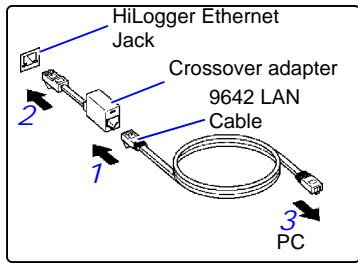

Connecting through a Hub

Items to prepare: 9642 LAN Cable (2), Hub

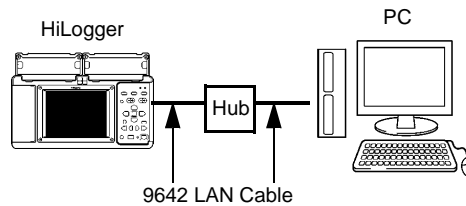
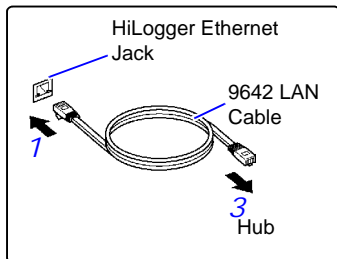

Features Available After LAN Setting and Connection**Using the Logger Utility (p. 187)**

The supplied Logger Utility program provides PC control over HiLogger settings and measurement data recording, and data observation.

Remote Operation (p. 188)

A standard web browser such as Internet Explorer (IE) can be used to make HiLogger settings and to control remote data acquisition and on-screen monitoring (HTTP server functions).

Downloading Data to a PC (p. 193)

The HiLogger's internal memory data and files on its removable storage can be transferred to a PC running an FTP client.

Automatically Sending Data to a PC (p. 196)

Binary files auto saved by the HiLogger to removable storage can be automatically sent to other network clients, or to a remote FTP server. Use the FTP client function.

Sending E-Mail (p. 216)

E-Mail notifications can be automatically sent from the HiLogger when start or stop triggering occurs, and when an alarm, power outage recovery, memory-full or removable-storage-full event occurs. It can be sent to a network device, remote PC, or mail-capable cell phone via an SMTP mail server.

Controlling by Communications Commands (p. 223)

See the Communications Command Instruction Manual on the supplied application CD.

When LAN Communication Fails**■ Confirm cable connections.**

When connecting one HiLogger to one PC, use the supplied cross-over adapter with the 9642 LAN Cable.

In case of poor connection, disconnect and reconnect the cable to clean the contacts. When connecting the cable, the green LED on the HiLogger's LAN jack should light.

■ Confirm the PC's IP address.

Click **[Run...]** on the Windows Start menu (or select **[All Programs]-[Accessories]-[Command Prompt]**) and enter "**ipconfig /all**" to confirm the IP address of the network interface, subnet mask, and gateway address.

If settings are incorrect:

Refer to "1. PC Network Setup"(p. 180) to reset the IP address.

■ Confirm communication between the HiLogger and PC.

After confirming that the IP addresses of the HiLogger and PC are correct, use the "**ping**" utility to test data transfer.

1.From the Start menu, select **[All Programs]-[Accessories]-[Command Prompt]**.

2.(at the blinking cursor)

Enter "**ping XXX.XXX.X.X**"(the IP address of the host device to test).

Alternatively, the host name can be entered if its IP address is assigned by DNS.

For example, if the HiLogger's IP address is 192.168.1.2, enter "**ping 192.168.1.2**" and press Enter.

The following display text indicates normal operation. The "time" is the communication response time.

Pinging 192.168.1.2 with 32 bytes of data:

Reply from 192.168.1.2: bytes=32 time<10ms TTL=32

Reply from 192.168.1.2: bytes=32 time<10ms TTL=32

Reply from 192.168.1.2: bytes=32 time<10ms TTL=32

Reply from 192.168.1.2: bytes=32 time=1ms TTL=32

The following display text indicates communications failure.

Recheck cable connections.

Pinging 192.168.1.2 with 32 bytes of data:

Reply from 192.168.1.2: Host is down.

Reply from 192.168.1.2: Host is down.

Reply from 192.168.1.2: Host is down.

Reply from 192.168.1.2: Host is down.

10.3 Using the Logger Utility

The supplied Logger Utility program provides PC control over HiLogger settings and measurement data recording, and data observation.

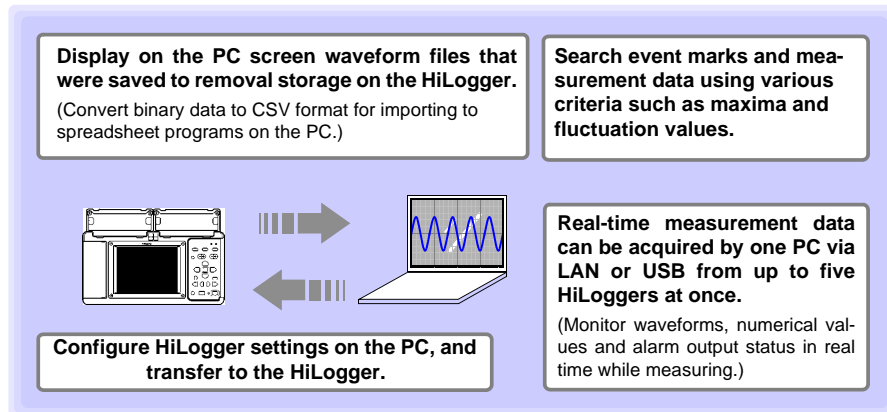

For details such as Logger Utility operating instructions, read the instruction manual (PDF file) provided on the CD.

Starting and Ending Logger Utility

Starting Logger Utility

From the Start Menu of Windows, click **[All Programs]-[HIOKI]-[Logger Utility]-[Logger Utility]**.

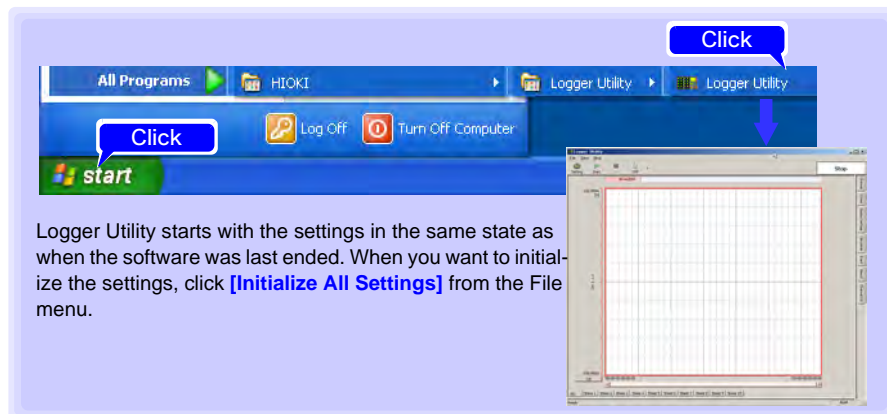

Logger Utility starts with the settings in the same state as when the software was last ended. When you want to initialize the settings, click **[Initialize All Settings]** from the File menu.

Ending Logger Utility

Click **[Exit Application]** from the File menu of the main screen. Alternatively, you can click the **[x]** close button at the top right of the main screen.

10.4 Remote Measurement with the HTTP Server Function

The HiLogger includes an HTTP server function for remote data acquisition and on-screen monitoring using a web browser such as Internet Explorer (IE).

NOTE

- LAN settings and connections must be made before using the HTTP server function for remote measurements (p. 178).
- The HTTP server function is not available while measuring using the Logger Utility program.

Displaying the Main Page

- 1 Start IE.
- 2 Enter the HiLogger's address (e.g., <http://192.168.1.2>) in the [Address] field.

The main page appears.

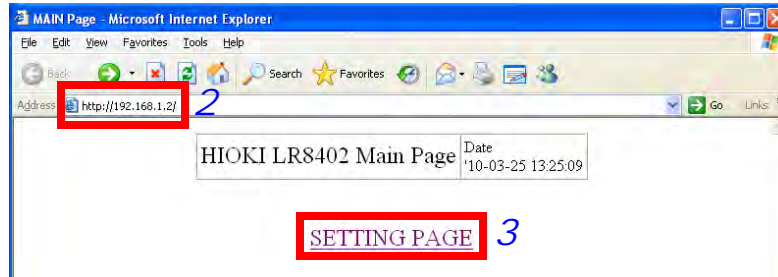

- 3 Select [SETTING PAGE].
- 4 (When the [FTP/HTTP Authentication] HiLogger setting is enabled) Enter the user name and password, and press the [SET].

To avoid unauthorized access to HTTP functions, we recommend securing connections with a user name and password on the Communications Settings display of the HiLogger's [System] screen. FTP/HTTP authentication can be disabled when frequent access to the HiLogger from multiple PCs is necessary.

See: "Enable [FTP/HTTP Authentication]." (p. 212)

NOTE

- Microsoft Internet Explorer Version 5 or later is recommended as the browser. Set the security level to "Medium" or "Medium-high", and invalidate the pop-up block.
- Remote operation by HTTP is not available while measuring with the Logger Utility or a Visual Basic program.

If no HTTP screen is displayed

1. Perform this procedure.
 - (1) Click **[Tools]-[Internet Options]** to display IE settings.
 - (2) On the **[Advanced]** tab, under HTTP 1.1 settings, enable **[Use HTTP1.1]** and disable **[Use HTTP1.1 through proxy connections]**.
 - (3) On the **[Connections]** tab, click **[LAN Settings]**, and disable **[Use a proxy server]**.
2. LAN communications may not be possible. See "When LAN Communication Fails"(p. 186).

What if the Remote Operating Screen does not appear?

Java may not be installed. To operate the HiLogger from a web browser, depending on the PC's software environment, Java may need to be installed separately. In that case, download and install JRE (Java Runtime Environment) from the Java web page.

Attempting to operate the HiLogger by multiple PCs at the same time may result in unintended actions. Remote control operation should be performed from only one PC at a time. If the security setting blocks the Remote Operating Screen from being displayed, add the address of Model LR8400 (for example, <http://192.168.1.2/DISP.HTM>) to the exception site list.

For more information, visit "Manage the Exception Site List" of the Java website at http://docs.oracle.com/javase/7/docs/technotes/guides/jweb/security/exception_site_list.html.
http://docs.oracle.com/javase/7/docs/technotes/guides/jweb/security/exception_site_list.html

Remote Operating

Click **[REMOTE CONTROL]** to view the current HiLogger screen in the web browser.

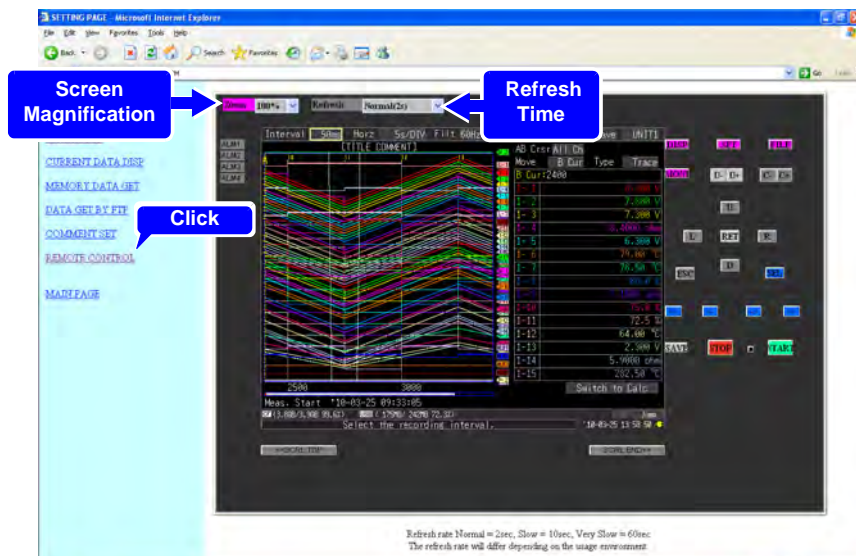

- The displayed panel emulates the HiLogger's. Click the keys with the mouse to operate.
- Screen refresh time can be selected from Off, or 2, 10, or 60 seconds. Refreshing the screen also refreshes the on/off state of the Start LED.
- The emulated screen can be enlarged or reduced.

Start/Stop Measurement

Click [START/STOP] to display this screen.

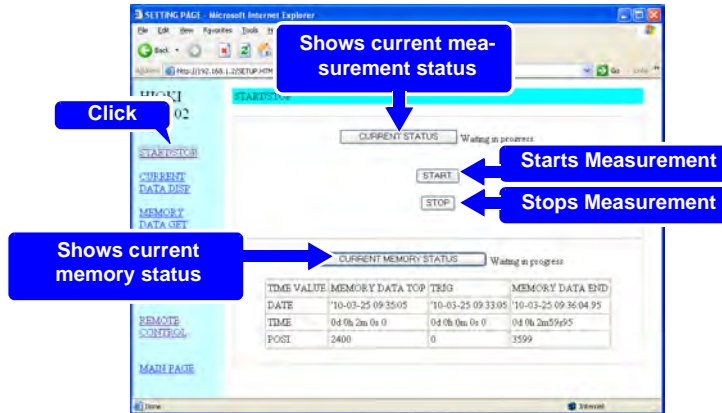

Click the buttons to operate.

Viewing Current Measurement Values

Click [CURRENT DATA DISP] to display current measurements.

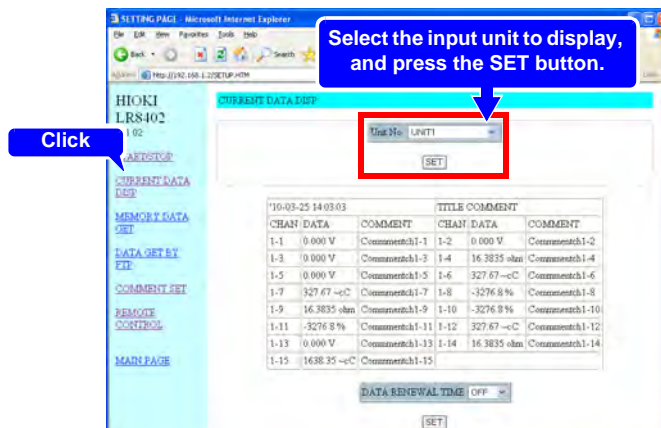

- While measuring, you can monitor numerical data acquired from each channel at every recording interval. Screen refresh time can be selected from Off, or 5, 10, or 60 seconds.
- When measurement is stopped, instantaneous input data from each channel is displayed.
- You can select which input unit to display.

Acquiring Data from Internal Memory

Click **[MEMORY DATA GET]** to display this screen.

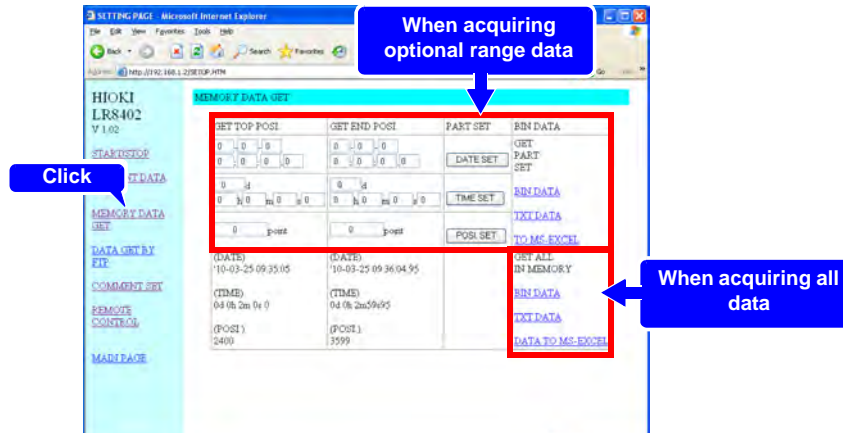

NOTE Data acquired into the HiLogger's internal memory cannot be accessed while measuring. It is possible only after measurement stops.

When acquiring optional range data

- 1 Specify the time span of data to acquire, and click the SET button.
- 2 Under **[GET PART SET]**, click **[BIN DATA]**, **[TXT DATA]**, or **[TO MS-EXCEL]**.

When acquiring all data

Under **[GET ALL IN MEMORY]**, click **[BIN DATA]**, **[TXT DATA]**, or **[DATA TO MS-EXCEL]**.

Setting options:

BIN DATA	Acquires data in binary format.
TXT DATA	Acquires data in text format.
TO MS-EXCEL, DATA TO MS-EXCEL	Send data to Excel. Useful for creating graphics.

Setting Comments

Click **[COMMENT SET]** to display this screen.

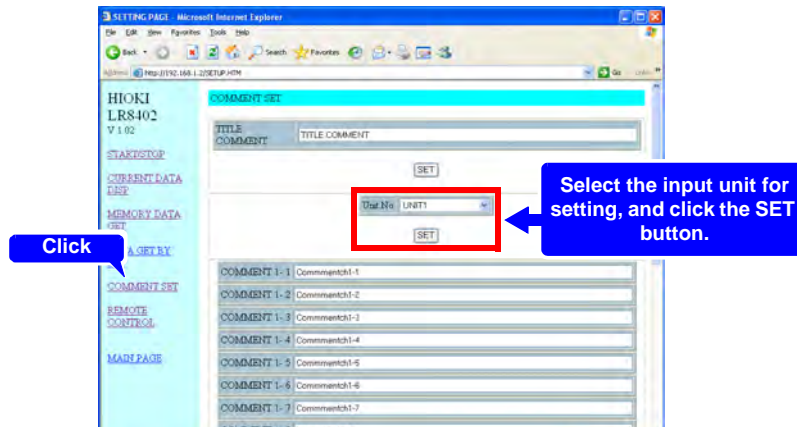

- Comments for each channel can be simply entered from the web browser. Enter a comment, and click the **[SET]** button.
- You can select another input unit for setting.

NOTE

- Comments cannot be changed while measuring.
- Please input 8-bit ASCII characters, the HiLogger can not display other characters.

10.5 Transferring Data to a PC with the FTP Server Function

FTP (File Transfer Protocol) is used for file transfers within a network. The HiLogger's FTP server function works with an FTP client running on a PC to transfer HiLogger data files from internal memory and removable storage to the PC.

- 1 Start IE to display the Settings screen (p. 188).
- 2 Click **[DATA GET BY FTP]**.

This screen is displayed.

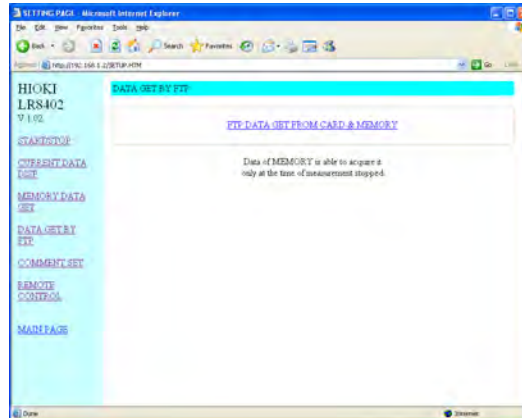

- 3 Click **[FTP DATA GET FROM CARD & MEMORY]**.

The HiLogger's CF card, USB flash drive, and internal memory file folders are listed.

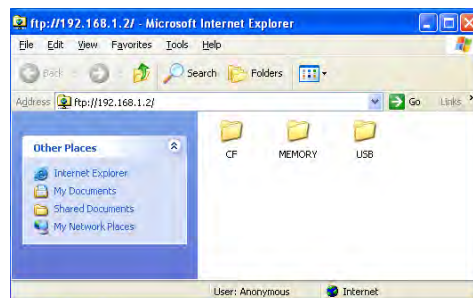

[CF] indicates the CF card, **[USB]** the flash drive, and **[MEMORY]** indicates internal HiLogger memory.

10.5 Transferring Data to a PC with the FTP Server Function

NOTE

- Entering just the HiLogger's IP address (e.g., <ftp://192.168.1.2>) in a browser such as IE displays the CF card, USB flash drive, and internal memory file folders.
- Internal memory data cannot be transferred while measuring. It is accessible when measurement stops. Files containing either current or previously saved data (real-time, CSV, and calculation results) are inaccessible while measuring.
- When [\[FTP/HTTP Authentication\]](#) is enabled, enter the required user name and password, and press the [\[SET\]](#) button.

See: We recommend restricting file access with a user name and password to avoid unauthorized access. "Enable [FTP/HTTP Authentication]." (p. 212)

4 Open a folder.

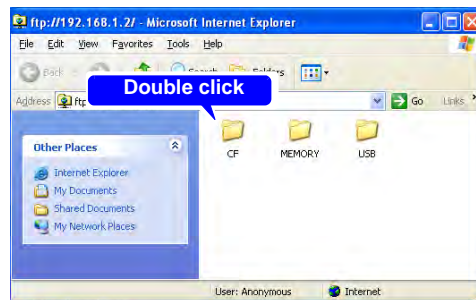

5 Select a file, and [\[Copy To Folder\]](#).

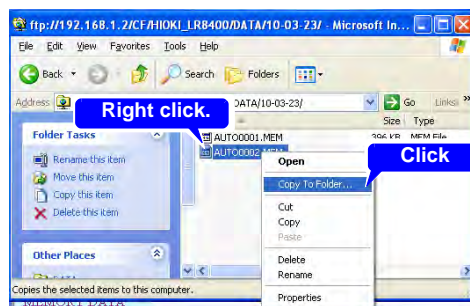

10.5 Transferring Data to a PC with the FTP Server Function

NOTE

- The FTP server of the HiLogger allows only one connection at a time. More than one PC cannot access the server simultaneously.
- If no command is sent from a PC for more than one minute after connecting to the FTP server, the FTP may disconnect the PC. Reconnect the FTP.
- The FTP connection may fail after disconnecting and attempting to reconnect. In this case, disconnect again and wait for one minute before reconnecting.
- During real-time, auto, or manual saving, and when deleting files, creating or deleting folders, or renaming, formatting, or loading files on the HiLogger, only file transfers are possible from the FTP client.
- If an FTP transfer is writing to removable storage when auto saving starts or numerical calculations are saved, FTP operation is suspended during data saving.
- When measurement ends during an FTP transfer, the transfer may be suspended during data saving.
- Before inserting or removing a removal storage, terminate the FTP connection.
- Although the HiLogger's removable storage can be externally accessed using FTP, avoid other HiLogger operations such as using telnet at the same time. Otherwise, unintended operations could occur.
- With IE, the refresh date of files may not match those of the main HiLogger.
- With IE, previously obtained data can be retained in temporary internet files, and may be reloaded in place of the latest data. If the HiLogger's data has been refreshed, restart IE before using FTP. (A free alternative to IE is FFFTP.)

Restricting FTP Server Connections (FTP Authentication)

[FTP/HTTP Authentication] Setting (p. 212).

Anonymous authentication allows unrestricted access to the HiLogger's FTP server by all network devices.

To restrict access to the FTP server, enable FTP/HTTP authentication and set a user name and password.

We recommend restricting file access with a user name and password to avoid unauthorized use.

10.6 Auto Sending Data using the FTP Client Function

Files auto saved by the HiLogger to removable storage can be automatically sent to other network clients, or to a remote FTP server.

NOTE

- Set Auto Save to Waveform (realtime), CSV (realtime), Waveform+Calc, or CSV+Calc.
 - Calculated values are not transferred automatically.
 - To save or transfer data periodically, set the Split Save setting to Periodic.
 - To continue saving or transferring data even when the CF card becomes full, select Overwrite Oldest Save.
- See:** "Automatic Saving (Waveform Data and Numerical Calculation Results)"(p. 125)

- For the FTP client to control auto sending of data, the IP address of the FTP server PC must be specified.
- The Windows FTP server function can be used. Enter and register the HiLogger user name and password in the FTP server. For details about the Windows FTP server, see Internet Information Services (IIS) in Windows Help.
- Free programs such as FileZilla Server can be used in place of Windows FTP server.

General Procedure

- 1 LAN Settings and Connections (p. 178)
- 2 Set up the FTP server on the PC (p. 197)
- 3 Enable FTP auto sending on the HiLogger (p. 211 to p. 214)
- 4 Configure auto saving (p. 125).
- 5 Start measuring with the HiLogger
When auto saving a file on removable storage, the file is also sent automatically to the FTP server PC.
- 6 Check communication status (p. 215)

Setting Up an FTP Server on a PC

This section describes how to set up an FTP server on a PC using Windows XP and Windows 7 as the examples.

NOTE

- The necessary settings may differ depending on the environment. Refer to the FTP server's help as necessary or consult with your network administrator.
- You will need Windows administrator privileges in order to make these settings.

(Windows Home Edition does not include an FTP server. Instead use FileZilla Server or another freeware alternative.)

Windows7

- 1 Select **[Programs]** under **[Control Panel]**.

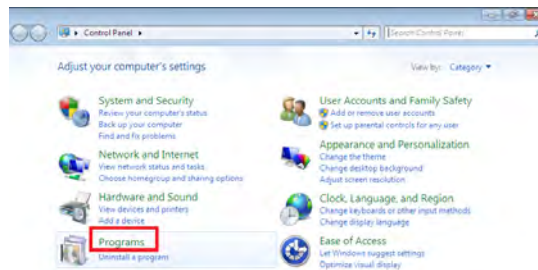

- 2 Select **[Turn Windows features on or off]**.

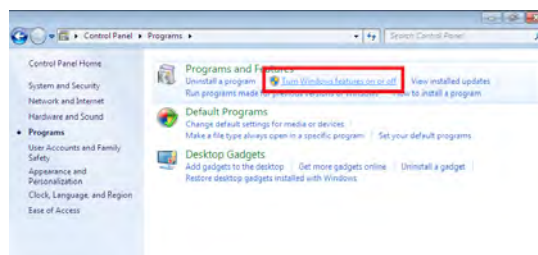

10.6 Auto Sending Data using the FTP Client Function

- 3 On Windows, click the **[+]** button to the left of **[Internet Information Services]** to expand the list of functions. Click the **[+]** button to the left of **[FTP Server]** and check **[FTP Service]**. Click the **[+]** button to the left of **[Web Management Tools]** and check **[IIS Management Console]**. Click **[OK]**.

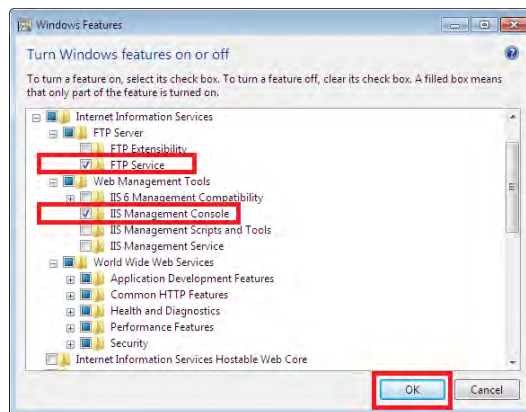

This completes the installation of the FTP server.

Configuring the FTP server

- 4 Select the **[System and Security]** control panel.

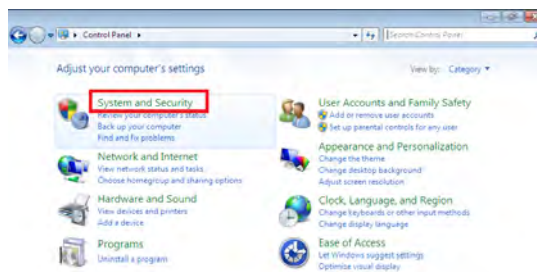

10.6 Auto Sending Data using the FTP Client Function

5 Select [Administrative Tools]

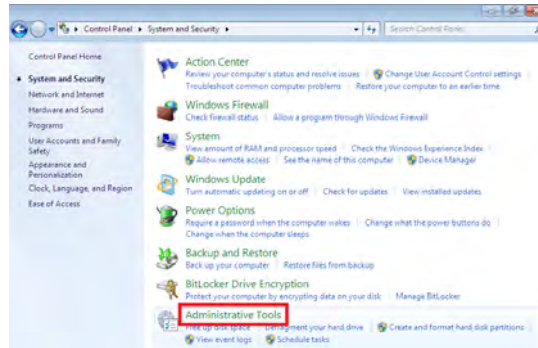

6 Select [Internet Information Services (IIS) Manager]

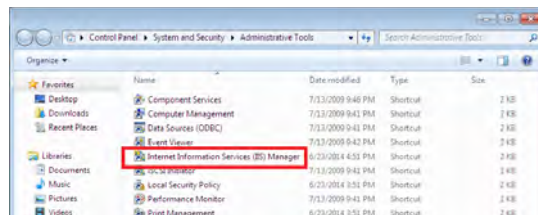

7 Select [Internet Information Services (IIS) Manager] from [AdministrativeTools].

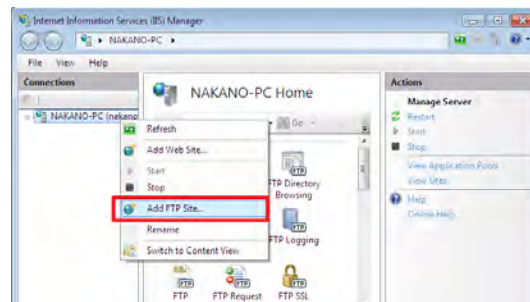

NOTE

Communications may be blocked depending on the settings for software (for example, a firewall) Used to protect the computer.

10.6 Auto Sending Data using the FTP Client Function

8 Enter the site information and click the [Next] button.

Use an FTP site name such as [ftp]. Set the directory into which you wish to save data from the FTP client as the content directory.

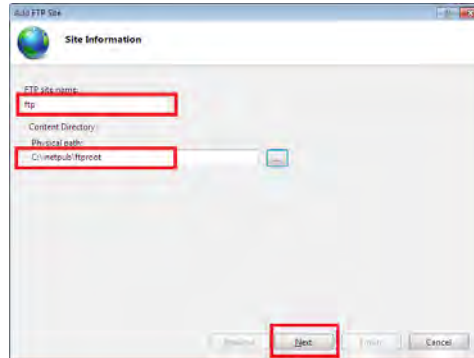

9 Configure the bind and SSL settings and click the [Next] button.

Configure the settings as follows:

Bind settings

IP address: All Unassigned

Port: 21

Start FTP site automatically: Check

SSL: No SSL

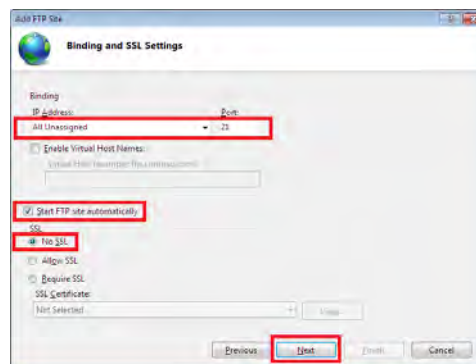

10.6 Auto Sending Data using the FTP Client Function

- 10** Enter authentication and approval information and click the **[Finish]** button.

Configure the settings as follows:

Authentication: Basic

Authorization: All users

Permissions: Check both Read and Write.

This completes the configuration of the FTP server.

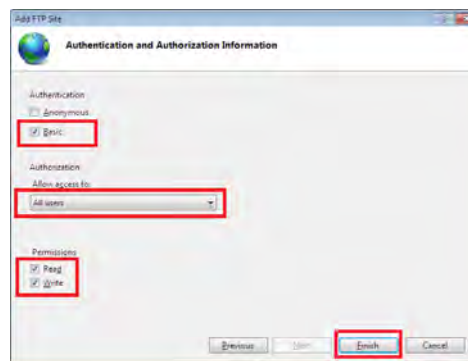

Traffic of FTP is validated by a firewall.

- 11** Select **[System and Security]** from **[Control Panel]**



- 12** Select **[Windows Firewall]**

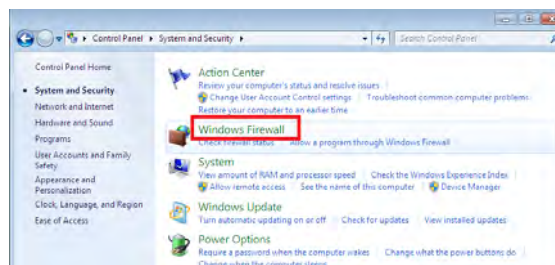

13 Select [Advanced settings]

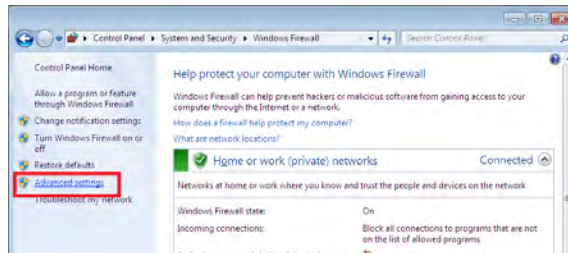

14 Select [FTP Server (FTP Traffic-In)] from [Inbound Rules] Properties

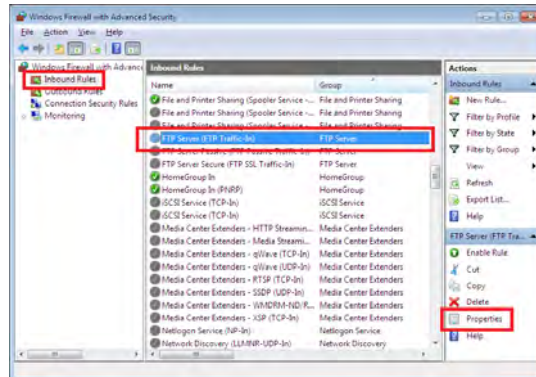

15 On the [FTP Server (FTP Traffic-In)], Select [Enable]

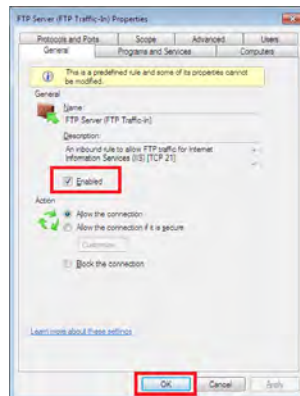

10.6 Auto Sending Data using the FTP Client Function

16 Confirm that [FTP Server (FTP Traffic-In)] is enabled, and close the dialog.

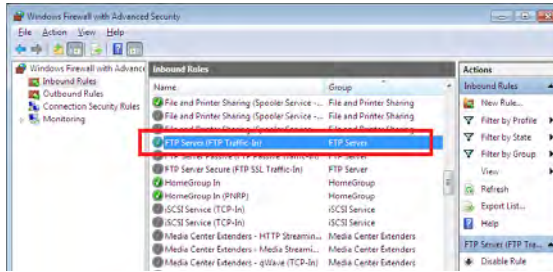

Setting the users that will access the server

17 Select [Administrative Tools] from Control Panel

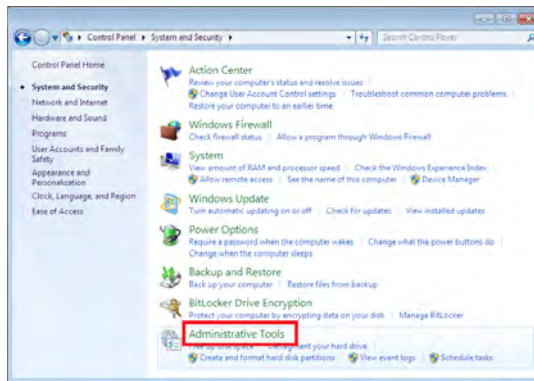

18 Select [Computer Management]

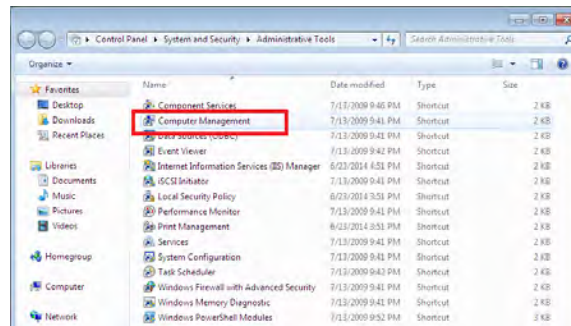

204

10.6 Auto Sending Data using the FTP Client Function

- 19 Right-click on local users and group users to display the menu and select [New User].

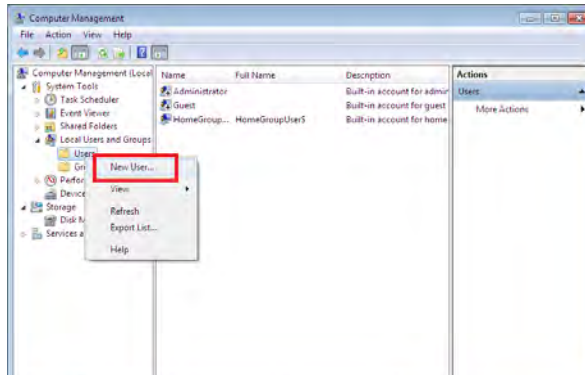

- 20 Set the user and click the [Create] button.
Set the username and password and select the [Password never expires] check box.

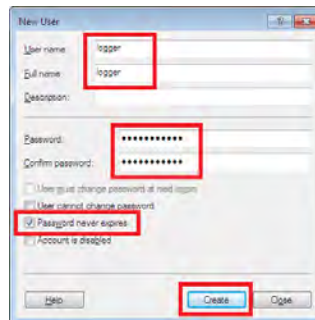

- 21 Confirm that the set-up logger is registered as the user, and close the dialog.

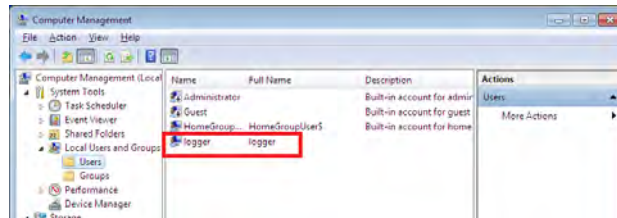

10.6 Auto Sending Data using the FTP Client Function

The access permit of the folder for FTP is set up.

22 Open C:\inetpub, right-click [ftproot], and then, select [Properties].

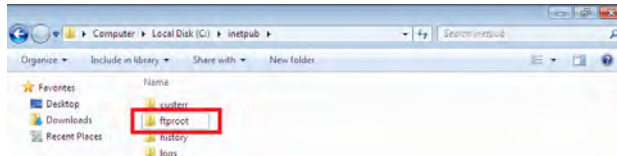

23 Select [Edit] of [Users] from [Security].

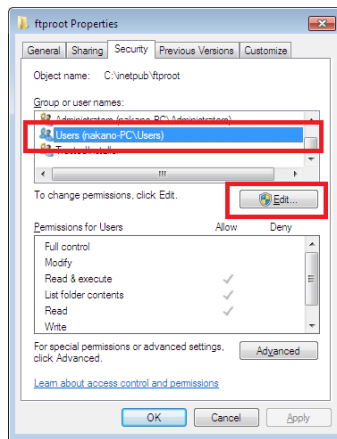

24 Open [Properties] of ftproot, Select [Edit] of [Users] from [Security].

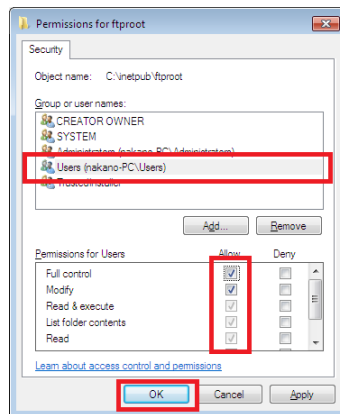

Above, a setup of FTP of Windows 7 is an end.

You can use the FTP server by using the created username and password.

10.6 Auto Sending Data using the FTP Client Function

WindowsXP Professional

1 In the [Control Panel], select [Add or Remove Programs].

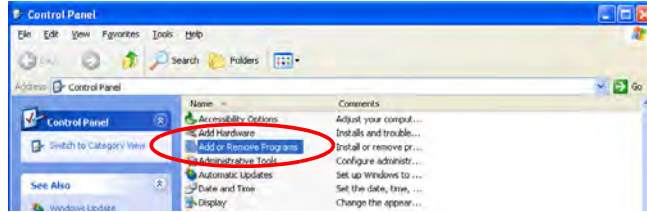

2 Select [Add/Remove Windows Components].

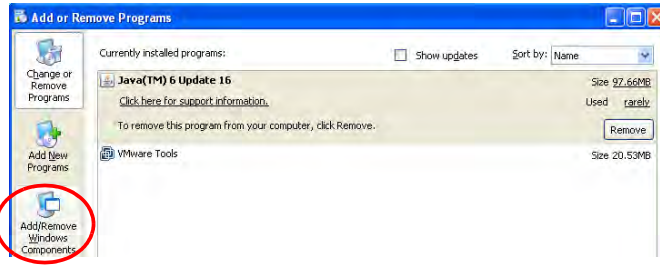

3 Select [Internet Information Services (IIS)], and then [Details].

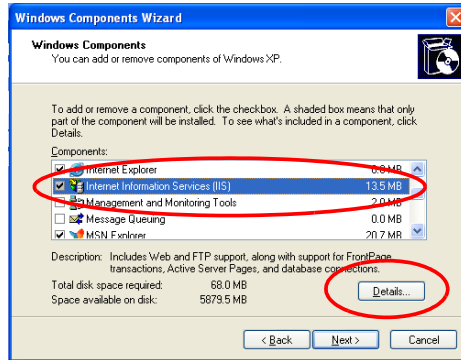

10.6 Auto Sending Data using the FTP Client Function

- 4 Select [File Transfer Protocol (FTP) Service], and click [OK].

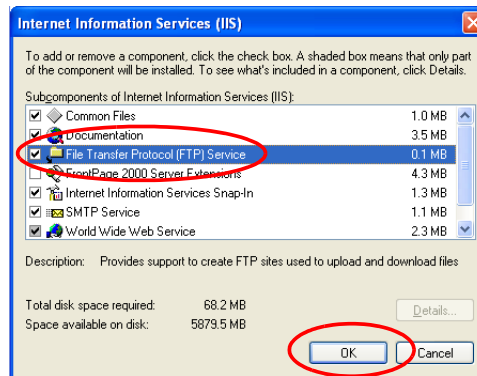

- 5 Click [Next].
At this point, your Windows XP CD is requested.

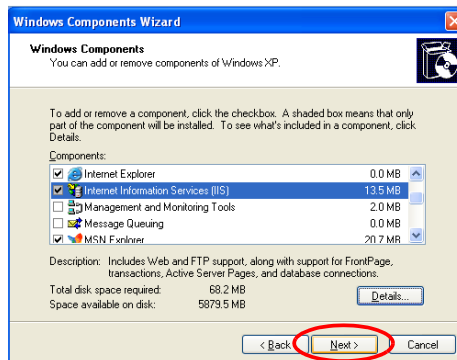

- 6 Click [Finish].



10.6 Auto Sending Data using the FTP Client Function

When installation is finished, the [InetPub] folder is created.

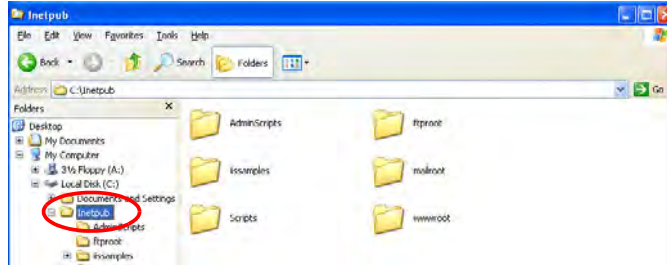

7 In the [Control Panel], select [Administrative Tools].

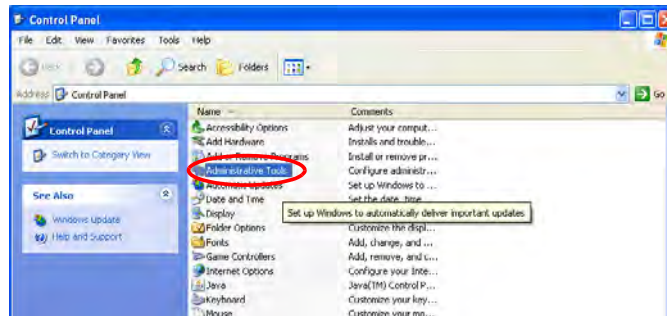

8 Select [Internet Information Services].

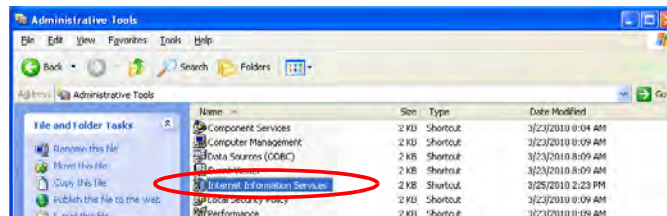

9 Select [Default FTP Site], and right click to select [Properties].

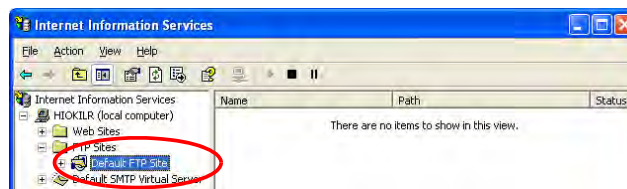

10 For the IP Address, select [(All Unassigned)].

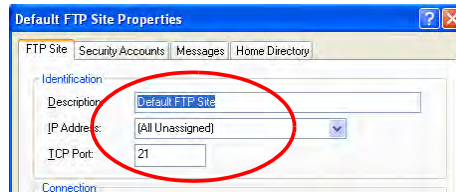

11 On the [Home Directory] tab, select [Read], [Write], and [Log visits], and click [OK].

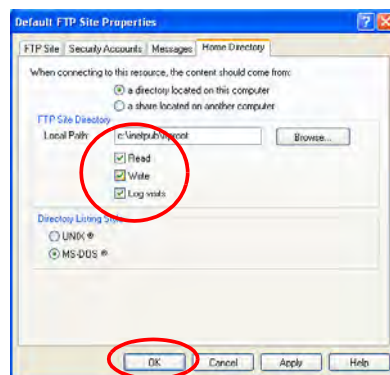

12 Back in the [Administrative Tools], select [Computer Management].

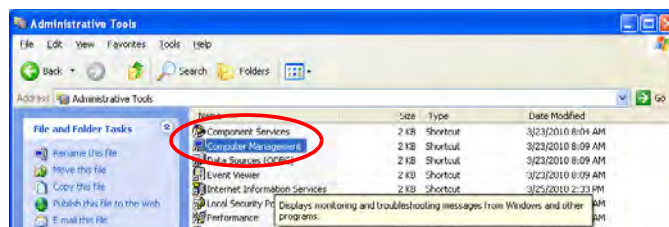

13 In [Local Users and Groups], select [Users] then right click in the right pane and select [New User].

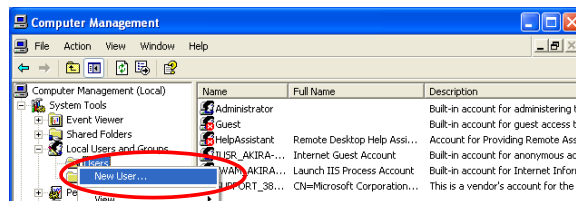

- 14 Enter a user name, full name, password and confirmation (e.g., "logger"), and click **Create**.

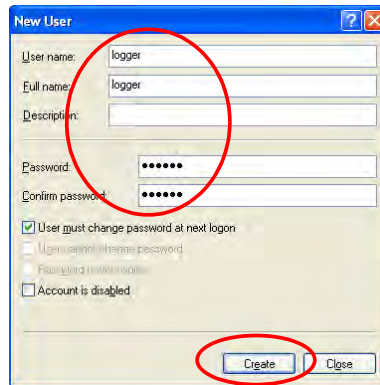

The created **logger** user is registered.

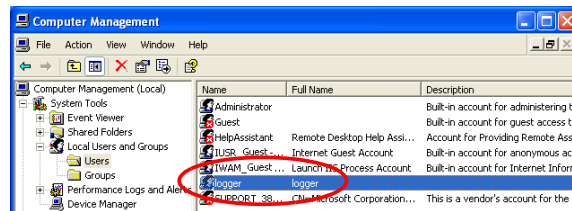

This completes FTP setup on the PC.

HiLogger Auto-Send Settings

This example illustrates sending data to an FTP server with address 192.168.1.1.

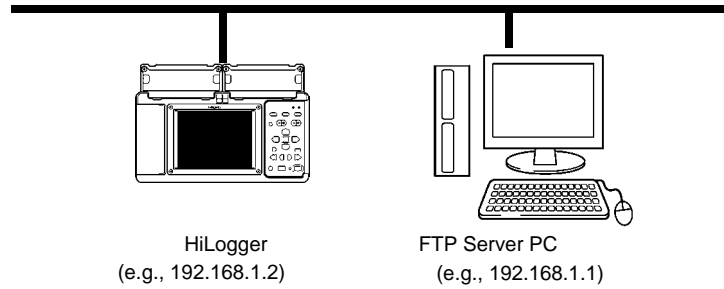

Key Setting Procedure

The screenshot shows the HiLogger menu system. Step 1 points to the "System" screen. Step 2 points to the "FTP" option in the "Communication Interface" menu. Step 3 points to the "FTP Auto Transfer" settings.

1 Select the [System] Screen.

2 Select [FTP].
[FTP] cannot be selected when the [Communication Interface] is set to [USB]. Set the communications interface to [LAN] before selecting [FTP].

3 Move to a setting item.

Open the setting options for the item to be set.

Select from the listed options.

Apply

1 Enable **[FTP Auto Transfer]** (set to On).

2 Set each item (p. 213).

3 Set the **[Time Difference]**.
If the PC clock and the HiLogger FTP server clock have different times, specify the time difference.

Setting options:
-12h to 12h (Default setting: 0h)

4 Enable **[FTP/HTTP Authentication]**.

To restrict access to the FTP server, enable FTP/HTTP authentication and set a user name and password.

Setting options: (* : default setting)

- Off*** FTP/HTTP server access is unrestricted.
- On** FTP/HTTP server access is restricted.

5 (When **[FTP/HTTP Authentication]** is enabled)

[User Name] setting

Enter the user name that will be required to access the HiLogger from an FTP client or HTTP user agent.

Setting options:

Up to 12 characters

[Password] setting

Enter the password that will be required to access the HiLogger from an FTP client or HTTP user agent.

Setting options:

Up to 12 characters

The password is displayed as
{*****}

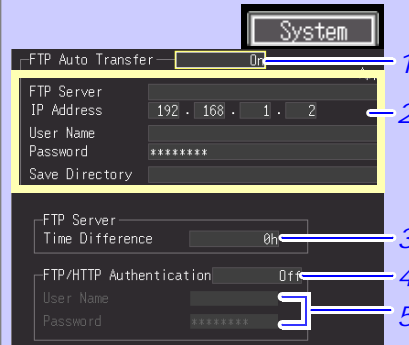

Numerical Settings

- Increment/decrement by 1
- Increment/decrement by 10

Character Settings

See:
"3.7 Entering Titles and Comments (as needed)" (p. 71)

Setting Items

- FTP Server** Enter the name of the data sending FTP server.
Setting options
Up to 32 characters
- IP Address** Enter the IP address of the data sending FTP server.
This is the IP address of the PC acting as the FTP server.
Setting options
.._._ (where _ is 0 to 255, e.g., 192.168.1.1)
- User Name** Enter the FTP server logon user name.
This is the user name of the HiLogger registered with the FTP server.
Setting options
Up to 32 characters (e.g., LOGGER)
- Password** Enter the FTP server logon password.
This is the password of the HiLogger registered with the FTP server.
Setting options
Up to 32 characters (e.g., LOGGER)
The password is displayed as "****...****" (32 asterisks (*)).
- Save Directory** Specify the destination folder for saving data on the FTP server.
Setting options
Up to 32 characters(e.g., abc)
- Append identifier to file name** Select identifiers to be prepended to file names.
Setting options
- | | |
|-------------------|--|
| Host Name | Include the host name in the names of files sent to the FTP server. |
| IP Address | Include the IP address in the names of files sent to the FTP server. |
| Date | Include a timestamp in the names of files sent to the FTP server. |
- Examples**
Host Name: LOGGER
IP Address: 192.168.1.2
Date: '10-04-01 08:30:05
Auto Save file name: AUTO0001.MEM
When the host name, IP address, and time are set as above, the file name is LOGGER_192-168-1-2_100401-083005_AUTO0001.MEM. Identification is possible when using multiple HiLoggers.
- PASV Mode** Switch it ON when using PASV mode during communication.

Testing File Transfer

Select [FTP Transfer Test].
Apply

Transfer the file FTP_TEST.TXT to C:\In-tpub\ftproot.

System

FTP Transfer Test

Communication status

Total	0
Finish	0
Miss	0
Not Yet	0

If the file sending test fails, check the HiLogger's auto-send settings and the FTP settings on the PC.

If the sending test succeeds, start measurement. Data is automatically sent to the FTP server (PC).

FTP Test

Data Transfer Timing

To calculate: transfer time (s) = file size (KB) / transfer speed (KB/s) + transfer preparation time (s).

See "Appendix 5 Binary File Size Calculation" (⇒ p. A10) for file size information.

Typical transfer speed is 300KB/s, and typical transfer preparation time is 3 s.

Example: For a 3MB (3,000KB) file,

$$\begin{aligned} \text{Transfer time} &= 3,000\text{KB} / 300 \text{ (KB/s)} + 3 \text{ (s)} \\ &= 10 + 3 \text{ (s)} \\ &= 13 \text{ (s)} \end{aligned}$$

Checking Communication Status

The communication status can be checked as follows.

The status of all FTP file transfers, the number already sent, the number that failed to send, and the number of unsent files are displayed.

Status values are reset to zero by the following:

- When pressing **START** to start measuring
- When changing LAN-related settings

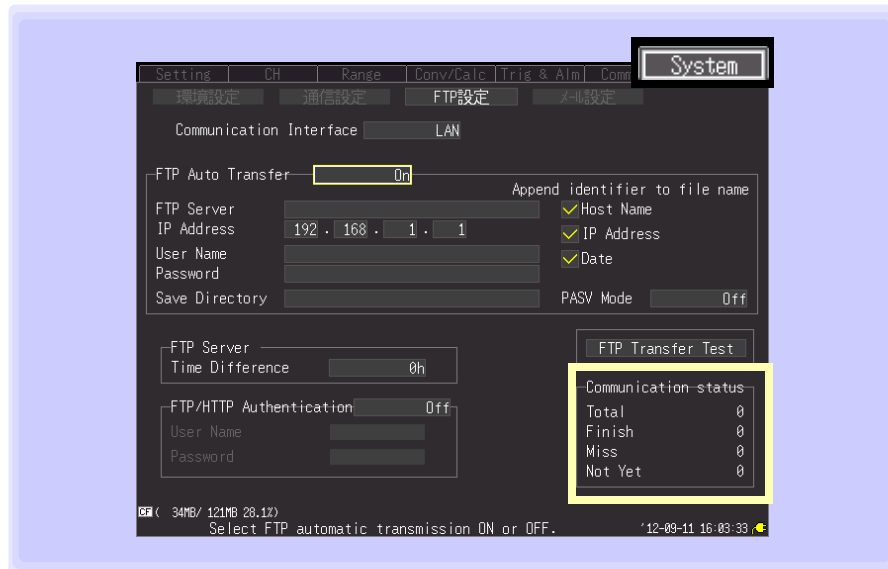

For example, Total 10, Sent (Finish) 7, Failed (Miss) 1, and Unsent (Not Yet) 2

Here, ten FTP transfers were initiated, seven of which were sent, one of which failed, and two of which are waiting to be sent.

10.7 Sending E-Mail

E-mail notifications can be automatically sent from the HiLogger when start or stop triggering occurs during measurement, and when an alarm, power outage recovery, memory-full or removable-storage-full event occurs. Notifications can be sent to a network device, remote PC, or e-mail-supporting cell phone via an SMTP mail server. Register up to three recipient addresses.

NOTE

Frequent alarm events can generate excessive e-mails. In this case, enable Alarm Hold to limit notifications to the first alarm event on each channel. (See Alarm Hold Settings on p. 111 .)

General Procedure

- 1 LAN Settings and Connections (p. 178)
- 2 HiLogger E-Mail Settings (p. 217)
- 3 Testing E-Mailing (p. 220)
- 4 Start Measuring with the HiLogger
E-mail is sent by the mail server when a trigger or alarm event occurs.
- 5 Confirming E-Mail Sending Status (p. 221)

HiLogger E-Mail Settings

This example illustrates sending mail from HiLogger logger@xyz.xx.xx to a cell phone (or PC) with address abc@xyz.xx.xx via SMTP mail server 192.168.1.100 when a Start trigger occurs.

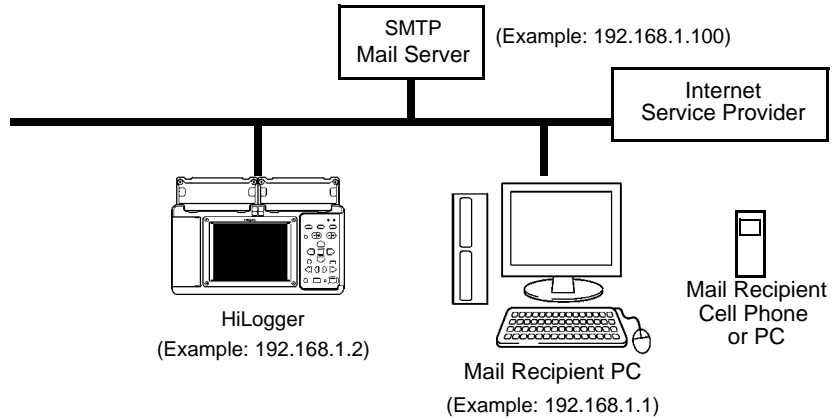

Key Setting Procedure

WAVE/DATA
SET
FILE

- 1 → Select the **[System]** Screen.
- 2 → Select **[Mail].***
- 3 → Move to a setting item.
- Open the setting options for the item to be set.
- Select from the listed options.
- Apply

The screenshot shows the 'System' menu with 'Mail' highlighted. Below it, the 'Mail' settings screen is visible, showing fields for Mail Server, IP/Port, Sender Address, Sender Name, Subject, Message, Attach data, Mail Authentication (POP Auth), Server Name (POP), IP/Port (POP), Account Name, and Password. A 'Mail Transfer Test' button is also present.

*: **[Mail]** cannot be selected when the **[Communication Interface]** is set to **[USB]**.
Set the **[Communication Interface]** to **[LAN]** before selecting **[Mail]**.

1 Enable or disable the [Send Mail to Address].

Up to three addresses can be entered.

Setting options: (* : default setting)

Off*	Mail is not sent.
On	Mail is sent.

(When [Send Mail to Address] is enabled)

2 Enter the [Send Mail to Address].

Enter the recipient's e-mail address for notifications.

Setting options:

Up to 32 characters
(e.g., abc@xyz.xx.xx)

3 Set each item (p. 219).

4 Configuring [Timing].

Select the check boxes for the desired mail sending criteria.

Setting options:

Start Trig	Send mail when a Start trigger event occurs. (for example, to notify a starting trigger)
Stop Trig	Send mail when a Stop trigger event occurs.
Alarm	Send mail when an alarm event occurs.
Start Bup	Send mail upon recovery from a power outage.
Mem Full	Send mail when HiLogger internal memory is full and old data begins to be overwritten. Mail is sent only once: the first time memory becomes full.
Card Full	Send mail when the CF card or USB flash drive becomes full.

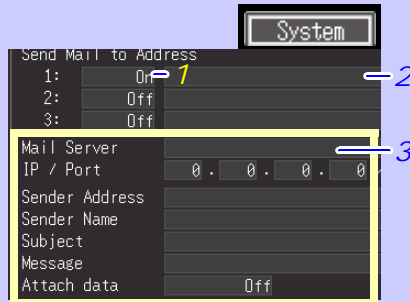

Numerical Settings

- Increment/decrement by 1
- Increment/decrement by 10

Character Settings

See:
"3.7 Entering Titles and Comments (as needed)" (p. 71)

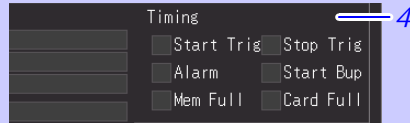

Setting Items

- Mail Server** Enter the mail server name. Specifies the SMTP mail server.
Setting options
Up to 32 characters.
- IP Address** Set the IP address of the mail server. Specifies the SMTP mail server.
Setting options
.._._ (where _ is 0 to 255, e.g., 192.168.1.100)
- IP / Port** Set the port address of the mail server. Default is port 25.
Setting options
1 to 65535
- Sender Address** Enter the sender's e-mail address.
Setting options
Up to 32 characters.
(e.g., logger@xyz.xx.xx)
- Sender Name** Enter the sender's name.
Setting options
Up to 32 characters. (e.g., logger)
- Subject** Enter the subject for mail notifications.
Setting options
Up to 32 characters. (e.g., logger_mail)
- Message** Enter the text for mail notifications.
Setting options
Up to 32 characters.
(e.g., E-mail from logger)
- Attach data** Enable/disable attachment of measurement data (Data sends only when Start trigger, Stop trigger, or alarm event occurs).
Setting options: (* : default setting)
- | | |
|-------------|---|
| Off* | Do not attach measurement data to e-mail. |
| On | Attach measurement data to e-mail. |

Testing E-Mailing

Select [Mail Transfer Test].

Apply

Sends a test e-mail.

System

Start Trig Stop Trig

Alarm Start Bup

Mem Full Card Full

0 / 25

Mail Transfer Test

Communication status

Total	0
Finish	0

If the e-mailing test fails, check your HiLogger e-mailing settings.

If the e-mailing test succeeds, you can start measurement.

NOTE

If more than 30 unsent mails accumulate, the oldest is marked as failed, and cannot be sent. Unsent mail is deleted whenever measurement starts.

E-Mail Sending Timing

Each e-mail should take about one second.

Checking Mail Communication Status

The mail communication status can be checked as follows.

The status of all mail transfers, the number already sent, the number that failed to send, and the number of unsent files are displayed.

Status values are reset to zero by the following:

- When pressing **START** to start measuring
- When changing LAN-related settings

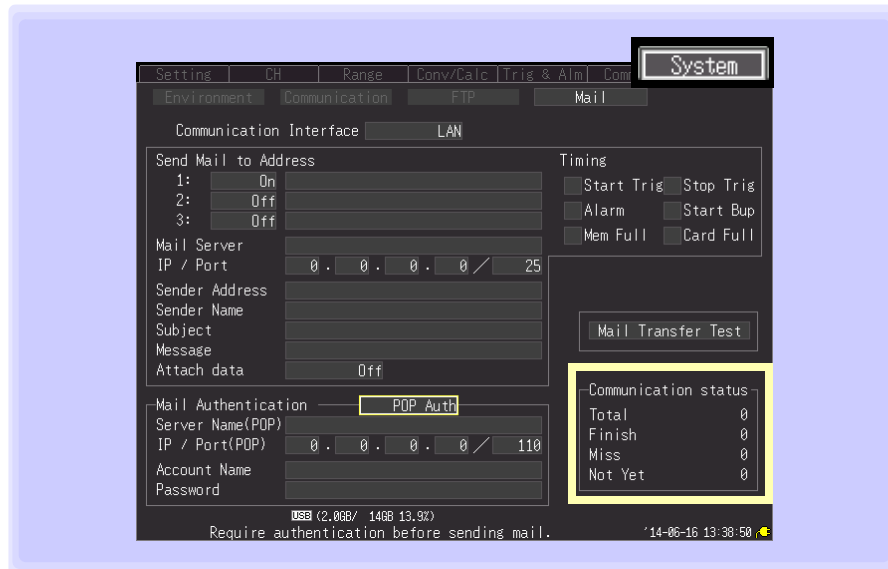

For example, Total 10, Sent (Finish) 7, Failed (Miss) 1, and Unsent (Not Yet) 2

Here, ten e-mails were initiated, seven of which were sent, one of which failed, and two of which are waiting to be sent.

E-Mail Sending Authentication

The HiLogger supports "POP before SMTP" and "SMTP" for mail sending authentication. Set as needed.

The SMTP authentication is available in the firmware version 1.27 or later.

1 Mail Authentication

OFF No authentication
 POP Auth Employs POP before SMTP
 Set Server Name, IP/Port, Account Name, Password.
 SMTP Auth Employs SMTP (supporting PLAIN and LOGIN)
 Account Name, Password.

2 Enter the [Server Name(POP)].

Enter the name of the POP3 server.

Setting options:

Up to 32 characters.

3 Set the [IP / Port(POP)].

Set the POP3 server's IP address and port number.

Setting options:

IP Address _._._._ (where _ is 0 to 255)
 Port No. 0 to 65535 (Default setting: 110)

4 Enter the [Account Name].

Enter the name of the user account for authentication.

Setting options:

Up to 32 characters.

5 Enter a [Password].

Enter the password for authentication. The password is displayed as "**** ... ****" (32 asterisks (*)).

Setting options:

Up to 32 characters.

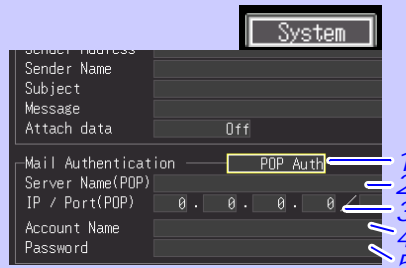

Numerical Settings

- Increment/decrement by 1
- Increment/decrement by 10

Character Settings

See:

"3.7 Entering Titles and Comments (as needed)" (p. 71)

10.8 About Communications Commands

Communications commands can be used to control the HiLogger remotely by connecting it to a PC with a USB or Ethernet cable.

This description applies only to HiLogger settings, and does not describe the communications commands themselves. For details about the communications commands, see the supplied Logger Utility CD. Communications command descriptions are provided in HTML format.

These can be viewed by the following procedure.

- 1 Insert the supplied CD in the PC's CD-ROM drive.
- 2 Click index.htm in the LR8400 folder.

See "10.1 USB Settings and Connections" (p. 166) for the USB settings and connection procedures.

See "10.2 LAN Settings and Connections (Before connecting to the network)" (p. 178) for the LAN settings and connection procedures.

Configuring Communications Command Operation

- 1 **Select the [Delimiter].**
Set as needed for command communications control.
Setting options: (* : default setting)
LF, CR+LF*
- 2 **Enable/disable the [Header].**
Enable or disable command response headers.
Setting options: (* : default setting)
On Attach headers.
Off* Do not attach headers.

See: Key Setting Procedure (p. 166)

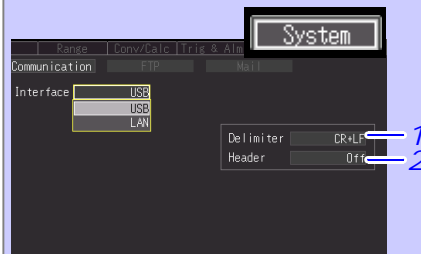

Specifications Chapter 11

Models LR8400-20, LR8401-20, and LR8402-20 are distinguished by the input units installed at the factory.

Model	UNIT1	UNIT2
LR8400-20	Voltage/Temp Unit	Voltage/Temp Unit
LR8401-20	Universal Unit	Universal Unit
LR8402-20	Universal Unit	Voltage/Temp Unit

11.1 LR8400-20, LR8401-20, LR8402-20 Memory HiLogger Specifications

(1) General Specifications

Basic Specifications

Period of guaranteed accuracy	1 year
Internal memory	8 MWords volatile RAM (SDRAM)
Clock functions	Auto calendar, auto leap year judgment, 24-hour timer
Clock accuracy	±3 s/day (@23°C)
Timebase accuracy	±0.2 s/day while measuring (@23°C, 73.4°F)
Backup battery life	Approx. five years for clock and settings (@23°C, 73.4°F)
Operating environment	Indoors, Pollution degree 2, up to 2000 m (6562-ft.) ASL
Operating temperature and humidity	0 to 40°C (32 to 104°F), 80% RH or less (non-condensating) (temperature variation range is 10 to 40°C (50 to 104°F))
Conditions of guaranteed accuracy	After 30 minutes warm-up The 50/60 Hz cut-off setting is selected (see the Cut-Off Frequency Table)
Temperature and humidity range for guaranteed accuracy	Temperature 23±5°C (73±9°F), Humidity 80% RH or less (non-condensating)
Storage temperature and humidity	Temperature -10 to 60°C (14 to 140°F), Humidity 80% RH or less (non-condensating)
Dielectric strength	3.0 kVAC for 1 minute (between each input channel and chassis) 350 VAC for 15 seconds (between input channels)
Dimensions	Approx. 272W × 182.4H × 66.5D mm (10.71"W × 7.18"H × 2.62"D) (without projections) Approx. 272W × 234.8H × 66.5D mm (10.71"W × 9.24"H × 2.62"D) (with two input units, without projections)
Mass	Approx. 1.8 kg (63.5 oz.) (LR8400-20, without 370 g battery pack) Approx. 2.6 kg (91.7 oz.) (LR8400 with two LR8500s, without 370 g battery pack)

226

11.1 LR8400-20, LR8401-20, LR8402-20 Memory HiLogger Specifications

Basic Specifications

Applicable Standards	Safety EN61010 EMC EN61326 Class A, EN61000-3-2, EN61000-3-3
Vibration endurance	JIS D 1601:1995 5.3(1), Category 1: Vehicle, Condition: Category A equiv. (45 m/s ² oscillating acceleration on X-axis for 4 h, and on Y- and Z-axes for 2 h)
External control terminals	External trigger input, trigger output, four alarm channel outputs, ground, +12 V output (@100 mA max.)

External Storage

CF card	
Slot	CompactFlash specification compliant, 1 slot
Card capacities	Hioki 9727 (256MB), 9728 (512MB), 9729 (1GB), 9830 (2GB)
Data formats	FAT, FAT32
USB flash drive	Connector: Series A receptacle
CF card/USB flash drive common functions	Files and folders can be copied between drives.

Communications Functions

LAN Interface	
LAN	IEEE802.3 Ethernet 100BASE-TX DHCP, DNS
Connector	RJ-45
LAN Function	<ul style="list-style-type: none">• Data acquisition and measurement criteria setting with the Logger Utility• Setting and measurement by communications commands• Manual file transfer by FTP server (from HiLogger memory or removable storage).• Auto sending files by FTP client (periodically transfer binary files from removable storage during or after measurement)• Remote control by HTTP server (remote control, start/stop measurement, display current values, data acquisition to memory, FTP file transfers, comment entry)• E-Mailing (send mail upon start/stop triggering, alarm events, power outage recovery, and when internal memory or removable storage is full)
USB Interface	
USB standard	USB2.0 compliant High Speed
Connector	Series-mini B receptacle
USB Function	<ul style="list-style-type: none">• Data acquisition and measurement criteria setting with the Logger Utility• Setting and measurement by communications commands• USB Drive Mode (to transfer data from CF card to a PC)

11.1 LR8400-20, LR8401-20, LR8402-20 Memory HiLogger Specifications

Display Section

Display type	5.7-in TFT Color LCD (640 x 480 dots)
Display resolution (with Waveform display selected)	Max. 15 divisions (horizontal axis (time axis)) x 10 divisions (vertical axis (voltage axis)) (1 division = 36 dots (horizontal axis (time axis)) x 36 dots (vertical axis (voltage axis)))
Display character	English/ Japanese/ French selectable
Backlight life span	Approx. 40,000 hours (@23°C, 73.4°F)
Backlight saver	The backlight turns off when no key is pressed (Off, or 1 to 5 minutes)
Backlight Brightness	Selectable from four levels (100%, 70%, 40%, 25%)

Power source

AC adapter	9418-15 AC Adapter (supplies 12 V DC \pm 10%)
Rated supply voltage	100 to 240 VAC (Voltage fluctuations of \pm 10% from the rated supply voltage are taken into account)
Rated supply frequency	50/60 Hz
Battery	Z1000 Battery Pack (The AC Adapter has priority when connected)
External Power	10 to 28 VDC (voltage variation range is 12 to 16 V)

Power consumption

Typical power consumption	With 9418-15 AC adapter or other 12 V DC external power, without battery pack w/LCD max. brightness: 7 VA (HiLogger only) w/LCD backlight off: 6 VA (HiLogger only)
Maximum rated power	When using the 9418-15 AC adapter: 70 VA (including the AC adapter), 24 VA (HiLogger only) When using an external DC16 V power source: 24 VA (when battery is charged, and w/LCD max. brightness) When using a Z1000 Battery Pack 7 VA (w/LCD max. brightness)
Continuous operating time	When using Model Z1000 Battery Pack, approx. 5 hours (Backlight brightness 25%, @23°C, 73.4°F)
Charging function	With the Z1000 Battery Pack installed and the AC Adapter connected Quick charging time: Approx. 3 hours (@23°C, 73.4°F)

Trigger Function

Trigger method	Digital comparison												
Trigger modes	Single or continuous												
Trigger timing	Start, stop, start&stop												
Trigger source													
Analog input	30 channels (U1-1 to U2-15), or up to 60 channels (U1-1 to U4-15) with additional input units												
Integrated pulse input	8 channels (P1-P8)												
Digital input	8 channels (L1-L8)												
External trigger	Trigger on external input signal rising or falling edge (selectable). <table border="0" style="width: 100%;"> <tr> <td style="width: 30%;">Rising</td> <td>: triggers upon transition from 0 to 1.0 V (LOW) to 2.5 to 5.0 V (HIGH).</td> </tr> <tr> <td>Falling</td> <td>: triggers upon transition from 2.5 to 5.0 V (HIGH) to 0 to 1.0 V (LOW), or when the external trigger terminal is shorted to a GND terminal.</td> </tr> <tr> <td>Trigger input voltage range</td> <td>: 0 to 10 VDC</td> </tr> <tr> <td>External trigger filter</td> <td>: On/Off</td> </tr> <tr> <td>Minimum response pulse width</td> <td>: H period 2.5 ms or greater, L period 2.5 ms or greater</td> </tr> <tr> <td>Trigger input terminals</td> <td>: M3 screw type terminal</td> </tr> </table>	Rising	: triggers upon transition from 0 to 1.0 V (LOW) to 2.5 to 5.0 V (HIGH).	Falling	: triggers upon transition from 2.5 to 5.0 V (HIGH) to 0 to 1.0 V (LOW), or when the external trigger terminal is shorted to a GND terminal.	Trigger input voltage range	: 0 to 10 VDC	External trigger filter	: On/Off	Minimum response pulse width	: H period 2.5 ms or greater, L period 2.5 ms or greater	Trigger input terminals	: M3 screw type terminal
Rising	: triggers upon transition from 0 to 1.0 V (LOW) to 2.5 to 5.0 V (HIGH).												
Falling	: triggers upon transition from 2.5 to 5.0 V (HIGH) to 0 to 1.0 V (LOW), or when the external trigger terminal is shorted to a GND terminal.												
Trigger input voltage range	: 0 to 10 VDC												
External trigger filter	: On/Off												
Minimum response pulse width	: H period 2.5 ms or greater, L period 2.5 ms or greater												
Trigger input terminals	: M3 screw type terminal												
Timer trigger	Set year, month, day, hour, minute, and second												
Trigger criteria	<ul style="list-style-type: none"> • AND or OR of each trigger source • Trigger criteria can be set for each channel. • Free-running when all are Off 												
Trigger types analog* and pulse													
Level Trigger	Triggering occurs when the signal rises (or falls) through a specified value.												
Window Trigger	Triggering occurs when the input signal level enters or exits the amplitude window defined by upper/lower thresholds.												
Trigger types digital													
Pattern Mask Trigger	Trigger when signals match the pattern mask (1, 0, and X) (where X is "ignore")												
Trigger level resolution	(Analog) 0.1% f.s. (f.s. = 10 divisions) (Pulse) Integration 1c, revolution 1/n (where n = pulses/rev)												
Pre-trigger	Time span setting (any span). Settable with real-time saving.												
Trigger output	Open-collector output (with 5 V output, Active Low) Pulse Width: at least 10 ms												
Trigger output terminal	M3 screw type terminal												

11.1 LR8400-20, LR8401-20, LR8402-20 Memory HiLogger Specifications

Alarm Output

Alarm Output Channels	Four, non-isolated (Common GND with HiLogger)
Output settings	Output occurs when the logical sum (OR) or product (AND) of alarm trigger sources is true.
Alarm source	
Analog input	30 channels (U1-1 to U2-15), or up to 60 channels (U1-1 to U4-15) with additional input units
Integrated pulse input	8 channels (P1-P8)
Digital input	8 channels (L1-L8)
Thermocouple burn-out	When thermocouple burn-out detection is enabled
Alarm types analog* and pulse	
Level	An alarm is output by input rising above or falling below a preset level
Window	An alarm is output by input crossing into or out of a window defined by preset upper and lower trigger levels
Trigger types digital	
Pattern Mask Alarm	Alarm when signals match the pattern mask (1, 0, and X) (where X is "ignore")
Alarm level resolution	(Analog) 0.1%f.s. (f.s. = 10 divisions) (Pulse) Integration 1c, revolution 1/n (where n = pulses/rev)
Latch setting	
Cancel Hold	Enable Alarm Hold to latch alarm output without stopping measurement.
Beeper	Built-in beeper On/Off
Output form	Open-collector output (with 5 V pull-up, active low)
Maximum switch rating	5 to 30 VDC, 200 mA
Output refresh	At every recording interval

230

11.1 LR8400-20, LR8401-20, LR8402-20 Memory HiLogger Specifications

(2) Measurement Functions

Measurement

Recording interval	10ms* ¹ , 20ms* ² , 50ms* ³ , 100ms, 200ms, 500ms, 1s, 2s, 5s, 10s, 20s, 30s, 1min, 2min, 5min, 10min, 20min, 30min, 1h
Recording length (time span)	Set continuous recording Off or On. When Off, any time can be set.
Repeating Measurement Recording	Set Off or On. When On, measurement repeats at the set recording interval.
Recording Data Quantity	Analog recording n channels: 8 M/n data values
Waveform storage	The most recent 8 million data values (one analog channel recording time, or 8 M / n values for n channels) are stored in internal memory (n = number of analog channels + pulse channels × 2 + digital channels × 1 + alarm channels × 5 words) Data retained in memory can be observed by backward scrolling.
Measurement data backup	Data is retained for about 30 minutes after power-off (except when powered off while writing to removable storage, or within five minutes after power-on)

*1: Settable for up to 15 channels (U1-1 to -15) when thermocouple burn-out is disabled.

*2: Settable for up to 30 channels (up to U2-1 to U2-15) when thermocouple burn-out disabled, or up to 15 channels (U1-1 to U1-15) when enabled.

*3: Settable for up to 60 channels (up to U3-1 to -15 and U4-1 to -15) when thermocouple burn-out is disabled, or up to 30 channels (U2-1 to -15) when enabled.

Display

Display Screen Selection (Hybrid display configurations)	<ul style="list-style-type: none">• Simultaneous waveform, gauge and setting display• Waveform display• Simultaneous waveform and numerical value display• Simultaneous numerical value and comment display• Numerical value display• Simultaneous waveforms and numerical calculation results display• Waveform and A/B cursor values displayed at the same time
Waveform colors	24 colors
Waveform compression and magnification	
Horizontal axis (time axis)	100ms, 200ms, 500ms, 1s, 2s, 5s, 10s, 20s, 30s, 1min, 2min, 5min, 10min, 20min, 30min, 1h, 2h, 5h, 10h, 12h, 1day /divisions
Vertical axis (voltage axis)	Select by position or upper/lower limits <ul style="list-style-type: none">• When selecting by position, magnification can be × 100, × 50, × 20, × 10, × 5, × 2, × 1, or × 1/2. 0 Position: Set between -50% and 150% (at 1X magnification)• When selected by upper/lower limits, specify the limit values.
Waveform scrolling	Time-axis scrolling is available by left/right arrow keys while measuring and when measurement stops (waveform drawing period).  These keys make large jumps
Jump function	Selects the displayed span of the waveform.

11.1 LR8400-20, LR8401-20, LR8402-20 Memory HiLogger Specifications

Display

Monitor function	Confirm instantaneous values and waveforms without recording data. (Monitoring is performed while triggering.)
-------------------------	--

Save

Save destination	CF card or USB flash drive selectable
Auto save	Waveform data and interval calculation results (real-time saving) Numerical calculation results other than interval calculations (after measurement saving)
Real-time saving	<ul style="list-style-type: none"> Saves waveform data in binary or CSV format to selected removable storage about once per minute (for slower recording intervals, saves every interval). Real-time saving to removable storage is possible while communicating with the Logger Utility.
Split Save	Selectable Off, On or Periodic
On	Saves data split into separate files from measurement start, at the set interval.
Periodic	Saves data split into separate files from a set reference time (within 24 hours), at the set interval.
Overwriting save	Selectable Off or On
On	Deletes the oldest file to save the newest file when removable storage becomes full.
Remove external media	During real-time saving, press a button, confirm the displayed message, and remove the storage media. When the removable media is re-inserted, data retained in internal memory is saved continuously to a separate file.
Data protection	When a power outage occurs during real-time saving, the file is closed before shutdown. When battery charge is depleted during battery operation, the file is closed.
Manual saving	Press SAVE to save. Select SAVE operation from selection or immediate saving. For immediate saving, select the save type, format, and time span.
Save types	Setting criteria, waveform data (binary format), waveform data (CSV format), numerical calculation results, screen captures (compressed bitmap format)
Reloading data	Up to 8 million data values can be saved in binary format to a specified location. (one analog channel recording time, or 8 M / n values for n channels)

Calculations

Numerical calculations	
No. of calculations	Six calculations are available at the same time
Calculations	Average value, peak value, maximum value, Time to maximum value, minimum value, Time to minimum value

Calculations

Calculation time span (After measuring)	Applies calculations to all data in internal memory, or to the time-span specified by A/B cursors.
Calculation time span (While measuring)	Applies calculations to all data in internal memory, or to the time-span specified by A/B cursors. Interval calculation: Calculates and displays the latest results at the specified interval: 1, 2, 5, 10, 20, or 30 minutes, or 1, 2, 5, 10, or 12 hours, or one day.
Auto saving calculation results	After measuring, the most recent calculation results are automatically saved in TXT format to removable storage. Interval calculation: Saves real-time calculation results in TXT format to removable storage at the specified interval.

Waveform calculations

Calculation Method	Calculate sum, difference, product, and quotient between channels, with calculated results displayed as channels Z1 to Z30 (valid only while measuring).
Auto saving calculation results	Saved in real time with a channel's waveform data.

Other Functions

Event mark function	
Search function	Displays the waveform before and after a specified event mark.
Event mark insertion	1. When pressing START while measuring 2. When pressing the on-screen [Make Mark] button. 3. When a signal is applied to the external trigger input terminal (External Trigger and Exclusive settings on the System screen) 4. When an alarm event occurs (can be enabled/disabled)
No. of Marks	Up to 100 per measurement

Cursor measurement functions

Cursor measurement	Time difference between A/B cursors, potential difference, potential at each cursor, time
Cursor display	Select All or Selected channels
Cursor movement	Select A, B, or Both (simultaneous)
Cursor types	Select trace, vertical, or horizontal
Scaling function	Scaling can be set for each channel Selectable from Ratio or 2-Point setting methods
Fahrenheit display	Scaling can be set to display Fahrenheit (F) when English language is selected.
Inter-Channel compensation function	The value measured on UNIT1, CH1 can be applied as the scaling value (only to other channels with the same input type and range).
Comment entry	Titles and comments can be entered for each channel.

11.1 LR8400-20, LR8401-20, LR8402-20 Memory HiLogger Specifications

Other Functions

Auto Resume function	Settable On or Off. When On, recording resumes automatically after a power outage. (resumes with the trigger wait state when using triggering)
Setting configuration saving function	Up to 10 setting configurations can be stored in HiLogger memory.
Auto setup function	Setting configurations can be automatically loaded from removable storage upon power-on. When setting configurations are stored on both CF card and USB flash drive, the CF card has priority.
Inadvertent START/STOP prevention	Displays a confirmation message when pressing START/STOP keys.
Confirmation message	Select enable/disable (Default: enabled)
Key-Lock function	Disables key operations (Hold cursor left and right keys for three second to enable/disable.)
Beeper	On/Off

(3) Inputs

No. of Input Channels	
Analog	30 channels Up to two measurement input units (LR8500 Voltage/Temp Unit or LR8501 Universal Unit) can be added (for up to 60 channels).
Pulse/Digital	8 channels (each channel selectable for pulse or digital input)

Analog input

Terminal block	M3 screw type terminal block (2 terminals per channel) Terminal block cover mounting* ¹ Push-button terminals (4 terminals per channel) Terminal block cover mounting * ²
Maximum input voltage	DC ± 100 V * ³
Max. inter-channel voltage	250 VDC* ¹ 300 VDC* ² (However, RTD and resistance channels are not isolated.)
Maximum rated voltage to earth	300 VAC, DC (between each input channel and chassis)* ³ Measurement category II* ³ Anticipated transient overvoltage 2500 V* ³
Measurement object	Voltage* ³ Thermocouple (K, J, E, T, N, R, S, B, W)* ³ RTDs (Pt100, JPt100) (Connection: 3- or 4-wire configuration, Measurement current: 1 mA)* ² Resistance (Connection: 4-wire configuration, Measurement current: 1 mA)* ² Humidity (Only with Hioki Z2000 Humidity Sensor)* ³

*1: LR8500 Voltage/Temp Unit only, *2: LR8501 Universal Unit only,
*3: With both LR8500 Voltage/Temp Unit or LR8501 Universal Unit

11.1 LR8400-20, LR8401-20, LR8402-20 Memory HiLogger Specifications

Measurement ranges
/Measurable Range
/Resolution
/Measurement accuracy

Measurement Object	Type	Range	Max. Resolution	Measurable Range	Measurement accuracy	
Voltage		10 mVf.s.	500 nV	-10 mV to 10 mV	± 10 μV	
		20 mVf.s.	1 μV	-20 mV to 20 mV	± 20 μV	
		100 mVf.s.	5 μV	-100 mV to 100 mV	± 100 μV	
		200 mVf.s.	10 μV	-200 mV to 200 mV	± 200 μV	
		1 Vf.s.	50 μV	-1 V to 1 V	± 1 mV	
		2 Vf.s.	100 μV	-2 V to 2 V	± 2 mV	
		10 Vf.s.	500 μV	-10 V to 10 V	± 10 mV	
		20 Vf.s.	1 mV	-20 V to 20 V	± 20 mV	
		100 Vf.s.	5 mV	-100 V to 100 V	± 100 mV	
		1-5 Vf.s.	500 μV	1 V to 5 V	± 10 mV	
Thermocouple (not including RJC accuracy) *1: JIS C 1602- 1995, IEC584	K*1	100°Cf.s.	0.01°C	-100 to 0°C or less 0 to 100°C	±0.8°C ±0.6°C	
		500°Cf.s.	0.05°C	-200 to -100°C or less 0 to 500°C	±1.5°C ±0.6°C	
		2000°Cf.s.	0.1°C	-200 to -100°C or less -100 to 1350°C	±1.5°C ±0.8°C	
		J*1	100°Cf.s.	0.01°C	-100 to 0°C or less 0 to 100°C	±0.8°C ±0.6°C
			500°Cf.s.	0.05°C	-200 to -100°C or less -100 to 0°C or less 0 to 500°C	±1.0°C ±0.8°C ±0.6°C
			2000°Cf.s.	0.1°C	-200 to -100°C or less -100 to 0°C or less 0 to 1200°C	±1.0°C ±0.8°C ±0.6°C
	E*1	100°Cf.s.	0.01°C	-100 to 0°C or less 0 to 100°C	±0.8°C ±0.6°C	
		500°Cf.s.	0.05°C	-200 to -100°C or less -100 to 0°C or less 0 to 500°C	±1.0°C ±0.8°C ±0.6°C	
		2000°Cf.s.	0.1°C	-200 to -100°C or less -100 to 0°C or less 0 to 1000°C	±1.0°C ±0.8°C ±0.6°C	
	T*1	100°Cf.s.	0.01°C	-100 to 0°C or less 0 to 100°C	±0.8°C ±0.6°C	
		500°Cf.s.	0.05°C	-200 to -100°C or less -100 to 0°C or less 0 to 400°C	±1.5°C ±0.8°C ±0.6°C	
		2000°Cf.s.	0.1°C	-200 to -100°C or less -100 to 0°C or less 0 to 400°C	±1.5°C ±0.8°C ±0.6°C	
	N*1	100°Cf.s.	0.01°C	-100 to 0°C or less 0 to 100°C	±1.2°C ±1.0°C	
		500°Cf.s.	0.05°C	-200 to -100°C or less -100 to 0°C or less 0 to 500°C	±2.2°C ±1.2°C ±1.0°C	
		2000°Cf.s.	0.1°C	-200 to -100°C or less -100 to 0°C or less 0 to 1300°C	±2.2°C ±1.2°C ±1.0°C	
	R*1	100°Cf.s.	0.01°C	0 to 100°C	±4.5°C	
		500°Cf.s.	0.05°C	0 to 100°C or less 100 to 300°C or less 300 to 500°C	±4.5°C ±3.0°C ±2.2°C	
		2000°Cf.s.	0.1°C	0 to 100°C or less 100 to 300°C or less 300 to 1700°C	±4.5°C ±3.0°C ±2.2°C	

11.1 LR8400-20, LR8401-20, LR8402-20 Memory HiLogger Specifications

Measurement ranges
/Measurable Range
/Resolution
/Measurement accuracy

Measurement Object	Type	Range	Max. Resolution	Measurable Range	Measurement accuracy
Thermocouple (not including RJC accuracy) *1: JIS C 1602-1995, IEC584 *2: ASTM E-988-96	S*1	100°Cf.s.	0.01°C	0 to 100°C	±4.5°C
		500°Cf.s.	0.05°C	0 to 100°C or less 100 to 300°C or less 300 to 500°C	±4.5°C ±3.0°C ±2.2°C
		2000°Cf.s.	0.1°C	0 to 100°C or less 100 to 300°C or less 300 to 1700°C	±4.5°C ±3.0°C ±2.2°C
	B*1	500°Cf.s.	0.05°C	400 to 500°C	±5.5°C
		2000°Cf.s.	0.1°C	400 to 600°C or less 600 to 1000°C or less 1000 to 1800°C	±5.5°C ±3.8°C ±2.5°C
		100°Cf.s.	0.01°C	0 to 100°C	±1.8°C
	W*2	500°Cf.s.	0.05°C	0 to 500°C	±1.8°C
		2000°Cf.s.	0.1°C	0 to 2000°C	±1.8°C
		100°Cf.s.	0.01°C	-100 to 100°C	±0.6°C
	RTD *3: JIS C 1604-1997, IEC751 *4: JIS C 1604-1989	Pt100 *3	500°Cf.s.	0.05°C	-200 to 500°C
2000°Cf.s.			0.1°C	-200 to 800°C	±1.0°C
100°Cf.s.			0.01°C	-100 to 100°C	±0.6°C
JPt100 *4		500°Cf.s.	0.05°C	-200 to 500°C	±0.8°C
		2000°Cf.s.	0.1°C	-200 to 500°C	±1.0°C
		10Ωf.s.	0.5mΩ	0 to 10Ω	± 10 mΩ
Resistance	20Ωf.s.	1mΩ	0 to 20Ω	± 20 mΩ	
	100Ωf.s.	5mΩ	0 to 100Ω	± 100 mΩ	
	200Ωf.s.	10mΩ	0 to 200Ω	± 200 mΩ	
	Humidity	100%rh f.s.	0.1%rh	5.0 to 95.0%rh	See Humidity Accuracy Table (includes Z2000 Humidity Sensor accuracy)

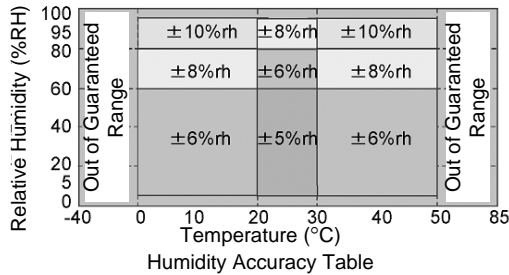

Reference junction compensation accuracy ±0.5°C
Reference junction compensation
Add to thermocouple measurement accuracy when internal RJC is enabled.

Temperature characteristic Add (Measurement accuracy x 0.1) /°C to measurement accuracy (see Humidity Accuracy Table for humidity)

Reference junction compensation Internal/External selectable (for thermocouple measurements)

11.1 LR8400-20, LR8401-20, LR8402-20 Memory HiLogger Specifications

Thermocouple burn-out detection	Enable/disable thermocouple burn-out detection at each recording interval. 5 $\mu\text{A} \pm 20\%$ detection current. No current flow when acquiring measurement data. Burn-out detection is effective for recording intervals longer than 20 ms (for up to 15 channels: U1-1 to U1-15).
Digital filter	Off, 50 Hz, 60 Hz (automatically sets the cut-off frequency according to the recording interval)
Cut-off frequency	See the Cut-Off Frequency Table (p. 237).
Input resistance	1 $\text{M}\Omega \pm 5\%$ (voltage and thermocouple measurement) 2 $\text{M}\Omega \pm 5\%$ (RTD and resistance measurement)
Normal mode rejection ratio	50dB minimum (with 50 Hz input with 5 s recording interval, and 50 Hz digital filter enabled) (with 60 Hz input with 5 s recording interval, and 60 Hz digital filter enabled) (Using up to 15 channels (U1-1 to -15) with thermocouple burn-out disabled.)
Common mode rejection ratio	with 100 Ω maximum signal source impedance 100dB minimum (with 50 or 60 Hz input and digital filter disabled) 140dB minimum (for 50-Hz input with 5 s recording interval, 50-Hz digital filter enabled, 10 mV f.s. range setting) (for 60-Hz input with 5 s recording interval, 60-Hz digital filter enabled, 10 mV f.s. range setting) (Using up to 15 channels (U1-1 to -15) with thermocouple burn-out disabled.)
Conditions of guaranteed accuracy	After 30 minutes warm-up
Temperature and humidity range for guaranteed accuracy	Temperature $23 \pm 5^\circ\text{C}$ ($73 \pm 9^\circ\text{F}$), Humidity 30 to 80% RH (non-condensating)
Effect of radiated radio-frequency electromagnetic field	$\pm 5\%$ f.s. at 3 V
Effect of conducted radio-frequency electromagnetic field	$\pm 5\%$ f.s. at 3 V/m
Pulse/Digital input	
Terminal block	M3 screw type terminal block
Input signal compatibility	Non-voltage "a" contact (normally open) open collector or voltage input
Maximum input voltage	0 to 50 VDC
Input resistance	1.1 $\text{M}\Omega \pm 5\%$
Max. inter-channel voltage	Non-isolated (HiLogger/GND Common)
Maximum rated voltage to earth	Non-isolated (HiLogger/GND Common)

11.1 LR8400-20, LR8401-20, LR8402-20 Memory HiLogger Specifications

Detecting level	2-level selectable HIGH 1.0 Vmin. LOW 0 to 0.5 V / HIGH 4.0 Vmin. LOW 0 to 1.5 V												
Measurement parameter	Pulse/digital input independently selectable for each channel												
Pulse input													
Measurement range/Resolution	<table border="1"> <thead> <tr> <th>Measurement Object</th> <th>Range</th> <th>Max. Resolution</th> <th>Measurable Range</th> </tr> </thead> <tbody> <tr> <td>Pulse Integration</td> <td>1,000 Mc pulse f.s.</td> <td>1pulse</td> <td>0 to 1,000 Mpulse</td> </tr> <tr> <td>Revolution Variation</td> <td>5,000/n [r/s] f.s n = pulses/revolution, from 1 to 1,000</td> <td>1/n [r/s]</td> <td>0 to 5,000/n [r/s]</td> </tr> </tbody> </table>	Measurement Object	Range	Max. Resolution	Measurable Range	Pulse Integration	1,000 Mc pulse f.s.	1pulse	0 to 1,000 Mpulse	Revolution Variation	5,000/n [r/s] f.s n = pulses/revolution, from 1 to 1,000	1/n [r/s]	0 to 5,000/n [r/s]
Measurement Object	Range	Max. Resolution	Measurable Range										
Pulse Integration	1,000 Mc pulse f.s.	1pulse	0 to 1,000 Mpulse										
Revolution Variation	5,000/n [r/s] f.s n = pulses/revolution, from 1 to 1,000	1/n [r/s]	0 to 5,000/n [r/s]										
Pulse input period	Without filter (Off), at least 200 μs (both H and L levels at least 100 μs) With filter (On), at least 100 ms (both H and L levels at least 50 ms)												
Slope	Either rising or falling edge pulse detection can be set for each channel												
Measurement mode	Integrated count, Revolution variation												
Integrated count	Additive: Counts cumulative (integrated) value from measurement start Instantaneous: Counts instantaneous value at every recording interval (the integration value is reset at each interval)												
Revolution variation	Counts the input pulses per second to obtain revolutions												
Anti-chatter filter	Settable On/Off for each channel												
Digital Input													
Measurement mode	Records 1 or 0 at each recording interval												

Cut-off frequency

1. With 60-Hz digital filter, and burn-out detection disabled

–: Not settable

		Recording interval													
		10 ms	20 ms	50 ms	100 ms	200 ms	500 ms	1 s	2 s	5 s	10 s	20 s	30 s	1 m	2 m or more
Cut-off frequency	Up to 15 channels*1	20.0k	13.0k	4.9k	2.4k	1.2k	60	60	60	60	60	10	10	10	10
	Up to 30 channels*2	–	20.0k	13.0k	4.9k	2.4k	1.2k	60	60	60	60	60	60	10	10
	Up to 45 channels*3	–	–	20.0k	13.0k	4.9k	2.4k	1.2k	60	60	60	60	60	60	10
	Up to 60 channels*4	–	–	–	–	–	–	–	–	–	–	–	–	–	–

[Unit: Hz]

*1. Using U1-1 to -15, *2. Using U2-1 to -15,
*3. Using U3-1 to -15, *4. Using U4-1 to -15

238

11.1 LR8400-20, LR8401-20, LR8402-20 Memory HiLogger Specifications

2. With 50-Hz digital filter, and burn-out detection disabled

--: Not settable

		Recording interval													
		10 ms	20 ms	50 ms	100 ms	200 ms	500 ms	1 s	2 s	5 s	10 s	20 s	30 s	1 m	2 or more
Cut-off frequency	Up to 15 channels*1	20.0k	13.0k	4.9k	2.4k	1.2k	50	50	50	50	50	10	10	10	10
	Up to 30 channels*2	--	20.0k	13.0k	4.9k	2.4k	1.2k	50	50	50	50	50	50	10	10
	Up to 45 channels*3	--	--	20.0k	13.0k	4.9k	2.4k	1.2k	50	50	50	50	50	50	10
	Up to 60 channels*4	--	--	--	20.0k	13.0k	4.9k	2.4k	1.2k	50	50	50	50	50	10

[Unit: Hz]

3. With 60-Hz digital filter, and burn-out detection enabled

--: Not settable

		Recording interval														
		10 ms	20 ms	50 ms	100 ms	200 ms	500 ms	1 s	2 s	5 s	10 s	20 s	30 s	1 m	2 m	5 m or more
Cut-off frequency	Up to 15 channels*1	--	20.0k	13.0k	4.9k	2.4k	1.2k	60	60	60	60	60	10	10	10	10
	Up to 30 channels*2	--	--	20.0k	13.0k	4.9k	2.4k	1.2k	60	60	60	60	60	60	10	10
	Up to 45 channels*3	--	--	--	20.0k	13.0k	4.9k	2.4k	1.2k	60	60	60	60	60	60	10
	Up to 60 channels*4	--	--	--	20.0k	13.0k	4.9k	2.4k	1.2k	60	60	60	60	60	60	10

[Unit: Hz]

4. With 50-Hz digital filter, and burn-out detection enabled

--: Not settable

		Recording interval														
		10 ms	20 ms	50 ms	100 ms	200 ms	500 ms	1 s	2 s	5 s	10 s	20 s	30 s	1 m	2 m	5 m or more
Cut-off frequency	Up to 15 channels*1	--	20.0k	13.0k	4.9k	2.4k	1.2k	50	50	50	50	50	10	10	10	10
	Up to 30 channels*2	--	--	20.0k	13.0k	4.9k	2.4k	1.2k	50	50	50	50	50	50	10	10
	Up to 45 channels*3	--	--	--	20.0k	13.0k	4.9k	2.4k	1.2k	50	50	50	50	50	50	10
	Up to 60 channels*4	--	--	--	20.0k	13.0k	4.9k	2.4k	1.2k	50	50	50	50	50	50	10

[Unit: Hz]

*1. Using U1-1 to -15, *2. Using U2-1 to -15,

*3. Using U3-1 to -15, *4. Using U4-1 to -15

11.1 LR8400-20, LR8401-20, LR8402-20 Memory HiLogger Specifications

5. With digital filter, and burn-out detection disabled

–: Not settable

		Recording interval		
		10 ms	20 ms	50 ms or more
Cut-off frequency	Up to 15 channels*1	20.0k	20.0k	20.0k
	Up to 30 channels*2	–	20.0k	20.0k
	Up to 45 channels*3	–	–	20.0k
	Up to 60 channels*4	–	–	20.0k

[Unit: Hz]

6. With digital filter disabled, and burn-out detection enabled

–: Not settable

		Recording interval			
		10 ms	20 ms	50 ms	100 ms or more
Cut-off frequency	Up to 15 channels*1	–	20.0k	20.0k	20.0k
	Up to 30 channels*2	–	–	20.0k	20.0k
	Up to 45 channels*3	–	–	–	20.0k
	Up to 60 channels*4	–	–	–	20.0k

[Unit: Hz]

*1. Using U1-1 to -15, *2. Using U2-1 to -15,
*3. Using U3-1 to -15, *4. Using U4-1 to -15

(4) Others

Accessories	• Instruction Manual (This document).....	1
	• Measurement Guide.....	1
	• Logger Utility (Data acquisition application program) CD	1
	• USB Cable	1
	• Model 9418-15 AC Adapter (with supplied power cord).....	1
Options (sold separately)	• Model LR8500 Voltage/Temp Unit	
	• Model LR8501 Universal Unit	
	• Model Z1000 Battery Pack (NiMH, 7.2 V, 4500 mA)	
	• Model 9418-15 AC Adapter (with supplied power cord)	
	• Model C1000 Carrying Case	
	• Model 9642 LAN Cable	
	• Model Z2000 Humidity Sensor	
	• Model 9727 PC Card (256MB)	
	• Model 9728 PC Card (512MB)	
	• Model 9729 PC Card (1GB)	
	• Model 9830 PC Card (2GB)	
• Model Z5000 Fixed Stand		

11.2 LR8500 Voltage/Temp Unit Specifications

Period of guaranteed accuracy	1 year
No. of Input Channels	15 channels (select voltage, thermocouple, or humidity for each channel)
Input terminals	M3 screw type terminal block (2 terminals per channel) Terminal block cover mounting
Measurement objects	<ul style="list-style-type: none"> • Voltage • Thermocouple (K, J, E, T, N, R, S, B, W) • Humidity (Only with Hioki Z2000 Humidity Sensor)
Measurement accuracy	Per connected HiLogger specification
Conditions of guaranteed accuracy	Per connected HiLogger specification
Temperature and humidity range for guaranteed accuracy	Per connected HiLogger specification
Operating environment	Per connected HiLogger specification
Operating temperature and humidity	Per connected HiLogger specification
Storage temperature and humidity	Temperature -10 to 50°C (14 to 122°F), Humidity 80% RH or less (non-condensating)
Dimensions	Approx. 128W × 52.8H × 64.5D mm (5.04"W × 2.08"H × 2.54"D) (sans protrusions)
Mass	Approx. 380 g (13.4 oz.)
Applicable Standards	Safety : Per connected HiLogger specification EMC : Per connected HiLogger specification

11.3 LR8501 Universal Unit Specifications

Period of guaranteed accuracy	1 year
No. of Input Channels	15 channels (select voltage, thermocouple, RTD, humidity, or resistance for each channel)
Input terminals	Push-button terminals (4 terminals per channel) Terminal block cover mounting
Measurement objects	<ul style="list-style-type: none"> • Voltage • Thermocouple (K, J, E, T, N, R, S, B, W) • RTDs (Pt100, JPt100, 3- or 4-wire configuration, 1 mA measurement current) • Resistance (4-wire configuration, 1 mA measurement current) • Humidity (Only with Hioki Z2000 Humidity Sensor)
Measurement accuracy	Per connected HiLogger specification
Conditions of guaranteed accuracy	Per connected HiLogger specification
Temperature and humidity range for guaranteed accuracy	Per connected HiLogger specification
Operating environment	Per connected HiLogger specification
Operating temperature and humidity	Per connected HiLogger specification
Storage temperature and humidity	Temperature -10 to 50°C (14 to 122°F), Humidity 80% RH or less (non-condensating)
Dimensions	Approx. 128W x 52.8H x 64.5D mm (5.04"W x 2.08"H x 2.54"D) (sans protrusions)
Mass	Approx. 300 g (10.6 oz.)
Applicable Standards	Safety : Per connected HiLogger specification EMC : Per connected HiLogger specification

Maintenance and Service

Chapter 12

12.1 Inspection, Repair, and Cleaning



WARNING

Touching any of the high-voltage points inside the HiLogger is very dangerous.

Do not attempt to modify, disassemble or repair the HiLogger; as fire, electric shock and injury could result.

Replaceable Parts and Operating Lifetimes

Useful life depends on the operating environment and frequency of use. Operation cannot be guaranteed beyond the following periods.

For replacement parts, contact your dealer or Hioki representative.

Part	Life
LCD (to half brightness)	Approx. 40,000 hours
Z1000 Battery Pack	Battery charge capacity is reduced to about 60% after 300 full charge/discharge cycles.
Battery pack connector	Connect/disconnect 30 times (for stable contacts)
Electrolytic Capacitors	Approx. 10 years
Lithium battery	Approx. 5 years The HiLogger contains a built-in backup lithium battery. If the date and time deviate substantially when the HiLogger is switched on, it is the time to replace that battery. Contact your dealer or Hioki representative.

Fuse

The fuse is housed in the power unit of the HiLogger. If the power does not turn on, the fuse may be blown. If this occurs, a replacement or repair cannot be performed by customers. Please contact your dealer or Hioki representative.

NOTE

Transporting

- Use the original packing materials when transporting the HiLogger, if possible.
- Pack the HiLogger so that it will not sustain damage during shipping, and include a description of existing damage. We do not take any responsibility for damage incurred during shipping.

Cleaning



To clean the HiLogger, wipe it gently with a soft cloth moistened with water or mild detergent. Never use solvents such as benzene, alcohol, acetone, ether, ketones, thinners or gasoline, as they can deform and discolor the case. And, wipe the LCD gently with a soft, dry cloth.

12.2 Troubleshooting

If damage is suspected, check the "Before Returning for Repair"(p. 244) section before contacting your dealer or Hioki representative.

Before Returning for Repair

If abnormal operation occurs, check the following items.

Symptom	Check Items	
The display does not appear when you turn the power on.	<ul style="list-style-type: none"> Is the power cord disconnected? Are connections made correctly? Is the battery pack installed correctly? 	Verify that the power cord is connected properly (p. 32). Verify that the battery pack is correctly installed (p. 30).
Keys do not work.	<ul style="list-style-type: none"> Is any key being held down? Is the key-lock state active? (A message appears when a key is pressed while key-lock is active.) 	Verify key operation. Cancel key-lock: (Hold the   cursor keys for three seconds)
Power does not turn on.	<ul style="list-style-type: none"> Check the AC adapter (if 12 V DC is not output, the adapter is faulty). A power protection component may be damaged. 	Contact your dealer or Hioki representative for service. Customers should not attempt to perform parts replacement and repair. Contact your dealer or Hioki representative for service.
A waveform does not appear when you press START .	<ul style="list-style-type: none"> Is the "Waiting for pre-trigger" message displayed? Is the "Waiting for trigger" message displayed? Is the waveform display color selection box selected ()? 	When pre-triggering is enabled, triggering is ignored until the pre-trigger portion of the waveform has been acquired. Recording starts when a trigger occurs.
No changes occur in the displayed waveform.	<ul style="list-style-type: none"> Is the measurement cable connected correctly? Is the measurement range set properly? 	Verify that the clamp sensor or connection cable is connected correctly (p. 33).
Data cannot be saved to the removal storage.	<ul style="list-style-type: none"> Is the removal storage inserted properly? Is the removal storage formatted? Is the remaining capacity of the removal storage too low? 	"Using a CF Card/USB flash drive" (p. 45)

Z1000 battery pack cannot be charged (Charging LED is not lit).	<ul style="list-style-type: none"> • Please confirm that the surrounding temperature is within 10 to 40°C range. 	The temperature allowed for charging on the HiLogger is surrounding temperature of 10 to 40°C.
	<ul style="list-style-type: none"> • Is the HiLogger stored for a long time in a plugged condition? 	The battery pack may have deteriorated and the battery life may be expiring soon. Please purchase a new battery pack. Please contact your dealer or the nearest HIOKI representative. If the HiLogger is not used for more than a month, please remove the battery pack for storage.
Time that can be used with the battery pack has become shorter.	<ul style="list-style-type: none"> • Possibility of capacity decrease due to the deterioration of the battery pack. 	The battery pack may have deteriorated and the battery life may be expiring soon. Please purchase a new battery pack. Please contact your dealer or the nearest HIOKI representative.
If the cause is unknown	<ul style="list-style-type: none"> • Try performing a system reset (p. 159). • All settings are returned to their factory defaults (p. A11). 	



12.3 Disposing of the HiLogger

The HiLogger contains a lithium battery for memory backup. When disposing of this HiLogger, remove the lithium battery and dispose of battery and HiLogger in accordance with local regulations.

Removing the Lithium Battery



To avoid electric shock, turn off the power switch and disconnect the power cord and measurement cables before removing the lithium battery.

Required tools: One Phillips screwdriver (No.1), tweezers

- 1** Verify that the power is off, and remove the measurement cables and power cord.

- 2** Turn the HiLogger over and remove the five screws affixing the lower case.

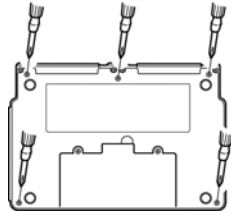

- 3** Remove the two screws in the battery compartment cover.

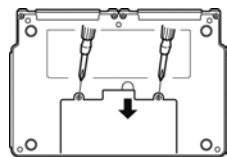

- 4** Remove the battery pack.

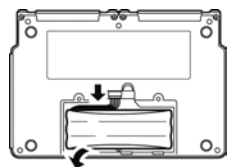

- 5** Remove the screw in the battery compartment, and remove the bottom of the case.

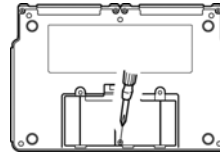

- 6** Remove the two screws in the circuit board, and remove the board.

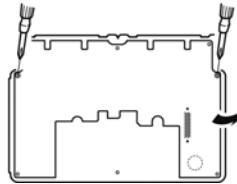

- 7** Turn the board over, and insert the tweezers between the battery holder and battery while lifting the battery to remove it.

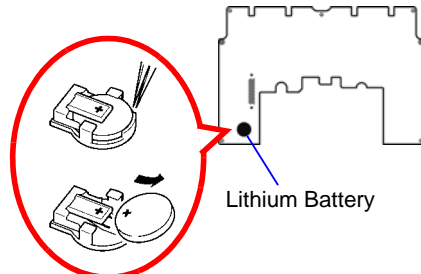

CALIFORNIA, USA ONLY

This product contains a CR Coin Lithium Battery which contains Perchlorate Material - special handling may apply.

See www.dtsc.ca.gov/hazardouswaste/perchlorate

Appendix

Appendix 1 Scan Timing

For sampling of the LR8500 Voltage/Temp Unit and LR8501 Universal Unit, there is a scan system for each channel.

In the following figures, the digital filter is Off, recording interval is 20 ms (with 2 input units), or 50 ms (with 4 input units).

With Two Input Units (max. 20 ms sampling)

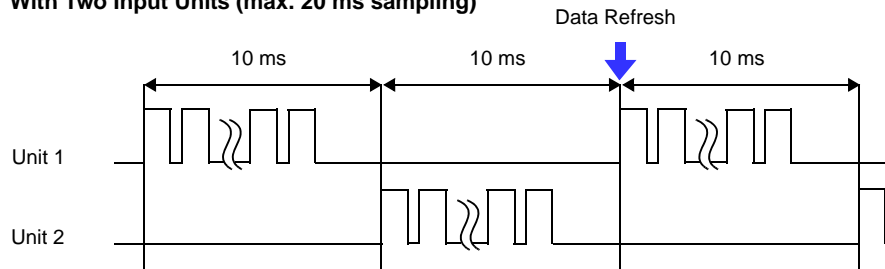

With Four Input Units (max. 50 ms sampling)

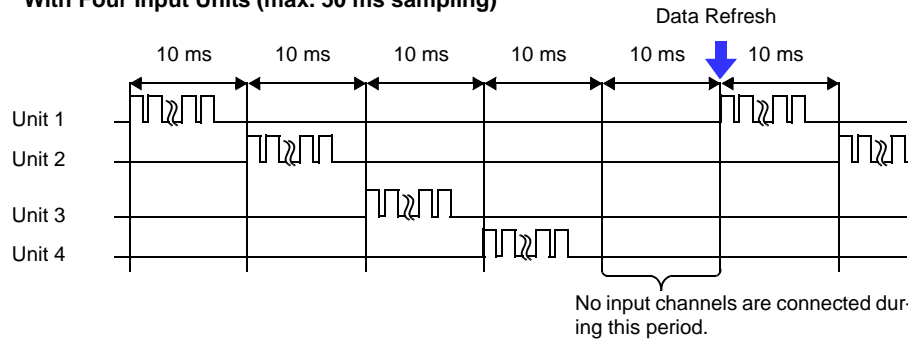

When the digital filter is off, the scan widths and dead times between channels are fixed to the values shown in the figure above regardless of the recording intervals. When the digital filter is on, the scan widths and dead times between channels vary in accordance with the recording intervals.

A2

Appendix 2 Error Messages and Remedial Actions

Appendix 2 Error Messages and Remedial Actions

Error messages consist of either "Error" or "Warning" displays.

A screen message appears whenever an error occurs. In either case, take the remedial action indicated.

Error Messages



To clear an error message, press **ENTER** or **ESC**.

Message	Remedial Action
001 Failed to back up the waveform.	Data in internal memory will be lost in about 30 min. after power outage. For long-term measurements, Auto Save to CF card or etc. is recommended to prepare for power outages. See: "What happens to data in a power outage?" (p .123)
004 Battery low. Cannot access to the waveform backup and Media.	Low battery charge: recharge or replace with a fresh battery pack.
005 FPGA error.	Incompatible FPGA firmware version. Try updating the firmware, and if the error persists, submit the HiLogger for repair.
008 FPGA PLL error. Turn off and on the power.	Measurement stopped due to FPGA internal PLL fault. Turn power off and on, check ambient conditions (temperature and noise), and try measuring again.
009 Turn off and connect UNIT in numerical order.	If input unit 4 is used while unit 3 is not, move connections to unit 3 so there is no gap between input units.
010 UNIT recognize error.	An input UNIT could not be properly recognized. Contact your dealer or Hioki representative, as it may be damaged.
011 The time of the clock was initialized.	Reset the clock. If the problem remains, have the HiLogger repaired.
012 Internal Memory recognize error.	Internal memory could not be properly recognized. Contact your dealer or Hioki representative, as it may be damaged.

Warning Messages

Appears just once when an error occurs. Disappears within a few seconds. Also disappears when any key is pressed.

Message	Remedial Action
101 Invalid key.	The pressed key is disabled due to measuring or other operation. Press the key again after the current operation finishes.
102 Cannot start measurement.	The START key is disabled when the current screen is displayed. Switch to the Waveform/Numerical screen before starting measurement.
103 Cannot change while measuring.	Press STOP to stop measuring before changing the setting.
201 Exceeding the setting range.	The entered numerical value is out of the valid range. Enter a valid value.
204 Measurement range changed.	When [Type]-[Up/Lwr] is selected, the measurement range is automatically changed to match the upper and lower limits.
230 Recording time has been changed due to memory limit.	Increasing the number of measurement channels has decreased Internal memory waveform data capacity.
231 Pre-Trigger span changed.	Increasing the recording interval or length requires reducing pre-trigger recording time.
232 Recording and Pre-Trigger spans changed due to waveform memory limit.	Increasing the recording interval requires reducing recording length and pre-trigger recording time.
233 Trigger or alarm changed.	The setting ranges for count integration and revolutions have been changed.
234 Burn Out (broken-wir) detection changed.	Burn-out detection is not available with the current settings. To enable burn-out detection, select a longer recording interval or reduce the number of channels used. See: "About the Recording Interval" (p. 52)
235 Cannot change Burn Out (broken-wire) detection.	The setting is not available due to the combination of the number of channels used and the recording interval. To enable burn-out detection, select a longer recording interval, or reduce the number of channels used. See: "About the Recording Interval" (p. 52)
236 File partition period was changed.	The segment time span has been changed in response to changing the recording interval.
237 File partition time was changed.	The segment time span has been changed in response to changing the recording interval.
238 CSV auto save has been set. Unable to set the specified record interval.	The recording intervals available for CSV auto saving are limited. Select a longer recording interval. See: "Automatic Saving (Waveform Data and Numerical Calculation Results)" (p. 125) *2

A4

Appendix 2 Error Messages and Remedial Actions

Message	Remedial Action
239 CSV auto save has been set.Unable to set the specified record interval.	Select non-CSV auto saving to measure with the specified recording interval.
240 The timer stop time has been passed.	Change the timer stop time or cancel the timer.
241 10ms recording interval cannot be set due to too many channels.	Measurement with 10 ms recording interval is available when using UNIT1-1 to -15. Disable (set to Off) channels on other input units (2 to 4).
242 20ms recording interval cannot be set due to too many channels.	Measurement with 20 ms recording interval is available when using UNIT1-1 to UNIT2-15. Disable (set to Off) channels on other input units (3 and 4).
243 Recording interval has been changed.	The recording interval has changed due to expanded channel usage.
244 Auto-save has been changed from CSV to waveform.	The saving method was changed to Waveform (binary) because the selected recording interval is too short for CSV saving. To enable CSV saving, select a longer recording interval or reduce the number of channels used. See: "Automatic Saving (Waveform Data and Numerical Calculation Results)" (p.125) *2
301 No waveform data.	No waveform data is preset, so data saving and calculations cannot be performed. Press START to start acquiring measurement data.
302 Confirm the A-B cursor position.	The A/B cursor positions are invalid (out of waveform range). Check the cursor positions.
303 No numerical calculation data.	Execute numerical calculation (p. 143)
304 Invalid event mark.	Try moving to an event mark that is not in memory.
401 File processing error.	An unexpected fault occurred while processing a file on the removal storage. Turn the HiLogger off and back on.
402 Cannot load this file.	The format of the file is incompatible with the HiLogger, or the file is corrupt. Refer to "6.1 About Saving and Loading Data" (p. 121) for loadable file formats.
403 Insert a Media.	A CF card or USB flash drive is not present. Insert storage media.
404 Directory full.	No more files can be created because the directory is full. Check or perform the following: 1. System reset (p. 159) 2. Verify that the removal storage is specified by Hioki (p. 45) 3. Reformat the removal storage (p. 47) If the message persists after performing the above, either the removal storage or HiLogger may be damaged. Contact your dealer or Hioki representative.
405 Not enough capacity.	The removal storage as insufficient space to save the file. Delete files to increase free space, or replace the removal storage.

Appendix 2 Error Messages and Remedial Actions

Message	Remedial Action
407 Insert CF card or USB memory.	A CF card or USB flash drive is not present. Insert storage media.
408 Preparing to protect files.	Allow about three minutes for the capacitor to charge.
430 Unsaved data present.	The removal storage is not inserted, or does not have enough free space. Insert a removal storage and manually save needed data.
431 Insert media to save waveform data.	Insert a removal storage.
432 Change media.	Removable storage cannot be accessed. Replace the CF card or USB flash drive.
434 Media is full or cannot delete oldest wave file.	This may appear while measuring using waveform auto save. A file could not be saved: Not enough space on the removable storage.
435 Media is nearly full.	Not enough space on the removal storage. Replace with a new removal storage.
436 Saving interrupted (Low battery).	Battery charge is too low to save. Recharge, or connect the AC adapter.
437 Saving wave data. Wait for a moment.	Some key operations are disabled because of the increased load during real-time saving. Minimize key operations as much as possible during real-time saving.
438 This folder is protected. Rename for deleting.	This message is displayed to prevent accidental deletion of data folders. To delete a folder, first rename it.
441 Insert the recording media. Unsaved data will be lost soon.	Real-time saving was attempted without removable storage, and with less than 50% internal memory available. Insert removable storage.
442 File name is too long to change.	The HiLogger cannot rename files with names longer than 26 characters. Use a PC to rename the file.
501 File system error (I/O error).	An I/O error occurred while accessing the removal storage. Reformat the removal storage. If the error persists, try a different removal storage. If this error occurs while using a good removal storage, the HiLogger may be damaged, in which case contact your dealer or Hioki representative.
502 File system error (Incorrect file handle).	Turn the HiLogger off and back on. If the fault persists, perform system reset (p. 159).
503 File system error (system configuration).	
504 File system error (not enough memory).	
505 File system error (incompleted information).	The removable storage could not be recognized. Reformat the removable storage on a PC. If the error persists, try a different removable storage. If this error occurs while using a good removable storage, the HiLogger may be damaged, in which case contact your dealer or Hioki representative.

A6

Appendix 2 Error Messages and Remedial Actions

Message	Remedial Action
506 File system error (incorrect device).	Turn the HiLogger off and back on. If the fault persists, perform system reset (p. 159).
507 File system error (file protected).	The requested write process (including deletion) could not be performed because the file attribute is read-only. Use a PC to cancel the read-only setting.
508 File system error (failed to recognize the format).	The removable storage could not be recognized. Reformat the removable storage on a PC. If the error persists, try a different removable storage. If this error occurs while using a good removable storage, the HiLogger may be damaged, in which case contact your dealer or Hioki representative.
509 File system error (limit of the number of files).	The number of files to be processed exceeds the limit, so processing cannot be performed. Delete files to increase free space, or try another removable storage.
510 File system error (same name file).	An attempt was made to create a file with the same name as an existing file. Change the name of the file to be created (p. 137).
511 File system error (system busy).	Processing could not be performed because files are in use by another executing process. Wait for the current process to finish. If there is no other executing process, turn the HiLogger off and back on.
512 File system error (too long path name).	The specified path name is too long. Re-enter the name of a removable storage folder from the PC.
513 File system error (no file).	
514 File system error (mode error).	Turn the HiLogger off and back on. If the fault persists, perform system reset (p. 159).
515 File system error (invalid file handle).	
516 File system error (file offset error).	
517 File system error (not enough capacity).	
518 File system error (invalid file name).	The file name contains an invalid character. Rename the file (p. 137).
519 File system error (directory error).	Turn the HiLogger off and back on. If the fault persists, perform system reset (p. 159).
520 File system error (invalid file type).	
521 File system error (file rename error).	
522 File system error (internal parameter error).	
523 File system error (block size error).	
524 File system error (semaphore error).	
525 File system error (not supported action).	
603 Communication error.	Check communication settings.
620 Bad MAC address.	The HiLogger's MAC address has been improperly altered. Please contact Hioki.
621 Bad IP address.	Check the IP address setting.

Appendix 2 Error Messages and Remedial Actions

Message	Remedial Action
622 Bad server IP address.	Check the server IP address setting.
623 Can not connect to server.	Check settings and connections.
625 Connection timed out.	Check the connection destination.
626 Transfer was aborted.	Check the connection destination.
627 Network error.	Check the HiLogger and connection destination.
628 Server not found or DNS failed.	Check the DNS IP address and connection.
629 DHCP failed.	Check the connections.
630 Password error.	Check the password character string. The password is case sensitive.
632 Bad FTP server IP address.	Check the IP addresses for FTP auto sending.
633 Can not connect to FTP server.	Check the FTP auto sending settings and connections.
634 Can not find FTP server/DNS failed.	Check the FTP auto sending settings, DNS IP address, and connections.
635 Bad Mail server IP address.	Check the mail server IP address setting.
636 Can not connect to Mail server.	Check the mail server settings and connections.
637 Can not find Mail server/DNS failed.	Check the mail server settings, DNS IP address, and connections.
638 Bad POP server IP address.	Check the POP server IP address setting.
639 Can not connect to POP server.	Check the POP server settings and connections.
640 Can not find POP server/DNS failed.	Check the DNS IP address and connection.
660 Can not change while communication.	This item cannot be changed by remote operation.
661 FTP Auto Transfer has been changed.	FTP auto sending settings changed due to auto-save setting change.
662 Please set Auto Save to Binary.	FTP auto sending is only available when auto saving is not binary.
663 Automatic data transfer via FTP is not possible while data is being saved.	Obtain manually the data file, if unable to be transferred, or copy the data to PC from the storage media.
664 FTP data transfer failed. File not found.	

Appendix 3 File Naming

File names are constructed as follows (must be exactly eight characters, not including extension).

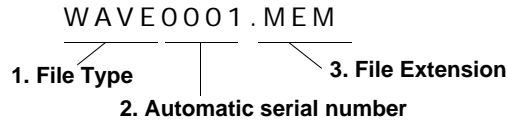

File Type	Folder Name	1. File Type	2. Automatic serial number	3. File Extension
Settings Data	CONFIG	CONF	0001,... 99999999	.SET
Waveform Data	DATA (Folders named by date are automatically created) *2	Manual Save: WAVE Auto Save: (specified name) or AUTO	0001, ...99999999 *1	.MEM (Binary) .CSV (Text) *3, *4
Numerical Calculation Results (calculation results from start to stop)	MEASUREMENT/ALL	Manual Save: MEAS Auto Save: (specified name) or AUTO	When [N-Calc. Data Saving] on the System screen is set to [Single file] : 0001 to any available number When [N-Calc. Data Saving] on the System screen is set to [Split save] : Calculations 1 to 6 are included in files with _1 to _6 appended to the serial number (0001 to any available number).	.CSV *3, *4
Numerical Calculation Results (calculation results for each split interval when split calculation is enabled)	MEASUREMENT/PART			.CSV *3, *4
Captured Screen Image	PICTURE	SCR	00001...99999999	.BMP

*1 When auto saving waveform data and calculation results, automatically generated serial numbers (up to eight digits) are appended to the specified file name. If no file name is specified, AUTO is automatically entered.
(XXXX0001.MEM, XXX00001.MEM, XX000001.MEM, X0000001.MEM)
When auto numbering exceeds 9999, the file name characters are overwritten (right to left) until all eight digits are used for serial numbers. (Example: WAVE9999.MEM, WAV10000.MEM, ..)

*2 When **[Deleting]** is enabled with auto save, the oldest waveform file is deleted when the CF card is full. When all waveform files within a date folder have been deleted, the folder name (date) is automatically updated.
(Example:) Before updating: 08-07-17
After updating: 08_07_17_080719_101113 (old date_new date_new day and time)
Hyphens (-) are changed to underbars (_) and the date when the folder name was last changed is appended. (The example shows a new date and time of July 19th 2008, 10:11:13.)

*3 The TXT file extension is applied except when **[Separator:Comma]** is selected on the **[System]** screen.

*4 Before loading data into a spreadsheet program such as Excel, note that the number of rows that can be loaded at one time is limited (to 60,000 rows in Excel 97 – 2003, and to one million rows in Excel 2007).
Larger CSV files can be split by the following methods:
•Use a CSV file-splitting program (downloadable for free from Hioki's website).
•Before saving, select the **[Split Save]** saving method in the HiLogger.
Note: The number of rows recorded per minute with 10 ms recording interval is:
100 (data points per second) x 60 (seconds) = 6,000 rows

Appendix 4 Text File Internal Format

Text files consist of header and data portions.

The header includes the following information related to measurement data.

- (1) File name and version, (2) Title comment, (3) Start trigger time,
- (4) Channel number of each line, (5) Measurement contents, (6) Range,
- (7) Comment, (8) Scaling setting, (9) Scaling ratio, (10) Scaling offset,
- (11) Channel number and input unit of each line

```
"File name","AUTO0001.CSV","V 1.00a" *****(1)
"Title comment","" *****(2)
"Start trigger time","09-12-16 13:52:32" *****(3)
"CH","A 1- 1","P 1","P 2","LOGIC-3","ALM-1","ALM-2","ALM-3","ALM-4","ALM-SOURCE-1","ALM-
SOURCE-2","ALM-SOURCE-3","ALM-SOURCE-4","Z 1", *****(4)
"Mode","Voltage","Count","Revolve","Logic","Alarm","Alarm","Alarm","Alarm Source","Alarm
Source","Alarm Source","Alarm Source","Alarm Source","Calculation", *****(5)
"Range","1V","1000000000c","5000r/s",,,,,,,,,,,,,, *****(6)
"Comment",,,,,,,,,,,,,,,,,,,,,,,,,,,,,,,,, *****(7)
"Scaling","OFF","OFF","OFF", *****(8)
"Ratio"," 1.00000E+00"," 1.00000E+00"," 1.00000E+00", *****(9)
"Offset"," 0.00000E+00"," 0.00000E+00"," 0.00000E+00" *****(10)
"Time","1-1[V]","P-1[c]","P-2[r/s]","IN-3","ALM-1","ALM-2","ALM-3","ALM-4","ALM-SOURCE-1","ALM-
SOURCE-2","ALM-SOURCE-3","ALM-SOURCE-4","CALC-1[V]","Event", *****(11)
0.000000000E+00, 1.21000E-02, 0.000000000E+00, 0.000000000E+00,1,0,0,0,,"",,,,,,
2.4200000000E-02,0,
1.000000000E-01, 1.17000E-02, 0.000000000E+00, 0.000000000E+00,1,0,0,0,,"",,,,,,
2.3400000000E-02,0,
2.000000000E-01, 1.15000E-02, 0.000000000E+00, 0.000000000E+00,1,0,0,0,,"",,,,,,
2.3000000000E-02,0,
3.000000000E-01, 1.16500E-02, 0.000000000E+00, 0.000000000E+00,1,0,0,0,,"",,,,,,
2.3300000000E-02,0,
4.000000000E-01, 1.16500E-02, 0.000000000E+00, 0.000000000E+00,1,0,0,0,,"",,,,,,
2.3300000000E-02,0,
5.000000000E-01, 9.05000E-03, 0.000000000E+00, 0.000000000E+00,1,0,0,0,,"",,,,,,
1.8100000000E-02,0,
6.000000000E-01, 1.20500E-02, 0.000000000E+00, 0.000000000E+00,1,0,0,0,,"",,,,,,
2.4100000000E-02,0,
7.000000000E-01, 9.45000E-03, 0.000000000E+00, 0.000000000E+00,1,0,0,0,,"",,,,,,
1.8900000000E-02,0,
8.000000000E-01, 9.60000E-03, 0.000000000E+00, 0.000000000E+00,1,0,0,0,,"",,,,,,
1.9200000000E-02,0,
9.000000000E-01, 9.80000E-03, 0.000000000E+00, 0.000000000E+00,1,0,0,0,,"",,,,,,
1.9600000000E-02,0,
1.000000000E+00, 1.00500E-02, 0.000000000E+00, 0.000000000E+00,1,0,0,0,,"",,,,,,
2.0100000000E-02,0,
```

A10

Appendix 5 Binary File Size Calculation

Appendix 5 Binary File Size Calculation

(Byte units)

File size = Header size + Data size

Header size = Text header size + Binary header size

Text header

size = $512 \times (4 + \text{no. of analog channels} \times 3 + \text{no. of pulse channels} \times 3 + \text{no. of logic bits} \times 3 + \text{no. of alarm channels} \times 3 + \text{no. of waveform calculations} \times 3)$

Binary header

size = $512 \times (12 + \text{no. of analog channels} \times 3 + \text{no. of pulse channels} \times 3 + \text{no. of logic bits} \times 1 + \text{no. of alarm channels} \times 20 + \text{no. of waveform calculations} \times 3)$

Data size = $(\text{no. of analog channels} \times 2 + \text{no. of pulse channels} \times 4 + \text{no. of logic channels} \times 2 + \text{no. of alarm channels} \times 58 + \text{no. of waveform calculations} \times 8) \times \text{no. of data points}$

Notes

The no. of logic channels can be either 0, or 1 when using logic.

The no. of logic bits can be 0 to 8.

The no. of alarm channels can be either 0, or 1 when using alarms.

You can check an estimate of the remaining time available on the attached CF card/ USB flash drive on the [\[Setting\]](#) screen.

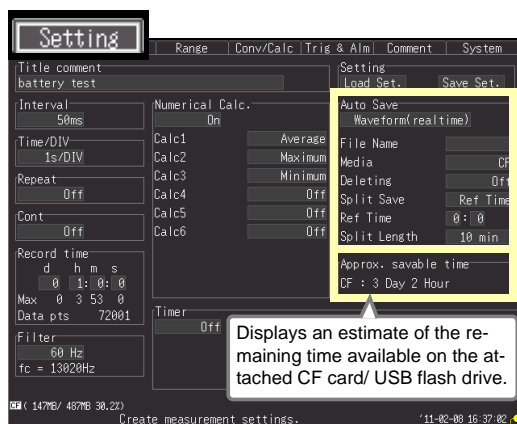

Appendix 6 List of Default Settings

When shipped from the factory or initialized to factory defaults, the settings are as follows.

Screen	Setting Item	Default Setting
Setting	Interval	20ms (50 ms when initialized with expansion input units installed)
	Filter	60Hz
	Time/DIV	100ms/DIV
	Cont	On
	Repeat	Off
	Numerical Calc.	Off
	Calc1,2,3,4,5,6	Off
	Timer	Off
	Auto Save	Off
	CH	On/Off
Input		Voltage
Range		10mV
Thermocouple		K
Burn Out		Off
RJC		Int
Count Mo		Add
Pulse/Rev		1
Slope		↑
Disp Span		Pos
Zoom		Voltage/Revolve: x1, Tc: x1
0 Pos		Voltage: 50%, Tc/Revolve: 0%
Upper		Voltage: 0.005, Tc: 100, Count/Revolve: 5000
Lower		Voltage: -0.005, Tc/Count/Revolve: 0
Scaling		Off
Start Trig.		Off
Stop Trig.		Off
Alarm1, 2, 3, 4		Off

Screen	Setting Item	Default Setting
Trig & Alm	Trig Func	Off
	Timing	Start
	Trig Source	
	Start	OR
	Stop	OR
	Ext trig	
	Start	Off
	Stop	Off
	Pre-Trig	0d 0h 0m 0s
	Alarm Source	Off
	ALM1, 2, 3, 4	OR
	System	Start Backup
File Protection		Low
Backlight saver		OFF
Backlight Brightness		100%
Display Color		Black
Beep Sound		ON
Time Disp		Time
Language		English
External Trig In		Trigger
Starg/Stop message		ON
Decimal Mark		Dot
Separator		Comma
N-Calc. Data Saving		Single file
Event mark for alarm		OFF
SAVE Key Operation		Select & Save

A12

Appendix 7 Maximum Recordable Time

Appendix 7 Maximum Recordable Time

Maximum recording time can be obtained with the following formula when saving binary waveform files to removable storage.

Max. recording time = Storage capacity*1 x recording interval (seconds) / (data size from Appendix 5)

*1. For internal memory, 16 x 1024 x 1024

The following maximum recording times are for the case of 30 analog measurement channels (with no pulse measurement, alarm outputs, or waveform calculations). The waveform file header is not included, so use about 90% of the values in the following table to estimate actual sizes.

The maximum recording time is longer when fewer channels are recorded.

Interval	Storage capacity				
	HiLogger's internal memory (16 MB)	9727 (256 MB)	9728 (512 MB)	9729 (1 GB)	9830 (2 GB)
20ms	1h 33min	1d 51min	2d 1h 42min	4d 3h 25min	8d 6h 50min
50ms	3h 53min	2d 14h 8min	5d 4h 16min	10d 8h 33min	20d 17h 6min
100ms	7h 46min	5d 4h 16min	10d 8h 33min	20d 17h 6min	41d 10h 12min
200ms	15h 32min	10d 8h 33min	20d 17h 6min	41d 10h 12min	82d 20h 24min
500ms	1d 14h 50min	25d 21h 22min	51d 18h 45min	103d 13h 30min	207d 3h 1min
1s	3d 5h 40min	51d 18h 45min	103d 13h 30min	207d 3h 1min	(1 year or more)
2s	6d 11h 20min	103d 13h 30min	207d 3h 1min	(1 year or more)	(1 year or more)
5s	16d 4h 21min	258d 21h 47min	(1 year or more)	(1 year or more)	(1 year or more)
10s	32d 8h 43min	(1 year or more)	(1 year or more)	(1 year or more)	(1 year or more)

Appendix 8 Concerning Noise Countermeasures

Mechanism of Noise Introduction into Thermocouple Temperature Measurements

What are the sources of noise?

Within a factory, power is provided by large current flows at 50/60Hz. The main loads are primarily L loads, such as motors and solenoids; in addition, large current pulses are produced by capacitor input-type switching power supplies for device such as inverters and high-frequency induction furnaces. Basic wave component leak current, harmonic wave current, and other types of noise become mixed into the flow from each ground point to ground lines.

What are the paths of noise propagation?

- Common mode voltage introduced between the ground points of the device being tested and the HiLogger leaks to the input signal lines
- AC magnetic fields produced by current in power lines couple into loops in the input signal lines
- Coupling due to electrostatic capacitance between input signal lines and power supply lines

What is common mode noise?

Noise that is generated between ground and the "+" and "-" input terminals of the HiLogger.

What is normal mode noise?

Inter-line noise that is generated between the "+" and "-" input terminals of the HiLogger.

Example of Connections Where Noise Can Affect Measurements

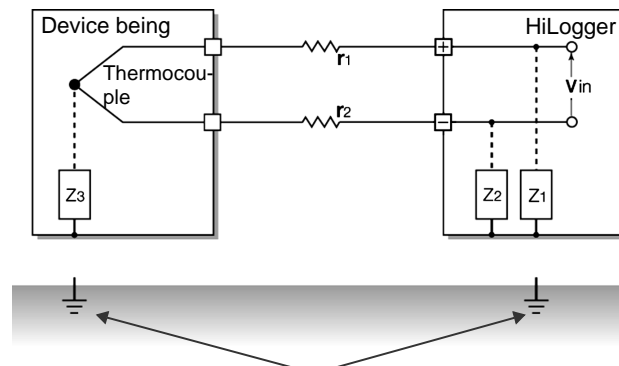

When using a thermocouple to measure temperature, noise can affect measurements unless both the device being tested and the HiLogger are grounded. Although there is no problem if the HiLogger is running on battery power, the HiLogger must be connected to ground if an AC adapter is being used.

Equivalent Circuit of Noise Introduction Path

Measurements are directly affected by normal mode voltages from electromagnetically induced noise resulting from electromagnetic coupling into looped HiLogger input lines by AC magnetic fields produced by inverters and commercial power lines, as well as the capacitive coupling that results from interline capacitance.

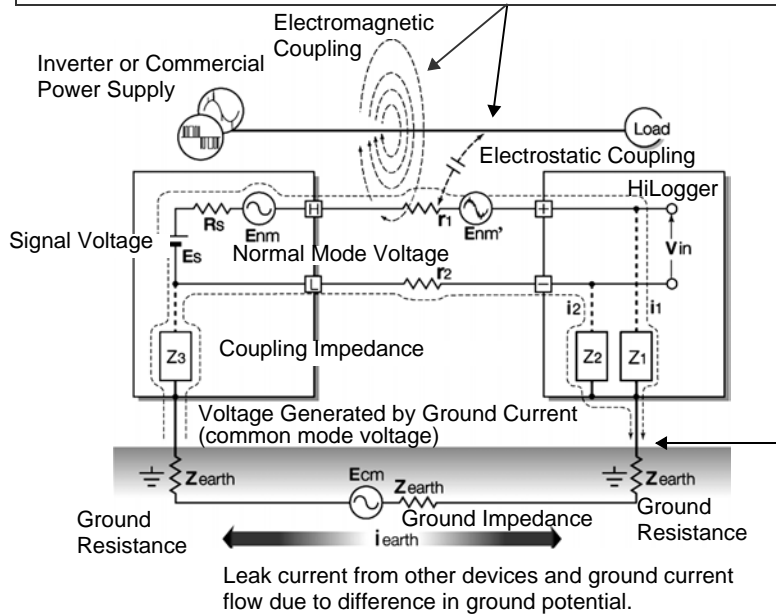

Common mode noise results from the interposition of ground impedance between the ground point of the device being tested and the ground point of the HiLogger, and from capacitor coupling between the ground wire and noise source. Common mode noise is converted to normal mode voltage (E_{nm}) that is added to the "+" and "-" input terminals of the HiLogger as a result of the noise current (i_1) and (i_2) that flows to the coupling impedance (Z_1) and (Z_2) between the "+" and "-" input terminals of the HiLogger and ground. Because common mode noise is generated between the input pins, it has a direct effect on the measurements.

Noise Countermeasure Example

1st. The Importance of Device Grounding

Ground the HiLogger securely

The HiLogger is designed so that the chassis is grounded when the three-prong power cord from the adapter is plugged directly into a grounded, three-prong receptacle.

If a three-prong-to-two-prong adapter must be used on the AC adapter power cord and therefore the HiLogger is not grounded, the HiLogger can still be grounded by connecting a grounded wire to the GND terminal (a M3 screw type terminal) located on the external control terminals of the HiLogger.

Securely ground the chassis of the device being tested

Securely connect the chassis of the device being tested to a good ground.

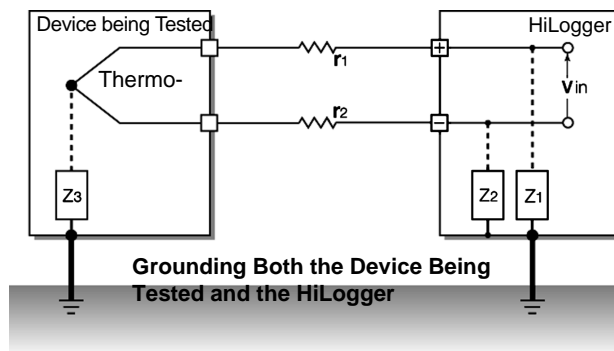

Connecting the chassis GND on the signal side to the HiLogger chassis

When connecting the chassis ground of the HiLogger to the chassis ground of the device being tested and then to ground, use a wire that is as short and as thick as possible to bring both pieces of device to equal potential.

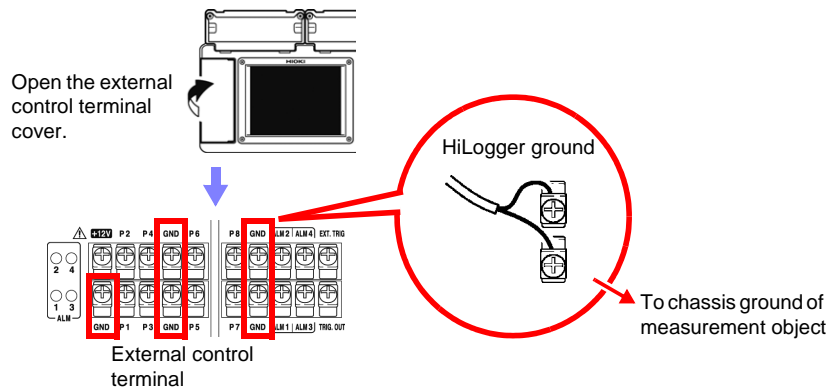

A16

Appendix 8 Concerning Noise Countermeasures

Running the HiLogger on battery power

When the HiLogger is being powered by batteries and the AC adapter is not connected, the ground current loop is eliminated, making it possible to reduce the effects of common mode noise.

For measurements of short duration, powering the 8430-20 with batteries is an effective method for eliminating noise.

Common Mode Noise Countermeasures

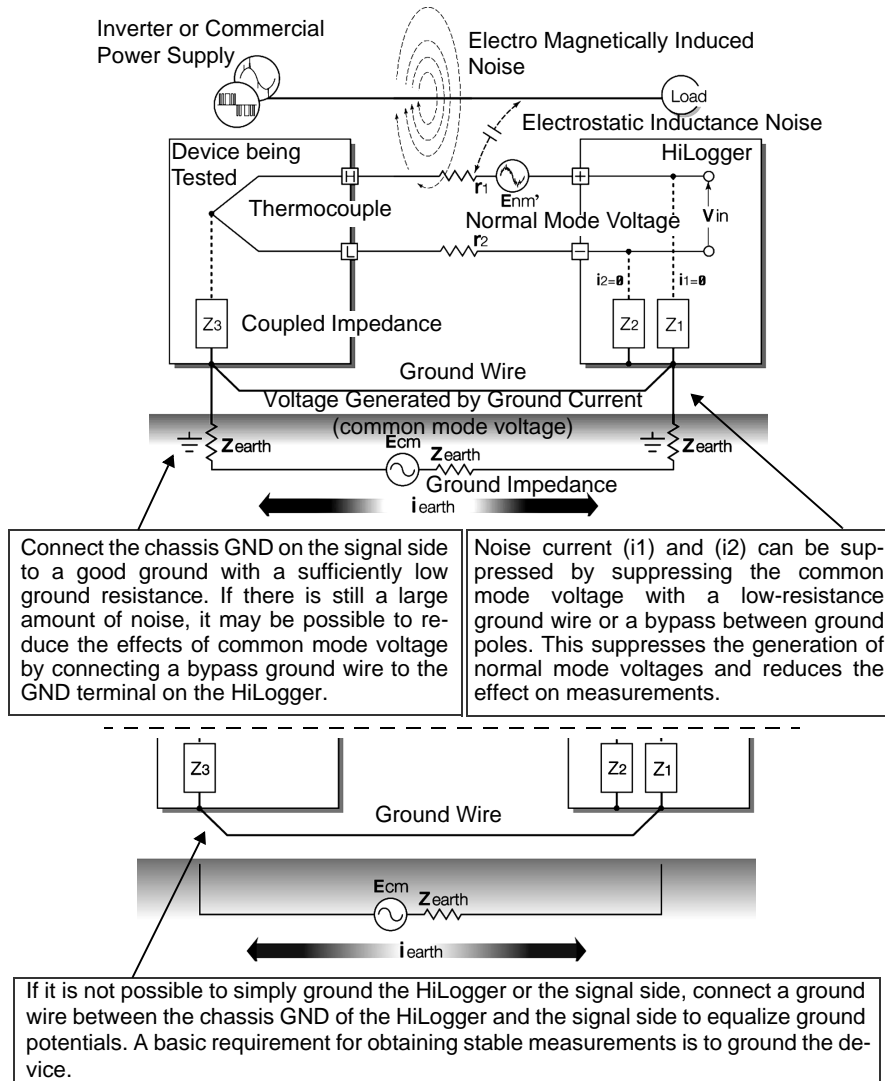

2nd. Blocking Noise from External Sources

Keep signal lines away from noise sources

Keep input signal lines (of the thermocouple) away from wiring that is a noise source (such as power lines, etc.), and make any permanent installation with as much separation as possible; for example, by running wires through a separate duct.

Use shielded twisted pair wiring

It is effective to use shielded twisted pairs for the input signal lines (of the thermocouple). Twisted pairs are effective for preventing electromagnetic induction, and shielded wires are effective for preventing electrostatic induction.

The shielded wires should basically be grounded on the signal source side. If it is not possible to connect the signal source to ground, connect it to the chassis GND on the 8430-20. Note that doing so has no effect if the 8430-20 is not itself connected to ground through the three-prong power cord, etc.

Shielded twisted pair wires for the thermocouple can be obtained from thermocouple manufacturers.

Normal Mode Noise Countermeasures

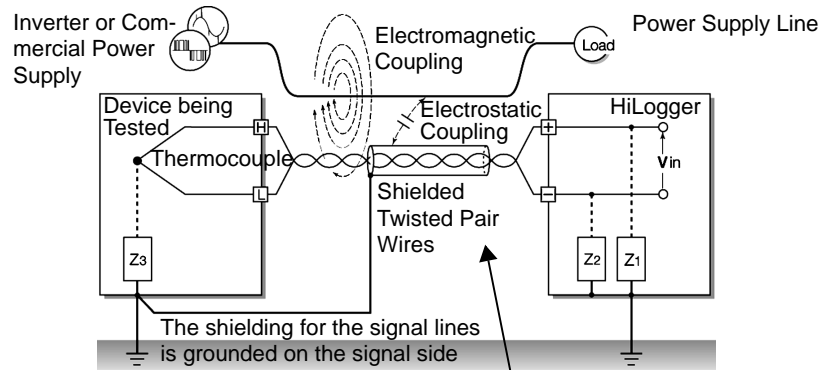

Keep the signal lines (of the thermocouple) away from wiring that is a noise source (such as power lines, etc.). It is also possible to shield the signal lines from electrostatic coupling and to block noise by grounding the shield.

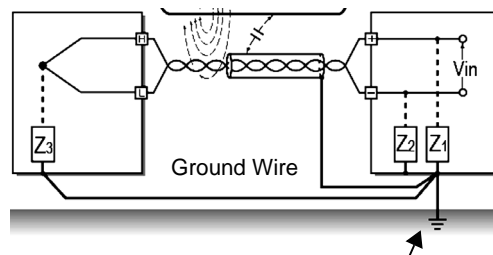

If the signal side is not grounded or if it is grounded inadequately, connect the HiLogger to ground. Also ground the shielding for the signal wires on the HiLogger side securely.

A18

Appendix 8 Concerning Noise Countermeasures

Insulation from noise sources (temperature measurement by thermocouple)

The analog input channels are insulated from the chassis and each other. Therefore, the HiLogger allows you to attach the thermocouple directly to a conductor with a potential to measure it, provided that the voltage to ground does not exceed the maximum rating. If noise is likely affect measurement, wrap heat-resistant tape around the thermocouple for insulation, or use an ungrounded thermocouple and electrically insulate the input line.

Setting the Digital Filter

To remove noise from input signals, the digital filter can be set for the analog channels. Select 50 or 60 Hz to match the local line frequency.

When 50 or 60 Hz is selected, longer recording intervals produce lower cut-off frequencies and better noise suppression.

A larger number of channels (input units) raises the cut-off frequency for a specific recording interval, and weakens noise suppression.

See:"Chapter 11 Specifications": "Cut-off frequency" (p .237)

Inserting a Capacitor in the Signal Line

When noise affects the signal source directly or when measuring high-frequency pulses, it is effective to insert a capacitor between the "+" and "-" input terminals so that the noise does not enter the 8430-20. When inserting a capacitor, use one with a rated voltage that is equal to or exceeds the input voltage.

When a capacitor is inserted between the "+" and "-" input terminals, there are no restrictions on the recording interval because the filter is applied before the channel scan operation.

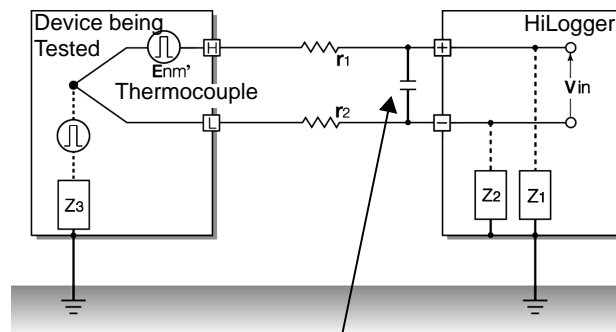

The capacitance of the capacitor should range from several μF to several thousand μF . Insert the capacitor between the "+" and "-" input terminals.

Appendix 9 Frequently Asked Questions

Here are some common questions and answers about the HiLogger.

Installation and Settings

Question	Remedial Action	Reference page
Can the HiLogger be installed at an angle? Can it be mounted on a wall?	Use the optional Hioki Z5000 Fixed Stand.	"Chapter 11 Specifications": "Options (sold separately)" (p .239)
How to measure the temperature of an object having applied voltage?	Be careful to not exceed 300 V DC between channels (for the Universal Unit, or 250V DC for the Voltage/Temp Unit), or 300 V AC/DC to ground. For higher voltage, avoid direct electrical contact, such as by using non-grounding thermocouples.	"4.1 Confirming Measured Values, and Starting Measurement" (p. 83): WARNING
Is current measurement available?	Measure by connecting a 250 Ω resistor between + and - input terminals.	"Connect a 4-20 mA output device and record the average value every minute"(p. A28)
What is the maximum measuring time using the battery pack?	About 5 hours (@23°C)	"2.2 Using the Battery Pack (Option)" (p. 30)
What is the power consumption?	Normal consumption is about 7 VA, and maximum (while charging the battery with maximum LCD brightness) is 24 VA.	"Chapter 11 Specifications": "Power consumption" (p .227)
Can recording resume automatically after a power outage?	Enable Auto Resume. Recording will automatically resume after a power outage. Because data measured before the outage is not retained in internal memory, we recommend enabling auto saving to removable storage.	"Using the Auto-Resume Function (Resume After Power Restoration)" (p .152)
Can power be supplied from the HiLogger to an external sensor?	+12 V is provided at the external control terminals. Maximum supply current is 100 mA. Ground is common with the HiLogger.	"+12 V Output Connection (for external sensors)" (p .42)

A20

Appendix 9 Frequently Asked Questions

Question	Remedial Action	Reference page
How to minimize thermocouple measurement error when moving the HiLogger between places with much different temperatures?	For thermocouple measurements, terminal temperature is measured by an internal sensor to provide reference junction compensation. When the ambient temperature changes abruptly, or when air blows directly on the terminals, errors occur due to thermal imbalance between the terminals and temperature sensor. When the HiLogger is moved to a location with significantly different ambient temperature, allow at least 60 minutes for thermal equalization before measuring.	"Instrument Installation" (p .6)
When connecting a thermocouple directly to the HiLogger, should reference junction compensation be set to external (EXT) or internal (INT)? How is accuracy affected?	Select INT when connecting a thermocouple (or compensating leads) directly to the HiLogger. Overall measurement accuracy is the sum of the accuracies of the thermocouple and the reference junction compensation (RJC). Example: when measuring 0 to 100°C with a K 100°C f.s. thermocouple For ±0.6°C thermocouple accuracy and ±0.5°C RJC accuracy, temperature measurement accuracy is ±1.1°C.	"Temperature Measurement Settings (using thermocouples)" (p .56)
How to display only CH1 to CH3?	Select only the channels to be used on the Input Channel Settings display. To acquire data without displaying it, select x as the waveform display color.	"Input Channel Settings" (p .53) "Selecting Waveform Display Color" (p .65)
I want to measure motor temperature. How can I display the difference between ambient and measured temperature in real time?	Use the waveform calculation function. Calculates and displays the waveform of the real-time sum, difference, product, or quotient of values measured on two channels.	"7.3 Waveform Calculations" (p. 149)
How can I acquire maximum, minimum, and average values every hour?	"Interval Calculation" calculates and displays the latest results after each interval. TXT format data can be saved to removable storage in real time.	"7.1 Calculate Average, Maximum, Minimum, and Etc." (p. 143)
I am measuring humidity with a converter that converts 0 to 100% RH to 1 to 5 V. How can I read humidity directly?	Set the scaling method to [2-pt], and enter the values. (1:1 conversion → 0, 2:5 conversion → 100, units: %RH)	"3.6 Scaling Settings (as needed)" (p. 69)

Triggering		
Question	Remedial Action	Reference page
Why does measurement not start when "Waiting for trigger" is displayed?	Triggering is enabled. To start recording immediately with the START key, disable all trigger criteria or the trigger function on the [Trig & Alm] screen.	"5.3 Confirming All Trigger and Alarm Criteria Settings" (p. 114)
How to acquire data before a trigger?	Enable pre-triggering to acquire data before trigger events.	"Setting Criteria for Pre-Trigger Measuring (Pre-Trig)" (p. 108)
How to acquire data only when an external signal is HIGH?	Apply the external signal to the EXT.TRIG terminal, and set as follows: [Ext trig]-[Start]: ↑ (Rising), [Stop]: ↓ (Falling) Data will now be acquired only when the external signal is HIGH.	"Using External Triggering" (p. 106)
How can I acquire data continuously starting on 1/4/2010, daily from 9:00 to 17:00, for one month?	Set as follows: Measurement Criteria [Interval]-[Cont]: Off, 8 hr 0 min 0 s [Repeat]: On Timer [Start]: On, 10 Year, 4 Mon, 1 Day, 9 Hour 0 Min 0 Sec [Stop]: On, 10 Year, 5 Mon, 1 Day, 9 Hour 0 Min 0 Sec [Interval]: On, 1 Day, 0 Hour 0 Min 0 Sec	"3.2 Configuring Measurement Settings" (p. 50) "5.4 Periodic (Timer) Measurements" (p. 115)
Is it possible to measure on 120 channels using two synchronized HiLoggers?	Measurement start can be synchronized using an external trigger. Sampling cannot be synchronized.	"9.4 Synchronous Measurements with Multiple HiLoggers" (p. 164)

Measuring		
Question	Remedial Action	Reference page
What should I do about zero offset when the input is shorted?	Execute zero adjustment to compensate for offset when the inputs are shorted.	"2.7 Compensating for Input Circuit Offset (Zero Adjustment)" (p. 48)
Even though a signal is only input on CH1, why do similar waveforms appear on unused channels?	An open-circuit input terminal can be affected by signals on other channels. By closing the input terminal circuit, normal measurement is possible. If this is impractical, disable unused measurement channels, or short the + and - terminals together.	
Why does it seem that measurement fluctuations are larger on UNIT2 than on UNIT1?	A larger number of channels (input units) raises the cut-off frequency for a specific recording interval, and weakens noise suppression.	"3.8 Suppressing Noise (Enable Digital Filtering)" (p. 73)

Appendix 9 Frequently Asked Questions

Question	Remedial Action	Reference page
How to display numerical data values?	Press WAVE/DATA repeatedly to cycle through the Waveform (only), Waveform + Numerical Values, and Numerical Values (only) displays. Numerical values can be displayed in a large font on the enlarged numerical display. Numerical values at specific locations can be displayed using A/B cursors.	"Waveform/Numerical Screens" (p .19) "Viewing Input Signals as Numerical Values" (p .87) "Displaying Cursor Values" (p .91)
What happens to pulse integration when there are more than one million pulses?	The counter saturates at 1,073,741,823 counts. If you expect to exceed this count, we recommend measuring with the Integration Mode ([Count]) set to Instantaneous ([Inst]), and summing later with a spreadsheet program.	"Integration (Count) Measurement Settings" (p .62)
What is the timing difference between CH1 and CH2?	When the [Filter] is Off, the time difference between data on neighboring channels is about 500 μ s, regardless of recording interval. When the [Filter] is enabled (50 or 60 Hz), the time difference increases with longer recording intervals.	"Appendix 1 Scan Timing" (p. A1)
How can I apply markers while measuring for easy searching later? How can I search for alarm event locations?	Event marks can be applied by the following methods. <ul style="list-style-type: none"> • Press START while measuring • Press the on-screen [Make Mark] button. • Apply a signal to the EXT.TRIG terminal • When a warning occurs 	"4.3 Marking Waveforms and Searching Marks (Search Function)" (p. 93)
Multiple temperature measurement values are scattered, even at the same location. Is it possible to match the value measured on CH1?	The Offset Cancel function is convenient for this. The value measured on UNIT1, CH1 is used as the scaling (offset) value for other channels.	"3.6 Scaling Settings (as needed)" (p. 69)
Is it possible to signal an alarm on ALM1 when the temperature on CH1 exceeds 40°C, and on ALM2 when it exceeds 50°C?	Yes. Four alarm channels are provided. Multiple alarms can be assigned to the same input channel.	"5.2 Alarm Output" (p. 109)

Data Saving		
Question	Remedial Action	Reference page
Can after-market CF cards be used?	Operation cannot be guaranteed. Please use a Hioki-specified card to avoid problems.	"2.6 Inserting a CF Card or USB Flash Drive (when saving data)" (p. 45)
Can after-market USB flash drives be used?	They can be used, although for real-time saving, we recommend using a Hioki-specified CF card option for data protection. Operation can only be guaranteed for Hioki CF card options. Also, USB flash drive security features such as fingerprint authentication are not supported.	"2.6 Inserting a CF Card or USB Flash Drive (when saving data)" (p. 45)
Can removable media be replaced while measuring?	Yes. Put the cursor on the [EJECT] button at the lower right of the screen, press ENTER , and remove the media following the displayed message.	"Replacing Removable Storage During Real-Time Saving" (p. 127)
How much recording space is available?	It depends on setting conditions (number of channels and recording interval). About 200 days of recording is possible using 30 analog channels at 1 s recording interval to 1 GB media.	"Appendix 7 Maximum Recordable Time" (p. A12)
How can I process acquired data later with a spreadsheet program?	Auto-saved files recorded in [Waveform(realtime)] mode to removable storage can be quickly and conveniently converted to a text (CSV) file with the Utility Logger program, which can then be loaded into a spreadsheet program. Auto-saved files recorded in [CSV(real-time)] mode can be directly loaded into a spreadsheet program, but note that the data cannot be reloaded into the HiLogger.	"Automatic Saving (Waveform Data and Numerical Calculation Results)" (p. 125)
How can I load data from a CF card onto the PC when it has no CF card slot?	Data can be transferred to a PC using the supplied USB cable and the USB Drive mode. Data can also be transferred to a PC using the FTP function and LAN communications.	"6.5 Transferring Data to a PC (USB Drive Mode)" (p. 140) "10.5 Transferring Data to a PC with the FTP Server Function" (p. 193)
How can I create files every hour, from 0:00 (ideal split time)?	Set auto-saving [Split Save] to Periodic [Ref Time] .	"Automatic Saving (Waveform Data and Numerical Calculation Results)" (p. 125)

Appendix 9 Frequently Asked Questions

Question	Remedial Action	Reference page
What is the file limit when auto saving to removable storage?	Depending on file size and CF card capacity, more than 1,000 files can be saved in one folder, although only 1,000 can be displayed on the file screen. As the number of files increases, the time required to start and stop measurement also increases, so we recommend storing no more than 1,000 files, if possible. (When saving, a folder named "HIOKI_LR8400" is created, and files with different data types are saved in subfolders within it.)	"6.1 About Saving and Loading Data" (p. 121)
Is data retained in internal memory when I turn the power off after measuring? I did not use auto saving to removable storage.	If waveforms are displayed when power is turned on, the data has been retained. Data in internal memory is retained for about 30 minutes after power-off. However, if power is off for more than 30 minutes, the data is lost. To avoid such data loss, we recommend preparing and making settings for power outages when measuring for a long time.	"What happens to data in a power outage?" (p .123)
Why is only part of the data saved when saving to removable storage after measuring?	When A/B cursors are set to specify a save time span, only data within that span is saved. Also, internal memory capacity limits saving of measurement data to the most recent eight million data points. If you need to save more data points, enable real-time auto saving beforehand.	"Specifying a Waveform Time Span" (p .90) "Automatic Saving (Waveform Data and Numerical Calculation Results)" (p .125)
After starting measurement with real-time auto saving, can I still acquire data if I neglected to insert removable storage media until later?	As long as storage media is inserted before internal memory overflows, data from the start of measurement will be saved to the removable storage. In the worst case (shortest interval), internal memory overflows after about two minutes.	"Replacing Removable Storage During Real-Time Saving" (p .127)
Why does "Saving" continue to be displayed and saving not finish when saving internal memory data as text after measurement?	To save all data from a full internal memory to removable media as text after measurement takes about one hour. To abort the saving process, press and hold STOP for some time. We recommend saving binary data, and later converting to text with the Logger Utility (which takes only a few seconds).	Logger Utility Instruction manual "7.1.1 Saving Measurement Data as Text"
How to view data saved in binary format on a PC?	The Logger Utility PC application program is included on the supplied CD. Install it on the PC and use it to open the file.	"10.3 Using the Logger Utility" (p. 187)

Appendix 9 Frequently Asked Questions

Question	Remedial Action	Reference page
When opened in Excel, the time displayed is elapsed time from start. How can I display real time?	<p>When saving data in CSV format on the HiLogger, the displayed time is determined by the [Time Disp] setting on the System screen. Select [Date] to display real time.</p> <p>When converting CSV format with the Logger Utility, set the [Time Axis Format] to [Absolute Time].</p>	<p>"Selecting the Horizontal (Time) Axis Display" (p. 155)</p> <p>Logger Utility Instruction manual "7.1.1 Saving Measurement Data as Text"</p>
What are the files with .MEM and .LUW extensions?	<p>MEM is the file extension for HiLogger waveform data, and LUW is the file extension for Logger Utility waveform data. LUW files cannot be loaded into the HiLogger.</p>	<p>"6.1 About Saving and Loading Data" (p. 121)</p> <p>Logger Utility Instruction manual</p>
How are event marks handled when converting data to text (CSV)?	<p>When converting data to text with the HiLogger: Event numbers are included alongside measurement data. This is convenient when you need to later extract only marked data.</p> <p>When converting data to text with the Logger Utility: Event mark information is not included.</p>	<p>"4.3 Marking Waveforms and Searching Marks (Search Function)" (p. 93)</p>

Logger Utility

Question	Remedial Action	Reference page
What kind of program is the Logger Utility?	<p>Running on a PC connected to the HiLogger by LAN or USB cable, it provides real time data acquisition, display, and calculation; display and analysis of waveform (binary) data acquired by the HiLogger; conversion of binary data to text (CSV) data; and printing.</p>	<p>Logger Utility Instruction manual</p>
While measuring with the Logger Utility, can measurement data be transferred to a PC connected only when needed, and the PC disconnected at other times?	<p>This is not possible while measuring with the Logger Utility. However, it can be done by transferring data files from removable storage using the FTP function.</p>	<p>"Automatic Saving (Waveform Data and Numerical Calculation Results)" (p. 125)</p> <p>"10.5 Transferring Data to a PC with the FTP Server Function" (p. 193)</p>
What is the method for converting data to a text (CSV) file with the Logger Utility?	<ol style="list-style-type: none"> 1. In the menu bar, select [File]? [Save File in Text Format]. 2. Select a file for CSV conversion in the displayed dialog, and set [CSV (comma separated)] as the file type. 3. Make other settings as necessary, and click the [Save] button. 	<p>Logger Utility Instruction manual</p>

Appendix

Appendix 10 Introduction to Measurement Applications

Two measurement applications are introduced.

Measuring Electrical Energy by Pulse Count

This method acquires pulses from a watt-hour meter with pulse output of 50,000 pulses/kWh, and measures power consumption over one month (30 days). Watt-hour meter output pulses are measured every 30 minutes, and integrated energy is measured over a month.

1 Prepare the Following Before Measuring

Items to prepare

- HiLogger
 - AC Adapter (supplied)
 - Measurement (input) leads
 - CF Card *
- *: Hioki option

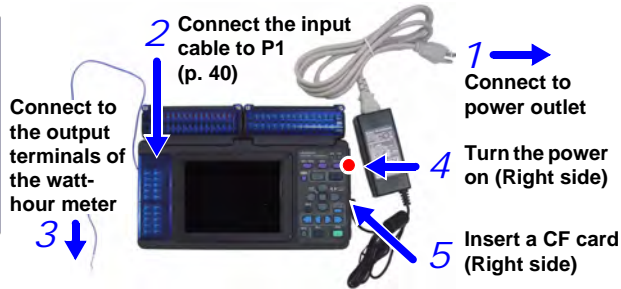

2 Configure Measurement Settings

On the [Setting] screen, set the recording interval and recording time, and enable auto saving.

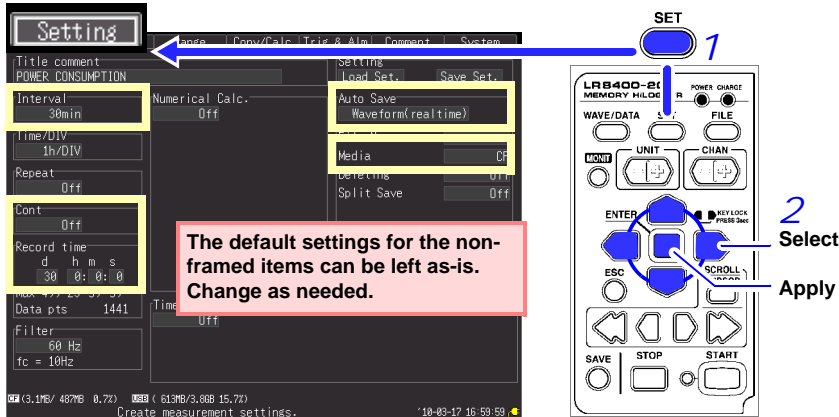

Setting Example

Record at thirty-second intervals for thirty days automatically on the CF card
Interval: 30min, Count: Off, Record time: 30 days
Auto Save: Waveform(realtime), Media: CF

Make input channel settings on the [CH] screen.

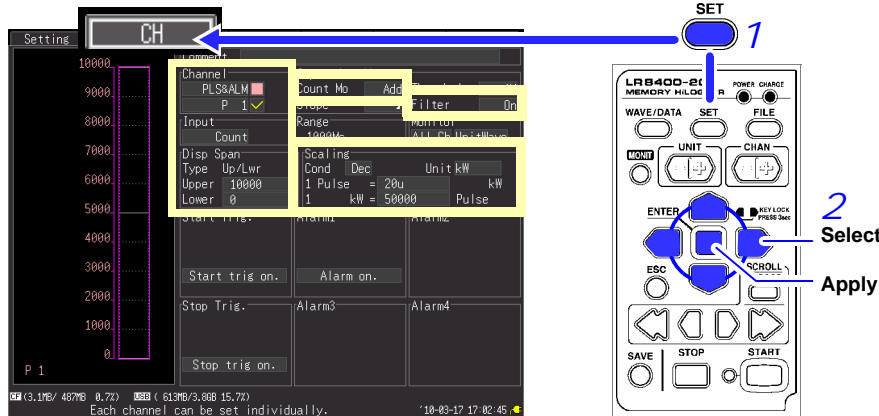

Setting Example
 Unit: PLS&ALM, Channel: P1,
 Input: Count, Count Mo: Add
 Filter: On

Scaling
 Cond: Dec, Unit: kW, 1kW=50,000 Pulse

Disp Span
 Type: Up/Lwr, Upper: 10000, Lower: 0

When set as shown at the left, the vertical axes appear like this.

Measurement Hints

- Enable scaling to read measured values directly as electrical energy [kWh]. The display range changes automatically when scaling is enabled, so set the upper and lower display limits after enabling scaling.
- When the watt-hour meter uses mechanical (relay) contacts for output, chattering effects can be removed by enabling the filter.

3 Start and finish measuring

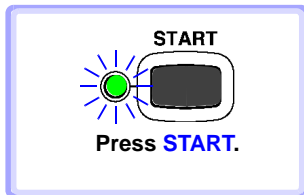

- Data is recorded for the specified recording time and saved to CF card. Recording stops 30 days after starting.
- To stop recording early, press **STOP**.

Connect a 4-20 mA output device and record the average value every minute

This example introduces a method to connect an instrumentation device with 4-20 mA output and measure current variations. The average value is recorded every minute.

1 Prepare the Following Before Measuring

- Items to prepare**
- HiLogger
 - AC Adapter (supplied)
 - Measurement (input) leads
 - 250 Ω Shunt Resistance
 - CF Card*
- *: Hioki option

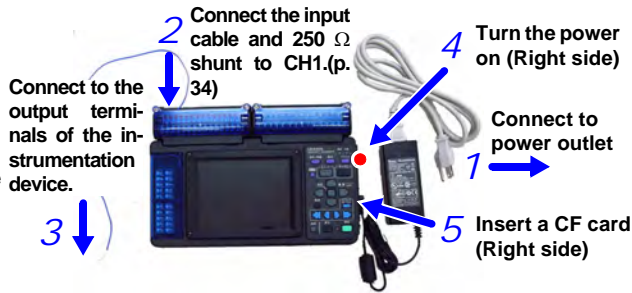

2 Configure Measurement Settings

On the [Setting] screen, set the recording interval and recording time, and enable auto saving and numerical value calculation.

Select 50 or 60 Hz to match the local line frequency.

The default settings for the non-framed items can be left as-is. Change as needed.

Setting Example

To record at every 5-second interval for one hour, with auto saving to CF card, and recording calculated values every minute along with measurement data:

- Interval: 5s, Cont: Off, Record time: 1 hour**
- Numerical Calc.: On, Calc1: Average, Split Calc: On, Length: 1 min**
- Auto Save: Waveform+Calc, Split Save: Off, Media: CF**

Measurement Hints

Filter : When 50 or 60 Hz is selected, longer recording intervals produce lower cut-off frequencies and better noise suppression.

Make input channel settings on the [CH] screen.

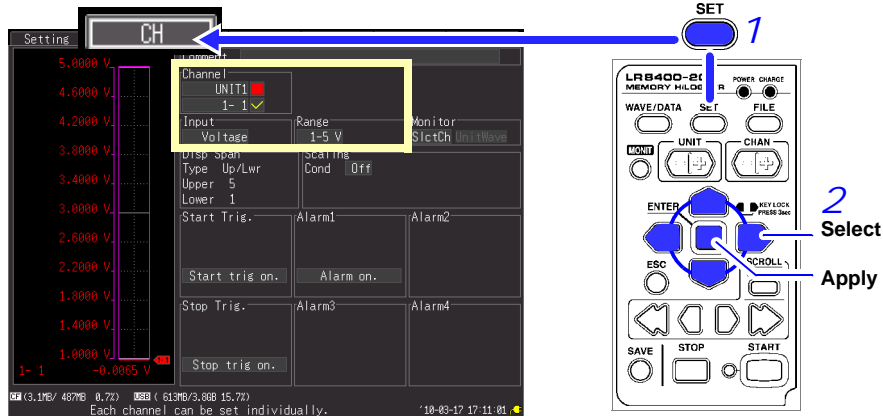

Setting Example
 Unit: UNIT1, Channel: 1-1, Input: Voltage, Range: 1-5V

When set as shown at the left, the vertical axes appear like this.

Measurement Hints
 The "1-5 V" setting automatically selects the 10-V range with a 5-V upper limit and 1-V lower limit. To change the upper and lower limits, select the 10-V range.

3 Start and finish measuring

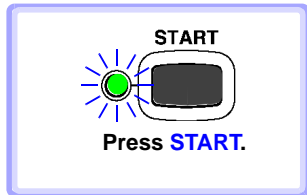

- Data is recorded for the specified recording time with calculations performed every minute, and saved to CF card. Recording stops one hour after starting.
- To stop recording early, press **STOP**.

Appendix 11 Input Circuit Diagram

Diagrams of the input circuits are shown below.

Analog Inputs (Voltage, Thermocouple, Humidity, RTD, and Resistance)

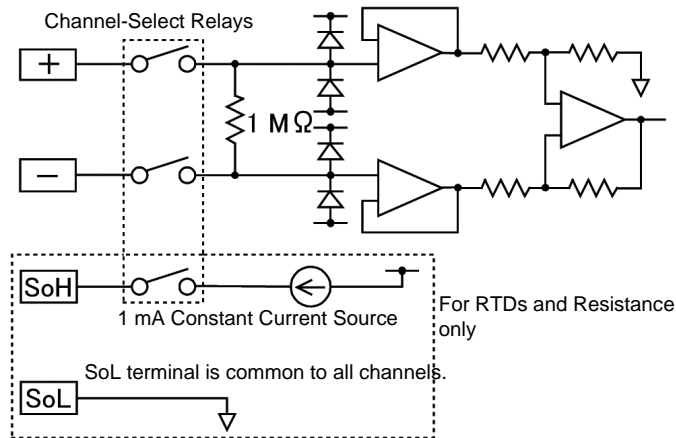

Pulse Input Circuit Diagram

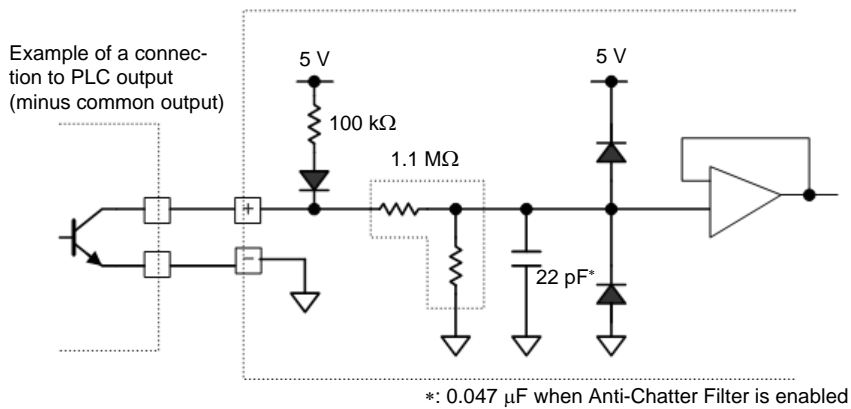

Index

Symbols

+12 V42

Number

0 position66
100BASE-T165
4-20 mA34

A

A/B cursors91
Alarm99, 109
Alarm Event Marking157
Alarm output109, 163
 Upon thermocouple burn-out113
ALM41, 109, 163
AND105
Auto calculation144
Auto Resume152
Auto resume133
Auto save124
Average value143, 148

B

Background Color154
Backlight Brightness154
Backlight Saver153
Batch Proc75, 76, 77, 78, 80
Battery pack30
 Continuous operating time30
Beep Sound154
Beeper154
Binary122
Burn-out detection56, 57

C

Calculation formula150
Calculation Results
 Save124
CF card45, 160
Copy138
Delete136
Load132
Rename137

Sort139
Charging time31
Cleaning243
Clock Setting158
Comment71
Communications commands223
Continuous recording51
Cursor
 Type92
Cursor values91

D

Daisy chain (serial) synchronization164
Decimal Mark156
Decimal Point Character156
Default SettingA 11
Default settingsA 11
Delete while saving126
DHCP179, 182
Display Color154
Display range66
DNS182
Drive135

E

E-Mail216
Error messagesA 2
Event mark93, 97
Event mark for alarm157
EXT.TRIG43, 157, 161
External control terminals161
External Trig In106, 157
External trigger99
External Trigger Input161

F

File namingA 8
File Protection153
File screen47, 135
Formatting47
FTP211
FTP client196
FTP server193
FTP/HTTP Authentication212

Index 2

Index

FTP/HTTP authentication 188, 195

G

Gateway182
Gateway IP182
Gauges86
GND 40, 42, 43

H

Horizontal axis (Time Base)68
Horizontal cursors92
Host Name182
Humidity measurement59

I

Initialize159
Initializing77
Inspection 33, 243
Installing173
Integration (Count) measurement62
Interval Calculation148
IP Address180

J

Jump89

K

Key operation
 Trouble244
KEY/LED160
Key-Lock25

L

LAN178
 Communication features165
 When LAN communication fails186
Language155
LCD160
Level monitor54
Level trigger 100, 102
Load134
Load Set.132
Logger Utility187
Logic measurement61
Logic trigger 100, 104
LR8500 Voltage/Temp Unit28
LR8501 Universal Unit28

M

Maximum value 143, 148
Measurement values 22
Memory 131
Minimum value 143, 148
Monitor 26
Move the cursor(s) 92

N

N-Calc. Data Saving 156
Network 178
Noise73, A 13
Numerical calculations 143
Numerical values 87

O

Operating keys 17
OR 105

P

Peak value 143, 148
Port Number 182
Pre-Trig 108
Pulse measurement 61

Q

Quick Save 128, 129

R

Real-Time Calculation 143
Recording time 51
Ref Time 126
Remote operating 189
Repair 243
Repeat recording 51
Resistance measurement 60
Revolution measurement 63
ROM/RAM 160
RTD 58

S

Save
 Auto save 124
 Calc Results 130
 File type 122
 Numerical calculation results 130

Index 3

Index

Quick save	124
Save Set	131
Screen Image	130
Select & Save	124
Waveform	130
Waveform data	130
Scaling	69
Scrolling	88
Select & Save	128
Self-Test	160
Separator	156
Slope	62, 63
SMTP	216
Specified time span for calculation	147
Split Length	126
Split Save	126
Split-calculation	145
Start Backup	152
Start/Stop Confirmation Messages	155
Start/Stop message	155
Subnet Mask	180, 182
System Reset	159
System screen	151

T

Temperature measurement	
RTD	58
Thermocouple	56
Text	122
Thermocouple	56
Time Disp	155
Time to maximum value	143, 148
Time to minimum value	143, 148
Time Value Display	155
Timer	99, 115
Trace cursors	92
TRIG.OUT	43, 162
Trigger combining logic	105
Trigger input	107
Trigger output	162
Triggering	99
Triggering criteria	105

U

Uninstalling	177
Unit Information	160
USB	166
Communication features	165
USB cable	170
USB Drive Mode	140

USB driver	167
USB flash drive	45
Load	132
USB flash driver	
Copy	138
Delete	136
Rename	137
Sort	139
USB Memory	160

V

Vertical cursors	92
Voltage measurement	55

W

Waveform calculations	143
Waveform display color	65
Waveform/Numerical screen	85
Window trigger	100, 103

Z

Zero Adjust	48
Zoom	66

Warranty Certificate

Model	Serial No.	Warranty period One (1) year from date of purchase (___ / ___)
<p>This product passed a rigorous inspection process at Hioki before being shipped.</p> <p>In the unlikely event that you experience an issue during use, please contact the distributor from which you purchased the product, which will be repaired free of charge subject to the provisions of this Warranty Certificate. This warranty is valid for a period of one (1) year from the date of purchase. If the date of purchase is unknown, the warranty is considered valid for a period of one (1) year from the product's date of manufacture. Please present this Warranty Certificate when contacting the distributor.</p> <p>Accuracy is guaranteed for the duration of the separately indicated guaranteed accuracy period.</p> <ol style="list-style-type: none"> 1. Malfunctions occurring during the warranty period under conditions of normal use in conformity with the Instruction Manual, product labeling (including stamped markings), and other precautionary information will be repaired free of charge, up to the original purchase price. Hioki reserves the right to decline to offer repair, calibration, and other services for reasons that include, but are not limited to, passage of time since the product's manufacture, discontinuation of production of parts, or unforeseen circumstances. 2. Malfunctions that are determined by Hioki to have occurred under one or more of the following conditions are considered to be outside the scope of warranty coverage, even if the event in question occurs during the warranty period: <ol style="list-style-type: none"> a. Damage to objects under measurement or other secondary or tertiary damage caused by use of the product or its measurement results b. Malfunctions caused by improper handling or use of the product in a manner that does not conform with the provisions of the Instruction Manual c. Malfunctions or damage caused by repair, adjustment, or modification of the product by a company, organization, or individual not approved by Hioki d. Consumption of product parts, including as described in the Instruction Manual e. Malfunctions or damage caused by transport, dropping, or other handling of the product after purchase f. Changes in the product's appearance (scratches on its enclosure, etc.) g. Malfunctions or damage caused by fire, wind or flood damage, earthquakes, lightning, power supply anomalies (including voltage, frequency, etc.), war or civil disturbances, radioactive contamination, or other acts of God h. Damage caused by connecting the product to a network i. Failure to present this Warranty Certificate j. Failure to notify Hioki in advance if used in special embedded applications (space equipment, aviation equipment, nuclear power equipment, life-critical medical equipment or vehicle control equipment, etc.) k. Other malfunctions for which Hioki is not deemed to be responsible <p>*Requests</p> <ul style="list-style-type: none"> • Hioki is not able to reissue this Warranty Certificate, so please store it carefully. • Please fill in the model, serial number, and date of purchase on this form. 		

13-09