

User Manual



IRTC550 Pocket Thermal Imager



Content	Page
1.Introduction.....	4
2.Safety Information.....	4
3.Structure Description.....	6
4.Specifications.....	7
5.Before You Start.....	9
5-1.How to Charge the Battery.....	9
5-2.Power ON.....	9
5-3.Power OFF.....	10
5-4.Desktop.....	10
5-5.LED light.....	12
5-6.Temperature Measurement.....	12
5-7.Emissivity Adjustment.....	13
5-8.Reflected Temperature.....	14
5-9.Thermal Imager Reporter Software.....	14
6.Menu.....	15
6-1.Main Menu.....	15
6-2.Image Mode.....	16
6-3.Image Palette.....	18
6-4.Image Adjustment.....	20
6-5.Measurement Menu.....	21
6-6.Parameter Menu.....	22
6-7.Settings Menu.....	25
6-8.Camera Menu.....	32
6-9.Video Menu.....	34
6-10.Files Browser.....	35
6-11.USB Mode.....	35
7.Android/iOS APP Thermview Pro.....	36
7-1.Software Install and Uninstall.....	36
7-2.Thermview Pro Function.....	36
8.PC Software.....	40
8-1.System Required	40
8-2.Thermview Pro Install.....	40
8-3.Running.....	41
8-4.Uninstall.....	41
9.Fault Diagnosis and Exclusion.....	42

1. Introduction

- The Thermal Imager is handheld imaging camera used for predictive maintenance, equipment troubleshooting and verification.
- Focus the lens to the object, then the thermal and visual images are displayed on the LCD and can be saved to a Micro SD Memory card.
- Transferring images to a PC is accomplished by removing the SD memory card and connecting it to a PC through the included card reader, or transfer the images and video stream to the smart device with “**Triplett InfraRead**” app installed.
- In addition to the features mentioned above, the Thermal Imager provide video recording with audio and play back.

2. Safety Information

- Do not disassemble or do a modification to the Thermal Imager.
- Do not point the Thermal Imager (with or without the lens cover) at intensive energy sources, for example devices that emit laser radiation or the sun, this can have an unwanted effect on the accuracy of the camera, it can also cause damage to the detector in the Thermal Imager.
- Do not use the Thermal Imager in a temperature higher than 50°C (122°F), lower than -20°C (-4°F), High temperature or low temperature can cause damage to the Thermal Imager.
- Only use the correct equipment to discharge the battery, if you do not use the correct equipment, you can decrease the performance or the life cycle of the battery, if you do not use the correct equipment, an incorrect flow of current to the battery can occur, this can cause the battery to become hot, or cause an explosion and injury to persons.
- Do not pull out the battery when the thermal imager is working, if you pull out the battery when the thermal imager is working, it may cause the thermal imager work unnormal.
- Do not disassemble or do a modification to the battery, the battery contains safety and protection devices which, if they become damaged, can cause the battery to become hot, or cause an explosion or an ignition.
- If there is a leak from the battery and the fluid gets into your eyes, do not rub your eyes, flush well with water and immediately get medical care.
- Do not make holes in the battery with objects; Do not hit the battery with a hammer; Do not step on the battery, or apply strong impacts or shocks to it; Do not put the battery in or near a fire, or in direct sunlight, or other high-temperature locations; Do not solder directly onto the battery.

- Always charge the battery in the special temperature rang, the temperature range through which you can charge the battery is 0 to 50°C (32 to 122°F), if you charge the battery at temperatures out of this range, it can cause the battery to become hot or to break, it can also decrease the performance or the life cycle of the battery.
- Do not get water or salt water on the battery, or permit the battery to get wet.
- Clean the case with a damp cloth and a weak soap solution, do not use abrasives, isopropyl alcohol, or solvents to clean the case or lens/screen.
- Be careful when you clean the infrared lens, do not clean the infrared lens too vigorously, this can damage the anti-reflective coating.
- Avoid condensation: Take the Thermal Imager from cold to hot, it will appear condensation in thermal Imager, to protect the Thermal Imager, you should power of the Thermal Imager, wait until the Thermal Imager has become war enough for the condensation to evaporate.
- Storage: If you do not use the Thermal Imager, put the Thermal Imager in cool and dry environment, if you store Thermal Imager equipped with the battery, the power of the battery will be exhausted.

3. Structure Description

- 1-LCD Display and Touch Screen
- 2-Power/Calibrate Button
- 3-Photo/Video Capture Button
- 4-Micro SD Card Slot
- 5-Type C USB/Charge
- 6-LED Light
- 7-Visual Camera
- 8-Infrared Camera Lens
- 9-Lanyard Hole
- 10-Hole for Tripod Insertion

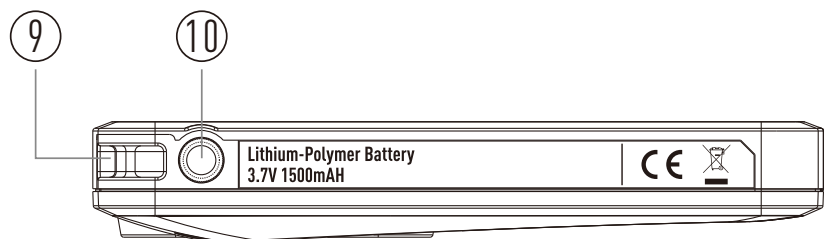
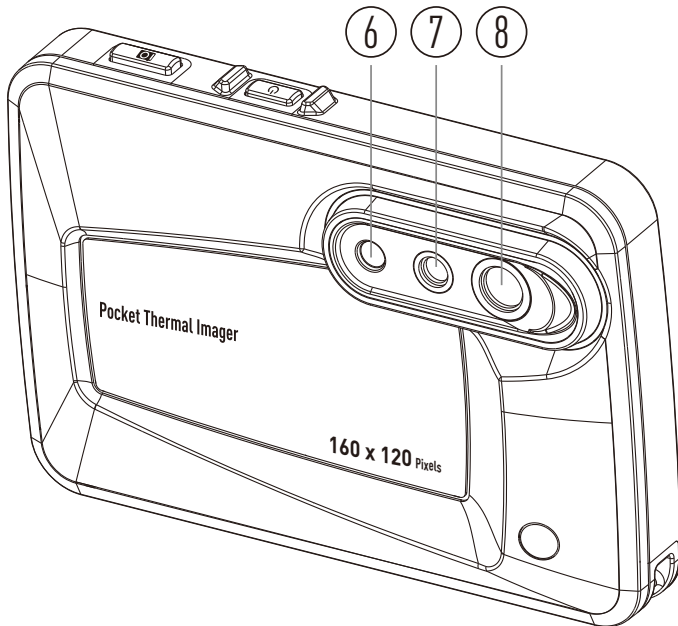
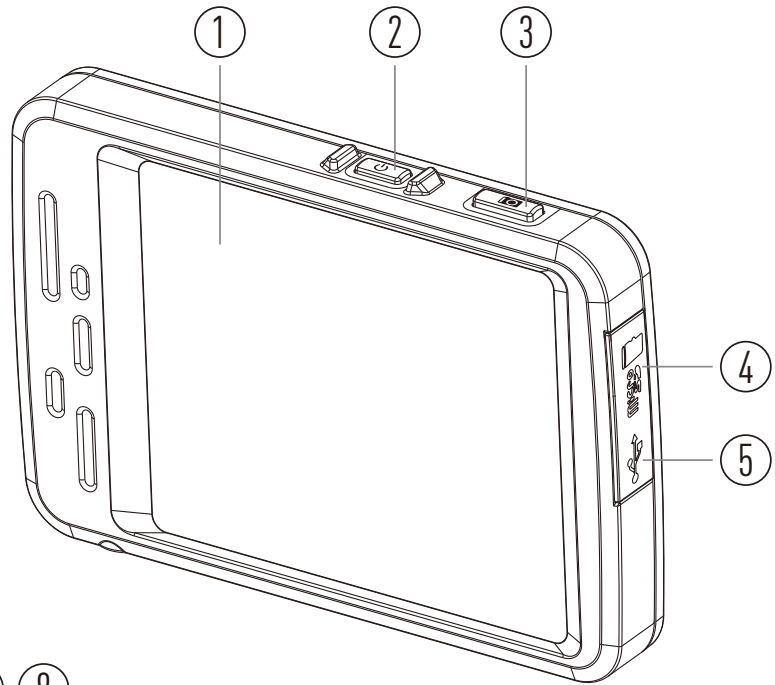

4. Specifications

Imaging and Optical Data

Field of View (FOV)/Minimum Focus Distance	42°x32°/0.5m
Thermal Sensitivity/NETD	<0.04°C at 30°C (86°F)/40mK
Image Frequency	9 Hz
Focus Mode	Focus free
Zoom	1-32x continuous, digital zoom
Focal Plane Array (FPA)/Spectral Range	Uncooled microbolometer/8-14µm
IR Resolution	160x120 Pixels

Image Presentation

Display	3.5 in. LCD, 640x480 Pixels, Touch screen
Image Modes	IR image, Visual image, Picture in picture, Auto fusion
Color Palette	IRON, Rainbow, Grey, Grey Inverted, Brown, Blue-red, Hot-cold, Feather, Above alarm, Below alarm, Zone alarm, Vision zone

Measurement

Object Temperature Range	-20 to 150°C (-4 to 302°F) 0 to 550°C (32 to 1022°F)
Accuracy	±2°C (3.6°F) or ±2% of reading (Environment temperature 10-35°C; Object temperature >0°C)

Measurement Analysis

Spot	Center Spot, Three Manual Spots
Automatic Hot /Cold Detection	Auto hot or cold markers
Area	Three areas analyse
Line	Two line analyse
Measurement Corrections	Emissivity, Reflected temperature, Ambient temperature, Atmospheric humidity, Infrared compensation, Distance compensation.

Storage of Videos

Storage Media	8Gbytes Micro SD card and 3.4GB internal EMMC
Video Storage Format	Standard MPEG-4 encode, 640x480 at 30fps, on memory card >60 minutes
Video Storage Mode	IR/visual images; simultaneous storage of IR and visual images

Storage of Images

Image Storage Format

Standard JPEG or HIR files including measurement data, on memory card >6000 pictures

Image Storage Mode

IR/visual images; simultaneous storage of IR and visual images

Image Analyse

Internal image analyse tools, Complete function.

Set-Up

Set-Up Commands

Local adaptation of units, language, date and time formats, information of camera

Languages

Multinational

Digital Camera

Built-in Digital Camera

2 Megapixels

Built-in Digital Lens Data

FOV 59°

Data Communication Interfaces

Interfaces

USB-TypeC

USB

Data transform between camera and PC

Live video between camera and PC

Wifi

802.11, transfer images and **real-time** video stream

Power System

Battery

Li-ion battery, 4 hours operating time

Input Voltage

DC 5V

Charging System

In camera

Power Management

Automatic shutdown

Environmental Data

Operating Temperature Range

-15 to 50°C (5 to 122°F)

Storage Temperature Range

-40 to 70°C (-40 to 158°F)

Humidity (Operating and Storage)

10%~90%

Drop Test

2m

Bump

25g (IEC60068-2-29)

Vibration

2g (IEC60068-2-6)

Physical Data

Camera Weight, Incl. Battery







<500g

Camera Size (LxWxH)

133x87x24mm

5. Before You Start

5-1. How to Charge the Battery

- Before you use the Thermal Imager for the first time, charge the battery for three and three-half hours.
- The battery status shows on the six-segment charge indicator.
- To charge the battery, use follow before:
 1. Connect the ac power adapter into an ac wall outlet and connect the dc output to the Thermal Imager's ac power socket, the charge light is on, the battery indicator becomes "  →  →  →  →  →  ", while the battery charges with the ac power adapter.
 2. Charge until the charge indicator becomes "  ", the charge icon not changed .
 3. Disconnect ac power adapter when the battery is full charged.

Note: Make sure that the Thermal Imager is near room temperature before you connect it to the charger. Do not charge in hot or cold areas. When you charge in extreme temperature, battery capacity may be decreased.

5-2. Power ON

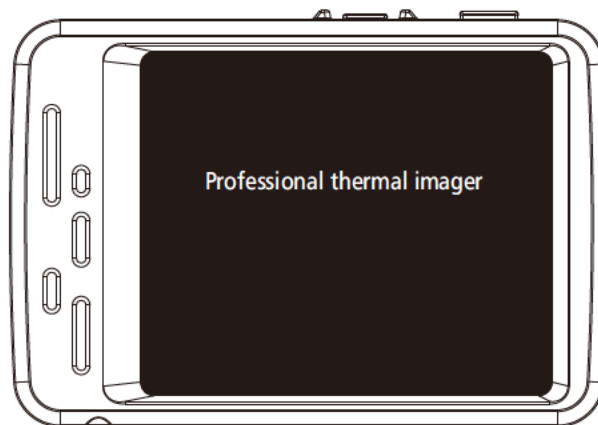

To turn the Thermal Imager on, push the **Power**  Button.

Note: After power on the device, The thermal Imager needs sufficient warm-up time for the most accurate temperature measurements and best image quality. So the visible image will first appear, and the thermal sensor will calibrate internal for several seconds. After that the thermal image will be displayed on the screen.

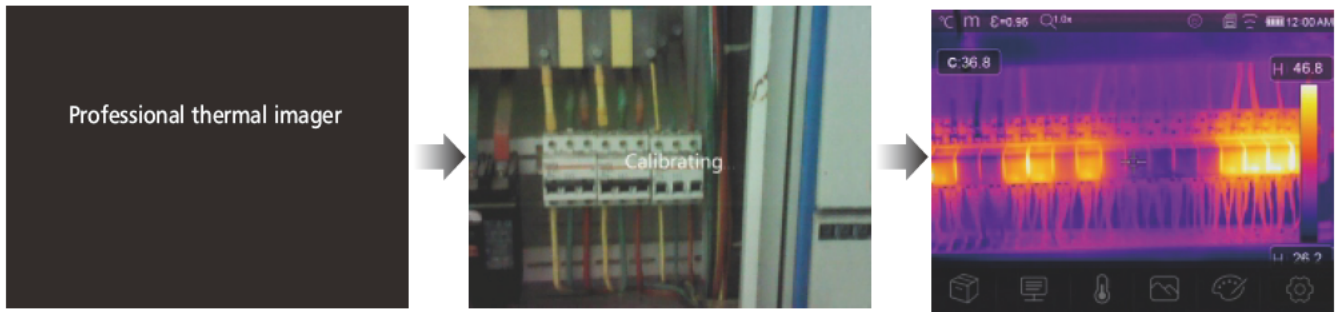



5-3. Power OFF

- When Thermal Imagers power on, push and hold the **Power**  Button for two seconds, then popup the power off menu, press “OK” to power off the device.
- Push and hold the **Power**  Button for twelve seconds, the device will be forced power off directly.



5-4. Desktop

- | | |
|----------------------------|---|
| 1-Temperature unit | 11-Centre point temperature readings |
| 2-Distance unit | 12-Video record status Image display area |
| 3-Emissivity | 13-AGC mode |
| 4-Zoom Quick menu entrance | 14-Max temperature of current scene |
| 5-Flashlight ON status | 15-Image display area |
| 6-SD card | 16-Manual adjust Max temperature of current scene |
| 7-Wifi on status | 17-Manual adjust Min temperature of current scene |
| 8-Battery capacity status | 18-AGC mode select button |
| 9-Time | 19-Min temperature of current scene |
| 10-Main menu | 20-Color bar |

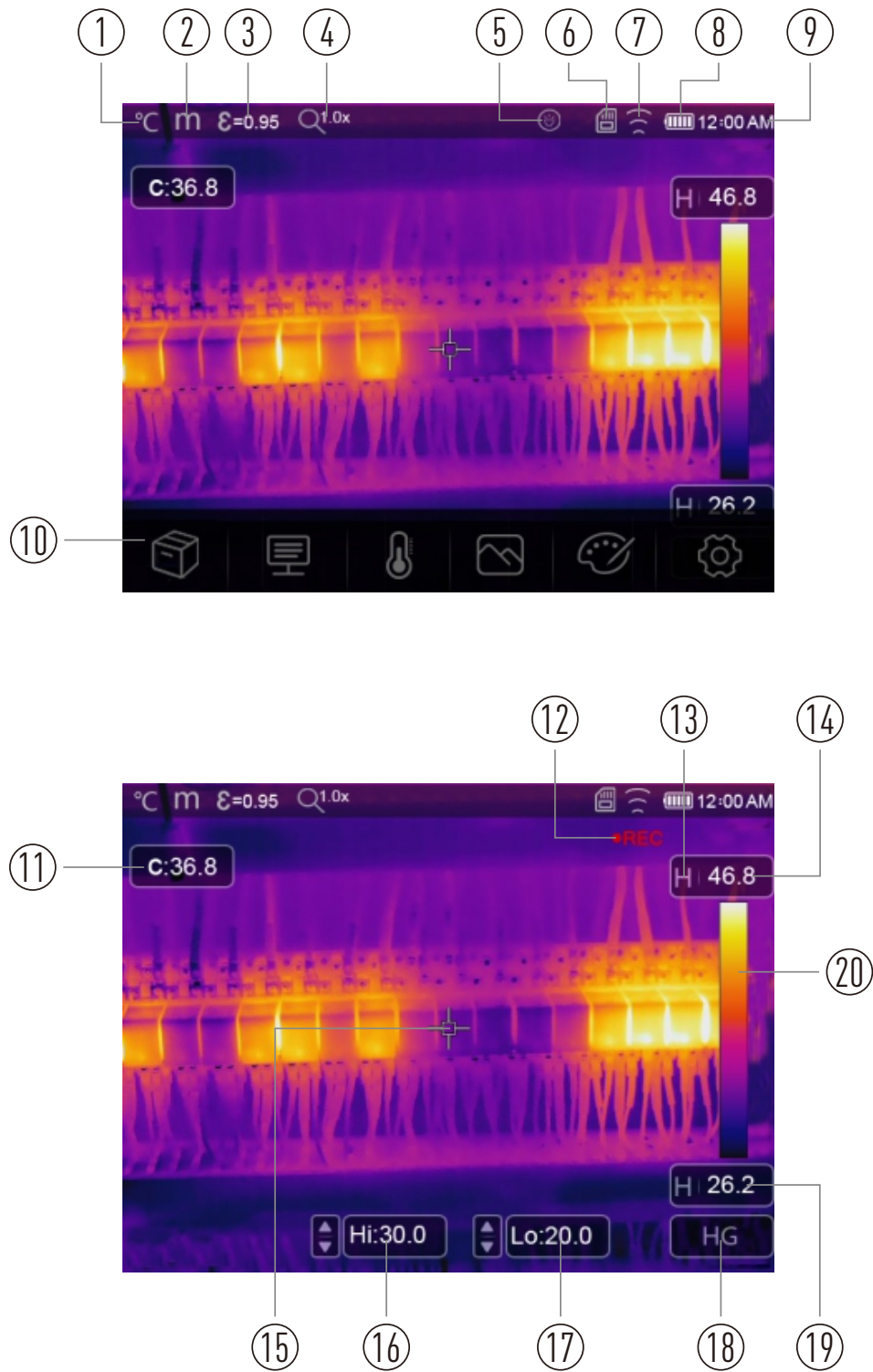

5-5.LED light

In device setting menu, press the flash light button, the LED light will be on or off.

5-6.Temperature Measurement

- All objects radiate infrared energy, the quantity of energy radiated is base on the actual surface temperature and the surface emissivity of the object, the Thermal Imager senses the infrared energy from the surface of the object and uses this data to calculate an estimated temperature value.
- Many common objects and materials such as painted metal, wood, water, skin, and cloth are very good at radiating energy and it is easy to get relatively accurate measurements.
- For surfaces that are good at radiating energy (high emissivity), the emissivity factor is ≥ 0.90 , this simplification does not work on shiny surfaces or unpainted metals as they have an emissivity of < 0.6 , these materials are not good at radiating energy and are classified as low emissivity.
- To more accurately measure materials with a low emissivity, an emissivity correction is necessary.
- Adjustment to the emissivity setting will usually allow the Thermal Imager to calculate a more accurate estimate of the actual temperature.
- More information please see “**Emissivity Adjustment**” to get the most accurate temperature measurements.

5-7.Emissivity Adjustment

- The correct emissivity value is important to make the most accurate temperature measurement, Emissivity of a surface can have a large effect on the apparent temperatures that the Thermal Imager observes, understanding the emissivity of the surface, but may not always, allow you to obtain more accurate temperature measurements.

Note: Surfaces with an emissivity of <0.60 make reliable and consistent determination of actual temperature problematic. The lower the emissivity, the more potential error is associated with the Imager's temperature measurement calculations. This is also true even when adjustments to the emissivity and reflected background adjustments are performed properly.

- Emissivity is set directly as a value or from a list of emissivity values for some common materials, the global emissivity displays in LCD Screen as $E=x.xx$.
- The following table gives typical emissivity of important materials.

Material	Emissivity
Water	0.96
Stainless Steel	0.14
Aluminum Plate	0.09
Asphalt	0.96
Concrete	0.97
Cast Iron	0.81
Rubber	0.95
Wood	0.85
Brick	0.75
Tape	0.96
Brass Plate	0.06
Human Skin	0.98
Pvc Plastic	0.93
Polycarbonate	0.80
Oxidized Copper	0.78
Rust	0.80
Paint	0.90
Soil	0.93

5-8. Reflected Temperature

- Using the offset factor, the reflection is calculated out due to the low emissivity and the accuracy of the temperature measurement with infrared instruments is improved.
- In most cases, the reflected temperature is identical to the ambient air temperature, only when objects with strong emissions with much higher temperature are in the proximity of the object being measured should be determined and used.
- The reflected temperature has only little effect on objects with high emissivity.
- The reflected temperature can be set individually, follow these steps to get the right value for the reflected temperature.
 1. Set the emissivity to 1.0.
 2. Adjust the optical lens to near focus.
 3. Looking in the opposite direction away from the object, take a measurement and freeze the image.
 4. Determine the average value of the image and use that value for your input of reflected temperature.

5-9. Thermal Imager Reporter Software

- Thermal Imager Reporter software is supplied with the Thermal Imager.
- This Software is intended for Thermal Imager and contains feature to analyze images, organize data and information, and make professional reports.
- Thermal Imager Reporter software allows audio annotations and commentary to be reviewed on a PC.

6.Menu

The menus, together with buttons, are access for Image, Measurement, Emiss, Palette, Temperature measurement range, take photo and video, review, and settings.

6-1.Main Menu

- Touch the screen, the main menu will be popped up, Main Menu is the main interface of the Thermal Imager's menus.
- It contains six items such as Measure parameters, Measure tools, Image mode, Palette, System Settings.



1-**Image Browser:** Enter into the image view.

2-**Paramters:** Parameters set for the calculation temperature.

3-**Measure Tools:** Set for the calculation and display of radiometric temperature measurement data related to the thermal images.

4-**Image Mode:** Set image source for the display on the Thermal Imager's LCD, it contains five items such as infrared image, visual image and fusion.

5-**Palette:** Set the type of color bar.

6-**Settings:** Set for the user preferences such as Language, Unit of temperature measurement, Date, Time, Restore factory setting and Display product information.

6-2. Image Mode

- In Main Menu, press “Image Mode” icon button, highlight “Image Mode”, popup Image submenu which contains five image modes.
- Thermal Imager has 5 kinds of image modes for display: IR, Camera, Fusion, AUF mode, Zoom mode.



 **IR:** Displays only infrared image.



 **Camera:** Displays only visible image.

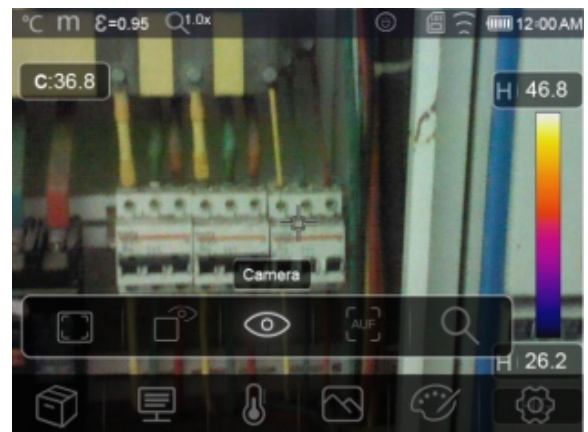

 **Fusion:** Display fusion image of infrared and visible images.



 **AUF:** Auto Fusion mode, compare the centre area temperature with full screen, the machine will calculate the mix ratio of infrared and visible images automatically.



 **Zoom Mode:** Set the image zoom in or zoom out.

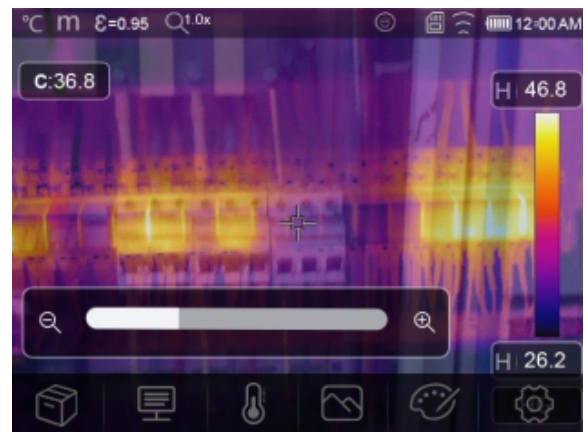
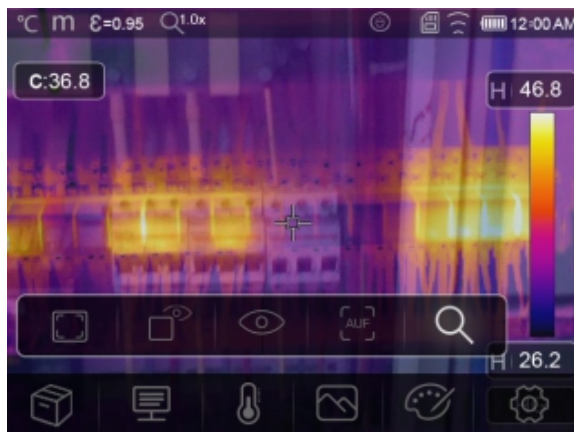

6-3. Image Palette

- The Image Palette lets you change the false-color presentation of the infrared images on display or captured.
- A variety of palettes are available for specific applications.
- The standard palettes offer an equal, linear presentation of colors that allow for best presentation of detail.

Standard Palette

- In main menu, press “**Palette**” icon button, highlight “**Palette**”.
- Popup Image submenu which contains 8 kinds of color palettes and 4 kinds of special palettes.



	Iron
	Rainbow
	Grey
	Grey Invert

	Brown Hot
	Blue Red
	Hot Cold
	Feather

High Alarm: The temperature higher than the high alarm set value will be colored to red, Press the Hi: 30.0 value button to adjust the above temperature.

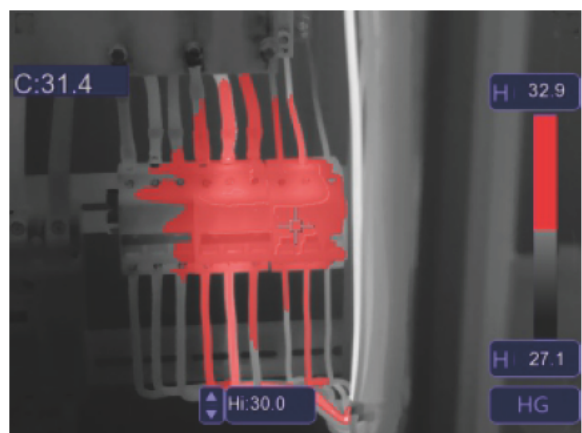

 * **Low Alarm:** The temperature lower than the low alarm set value will be colored to blue, Press the Lo: 29.4 value button to adjust the below temperature.

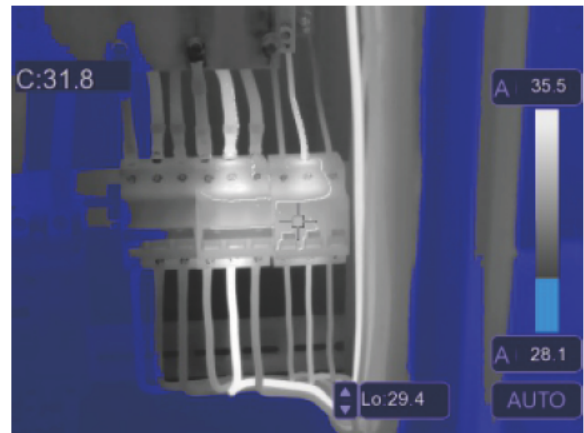

 **Zone Alarm:** The temperature between the high alarm and the low alarm set value will be colored to orange.



 **Visible Zone:** The temperature between the high alarm and the low alarm set value will be colored to the palette, other part of the image will displayed as visible image.

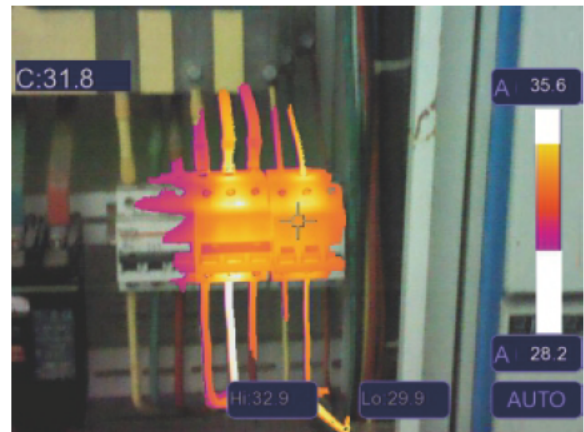

6-4. Image Adjustment

There are three kinds of mode for image adjustment: Histogram, Auto and Manual.

6-4-1. Lock Operation

- Touch the **AGC Mode** Button to switch to Manual mode, lock the current scene temperature range.
- “🔒” means Manual, touch the lock temperature value button to adjust the lock value.

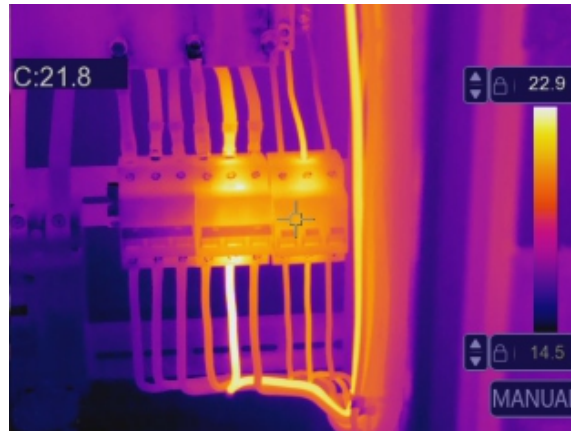

6-4-2. Histogram Mode and Auto Mode

- **Auto Mode:** level and span are decided by the thermal image of minimum temperature and maximum temperature, the relationship between temperature and color is linear.
- **Histogram Mode:** the thermal image is enhanced by histogram algorithm, the relationship between temperature and color is not linear, some part of the image is enhanced.
- Touch the icon **HG** or **AUTO** below the color bar to change the



6-5.Measurement Menu

- In main menu, press “**Measurement**” icon button, highlight “**Measurement**”.
- Popup Image submenu which contains 5 kinds of Measurement tools.



- ✚ **Center Spot:** Measure the center point temperature.
- ⊕ **Manual Spot:** Measure the manual point temperature, there are three manual analyse points.
- ∩ **Line Analyse:** Measure the line temperature, there are two analyse lines, one for horizontal, the other is vertical line.
- ▨ **Area Analyse:** Measure the area temperature, there are three analyse areas.
- 🌡️ **Hi/Lo Spot Analyse:** capture max/minimum temperature.
- 🗑️ **Delete all Analyse:** Delete all analyse tools.

6-6.Parameter Menu

In main menu, touch “Parameters” button, highlight “Emiss” to adjust emiss value.



6-6-1.Ambient Temperature Compensation

Ambient temperature will affect the measurement of the thermal imager, it can be composite from 0 degree to 50 degree.



6-6-2.Reflective Temperature

- The reflective temperature is important for radiometric temperature measurement, thermal Imager has temperature compensation for reflective temperature.
- To get more accurate temperature measurement, accurately set the reflective temperature.
- In most cases, the reflected temperature is identical to the ambient temperature, only when objects with strong emissions with much higher temperature are in the proximity of the object being measured, the reflected temperature must set.



6-6-3.Atmospheric Humidity

- Water droplets in the air can absorb infrared rays, the wet air can affect the measurement of the temperature's accurate.
- The compensation humidity can be set from 10%~100%.



6-6-4.Delta Temperature Compensation

In delta temperature, the value of the delta temperature will affect the measurement directly.



6-6-5.Distance

- There are many substances in the air that can absorb infrared rays, so the infrared ray of the object will **decrease** as the distance increase.
- The distance can be **set** from 2meter to 1000meters.



6-6-6.Emissivity

“Emiss” sets object emissivity, the value range is 0.01~1.00.



6-7.Settings Menu

- 1.In main menu, touch “**Settings**” icon button, highlight “**Settings**”.
- 2.The Settings menu will display.

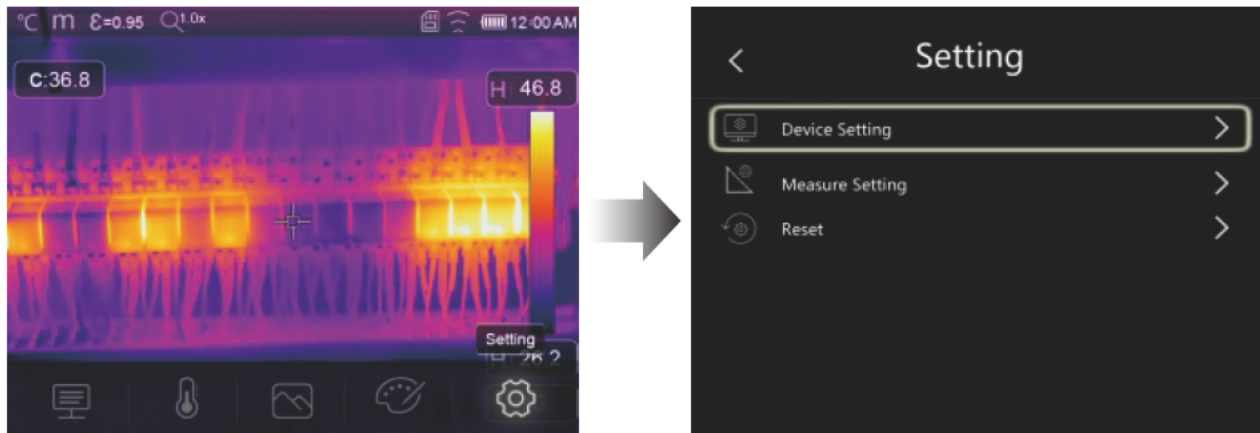

6-7-1.Device setting

There are multipages in Device setting, use \vee icon to go to next page, or use \wedge to go to previous page.

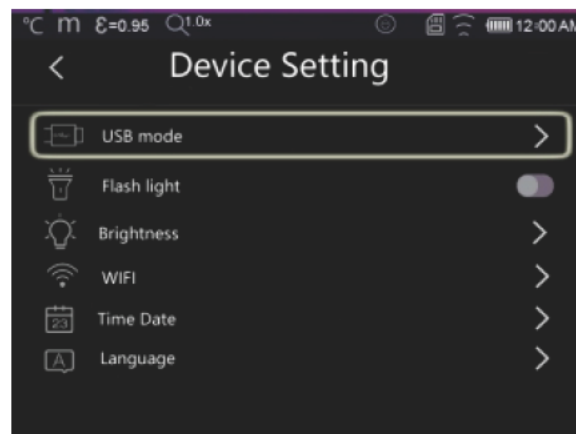

USB Mode:



- **PC Connection:** Set the device as Mass storage mode, if connect the device to the PC with USB cable, there will be a Mass storage device on the PC.
- **PC Camera:** Set the device as UVC camera mode, if connect the device to the PC with USB cable, there will be a UVC camera device on the PC.

Flashlight: Press “ --- ” \rightarrow “ --- ” to turn on the flash light.

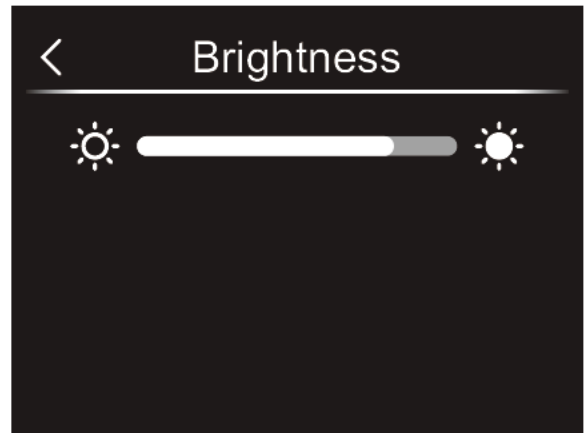
Brightness: Drag the slider bar to adjust the LCD brightness.



WIFI:

- Press “” → “” to turn on the wifi, the wifi model worked on access mode, so it is need to set the SSID and Password to allow other device connect to it.
- The default SSID is “**T-50F**”, the default password is “**12345678**”.

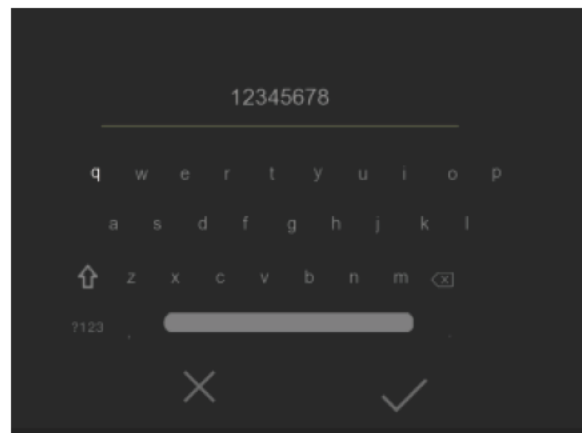
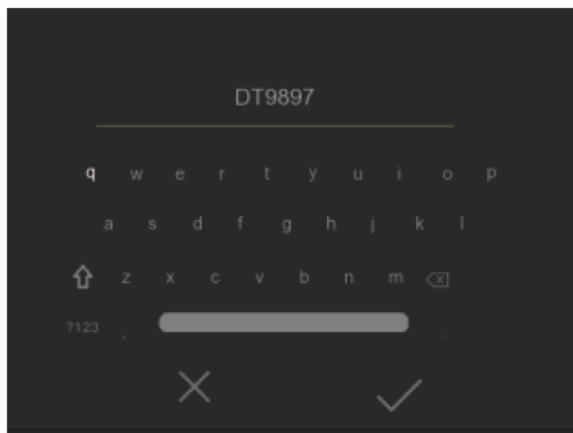
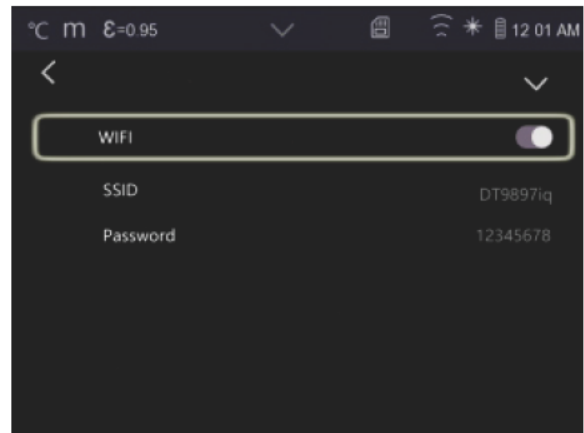

Time Date: Press \wedge or \vee to change time/date, then press “**Set Date**” to save the change, or press “**Cancel**” to quit.

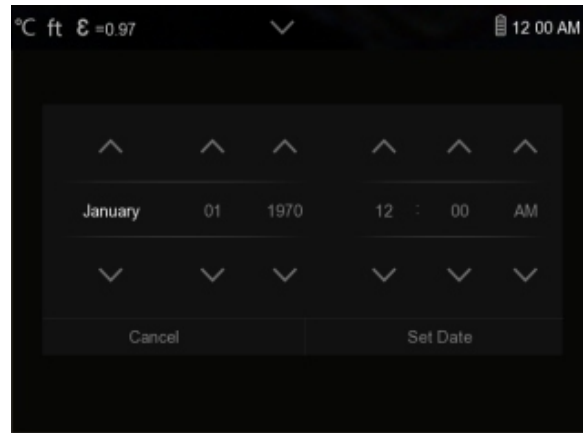

Language: Press the language you want.

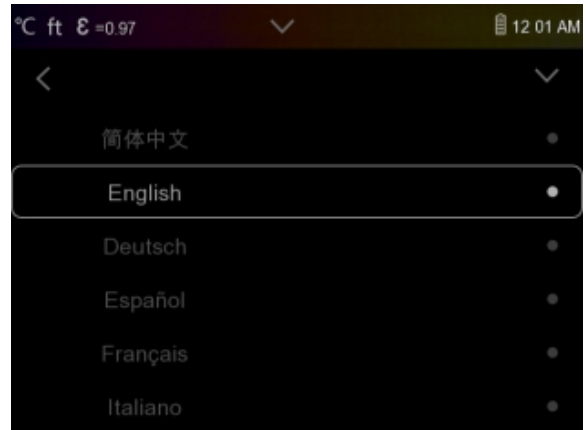

Auto Power Off:

- There are four options in auto power off menu, as follows: “OFF”, “5Min”, “10Min”, “15Min”, “30Min”.
- When press the touch screen or keyboard, the timer of Auto Power Off will be cleared and re-timed.

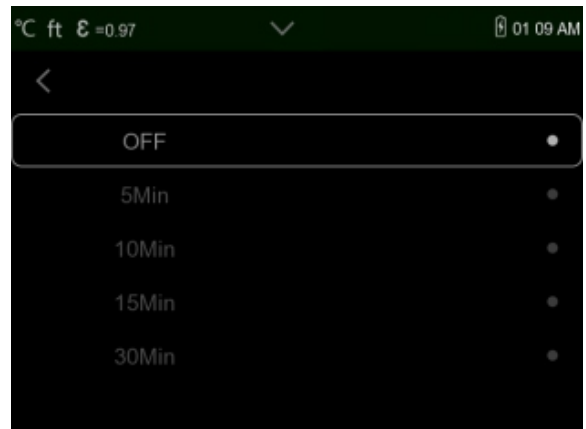

Info: The info menu contains all of the product information, such as: software version, serial number and so on.

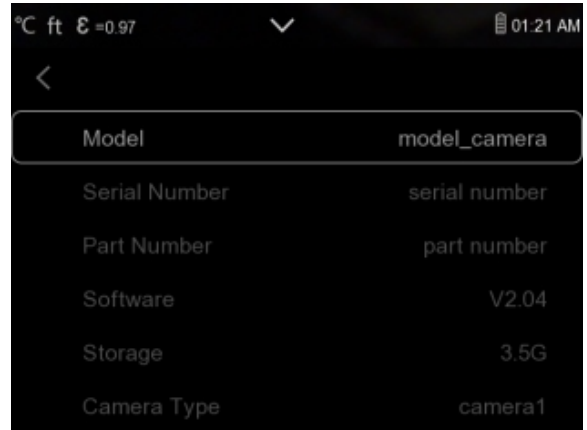

6-7-2.Measure Setting

There are four options in Measure setting menu, as follow picture.



Distance Unit:

- Change the distance unit between “m” and “ft”, “m” means meter, ft means Foot.
- $1(\text{ft})=0.3048(\text{m})$; $1(\text{m})=3.2808399(\text{ft})$

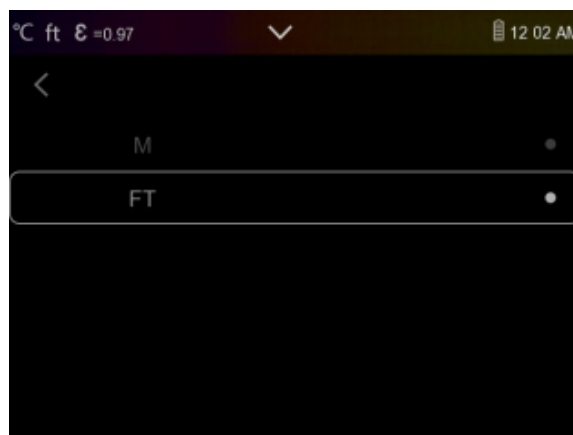

Temperature Unit:

- Temperature Unit have three types to choose: °C, °F and K.
- Conversion relationship: °F=1.8x°C+32, K=273.15+°C.

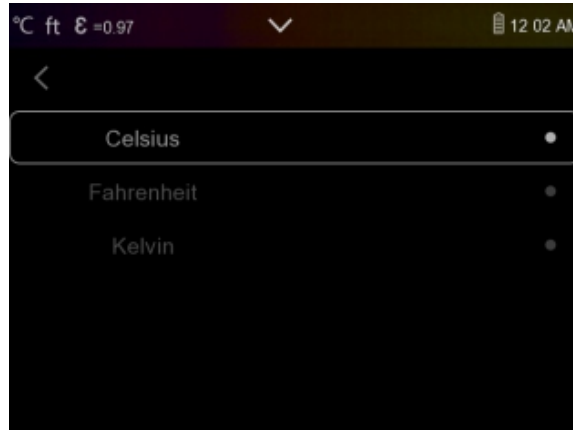

Temperature Range:

- The temperature measurement ranges have “-20~150°C” and “0~550°C” to choose.
- The overlap temperature of the two ranges is more accurate to choose “-20~150°C”.

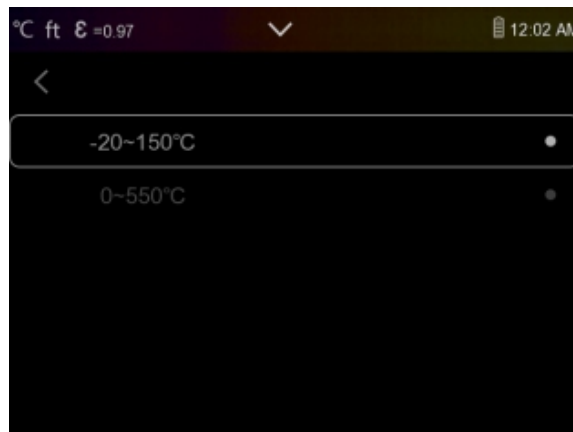

Emissivity:

Quick set the emissivity from the table below:

Material	Emissivity	Material	Emissivity
Water	0.96	Tape	0.96
Stainless Steel	0.14	Brass Plate	0.06
Aluminum Plate	0.09	Human Skin	0.98
Asphalt	0.96	PVC Plastic	0.93
Concrete	0.97	Polycarbonate	0.80
Cast Iron	0.81	Oxidized Copper	0.78
Rubber	0.95	Rust	0.80
Wood	0.85	Paint	0.90
Brick	0.75	Soil	0.93

Image Align:

- Press < ^ > to adjust the vision's position to align the vision and infrared.
- Press X to cancel the setting, press ✓ to save the alignment setting.

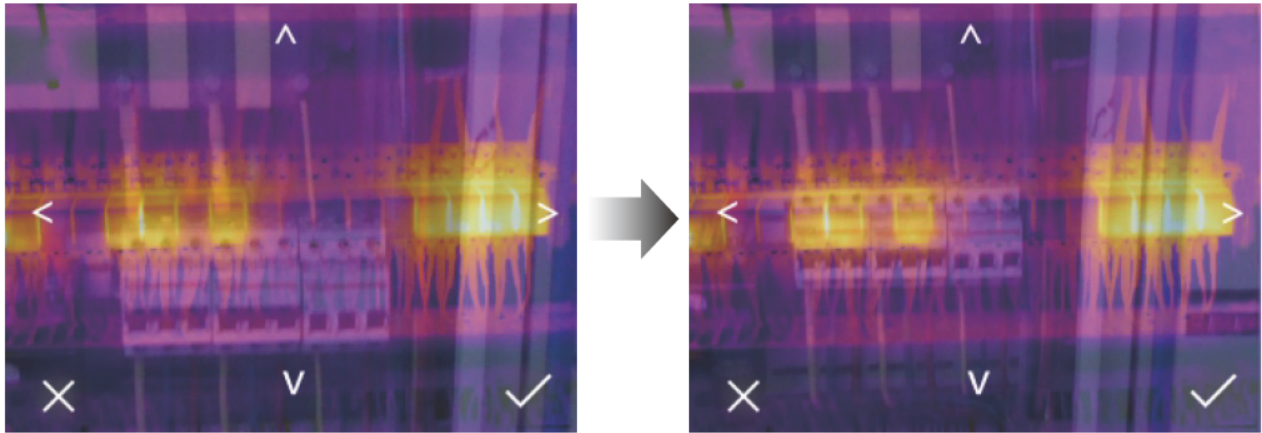

6-7-3.Reset

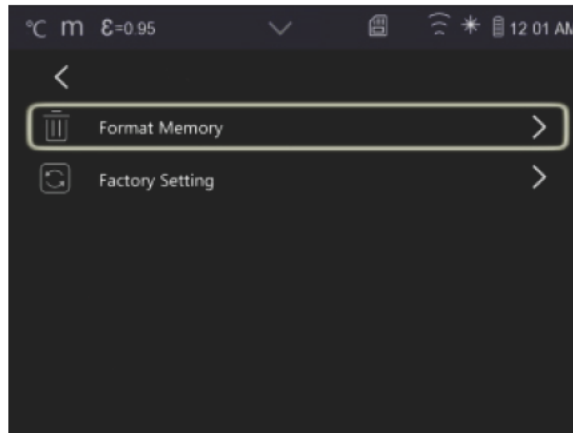

Format Memory: Format Memory operation will format all the Picture Gallery, the device setting is not affected.

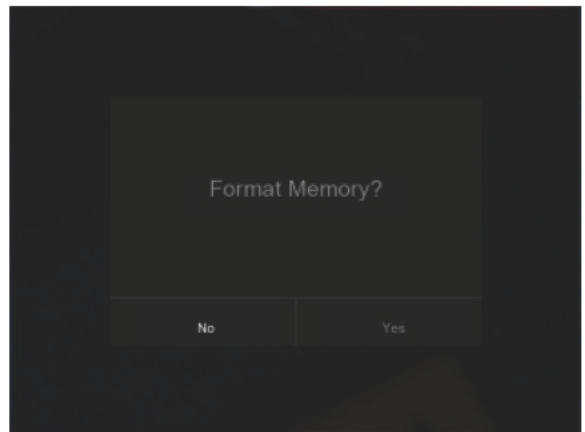

Factory Settings:

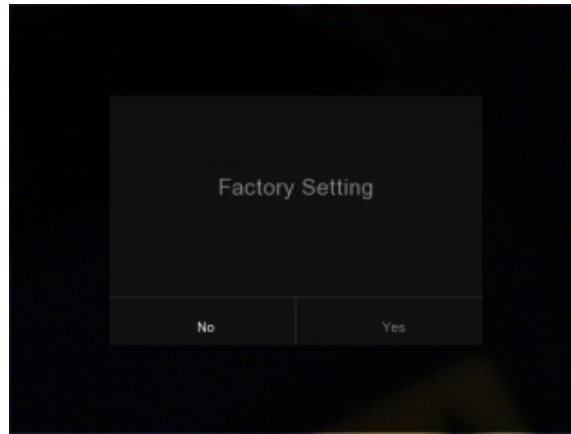

Factory Settings of the Thermal Imager is as follow:

Item	Parameter	Value
Measurement	Center Spot Measurement	OFF
	Hot Spot Measurement	OFF
	Cold Spot Measurement	OFF
Measurement Parameters	Emissivity	0.95
	Reflective temperature	25°C
Image	Mode	Infrared
	Palette	Iron
	Adjustment	Auto
System Setting	Language	English
	HDMI Output	OFF
	Lamp	OFF

6-8.Camera Menu

- Thermal Imager has photo and video functions.
- In photo function, the Imager can save thousands of images, every image resolution is 1280x960, format is “.jpg”, and stores infrared data and visible data in an image.
- In video function, the Imager has mp4 video capture for hours, and save infrared data in “.mp4” format.

Note: Images and video files are stored in SD Memory Card. Images can easily be read and second analyzed within Thermal Imager PC software.

6-8-1.Save Image

- 1.In desktop, press **Photo** button, freeze an image, the save menu will display.
- 2.Touch ✓ button save image, and the image will flash for a second, after the image is saved, the image will be unfreezed.

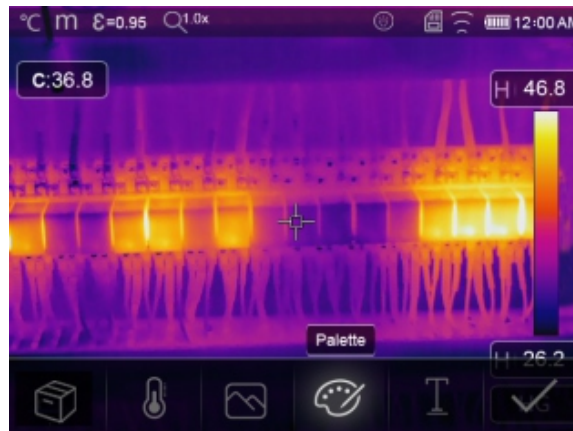

6-8-2.Add Text Note

- Touch the “**Text Information**” icon, it can add some text information into the picture.
- Next time if the saved picture opened in gallery or PC software, the text info will displayed with the picture.



6-8-3.Change Measure Parameters

Touch the “**Parameters**” icon, it can change the image’s measure parameters: Emissivity, Ambient temperature, Humidity, Reflect temperature, Infrared compensation, Distance.



6-8-4.Add Analyse Tools

Touch the “**Measurement**” icon, it can add or change the analysis tools in the image: Point analyse, Area analyse, Line analyse.



6-8-5.Change Image Mode

Touch the “**Image Mode**” icon, it can change the image mode: Thermal, Visible, Picture in picture, Auto fusion, Zoom.



6-8-6.Change Color

Touch the “**Pallete**” icon, it can change the image color.



6-9.Video Menu

The Thermal Imager has .mp4 video capture.

- 1.In desktop, press the **Photo** Button and hold for about 2 seconds, start video capture with voice.
- 2.To stop video capture, press the **Photo** Button again.
- 3.The video saved in the video file.

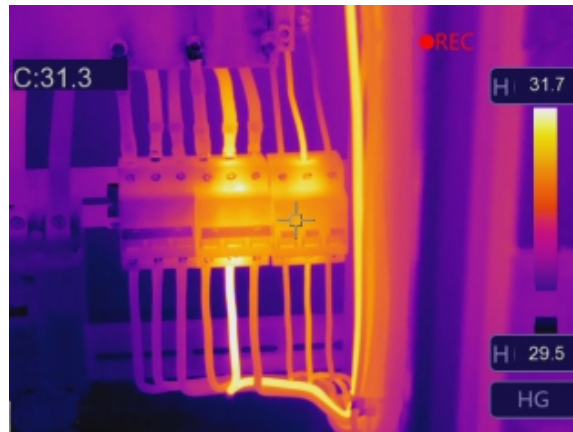

6-10.Files Browser

In desktop, touch  button, popup files Browser, which displays images and videos saved in SD Memory Card.

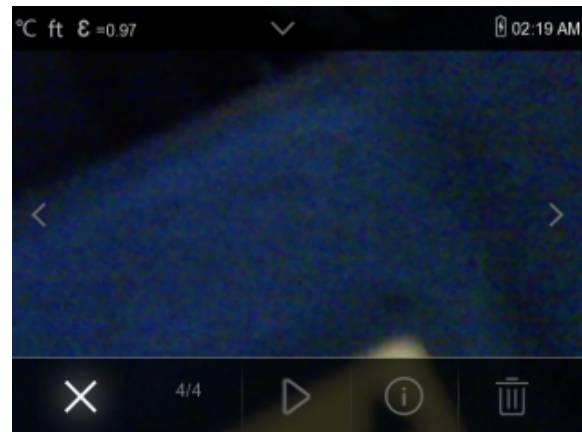
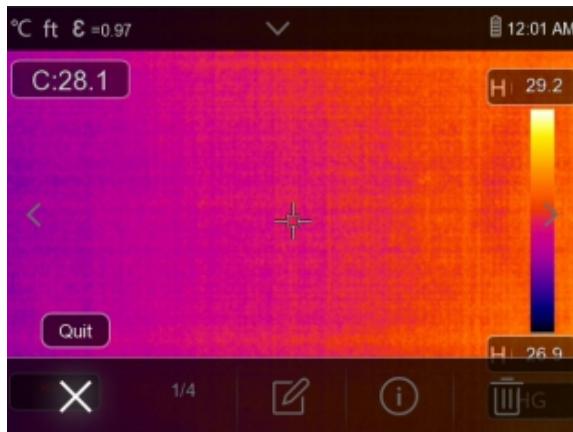

Analyse an Image

When current file type is image, press “” to enter image analysis mode.

Play a Video

When current file type is video, press “” to play video.

Delete a File

press “” to delete the current file.

6-11.USB Mode

- **PC Connection:** Set the device as Mass storage mode, if connect the device to the PC with USB cable, there will be a Mass storage device on the PC.
- **PC Camera:** Set the device as UVC camera mode, if connect the device to the PC with USB cable, there will be a UVC camera device on the PC.

7.Android/iOS APP InfraRead

7-1.Software Install and Uninstall

7-1-1.System Required

Android mobile phone: Android 4.0 above, with USB OTG Support

iOS: iPhone4 above



7-1-2.InfraRead App Install

Android: Search “**InfraRead**” on Google Play and install it.

iOS: Search “**InfraRead**” on Apple Store and install it.

7-2.InfraRead Function

7-2-1.Import Pictures

- 1.Use WiFi connect to IR meter.
- 2.Show IR picture in the phone.

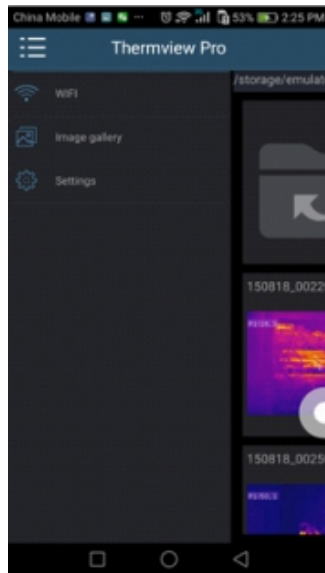

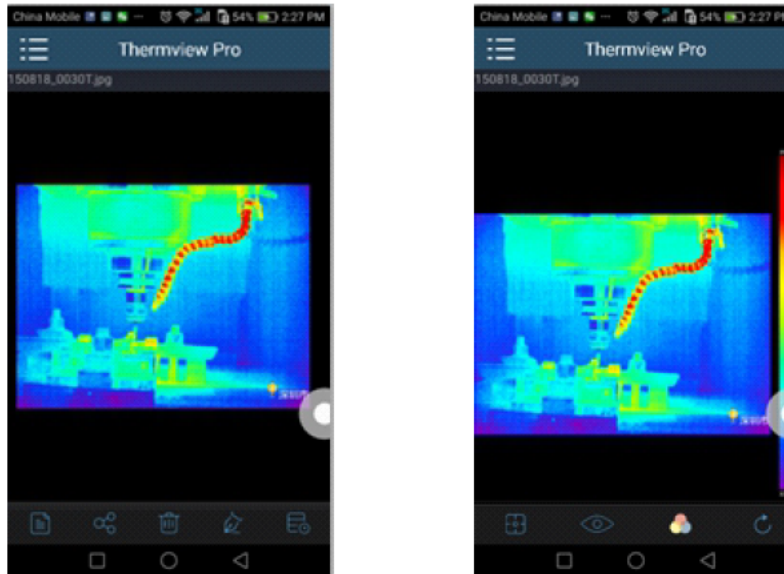

7-2-2.Analyse

Select a IR Picture and click “” icon to analyse it.



1. Image Mode

Click “” icon to select image mode, there are four mode for you to select.

(1)  IR Mode: Only infrared picture displayed.

(2)  Visible Mode: Only visible picture displayed.

(3)  Fusion Mode: The infrared picture is fusioned with visible picture.

2. Colorbar Select



Click “” icon to select colorbar, there are eight colorbar for you choice.



3. Analyse

Click “” icon to analyze the IR pictures, there are three analysis tools:



- (1)  Point Analyze: Add a point to the picture, it will display the temperature of the point.
- (2)  Area Analyze: Add a rectangle to the picture, it will display the highest, lowest and average temperature of the rectangle.

4. Save and Exit

Click “” to save and return to the main page of the APP.

7-2-3. Report and Share

1. Report: Click “” icon to report as a “.pdf” file.



2.Share: Click “” icon to share the Infrared picture with Email, Cloud or Message and so on.

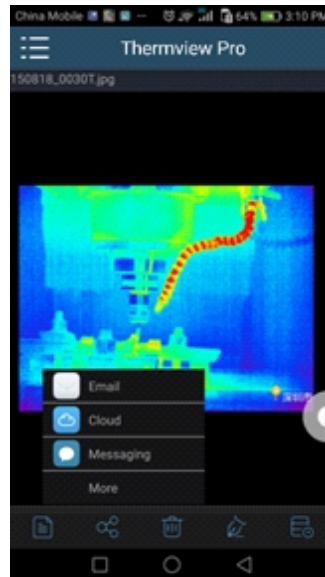

8.PC Software

8-1.System Required

- Window 10 or higher version of Windows system.
- Please make sure you have installed Net Framework 4.6 when you install Thermview Pro software.
- If not, please find and install our Microsoft .NET Framework v4.6.exe that provided to you .
- Ppen the net framework 4.6, Follow all tips to install Net Framework 4.6 till it finishes.
- If your system already have installed Net Framework 4.6, then no need to install again.

8-2 InfraRead Install

- You can insert your installation CD to install directly if you have one, or you can run “setup.exe” to install it as follow.
- Click “Next” to install, till finish installation.

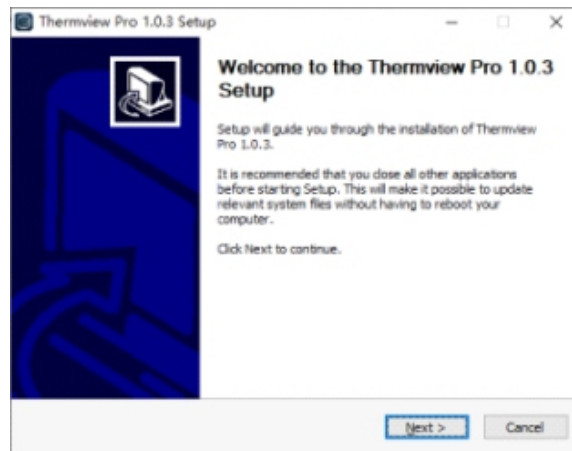

- Installation Successful after click “Finish” like above.

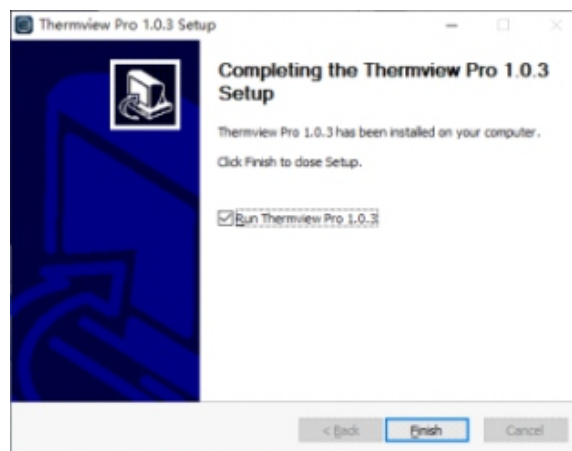

8-3. Running

After ensuring **InfraRead** software has been installed, click shortcuts on the desktop to run the software.

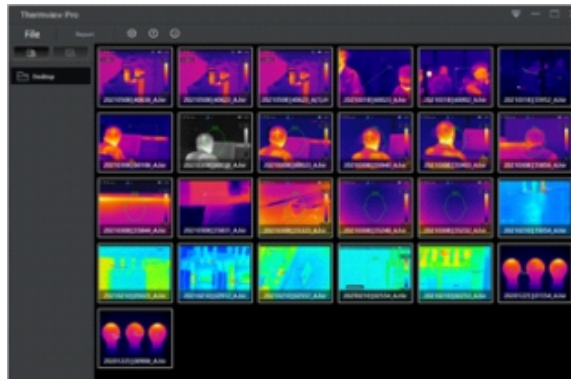

8-4. Uninstall

- Uninstall Thermview Pro in the Installation directory as follow.
- Run "uninst.exe" and then click "YES" to start to uninstall, and finally choose whether to reboot the computer.

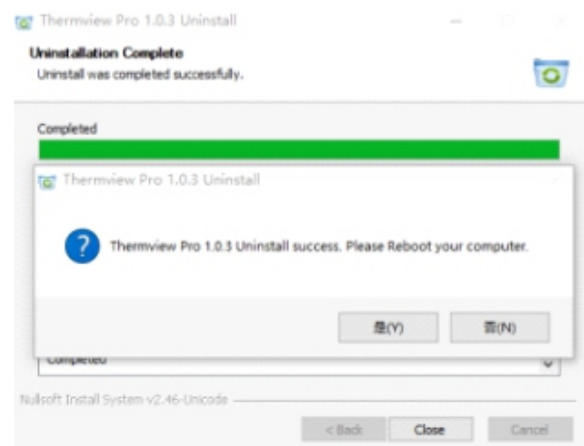
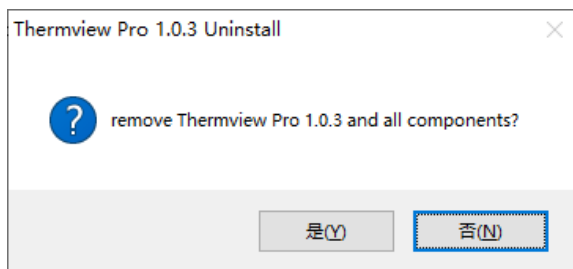

9. Fault Diagnosis and Exclusion

- If you encounter any problems while using the thermal imager, overhaul according to the following table.
- If the problem persists, disconnect the power and contact with the company's technical support department.

Phenomenon of the fault	Cause of the fault	Solution
Thermal imager cannot start	No battery	Inserting the battery
	No power	Replace the battery or charge it
Thermal imager shut down	No power	Replace the battery or charge it
No Thermal image	The lens cap cover	Opened the lens cap

WARRANTY STATEMENT

Triplett Test Equipment offers a one-year warranty to the original purchaser of its products. We guarantee that our products will be free from defects in workmanship and materials for three (3) years from the purchase date.

This warranty does not cover:

- Products purchased from unauthorized distributors.
- Items that have been repaired or altered by unauthorized individuals.
- Damage from misuse, abuse, misapplication, negligence, or accidents.
- Products with altered, defaced, or removed serial numbers.
- Accessories, including batteries.

Copyright © 2025

