

**CM4371
CM4372
CM4373
CM4374**

AC/DC CLAMP METER

HIOKI

Instruction Manual



EN

Aug. 2017 Revised edition 3
CM4371A961-03 17-08H



HIOKI

Contents

Introduction	1
Options (sold separately)	3
Safety Notes	4
Usage Notes	8
Part Names	11
Insert/Replace Batteries	12
Inspection Before Measurement.....	14
Current Measurement	15
Manual Hold / Auto Hold.....	16
Switching ranges	19
Filter Function	20
MAX/MIN/AVG/PEAK.....	21
Simultaneous display of DC current/voltage peak values	22
Backlight / Auto Power Save (APS)	24
Rush current (INRUSH).....	25

CM4371A961-03

i

Contents

Other Measurement Functions	26
Voltage	26
Continuity Check	27
Resistance	27
Diode	27
Capacitance.....	28
Temperature	28
Electric Charge Detection	29
Simultaneous display of DC current and DC voltage.....	29
DC power	29
Bluetooth® Communications (only for CM4372, CM4374)	30
Power-on Option Table	35
Repairs, Inspections, and Cleaning	37
Specifications.....	40
Accuracy Table.....	46

Introduction

Thank you for purchasing the Hioki CM4371, CM4372, CM4373, CM4374 AC/DC Clamp Meter. To obtain maximum performance from the instrument, please read this manual first, and keep it handy for future reference.

This instrument is a clamp meter that can perform true RMS measurement of current simply by clamping it around a circuit. In addition to current, it provides voltage measurement, frequency measurement, rush current measurement, resistance measurement, diode measurement, capacitance measurement, temperature measurement, voltage detection, and DC power measurement.

The CM4372 and CM4374 also provide Bluetooth communications functionality, allowing measurement data to be monitored and logged from a smartphone or tablet.

Introduction

Package contents

AC/DC Clamp Meter

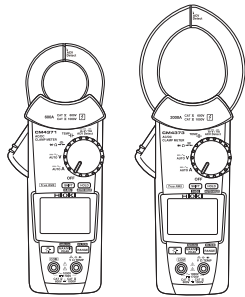

L9207-10 Test lead



C0203 Carrying Case



LR03 Alkaline battery × 2



Instruction Manual*



Precautions Concerning Use of Equipment That Emits Radio Waves (only for CM4372, CM4374)



* Instruction manuals may also be available in other languages.

Trademark

- Bluetooth® is a registered trademark of Bluetooth SIG, Inc.(USA). The trademark is used by HIOKI E.E. CORPORATION under license.
- Android and Google Play are registered trademarks of Google, Inc.
- IOS is a registered trademark of Cisco in the U.S. and other countries.
- iPhone, iPad, iPad mini, iPad Pro, and iPod Touch are trademarks of Apple Inc.
- The App Store is a service mark of Apple Inc.

2

Options (sold separately)

Options (sold separately)

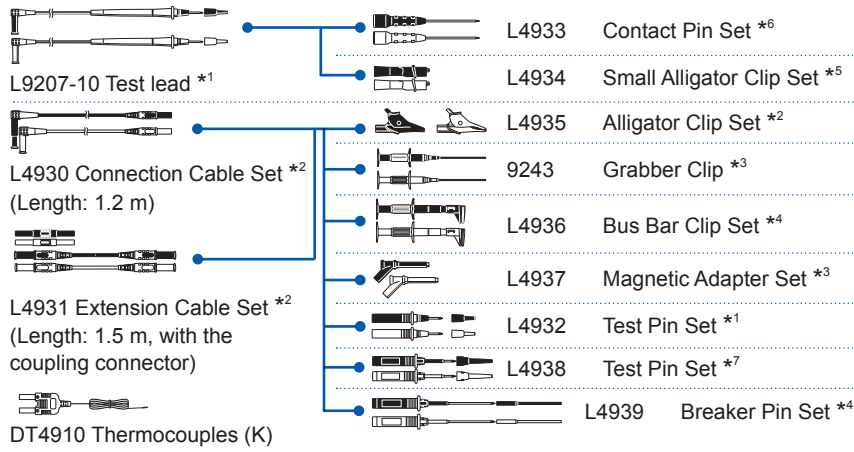

*¹: CAT IV 600 V/ CAT III 1000 V/ CAT II 1000 V
 *²: CAT IV 600 V/ CAT III 1000 V
 *³: CAT III 1000 V

*⁴: CAT III 600 V
 *⁵: CAT III 300 V/ CAT II 600 V
 *⁶: 33 V AC/ 70 V DC
 *⁷: CAT III 600 V/ CAT II 600 V

Safety Notes

Safety Notes

This instrument is designed to conform to IEC 61010 Safety Standards, and has been thoroughly tested for safety prior to shipment. However, using the instrument in a way not described in this manual may negate the provided safety features. Before using the instrument, be certain to carefully read the following safety notes.

DANGER



Mishandling during use could result in injury or death, as well as damage to the instrument. Be certain that you understand the instructions and precautions in the manual before use.

WARNING



With regard to the electricity supply, there are risks of electric shock, heat generation, fire, and arc flash due to short circuits. If persons unfamiliar with electricity measuring instruments are to use the instrument, another person familiar with such instruments must supervise operations.

 **WARNING**





Protective gear



This instrument is measured on a live line. To prevent electric shock, use insulated protective wear such as rubber gloves and rubber boots designed for electrical work as well as a safety helmet as required by occupational health and safety regulations.











Notation

In this document, the risk seriousness and the hazard levels are classified as follows.

 DANGER	Indicates an imminently hazardous situation that will result in death or serious injury to the operator.	IMPORTANT	Indicates information related to the operation of the instrument or maintenance tasks with which the operators must be fully familiar.
 WARNING	Indicates a potentially hazardous situation that may result in death or serious injury to the operator.		Indicates prohibited actions.
 CAUTION	Indicates a potentially hazardous situation that may result in minor or moderate injury to the operator or damage to the instrument or malfunction.		Indicates the action which must be performed.

Safety Notes

Symbols affixed to the instrument

 <p>Indicates cautions and hazards. When the symbol is printed on the instrument, refer to a corresponding topic in the Instruction Manual.</p>	 <p>Indicates DC (Direct Current) or AC (Alternating Current).</p>
 <p>Indicates that dangerous voltage may be present at this terminal.</p>	 <p>Indicates DC (Direct Current).</p>
 <p>Indicates that the instrument may be connected to or disconnected from a live conductor.</p>	 <p>Indicates a grounding terminal.</p>
 <p>Indicates a instrument that has been protected throughout by double insulation or reinforced insulation.</p>	 <p>Indicates the Waste Electrical and Electronic Equipment Directive (WEEE Directive) in EU member states.</p>
 <p>Indicates that the product incorporates Bluetooth® wireless technology.</p>	 <p>Indicates that the product conforms to regulations set out by the EU Directive.</p>

Measurement categories

This instrument conforms to the safety requirements for CAT III 1000 V, CAT IV 600 V measuring instruments.

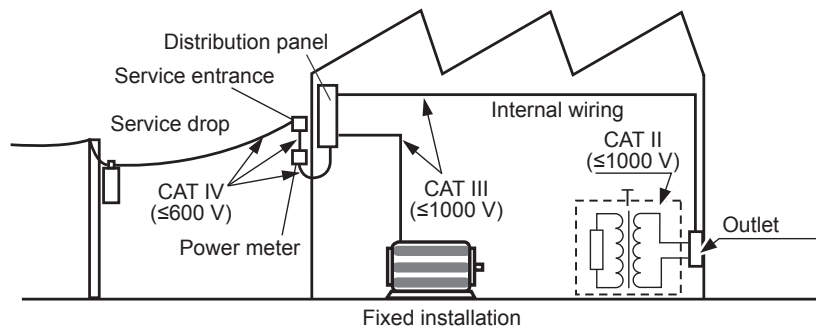

Usage Notes

Usage Notes

Follow these precautions to ensure safe operation and to obtain the full benefits of the various functions.

DANGER



Do not input a voltage or current in excess of the measurement range indicated by the ratings and specifications shown on instrument labeling. Doing so may damage the instrument or cause it to become hot, resulting in bodily injury.

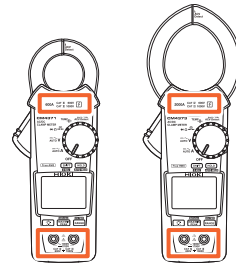

To prevent an electric shock, confirm that the white portion (insulation layer) inside the cable is not exposed. If a color inside the cable is exposed, do not use the cable.

 **WARNING**



Do not allow the instrument to get wet, and do not take measurements with wet hands. This may cause an electric shock.

To prevent electric shock, when measuring the voltage of a power line use a test lead that satisfies the following criteria:



- Conforms to safety standards IEC61010 or EN61010
- Of measurement category III or IV
- Its rated voltage is higher than the voltage to be measured

The optional test leads for this instrument conform to the safety standard EN61010. Use a test lead in accordance with its defined measurement category and rated voltage.

 **CAUTION**



Do not drop the instrument or subject it to excessive mechanical shock. Doing so may damage the surfaces at the tips of the clamp sensor's jaws, adversely affecting measurement.

Usage Notes

Current measurement precautions

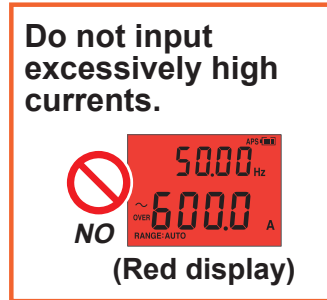
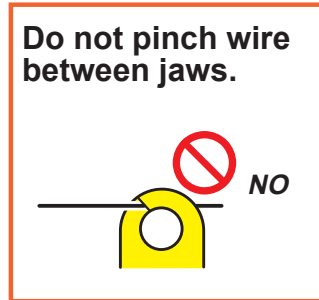
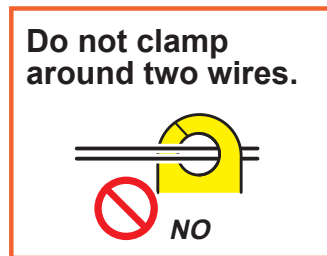

Part Names

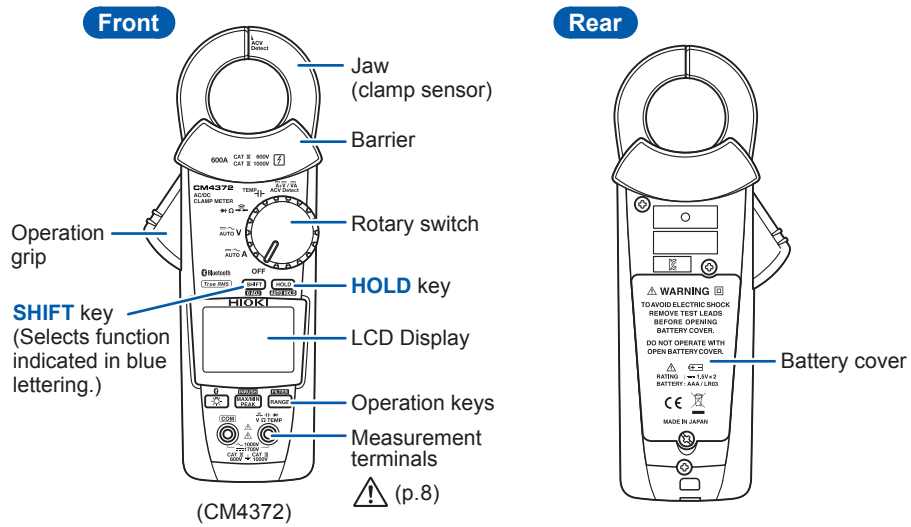

Insert/Replace Batteries

Insert/Replace Batteries

WARNING



- To prevent electric shock, disconnect test leads before inserting or replacing the batteries.
- Handle and dispose of batteries in accordance with local regulations.
- To prevent instrument damage or electric shock, use only the screw for securing the battery cover in place that are originally installed. If you have lost a screw or find that a screw is damaged, please contact your Hioki distributor for a replacement.

- The  indicator lights up when the battery charge diminishes. Replace the batteries as soon as possible.
The batteries may die if the backlight turns on or the buzzer sounds.
- After use, be sure to turn off the instrument.

Insert/Replace Batteries

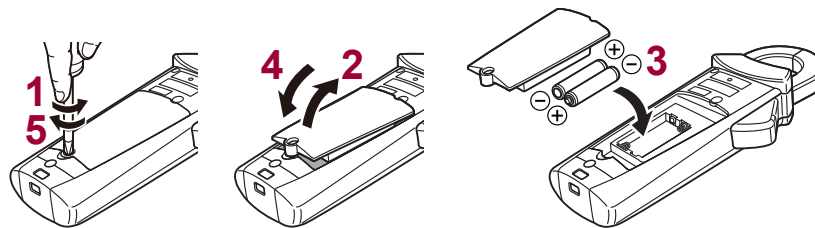

Battery indicator	Description
	Fully charged.
	As the battery charge diminishes, black charge bars disappear, one by one, from the left of the battery indicator.
	The battery voltage is low. Replace the batteries as soon as possible.
	(Blinks) The battery is exhausted. Replace the batteries.

Inspection Before Measurement

Inspection Before Measurement

Verify that the instrument operates normally to ensure that no damage occurred during storage or shipping. If you find any damage, contact your authorized Hioki distributor or reseller.

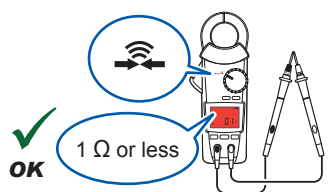
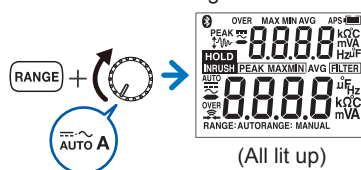
Check item	
<input type="checkbox"/> The battery cover is closed and its screw has been securely tightened.	<input type="checkbox"/> There is no damage to the test lead insulation, and neither the white sheathing nor metal conductor inside the wire are exposed.
<input type="checkbox"/> There is no foreign matter on the measurement terminals. (p.11)	<input type="checkbox"/> The instrument is neither damaged nor cracked.
<input type="checkbox"/> The test leads are not broken. 	<input type="checkbox"/> No indicators are missing.  <p>(All lit up)</p>
<input type="checkbox"/> The battery voltage (p.13) is sufficient.	

Current Measurement

1 

2 
 Press for 1 sec.
 → Perform zero adjustment

Frequency detection range of AC current

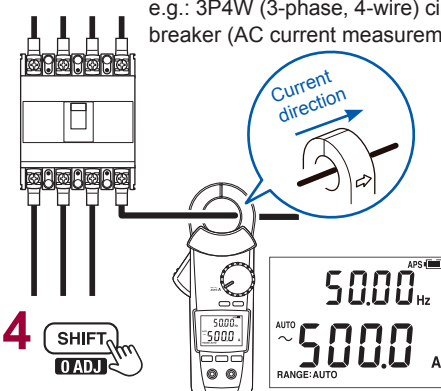

CM4371, CM4372:	
20.00 A range	4.00 A or more
600.0 A range	20.0 A or more
CM4373, CM4374:	
600.0 A range	40.0 A or more
2000 A range	200 A or more

3 **Clamp the wire.**
 e.g.: 3P4W (3-phase, 4-wire) circuit breaker (AC current measurement)



4 

DC current polarity detection function (p.35)
 If the measured value is negative, the buzzer will sound, and the display will turn red (threshold: -10 A).

AUTO →  →  →  → Hz
 (AUTO AC/DC) (AC A) (DC A) (AC+DC A)

Manual Hold / Auto Hold

MANUAL HOLD

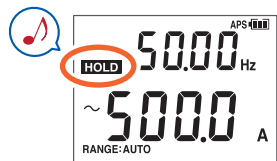

HOLD → Measured value retains.
AUTO HOLD

Pressing the **HOLD** key again cancels the measured value hold function.

AUTO HOLD

HOLD → **HOLD** blinks.
AUTO HOLD
Press for 1 sec.

→ To measured target
(Measured value stabilizes.)

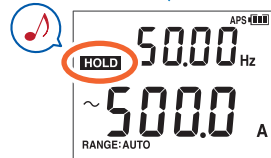

→ Disconnect

Measured value automatically retains.

Pressing the **HOLD** key for 1 second cancels the auto hold function.

Auto hold conditions

- Display value updates are stopped when the following two conditions are satisfied:
- When the measured value exceeds the threshold value described in the table in the next page. (voltage, current)
When the measured value is less than the threshold value described in the table in the next page. (resistance, continuity, diode)
 - When the range over which the measured value is fluctuating stabilizes within the fluctuation range described in the table in the next page.

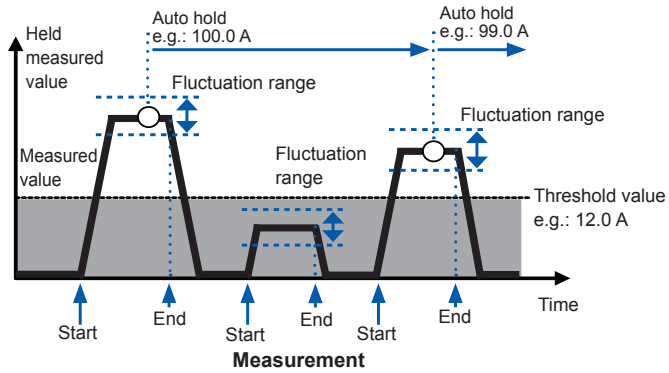

If the measured value falls below the threshold value (voltage, current) or exceeds the threshold value (resistance, continuity, diode) after display value updates are stopped, display value updates will stop once more if the two conditions are satisfied again.

Manual Hold / Auto Hold

Measurement function	Fluctuation range	Threshold value
AC current DC current AC+DC current	20.00 A range: within 100 counts 600.0 A range: within 120 counts 2000 A range: within 40 counts	20.00 A range: 100 counts 600.0 A range: 120 counts 2000 A range: 40 counts
AC voltage DC voltage (excluding the 600.0 mV range) AC+DC voltage	6.000 V/ 60.00 V/ 600.0 V range: within 120 counts 1000 V range: within 20 counts 1500 V range: within 30 counts	6.000 V/ 60.00 V/ 600.0 V range: 120 counts 1000 V range: 20 counts 1500 V range: within 30 counts
Resistance, Continuity	600.0 Ω /6.000 k Ω /60.00 k Ω /600.0 k Ω range: within 100 counts	600.0 Ω /6.000 k Ω /60.00 k Ω /600.0 k Ω range: 4900 counts
Diode	1.800 V range: within 40 counts	1.800 V range: 1460 counts

The auto hold function only operates for the above measurement functions.

Switching ranges

e.g. 1: Current measurement with the CM4373, CM4374

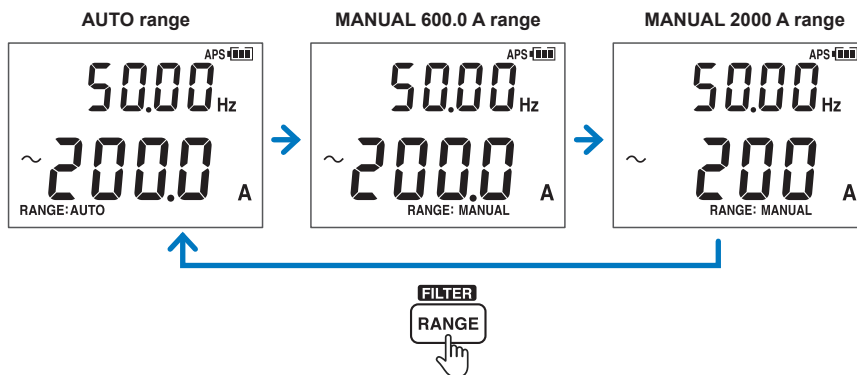

e.g. 2: Current measurement with the CM4371, CM4372



Filter Function

FILTER OFF

Measured value including noise

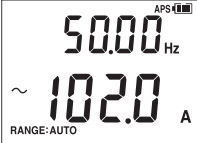

⇄

FILTER

RANGE

Press for 1 sec.

FILTER ON

Measured value with reduced noise

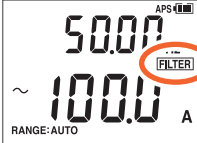

Frequency characteristics when using the filter

(600.0 AAC range, 100 A input)

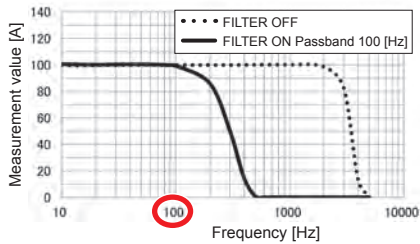









Turn off the filter function when performing measurement of power supply frequencies in excess of 100 Hz, for example on an aircraft or ship.



Filter OFF

MAX/MIN/AVG/PEAK

- 1 
- 2  **AUTO** →  →  →  → Hz
 (AUTO AC/DC) (AC A) (DC A) (AC+DC A)
 Can not be used at AUTO AC/DC.
- 3  **MAX** → **MIN** → **AVG** → **PEAK MAX** → **PEAK** → **MIN**
 Press for 1 sec. → Cancel
- 4  → Measured value retains.

The instrument performs true RMS measurement.

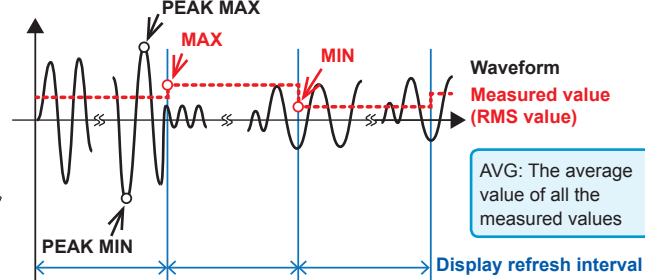

Waveform Measured value (RMS value)

AVG: The average value of all the measured values

Display refresh interval



Simultaneous display of DC current/voltage peak values

Simultaneous display of DC current/voltage peak values

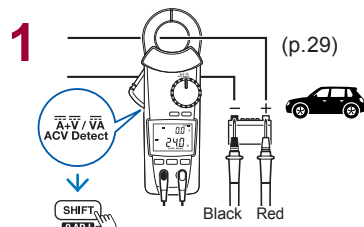

Voltage: 60.00 V range (fixed)
Current: 600.0 A range (fixed) (CM4371, CM4372)
Trigger level: ± 60 A
Current: 2000 A range (fixed) (CM4373, CM4374)
Trigger level: ± 200 A
The input current that equals to the trigger level or less does not trigger any peak measurement.

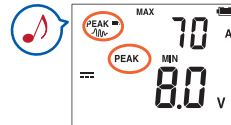
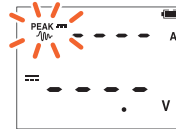

Simultaneous display of DC current/voltage peak values

4 **INRUSH**
MAX/MIN
PEAK

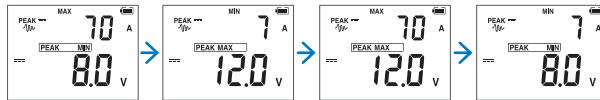

INRUSH
MAX/MIN
PEAK

Press for 1 sec.
→ Cancel

While measuring currents, the instrument, which measures peak values of current and voltage alternately, does not display any voltage values even when a voltage is applied. To measure peak values of each of current and voltage, perform measurement using the MAX/MIN/AVG/PEAK procedure.

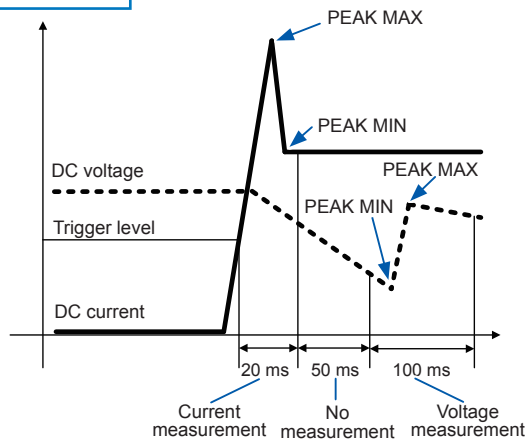

Backlight / Auto Power Save (APS)

Backlight

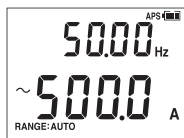

Backlight OFF

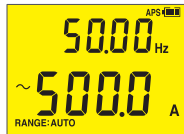

Backlight ON

Automatically switched off when the instrument is not in use for 40 s.

24

Auto Power Save (APS)

(Always on)

Cancellation method: p.35

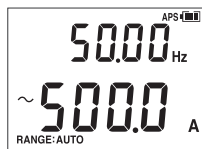

No operation for 15 min.

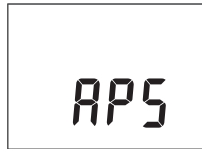

You can turn the display back on by pressing a key or by turning the rotary switch.



No operation for 45 min.

Power OFF

To restart the instrument, briefly set the rotary switch to "OFF."

Rush current (INRUSH)

1 MOTOR OFF



3 Press for 1 sec.
→Zero adjustment

4 Clamp the wire.

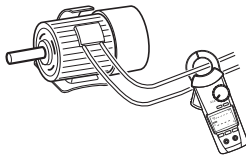

600.0 A range (fixed) (CM4371, CM4372)
Trigger level: ±10 A
2000 A range (fixed) (CM4373, CM4374)
Trigger level: ±100 A

5

Press for 1 sec.
→INRUSH ON

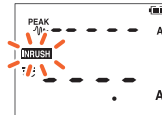

6 MOTOR ON

7 Rush current occurrence

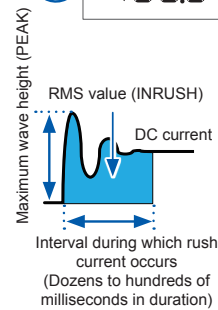
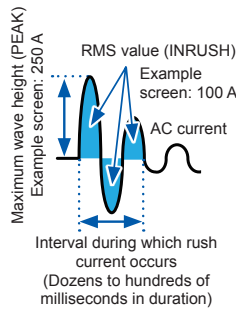

Other Measurement Functions

Voltage

e.g.: commercial power supply (AC voltage measurement)

1 AUTO V

2 Red Black

3 SHIFT
O/ADJ

AUTO (AUTO AC/DC)

~ (AC V)

≡ (DC V)

≡~ (AC+DC V)

Hz

EV

Do not input excessively high voltage.

NO 5000.
NO 1000 V
(Red display)

Do not touch.

NO

DC voltage polarity detection function (p.35)
If the measured value is negative, the buzzer will sound, and the display will turn red (threshold: -10 V).

Other Measurement Functions

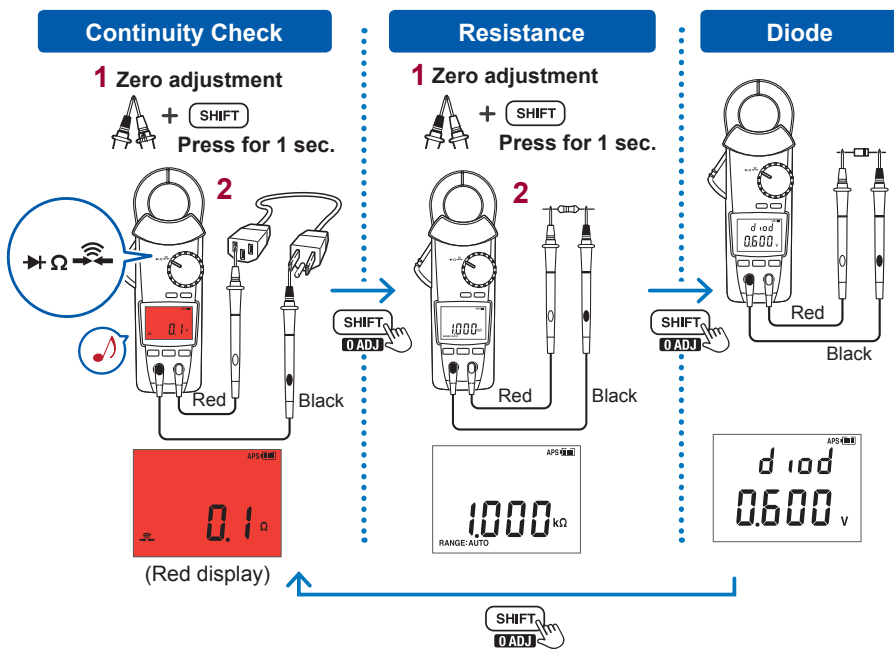

Other Measurement Functions

Capacitance

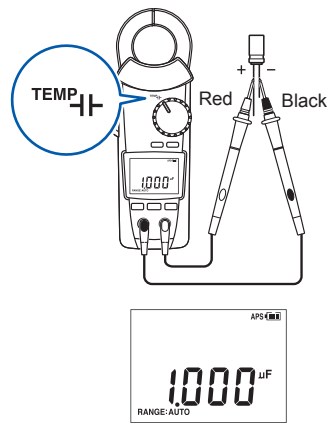

Temperature

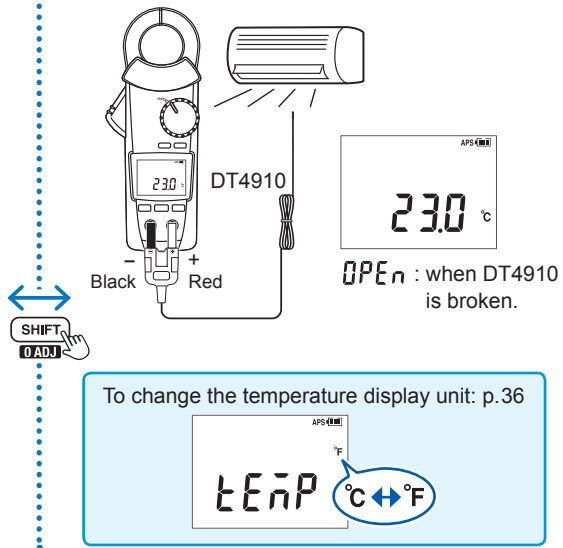

Other Measurement Functions

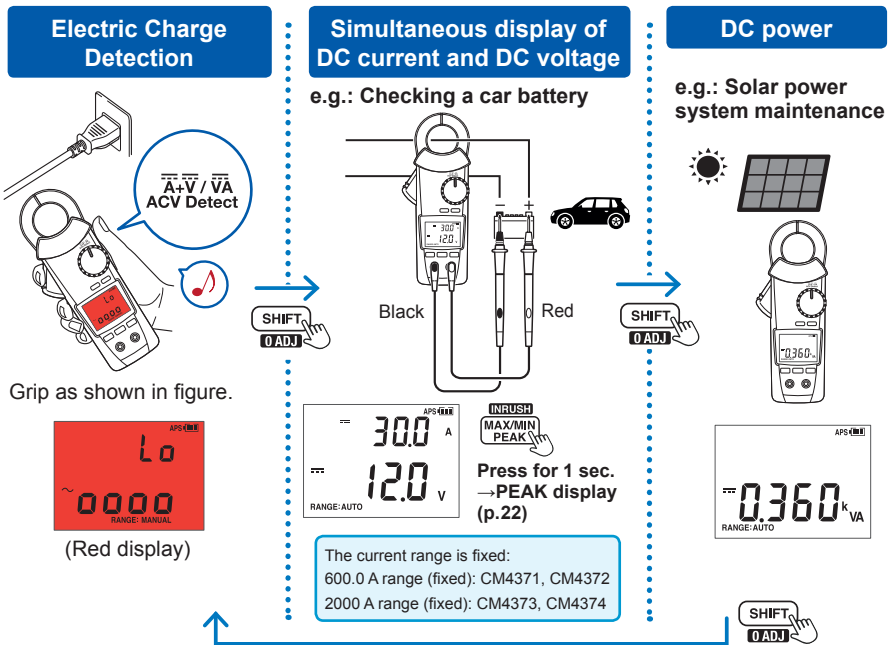

Bluetooth® Communications (only for CM4372, CM4374)

Bluetooth® Communications (only for CM4372, CM4374)

The CM4372 and CM4374 are clamp-style meters with Bluetooth® (Bluetooth® Low Energy) support. When the Bluetooth® function is enabled, you can review measurement data and create measurement reports on mobile devices (iPhone, iPad, iPad Mini, iPad Pro, iPod Touch, and Android™ devices). For more information about this functionality, see the [Help](#) function in the application software GENNECT Cross.

1 Install the GENNECT Cross on your mobile device. (p.31)



2 Enable the Bluetooth® function on the CM4372 or CM4374. (p.32)

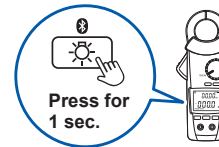

3 Launch the GENNECT Cross and pair it with the CM4372 or CM4374. (p.33)

4 Select the [General Measurement](#), [Logging \(Recording\)](#), or [Waveform Graph](#) function. (p.34)

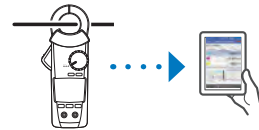

30

Bluetooth® Communications (only for CM4372, CM4374)

Installing the application software GENNECT Cross

Search for "GENNECT Cross" on the App Store from your iPhone, iPad or other Apple device, or on Google Play™ from your Android device. Then download and install the GENNECT Cross. You will need an Apple ID to download the app from the App Store, or a Google account to download the app from Google Play. For more information about how to register an account, contact the store at which you purchased your device.



- Because the CM4372 and CM4374 emit radio waves, use in a country or region where they have not been approved may be subject to fines or other penalties as a violation of applicable laws or regulations. For more information, see the attached "Precautions Concerning Use of Equipment That Emits Radio Waves" or go to our website.
- The CM4372 and CM4374 availability is limited to certain countries. For more information, contact your authorized Hioki distributor or reseller.
- Bluetooth® communications range varies greatly with distance from obstructions (walls, metal obstruction, etc.) as well as distance from the floor or ground. To ensure stable measurement, verify adequate signal strength.
- Although this app is provided free of charge, downloading or use of the app may incur Internet connection charges. Such charges are the sole responsibility of the user.
- This app is not guaranteed to operate on all mobile devices.

Bluetooth® Communications (only for CM4372, CM4374)

Turning on the Bluetooth® function

Bluetooth® function OFF

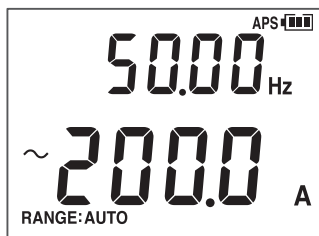

Bluetooth® function ON

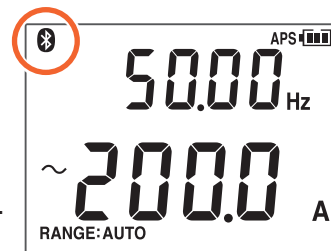

Bluetooth icon will flash when the instrument is connected to a mobile device.

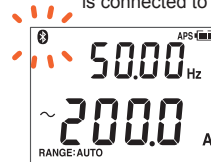

Bluetooth® Communications (only for CM4372, CM4374)

Pairing the app with the CM4372 or CM4374

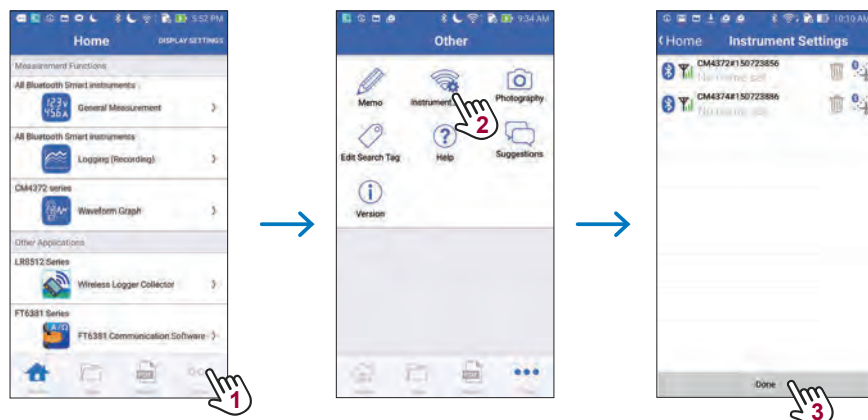

- When the app is launched for the first time (before being paired with any instrument), the **Instrument Settings** screen will be displayed.
- While the mobile device is displaying the **Instrument Settings** screen, simply move it close to a CM4372 or CM4374 to automatically pair it with the instrument (the app can be paired with up to 8 instruments).
- Allow about 5 to 30 seconds for the instrument to pair with the app after being turned on. If the instrument fails to pair within 1 minute, relaunch GENNECT Cross and cycle the instrument's power.

33

Bluetooth® Communications (only for CM4372, CM4374)

Making measurements with the Bluetooth® function

Select the **General Measurement**, **Logging (Recording)**, or **Waveform Graph** function on the **Home** screen. For more information about each function, see the **Help** function in the GENNECT Cross.



General Measurement

Saves measured values from multiple channels



Logging (Recording)

Simple logging (up to 24 hours)













Waveform Graph







Simple oscilloscope (voltage/current)

Power-on Option Table

+  Turn on the power while pressing the operation key.
(Turn the rotary switch from OFF.)

Setting	Operating instruction	Factory setting	Setting retained?
Canceling the auto power save (APS) function	 + 	ON	No (Set each time)
DC current and DC voltage polarity detection function (ON/OFF)	 + 	OFF	Yes
Displaying all indicators (Version of software/Model number)	 + 	-	-
Buzzer sound (ON/OFF)	 + 	ON	Yes
Automatic backlight deactivation (ON/OFF)	 + 	ON	Yes

Power-on Option Table

Setting	Operating instruction	Factory setting	Setting retained?
Switching the temperature unit	<p>  +  +  </p> <p>↓</p> <p>  +  </p> <p>Press for 1 sec.</p> <p>↓</p> <p>To change the temperature unit: </p> <p>↓</p> <p>To save the setting: </p> <p>Press for 1 sec.</p>	°C	Yes

Repairs, Inspections, and Cleaning

Cleaning

To clean the instrument, wipe it gently with a soft cloth moistened with water or mild detergent.

Troubleshooting

Symptom	Verification and/or Solution
<ul style="list-style-type: none"> The instrument is indicating an abnormal measured value for current. 	<ul style="list-style-type: none"> Is the measured current value too small for the instrument's measurement range? Wrap the wire around the clamp sensor one or more times. Each additional wrap of the wire will increase the measured value, so that wrapping it once yields a measured value that is twice the actual value and wrapping it twice yields a measured value that is three times the actual value.
	<ul style="list-style-type: none"> Are the tips of the clamp sensor's jaws open?
	<ul style="list-style-type: none"> Is the clamp sensor damaged? If the sensor is damaged or cracked, it will not be able to measure current accurately. Send the instrument for repair.

Repairs, Inspections, and Cleaning

Symptom	Verification and/or Solution
<ul style="list-style-type: none"> When readings from the instrument are compared with those of another clamp-on current meter, the measured values differ. 	<ul style="list-style-type: none"> The instrument cannot accurately measure waveforms that contain a component that falls outside the frequency characteristics range. Since the instrument performs true RMS measurement, it can accurately measure distorted waveforms. When measuring a distorted waveform, the measured value will differ from a clamp-on current meter that uses the averaging method.
<ul style="list-style-type: none"> The current value is larger than expected. A current value is displayed even though there is no input. 	<ul style="list-style-type: none"> The instrument cannot perform measurement accurately in the presence of a strong magnetic field from a source such as a nearby transformer or high-current circuit or in the presence of a strong electric field from a source such as a wireless device.
<ul style="list-style-type: none"> A sound is being emitted by the instrument's clamp sensor. 	<ul style="list-style-type: none"> The clamp sensor may emit sound when measuring AC currents in excess of approx. 500 A, however, there is no effect on the measurement.
<ul style="list-style-type: none"> The measured value does not appear. No measured value is displayed, even when the test leads are shorted. Zero adjustment is impossible. 	<ul style="list-style-type: none"> Check the continuity of the test leads. (p.27) If a wiring break is found, replace the test leads. Insert the test leads all the way. Use the proper measurement method. If no problem can be found, the instrument may be damaged. Send the instrument for repair. When performing current measurement, perform zero-adjustment while no measurement target is being clamped.

Error display

Error display	Description	Solution
Err 001	ROM error Program	When the error appears in the display, it is necessary to repair the instrument. Please contact your authorized Hioki distributor or reseller.
Err 002	ROM error Adjustment data	
Err 005	ADC error Hardware malfunction	
Err 008	Bluetooth® error Hardware malfunction (only for CM4372, CM4374)	

Specifications

Specifications

General Specifications

Dimensions	CM4371, CM4372: Approx. 65W × 215H × 35D mm (2.56"W × 8.46"H × 1.38"D) CM4373, CM4374: Approx. 65W × 250H × 35D mm (2.56"W × 9.84"H × 1.38"D) (excluding protruding parts, operation grip, and jaw)
Jaw dimensions	CM4371, CM4372: Approx. 69W × 14D mm (2.72"W × 0.55"D) CM4373, CM4374: Approx. 92W × 18D mm (3.62"W × 0.71"D)
Maximum measurable conductor diameter	CM4371, CM4372: ϕ 33 mm CM4373, CM4374: ϕ 55 mm
Mass	CM4371, CM4372: Approx. 340 g (12.0 oz.) (excluding batteries) CM4373, CM4374: Approx. 530 g (18.7 oz.) (excluding batteries)
Product warranty period	3 years (Measurement accuracy is defined in terms of a 1-year accuracy and a 3-year accuracy.) (3 years: reference values) Number of jaw open/close cycles: 30,000
Operating environment	Indoors, pollution degree 2, altitude up to 2000 m (6562 ft.)
Operating temperature and humidity	-25°C to 65°C (-13°F to 149°F), 90% RH or less (no condensation)
Storage temperature and humidity	-30°C to 70°C (-22°F to 158°F), 90% RH or less (no condensation)

Specifications

Dustproof and waterproof	Jaw, barrier: IP50 Grip: IP54 (when measuring an insulated conductor only) Risk of electric shock from the conductor being measured increases when wet.
---------------------------------	---

Electrical Characteristics

Display update rate (measured value)	<ul style="list-style-type: none">• Measured value excluding electrostatic capacity, frequency, and temperature: 5 times/s (after the range is fixed)• Electrostatic capacity: 0.5 to 5 times/s (The number of times varies depending on the capacitance.)• Frequency: 0.3 to 5 times/s (The number of times varies depending on the capacitance.)• Temperature: 1 times/s (including thermocouple wiring break check) (Defined within the measurement range (excluding range changes)).
Maximum terminal-to-terminal rated voltage	1000 V AC (up to 1 kHz) /1700 V DC
Maximum rated voltage to earth	1000 V AC (Measurement category III) 600 V AC (Measurement category IV) Anticipated transient overvoltage: 8000 V
Rated supply voltage	1.5 V DC ×2 LR03 Alkaline battery ×2

Specifications

Continuous operating time	<ul style="list-style-type: none">• Approx. 45 hours, at 23°C (73.4°F): 10 AAC measurement (CM4371, CM4372), 100 AAC measurement (CM4373, CM4374) Backlight OFF, Bluetooth OFF• Approx. 24 hours, at 23°C (73.4°F): 10 AAC measurement (CM4372), 100 AAC measurement (CM4374) Backlight OFF, Bluetooth ON
----------------------------------	--

Standards

Safety	EN61010
EMC	EN61326

Specification for Model DT4910 Thermocouples (K)

Sensor type	Thermocouples (K)
Tolerance	±2.5°C (Class 2)
Temperature measuring junction	Exposed type (welding)
Sensor length	Approx. 800 mm
Measuring temperature	-40°C to 260°C (-40°F to 500°F) (temperature detector)
Operating temperature	-15°C to 55°C (5°F to 131°F)
Storage temperature	-30°C to 60°C (-22°F to 140°F)

CM4372, CM4374 Individual Specifications

Bluetooth® Function

Bluetooth® communications function	Display of measured values on a smartphone or a tablet while using Bluetooth® communications.
---	---

External Interface Specifications

Interface	Bluetooth® 4.0LE ( Bluetooth)
Antenna power	Maximum +0 dBm (1 mW)
Communications range	Approx. 10 m (line of sight)
Communications profile	GATT (Generic Attribute Profile)
Supported devices	Supported iOS terminals: iOS 10 or later (models supporting Bluetooth low energy only) Supported Android terminals: Android 4.3 or later (models supporting Bluetooth low energy only)

Specifications

Accuracy specifications and measurement specifications

Guaranteed accuracy period	1 year "Accuracy shown in accuracy table" 3 years (reference values) "Accuracy shown in accuracy table ×1.5"
Guaranteed accuracy period after adjustment made by Hioki	1 year
Guaranteed accuracy for temperature and humidity	23°C±5°C (73°F±9°F), 90% RH or less (no condensation)
Temperature characteristic	Within the operating temperature range, add "measurement accuracy × 0.1/°C" (excluding 23°C±5°C (73°F±9°F)).
Other conditions	When using the L4931 Extension Cable Set, accuracy is guaranteed for up to two connected cables (totaling 3 m in length).
AC measurement method	True RMS measurement
Conditions of AC accuracy guarantee	Sine wave input

AC current/DC current/AC+DC current common specification

Effects of conductor position	CM4371, CM4372: within $\pm 1.5\%$ rdg. CM4373, CM4374: within $\pm 1.0\%$ rdg. At all positions around the jaw's center-point reference
Maximum allowable input (AC/DC)	CM4371, CM4372: 600 A continuous CM4373, CM4374: 2000 A continuous Frequency derating characteristics with continuous input (See the graph below)

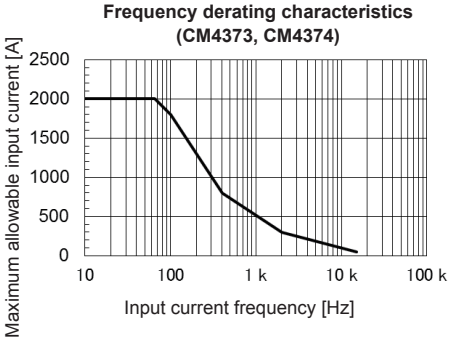
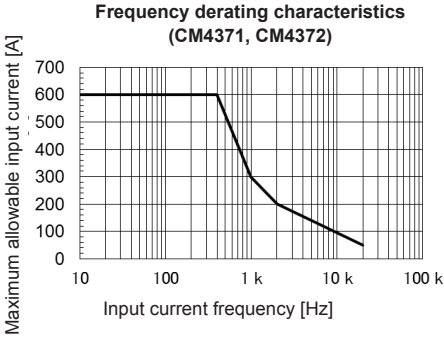

Accuracy Table

Accuracy Table

Accuracy

We define measurement tolerances in terms of f.s. (full scale), rdg. (reading) and dgt. (digit) values with the following meanings:

f.s. (maximum display value/range)	The maximum displayable value. This is usually the name of the currently selected range.
rdg. (displayed value)	The value currently being measured and displayed on the measuring instrument.
dgt. (resolution)	The smallest displayable unit on a digital measuring instrument, i.e., the input value that causes the digital display to show a "1" as the least-significant digit.

1 AC current 20.00 A/600.0 A (CM4371, CM4372)

Conditions of guaranteed accuracy: After zero adjustment has been performed

Zero-display range: 5 counts or less

Coupling type: AC coupling

Crest factor: For the 20.00 A range, 7.5
For the 600.0 A range (500.0 A or less), 3
For the 600.0 A range (greater than 500.0 A and less than or equal to 600.0 A), 2.5

Peak detection time width: 1 ms or more (Filter off)

46

Accuracy Table

AC current (Measurement value/MAX/MIN/AVG)

Range (Accuracy guarantee range)	Resolution	Accuracy guarantee frequency range	Measurement accuracy	
			Filter off	Filter on
20.00 A (1.00 A to 20.00 A)	0.01 A	10 Hz≤f<45 Hz	±1.8% rdg.±0.10 A	±2.3% rdg.±0.10 A
		45 Hz≤f≤66 Hz	±1.3% rdg.±0.08 A	±1.8% rdg.±0.08 A
		66 Hz<f≤1 kHz	±2.0% rdg.±0.10 A	-
600.0 A (1.0 A to 600.0 A)	0.1 A	10 Hz≤f<45 Hz	±1.8% rdg.±0.5 A	±2.3% rdg.±0.5 A
		45 Hz≤f≤66 Hz	±1.3% rdg.±0.3 A	±1.8% rdg.±0.3 A
		66 Hz<f≤1 kHz	±2.0% rdg.±0.5 A	-

Auto range movement threshold: 2000 counts or more for upper range, 180 counts or less for lower range.

AC current (PEAK MAX/PEAK MIN)

Range (Accuracy guarantee range)	Resolution	Accuracy guarantee frequency range	Measurement accuracy
20.00 A (±1.0 A to ±150.0 A)	0.1 A	10 Hz≤f<45 Hz	±1.8% rdg.±0.7 A
		45 Hz≤f≤66 Hz	±1.3% rdg.±0.7 A
		66 Hz<f≤1 kHz	±2.0% rdg.±0.7 A
600.0 A (±10 A to ±1500 A)	1 A	10 Hz≤f<45 Hz	±1.8% rdg.±7 A
		45 Hz≤f≤66 Hz	±1.3% rdg.±7 A
		66 Hz<f≤1 kHz	±2.0% rdg.±7 A

Accuracy Table

2 DC current and auto A DC detection 20.00 A/600.0 A (CM4371, CM4372)

Conditions of guaranteed accuracy: After zero adjustment has been performed

Zero-display range: 5 counts or less

Coupling type: DC coupling

Peak detection time width: 1 ms or more (Filter off)

DC current (Measurement value/MAX/MIN/AVG)

Range	(Accuracy guarantee range)	Resolution	Measurement accuracy (Values apply regardless of whether the filter is on or off.)
20.00 A	(±1.00 A to ±20.00 A)	0.01 A	±1.3% rdg.±0.08 A
600.0 A	(±1.0 A to ±600.0 A)	0.1 A	±1.3% rdg.±0.3 A

Auto range movement threshold: 2000 counts or more for upper range, 180 counts or less for lower range.

DC current (PEAK MAX/PEAK MIN)

Range	(Accuracy guarantee range)	Resolution	Measurement accuracy
20.00 A	(±1.0 A to ±150.0 A)	0.1 A	±1.3% rdg.±0.7 A
600.0 A	(±10 A to ±1500 A)	1 A	±1.3% rdg.±7 A

3 AC+DC current and auto A AC detection 20.00 A/600.0 A (CM4371, CM4372)

Conditions of guaranteed accuracy:	After zero adjustment has been performed
Zero-display range:	5 counts or less
Coupling type:	DC coupling
Crest factor:	For the 20.00 A range, 7.5 For the 600.0 A range (500.0 A or less), 3 For the 600.0 A range (greater than 500.0 A and less than or equal to 600.0 A), 2.5
Peak detection time width:	1 ms or more (Filter off)

AC+DC current (Measurement value/MAX/MIN/AVG)

Range (Accuracy guarantee range)	Resolution	Accuracy guarantee frequency range	Measurement accuracy	
			Filter off	Filter on
20.00 A (1.00 A to 20.00 A)	0.01 A	10 Hz≤f<45 Hz	±1.8% rdg.±0.10 A	±2.3% rdg.±0.10 A
		DC, 45 Hz≤f≤66 Hz	±1.3% rdg.±0.13 A	±1.8% rdg.±0.13 A
		66 Hz<f≤1 kHz	±2.0% rdg.±0.10 A	-
600.0 A (1.0 A to 600.0 A)	0.1 A	10 Hz≤f<45 Hz	±1.8% rdg.±0.7 A	±2.3% rdg.±0.7 A
		DC, 45 Hz≤f≤66 Hz	±1.3% rdg.±1.3 A	±1.8% rdg.±1.3 A
		66 Hz<f≤1 kHz	±2.0% rdg.±0.7 A	-

Auto range movement threshold: 2000 counts or more for upper range, 180 counts or less for lower range.

Accuracy Table

AC+DC current (PEAK MAX/PEAK MIN)

Range	(Accuracy guarantee range)	Resolution	Accuracy guarantee frequency range	Measurement accuracy
20.00 A	(±1.0 A to ±150.0 A)	0.1 A	10 Hz≤f<45 Hz	±1.8% rdg.±0.7 A
			DC, 45 Hz≤f≤66 Hz	±1.3% rdg.±0.7 A
			66 Hz<f≤1 kHz	±2.0% rdg.±0.7 A
600.0 A	(±10 A to ±1500 A)	1 A	10 Hz≤f<45 Hz	±1.8% rdg.±7 A
			DC, 45 Hz≤f≤66 Hz	±1.3% rdg.±7 A
			66 Hz<f≤1 kHz	±2.0% rdg.±7 A

4 Rush current (INRUSH) 600.0 A (CM4371, CM4372)

Conditions of guaranteed accuracy: After zero adjustment has been performed
 INRUSH trigger level: For 600.0 A range, detection of current of +10 A or more or -10 A or less
 Coupling type: DC coupling
 Crest factor: For the 600.0 A range (500.0 A or less), 3
 For the 600.0 A range (greater than 500.0 A and less than or equal to 600.0 A), 2.5
 Peak detection time width: 1 ms or more

Accuracy Table

Rush Current (INRUSH)

Range (Accuracy guarantee range)	Resolution	Accuracy guarantee frequency range	Measurement accuracy (Values apply regardless of whether the filter is on or off.)
600.0 A (10.0 A to 600.0 A)	0.1 A	DC, 20 Hz ≤ f ≤ 500 Hz	±5.0% rdg. ±1.3 A

Rush Current (INRUSH peak value)

Range (Accuracy guarantee range)	Resolution	Accuracy guarantee frequency range	Measurement accuracy
600.0 A (±10 A to ±1500 A)	1 A	DC, 20 Hz ≤ f ≤ 500 Hz	±6.0% rdg. ±10 A

5 AC current 600.0 A/2000 A (CM4373, CM4374)

Conditions of guaranteed accuracy: After zero adjustment has been performed
 Zero-display range: 5 counts or less
 Coupling type: AC coupling
 Crest factor: For the 600.0 A range (500.0 A or less), 3
 For the 600.0 A range (greater than 500.0 A and less than or equal to 600.0 A), 2.5
 For the 2000 A range (1000 A or less), 2.84
 For the 2000 A range (greater than 1000 A and less than or equal to 2000 A), 1.42
 Peak detection time width: 1 ms or more (Filter off)

Accuracy Table

AC current (Measurement value/MAX/MIN/AVG)

Range	(Accuracy guarantee range)	Resolution	Accuracy guarantee frequency range	Measurement accuracy	
				Filter off	Filter on
600.0 A	(1.0 A to 600.0 A)*	0.1 A	10 Hz≤f<45 Hz	±1.8% rdg.±0.5 A	±2.3% rdg.±0.5 A
			45 Hz≤f≤66 Hz	±1.3% rdg.±0.3 A	±1.8% rdg.±0.3 A
			66 Hz<f≤1 kHz	±2.0% rdg.±0.5 A	-
2000 A	(10 A to 1800 A)	1 A	10 Hz≤f<45 Hz	±1.8% rdg.±5 A	±2.3% rdg.±5 A
			45 Hz≤f≤66 Hz	±1.3% rdg.±3 A	±1.8% rdg.±3 A
			66 Hz<f≤1 kHz	±2.0% rdg.±5 A	-
	(1801 A to 2000 A)	1 A	10 Hz≤f<45 Hz	±2.8% rdg.±5 A	±3.3% rdg.±5 A
			45 Hz≤f≤66 Hz	±2.3% rdg.±3 A	±2.8% rdg.±3 A
			66 Hz<f≤1 kHz	-	-

Auto range movement threshold: 6000 counts or more for upper range, 540 counts or less for lower range.

* For 30.0 A or less, add 0.5 A to the measurement accuracy.

Accuracy Table

AC current (PEAK MAX/PEAK MIN)

Range	(Accuracy guarantee range)	Resolution	Accuracy guarantee frequency range	Measurement accuracy
600.0 A	(±10 A to ±1500 A)	1 A	10 Hz≤f<45 Hz	±1.8% rdg.±7 A
			45 Hz≤f≤66 Hz	±1.3% rdg.±7 A
			66 Hz<f≤1 kHz	±2.0% rdg.±7 A
2000 A	(±10 A to ±2300 A)	1 A	10 Hz≤f<45 Hz	±1.8% rdg.±7 A
			45 Hz≤f≤66 Hz	±1.3% rdg.±7 A
			66 Hz<f≤1 kHz	±2.0% rdg.±7 A
	(±2301 A to ±2840 A)	1 A	10 Hz≤f<45 Hz	±6.5% rdg.±7 A
			45 Hz≤f≤66 Hz	±6.0% rdg.±7 A
			66 Hz<f≤1 kHz	-

6 DC current and auto A DC detection 600.0 A/2000 A (CM4373, CM4374)

Conditions of guaranteed accuracy: After zero adjustment has been performed
 Zero-display range: 5 counts or less
 Coupling type: DC coupling
 Peak detection time width: 1 ms or more (Filter off)

Accuracy Table

DC current (Measurement value/MAX/MIN/AVG)

Range	(Accuracy guarantee range)	Resolution	Measurement accuracy (Values apply regardless of whether the filter is on or off.)
600.0 A	(±1.0 A to ±600.0 A)*	0.1 A	±1.3% rdg.±0.3 A
2000 A	(±10 A to ±2000 A)	1 A	±1.3% rdg.±3 A

Auto range movement threshold: 6000 counts or more for upper range, 540 counts or less for lower range.
 * For 30.0 A or less, add 0.5 A to the measurement accuracy.

DC current (PEAK MAX/PEAK MIN)

Range	(Accuracy guarantee range)	Resolution	Measurement accuracy
600.0 A	(±10 A to ±1500 A)	1 A	±1.3% rdg.±7 A
2000 A	(±10 A to ±2300 A)	1 A	±1.3% rdg.±7 A
	(±2301 A to ±2840 A)	1 A	±6.0% rdg.±7 A

Accuracy Table

7 AC+DC current and auto A AC detection 600.0 A/2000 A (CM4373, CM4374)

Conditions of guaranteed

accuracy: After zero adjustment has been performed
 Zero-display range: 5 counts or less
 Coupling type: DC coupling
 Crest factor: For the 600.0 A range (500.0 A or less), 3
 For the 600.0 A range (greater than 500.0 A and less than or equal to 600.0 A), 2.5
 For the 2000 A range (1000 A or less), 2.84
 For the 2000 A range (greater than 1000 A and less than or equal to 2000 A), 1.42

Peak detection time width: 1 ms or more (Filter off)

AC+DC current (Measurement value/MAX/MIN/AVG)

Range	(Accuracy guarantee range)	Resolution	Accuracy guarantee frequency range	Measurement accuracy	
				Filter off	Filter on
600.0 A	(1.0 A to 600.0 A)	0.1 A	10 Hz≤f<45 Hz	±1.8% rdg.±0.7 A	±2.3% rdg.±0.7 A
			DC, 45 Hz≤f≤66 Hz	±1.3% rdg.±1.3 A	±1.8% rdg.±1.3 A
			66 Hz<f≤1 kHz	±2.0% rdg.±0.7 A	-
2000 A	(10 A to 1800 A)	1 A	10 Hz≤f<45 Hz	±1.8% rdg.±7 A	±2.3% rdg.±7 A
			DC, 45 Hz≤f≤66 Hz	±1.3% rdg.±13 A	±1.8% rdg.±13 A
			66 Hz<f≤1 kHz	±2.0% rdg.±7 A	-
	(1801 A to 2000 A)	1 A	10 Hz≤f<45 Hz	±2.8% rdg.±7 A	±3.3% rdg.±7 A
			DC, 45 Hz≤f≤66 Hz	±2.3% rdg.±13 A	±2.8% rdg.±13 A
			66 Hz<f≤1 kHz	-	-

Auto range movement threshold: 6000 counts or more for upper range, 540 counts or less for lower range.

Accuracy Table

AC+DC current (PEAK MAX/PEAK MIN)

Range	(Accuracy guarantee range)	Resolution	Accuracy guarantee frequency range	Measurement accuracy
600.0 A	(±10 A to ±1500 A)	1 A	10 Hz≤f<45 Hz	±1.8% rdg.±7 A
			DC, 45 Hz≤f≤66 Hz	±1.3% rdg.±7 A
			66 Hz<f≤1 kHz	±2.0% rdg.±7 A
2000 A	(±10 A to ±2300 A)	1 A	10 Hz≤f<45 Hz	±1.8% rdg.±7 A
			DC, 45 Hz≤f≤66 Hz	±1.3% rdg.±7 A
			66 Hz<f≤1 kHz	±2.0% rdg.±7 A
	(±2301 A to ±2840 A)	1 A	10 Hz≤f<45 Hz	±6.5% rdg.±7 A
			DC, 45 Hz≤f≤66 Hz	±6.0% rdg.±7 A
			66 Hz<f≤1 kHz	-

8 Rush Current (INRUSH) 2000 A (CM4373, CM4374)

Conditions of guaranteed accuracy: After zero adjustment has been performed
 INRUSH trigger level: For 2000 A range, detection of current of +100 A or more or -100 A or less
 Coupling type: DC coupling
 Crest factor: For the 2000 A range (1000 A or less), 2.84
 For the 2000 A range (greater than 1000 A and less than or equal to 2000 A), 1.42
 Peak detection time width: 1 ms or more

Accuracy Table

Rush Current (INRUSH) of AC+DC current

Range	(Accuracy guarantee range)	Resolution	Accuracy guarantee frequency range	Measurement accuracy
2000 A	(100 A to 1800 A)	1 A	DC, 20 Hz≤f≤500 Hz	±3.3% rdg.±13 A
	(1801 A to 2000 A)	1 A	DC, 20 Hz≤f≤66 Hz	±5.0% rdg.±13 A

Rush Current (INRUSH peak value) of AC+DC current

Range	(Accuracy guarantee range)	Resolution	Accuracy guarantee frequency range	Measurement accuracy
2000 A	(±100 A to ±2300 A)	10 A	DC, 20 Hz≤f≤500 Hz	±6.0% rdg.±100 A
	(±2310 A to ±2840 A)	10 A	DC, 20 Hz≤f≤66 Hz	±8.0% rdg.±100 A

9 AC voltage

CMRR:	-60 dB or more (DC, 50 Hz/60 Hz, 1 kΩ unbalance)
Zero-display range:	5 counts or less
Coupling type:	AC coupling
Crest factor:	For 4000 counts or less, 3
	For greater than 4000 counts and less than or equal to 6000 counts, 2
	For 850 V or less, 2 (1000 V range only)
Peak detection time width:	For greater than 850 V and less than or equal to 1000 V, 1.7
Overload protection:	1 ms or more (Filter off)
Transient overvoltage:	Lower of 1870 V DC/1100 V AC or $2 \times 10^7 \text{ V} \cdot \text{Hz}$ (energized for 1 minute)
	8000 V

Accuracy Table

AC voltage (Measurement value/MAX/MIN/AVG)

Range	(Accuracy guarantee range)	Resolution	Accuracy guarantee frequency range*	Measurement accuracy		Input impedance (at AC 50 Hz)
				Filter off	Filter on	
6.000 V	(0.000 V to 0.299 V)	0.001 V	15 Hz≤f<45 Hz	±1.5% rdg.±0.015 V	±2.0% rdg.±0.015 V	3.2 MΩ±5%
			45 Hz≤f≤66 Hz	±0.9% rdg.±0.013 V	±1.4% rdg.±0.013 V	
			66 Hz<f≤1 kHz	±1.5% rdg.±0.015 V	-	
6.000 V	(0.300 V to 6.000 V)	0.001 V	15 Hz≤f<45 Hz	±1.5% rdg.±0.005 V	±2.0% rdg.±0.005 V	3.2 MΩ±5%
			45 Hz≤f≤66 Hz	±0.9% rdg.±0.003 V	±1.4% rdg.±0.003 V	
			66 Hz<f≤1 kHz	±1.5% rdg.±0.005 V	-	
60.00 V	(3.00 V to 60.00 V)	0.01 V	15 Hz≤f<45 Hz	±1.5% rdg.±0.05 V	±2.0% rdg.±0.05 V	3.1 MΩ±5%
			45 Hz≤f≤66 Hz	±0.9% rdg.±0.03 V	±1.4% rdg.±0.03 V	
			66 Hz<f≤1 kHz	±1.5% rdg.±0.05 V	-	
600.0 V	(30.0 V to 600.0 V)	0.1 V	15 Hz≤f<45 Hz	±1.5% rdg.±0.5 V	±2.0% rdg.±0.5 V	3.0 MΩ±5%
			45 Hz≤f≤66 Hz	±0.9% rdg.±0.3 V	±1.4% rdg.±0.3 V	
			66 Hz<f≤1 kHz	±1.5% rdg.±0.5 V	-	
1000 V	(50 V to 1000 V)	1 V	15 Hz≤f<45 Hz	±1.5% rdg.±5 V	±2.0% rdg.±5 V	3.0 MΩ±5%
			45 Hz≤f≤66 Hz	±0.9% rdg.±3 V	±1.4% rdg.±3 V	
			66 Hz<f≤1 kHz	±1.5% rdg.±5 V	-	

Auto range movement threshold: 6000 counts or more for upper range, 540 counts or less for lower range.

* Frequency range of 15 Hz≤f<20 Hz is designed value.

Within the frequency range of f<45 Hz, the accuracy guarantee assumes a superposed DC voltage of less than 500 V.

Accuracy Table

AC voltage (PEAK MAX/PEAK MIN)

Range	(Accuracy guarantee range)	Resolution	Accuracy guarantee frequency range* ¹	Measurement accuracy
6.000 V	(0 V to ± 12.00 V)	0.01 V	15 Hz \leq f<45 Hz	$\pm 1.8\%$ rdg. ± 0.07 V
			45 Hz \leq f \leq 66 Hz	$\pm 1.5\%$ rdg. ± 0.07 V
			66 Hz<f \leq 1 kHz	$\pm 1.8\%$ rdg. ± 0.07 V
60.00 V	(± 3.0 V to ± 120.0 V)	0.1 V	15 Hz \leq f<45 Hz	$\pm 1.8\%$ rdg. ± 0.7 V
			45 Hz \leq f \leq 66 Hz	$\pm 1.5\%$ rdg. ± 0.7 V
			66 Hz<f \leq 1 kHz	$\pm 1.8\%$ rdg. ± 0.7 V
600.0 V	(± 30 V to ± 1000 V)* ²	1 V	15 Hz \leq f<45 Hz	$\pm 1.8\%$ rdg. ± 7 V
			45 Hz \leq f \leq 66 Hz	$\pm 1.5\%$ rdg. ± 7 V
			66 Hz<f \leq 1 kHz	$\pm 1.8\%$ rdg. ± 7 V
1000 V	(± 50 V to ± 1000 V)* ³	1 V	15 Hz \leq f<45 Hz	$\pm 1.8\%$ rdg. ± 7 V
			45 Hz \leq f \leq 66 Hz	$\pm 1.5\%$ rdg. ± 7 V
			66 Hz<f \leq 1 kHz	$\pm 1.8\%$ rdg. ± 7 V

Maximum display count for all ranges: 1200/1700 counts

*1 Frequency range of 15 Hz \leq f<20 Hz is designed value.

Within the frequency range of f<45 Hz, the accuracy guarantee assumes a superposed DC voltage of less than 500 V.

*2 Values of up to ± 1200 V are displayed, but accuracy is not defined for display values in excess of 1000 V (which are provided as reference values).

*3 Values of up to ± 1700 V are displayed, but accuracy is not defined for display values in excess of 1000 V (which are provided as reference values).

Accuracy Table

10 DC voltage and auto V DC detection

NMRR: -60 dB or more (50 Hz/60 Hz)
 CMRR: -100 dB or more (DC, 50 Hz/60 Hz, 1 kΩ unbalance)
 Coupling type: DC coupling
 Peak detection time width: 1 ms or more (Filter off)
 Overload protection: Lower of 1870 V DC/1100 V AC or 2×10^7 V • Hz (energized for 1 minute)

DC voltage (Measurement value/MAX/MIN/AVG)

Range	(Accuracy guarantee range)	Resolution	Measurement accuracy	Input impedance (DC input)
600.0 mV	(0.0 mV to ±600.0 mV)	0.1 mV	±0.5% rdg.±0.5 mV	6.7 MΩ±5%
6.000 V	(0.000 V to ±6.000 V)	0.001 V	±0.5% rdg.±0.003 V	6.7 MΩ±5%
60.00 V	(0.00 V to ±60.00 V)	0.01 V	±0.5% rdg.±0.03 V	6.1 MΩ±5%
600.0 V	(0.0 V to ±600.0 V)	0.1 V	±0.5% rdg.±0.3 V	6.0 MΩ±5%
1500 V*	(0 V to ±1000 V)	1 V	±0.5% rdg.±3 V	6.0 MΩ±5%
	(±1001 V to ±1700 V)	1 V	±2.0% rdg.±5 V	

Auto range movement threshold: 6000 counts or more for upper range, 540 counts or less for lower range.
 * In the 1500 V range, the instrument can withstand input of up to 1000 V continuously or input in excess of 1000 V for no greater than 1 minute.

Accuracy Table

DC voltage (PEAK MAX/PEAK MIN Zero to Peak)

Range	(Accuracy guarantee range)	Resolution	Measurement accuracy
600.0 mV	(0 mV to ±1200 mV)	1 mV	±1.0% rdg.±7 mV
6.000 V	(0.00 V to ±12.00 V)	0.01 V	±1.0% rdg.±0.07 V
60.00 V	(0.0 V to ±120.0 V)	0.1 V	±1.0% rdg.±0.7 V
600.0 V	(0 V to ±1000 V)	1 V	±1.0% rdg.±7 V
	(±1001 V to ±1200 V)	1 V	±5.0% rdg.±7 V
1500 V	(0 V to ±1000 V)	1 V	±1.0% rdg.±7 V
	(±1001 V to ±1700 V)	1 V	±5.0% rdg.±7 V

11 AC+DC voltage and auto V AC detection

CMRR:	-60 dB or more (DC, 50 Hz/60 Hz, 1 kΩ unbalance)
Zero-display range:	5 counts or less
Coupling type:	DC coupling
Crest factor:	For 4000 counts or less, 3
	For greater than 4000 counts and less than or equal to 6000 counts, 2
	For 850 V or less, 2 (1000 V range only)
	For greater than 850 V and less than or equal to 1000 V, 1.7
Peak detection time width:	1 ms or more (Filter off)
Overload protection:	Lower of 1870 V DC/1100 V AC or 2×10^7 V · Hz (energized for 1 minute)
Transient overvoltage:	8000 V

Accuracy Table

AC+DC voltage (Measurement value/MAX/MIN/AVG)

Range (Accuracy guarantee range)	Resolution	Accuracy guarantee frequency range*	Measurement accuracy		Input impedance (DC input, AC 50 Hz input)
			Filter off	Filter on	
6.000 V (0.000 V to 0.299 V)	0.001 V	10 Hz≤f<45 Hz	±1.5% rdg.±0.023 V	±2.0% rdg.±0.023 V	DC: 6.7 MΩ±5% AC: 3.2 MΩ±5%
		DC, 45 Hz≤f≤66 Hz	±1.0% rdg.±0.023 V	±1.5% rdg.±0.023 V	
		66 Hz<f≤1 kHz	±1.5% rdg.±0.023 V	-	
6.000 V (0.300 V to 6.000 V)	0.001 V	10 Hz≤f<45 Hz	±1.5% rdg.±0.013 V	±2.0% rdg.±0.013 V	DC: 6.7 MΩ±5% AC: 3.2 MΩ±5%
		DC, 45 Hz≤f≤66 Hz	±1.0% rdg.±0.013 V	±1.5% rdg.±0.013 V	
		66 Hz<f≤1 kHz	±1.5% rdg.±0.013 V	-	
60.00 V (3.00 V to 60.00 V)	0.01 V	10 Hz≤f<45 Hz	±1.5% rdg.±0.13 V	±2.0% rdg.±0.13 V	DC: 6.1 MΩ±5% AC: 3.1 MΩ±5%
		DC, 45 Hz≤f≤66 Hz	±1.0% rdg.±0.13 V	±1.5% rdg.±0.13 V	
		66 Hz<f≤1 kHz	±1.5% rdg.±0.13 V	-	
600.0 V (30.0 V to 600.0 V)	0.1 V	10 Hz≤f<45 Hz	±1.5% rdg.±0.7 V	±2.0% rdg.±0.7 V	DC: 6.0 MΩ±5% AC: 3.0 MΩ±5%
		DC, 45 Hz≤f≤66 Hz	±1.0% rdg.±0.7 V	±1.5% rdg.±0.7 V	
		66 Hz<f≤1 kHz	±1.5% rdg.±0.7 V	-	
1000 V (50 V to 1000 V)	1 V	10 Hz≤f<45 Hz	±1.5% rdg.±7 V	±2.0% rdg.±7 V	DC: 6.0 MΩ±5% AC: 3.0 MΩ±5%
		DC, 45 Hz≤f≤66 Hz	±1.0% rdg.±7 V	±1.5% rdg.±7 V	
		66 Hz<f≤1 kHz	±1.5% rdg.±7 V	-	

Auto range movement threshold: 6000 counts or more for upper range, 540 counts or less for lower range.

* Frequency range of 10 Hz≤f<20 Hz is designed value.

Accuracy Table

AC+DC voltage (PEAK MAX/PEAK MIN)

Range	(Accuracy guarantee range)	Resolution	Accuracy guarantee frequency range* ¹	Measurement accuracy
6.000 V	(0.00 V to ±12.00 V)	0.01 V	10 Hz≤f<45 Hz	±1.5% rdg.±0.07 V
			DC, 45 Hz≤f≤66 Hz	±1.0% rdg.±0.07 V
			66 Hz<f≤1 kHz	±1.5% rdg.±0.07 V
60.00 V	(±3.0 V to ±120.0 V)	0.1 V	10 Hz≤f<45 Hz	±1.5% rdg.±0.7 V
			DC, 45 Hz≤f≤66 Hz	±1.0% rdg.±0.7 V
			66 Hz<f≤1 kHz	±1.5% rdg.±0.7 V
600.0 V* ²	(±30 V to ±1000 V)	1 V	10 Hz≤f<45 Hz	±1.5% rdg.±7 V
			DC, 45 Hz≤f≤66 Hz	±1.0% rdg.±7 V
			66 Hz<f≤1 kHz	±1.5% rdg.±7 V
1000 V* ³	(±50 V to ±1000 V)	1 V	10 Hz≤f<45 Hz	±1.5% rdg.±7 V
			DC, 45 Hz≤f≤66 Hz	±1.0% rdg.±7 V
			66 Hz<f≤1 kHz	±1.5% rdg.±7 V

*1 Frequency range of 10 Hz≤f<20 Hz is designed value.

*2 Values of up to ±1200 V are displayed, but accuracy is not defined for display values in excess of 1000 V (which are provided as reference values).

*3 Values of up to ±1700 V are displayed, but accuracy is not defined for display values in excess of 1000 V (which are provided as reference values).

Accuracy Table

12 Frequency (same for all models)

Frequency is displayed at the same time as the AC current/AC voltage (the frequency is shown on the sub-display when performing ACA/ACV detection with the auto A/auto V function or when using the ACA/ACV function, and on the main display when using the Hz function).

Only auto-range operation is available when performing frequency measurement using the ACA/ACV function (the **RANGE** key is used to switch the current/voltage range).

Minimum detectable current/voltage:

AC voltage 10% of each range's f.s. value

AC current 20.00 A range 4.00 A or more (CM4371, CM4372)

600.0 A range 20.0 A or more (CM4371, CM4372)

600.0 A range 40.0 A or more (CM4373, CM4374)

2000 A range 200 A or more (CM4373, CM4374)

In the following circumstances, the instrument will display [----Hz] as the value is outside the measurement range:

- Less than 1 Hz.
- If the AC current or AC voltage is less than the minimum detectable current or voltage or outside the input range.
- If there is a superposed DC component when performing ACA/ACV detection with the auto A/auto V function.

Accuracy Table

Frequency (Measurement value/MAX/MIN/AVG)

Range	(Accuracy guarantee range)	Resolution	Measurement accuracy
9.999 Hz	(1.000 Hz to 9.999 Hz)	0.001 Hz	±0.1% rdg.±0.003 Hz
99.99 Hz	(1.00 Hz to 99.99 Hz)	0.01 Hz	±0.1% rdg.±0.01 Hz
999.9 Hz	(1.0 Hz to 999.9 Hz)	0.1 Hz	±0.1% rdg.±0.1 Hz

Auto range movement threshold: 9999 counts or more for upper range, 900 counts or less for lower range.

13 Continuity check (same for all models)

Continuity on threshold: 25 Ω±10 Ω (continuous buzzer sound, red warning backlight lights up)
 Continuity off threshold: 245 Ω±10 Ω
 Conditions of guaranteed accuracy: After zero adjustment has been performed
 Response time: Detection of open or short for 0.5 ms or more
 Overload protection: Lower of 1700 V/1000 V AC or 2×10⁷ V · Hz (energized for 1 minute)
 Overload current: 30 mA or less at steady state, 1.5 A or less at transient state

Range	(Accuracy guarantee range)	Resolution	Measurement current	Measurement accuracy	Open terminal voltage
600.0 Ω	(0.0 Ω to 600.0 Ω)	0.1 Ω	200 μA±20%	±0.7% rdg.±0.5 Ω	2.0 V DC or less

Accuracy Table

14 Resistance measurement (same for all models)

Maximum capacity load: 10 mF
 Maximum inductive load: 10 H
 Conditions of guaranteed accuracy: After zero adjustment has been performed
 Overload protection: Lower of 1700 V DC/1000 V AC or 2×10^7 V · Hz (energized for 1 minute)
 Overload current: 30 mA or less at steady state, 1.5 A or less at transient state

Resistance measurement (Measurement value/MAX/MIN/AVG)

Range	(Accuracy guarantee range)	Resolution	Measurement current	Measurement accuracy	Open terminal voltage
600.0 Ω	(0.0 Ω to 600.0 Ω)	0.1 Ω	200 μA±20%	±0.7% rdg.±0.5 Ω	2.0 V DC or less
6.000 kΩ	(0.000 kΩ to 6.000 kΩ)	0.001 kΩ	100 μA±20%	±0.7% rdg.±0.005 kΩ	2.0 V DC or less
60.00 kΩ	(0.00 kΩ to 60.00 kΩ)	0.01 kΩ	10 μA±20%	±0.7% rdg.±0.05 kΩ	2.0 V DC or less
600.0 kΩ	(0.0 kΩ to 600.0 kΩ)	0.1 kΩ	1 μA±20%	±0.7% rdg.±0.5 kΩ	2.0 V DC or less

Auto range movement threshold: 6000 counts or more for upper range, 540 counts or less for lower range.

15 Diode (same for all models)

Overload protection: Lower of 1700 V DC/1000 V AC or 2×10^7 V • Hz (energized for 1 minute)
 Overload current: 30 mA or less at steady state, 1.5 A or less at transient state

Range	(Accuracy guarantee range)	Resolution	Short-circuit current	Measurement accuracy	Open terminal voltage
1.800 V	(0.000 V to 1.800 V)	0.001 V	200 μ A \pm 20%	\pm 0.7% rdg. \pm 0.005 V	2.0 V DC or less

Beeping buzzer tone at forward connection (0.15 V to 1.8 V).
 Continuous buzzer tone and red backlight lights up if less than 0.15 V.

16 Electrostatic capacity (same for all models)

Overload protection: Lower of 1700 V DC/1000 V AC or 2×10^7 V • Hz (energized for 1 minute)
 Overload current: 30 mA or less at steady state, 1.5 A or less at transient state

Accuracy Table

Electrostatic capacity (Measurement value/MAX/MIN/AVG)

Range	(Accuracy guarantee range)	Resolution	Discharge current	Measurement accuracy	Open terminal voltage
1.000 μF	(0.000 μF to 1.100 μF)	0.001 μF	10 n/100 n/1 $\mu\text{A}\pm 20\%$	$\pm 1.9\%$ rdg. ± 0.005 μF	2.0 V DC or less
10.00 μF	(0.00 μF to 11.00 μF)	0.01 μF	100 n/1 $\mu/10$ $\mu\text{A}\pm 20\%$	$\pm 1.9\%$ rdg. ± 0.05 μF	2.0 V DC or less
100.0 μF	(0.0 μF to 110.0 μF)	0.1 μF	1 $\mu/10$ $\mu/100$ $\mu\text{A}\pm 20\%$	$\pm 1.9\%$ rdg. ± 0.5 μF	2.0 V DC or less
1000 μF	(0 μF to 1100 μF)	1 μF	10 $\mu/100$ $\mu/200$ $\mu\text{A}\pm 20\%$	$\pm 1.9\%$ rdg. ± 5 μF	2.0 V DC or less

Auto range movement threshold: 1100 counts or more for upper range, 100 counts or less for lower range.

17 Temperature (same for all models)

Thermocouple:	Use the DT4910 Thermocouples (K). Accuracy figures do not include the DT4910 Thermocouples (K) error component. [DT4910 error: $\pm 2.5^\circ\text{C}$ (Class 2)]
Instrument reference contact temperature correction stabilization time:	120 minutes (when ambient temperature is varied abruptly from 60°C to 23°C)
Overload protection:	Lower of 1700 V DC/1000 V AC or 2×10^7 V \cdot Hz (energized for 1 minute)
Overload current:	30 mA or less at steady state, 1.5 A or less at transient state

Accuracy Table

Temperature (Measurement value/MAX/MIN/AVG)

Thermocouple type	Range	Resolution	Accuracy* ¹
K	-40.0°C to 400.0°C	0.1°C	±0.5% rdg. ±3.0°C
	-40°F to 752°F* ²	0.1°F	±0.5% rdg. ±5.4°F

*1: In an environment where the temperature of the instrument is ±1°C and stable, the accuracy is specified.

*2: Instrument can be made to display readings in Fahrenheit (°F) by means of special operation.

18 Electric charge detection

During voltage detection, a continuous buzzer sounds and the red warning backlight lights up.

Range (detection sensitivity)	Detection voltage range*	Detection target frequency
Hi	40 V AC to 600 V AC	50 Hz/60 Hz
Lo	80 V AC to 600 V AC	50 Hz/60 Hz

* In contact with the insulated wire that is equivalent to IV2 mm².

Accuracy Table

19 DC power 600.0 A (CM4371, CM4372)

Displays the product of DC current and DC voltage.

Accuracy guarantee conditions, zero-display range, connection method, and band depend on the DC current and DC voltage.

Display range switching*	Minimum resolution	Measurement accuracy
0.0 VA to 1020 kVA	0.1 VA	$\pm 2.0\%$ rdg. ± 20 dgt.

* Switches the display range automatically based on the voltage range.

20 DC power 2000 A (CM4373, CM4374)

Displays the product of DC current and DC voltage.

Accuracy guarantee conditions, zero-display range, connection method, and band depend on the DC current and DC voltage.

Display range switching*	Minimum resolution	Measurement accuracy
0.000 kVA to 3400 kVA	1 VA	$\pm 2.0\%$ rdg. ± 20 dgt.

* Switches the display range automatically based on the voltage range.

Warranty Certificate HIOKI

Model	Serial No.	Warranty period Three (3) years from date of purchase (_ / _ / _)	<p>This product passed a rigorous inspection process at HioKI before being shipped.</p> <p>In the unlikely event that you experience an issue during use, please contact the distributor from which you purchased the product, which will be repaired free of charge subject to the provisions of this Warranty Certificate. This warranty is valid for a period of three (3) years from the date of purchase. If the date of purchase is unknown, the warranty is considered valid for a period of three (3) years from the product's date of manufacture. Please present this Warranty Certificate when contacting the distributor. Accuracy is guaranteed for the duration of the separately indicated guaranteed accuracy period.</p> <p>1. Malfunctions occurring during the warranty period under conditions of normal use in conformity with the Instruction Manual, product labeling (including stamped markings), and other precautionary information will be repaired free of charge, up to the original purchase price. HioKI reserves the right to decline to offer repair, calibration, and other services for reasons that include, but are not limited to, passage of time since the product's manufacture, discontinuation of production of parts, or unforeseen circumstances.</p> <p>2. Malfunctions that are determined by HioKI to have occurred under one or more of the following conditions are considered to be outside the scope of warranty coverage, even if the event in question occurs during the warranty period:</p> <ol style="list-style-type: none"> a. Damage to objects under measurement or other secondary or tertiary damage caused by use of the product or its measurement results b. Malfunctions caused by improper handling or use of the product in a manner that does not conform with the provisions of the Instruction Manual c. Malfunctions or damage caused by repair, adjustment, or modification of the product by a company, organization, or individual not approved by HioKI d. Consumption of product parts, including as described in the Instruction Manual e. Malfunctions or damage caused by transport, dropping, or other handling of the product after purchase f. Changes in the product's appearance (scratches on its enclosure, etc.) g. Malfunctions or damage caused by fire, wind or flood damage, earthquakes, lightning, power supply anomalies (including voltage, frequency, etc.), war or civil disturbances, radioactive contamination, or other acts of God h. Damage caused by connecting the product to a network i. Failure to present this Warranty Certificate j. Failure to notify HioKI in advance if used in special embedded applications (space equipment, aviation equipment, nuclear power equipment, life-critical medical equipment or vehicle control equipment, etc.) k. Other malfunctions for which HioKI is not deemed to be responsible <p>*Requests</p> <ul style="list-style-type: none"> • HioKI is not able to reissue this Warranty Certificate, so please store it carefully. • Please fill in the model, serial number, and date of purchase on this form.
			16-01 EN

- Please visit our website for the following:
 - Regional contact information
 - The latest revisions of instruction manuals and manuals in other languages.
 - Declarations of Conformity for instruments that comply with CE mark requirements.
- All reasonable care has been taken in the production of this manual, but if you find any points which are unclear or in error, please contact your supplier or the International Sales and Marketing Department at Hioki headquarters.
- In the interests of product development, the contents of this manual are subject to revision without prior notice.
- The content of this manual is protected by copyright.
No reproduction, duplication or modification of the content is permitted without the authorization of HIOKI E.E.CORPORATION.

HIOKI

1704EN

Edited and published by HIOKI E.E.CORPORATION

Printed in Japan