

CM4002

CM4003

AC LEAKAGE CLAMP METER

HIOKI

Instruction Manual



Read carefully before use.

Keep for future reference.





EN

July 2025 Revised edition 4
CM4002A961-04

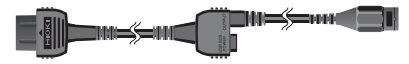

600602654

Checking Package Contents

Main body	Accessories
<input type="checkbox"/> AC Leakage Clamp Meter CM4002 CM4003 (equipped with output function) 	<input type="checkbox"/> LR6 Alkaline batteries x2  <input type="checkbox"/> C0203 Carrying Case  <input type="checkbox"/> Instruction Manual (this manual) Please visit Hioki's website to check for versions in other language. (p. 1) <input type="checkbox"/> Operating Precautions (0990A907)
	Accessories [CM4003] <input type="checkbox"/> L9097 Connection Cable (approx. 1.5 m)  <input type="checkbox"/> L9510 USB Cable (Type-A to Type-C, 1.0 m) 

CM4002A961-04

i

Details of Intended Operations

Setting the range	▶ p. 18
Installing the batteries and Z3210 Wireless Adapter	▶ p. 23, p. 28
Performing long-duration measurement using an external power supply CM4003	▶ p. 29
Locating an insulation failure (identifying GFCI and RCD trip events)	▶ p. 36
Reducing the effects of noise (filter function)	▶ p. 39
Freezing the readouts to take readings (hold function)	▶ p. 41
Viewing the maximum, minimum, average, and peak values of the measured data	▶ p. 44
Receiving an alarm if a measured value exceeds the threshold value (comparator function)	▶ p. 46
Checking for intermittent leakage	
• Using the output function to perform monitoring with a recorder CM4003	▶ p. 49
• Using the GENNECT Cross app to perform monitoring (event recording function)	p. 60
Using the wireless communications (GENNECT Cross, HID function)	▶ p. 56

Contents

Checking Package Contents	i
Details of Intended Operations	ii
Introduction.....	1
Overview	3
Principle of leakage current measurement.....	4
Notations	5
Options	8
Safety Information	9
Operating Precautions.....	13
Part Names.....	16
Operation Keys.....	18
Display Panel.....	20

1

2

3

4

iii

Index

Contents

1	Preparing for Measurement	23
1.1	Installing Batteries and the Z3210 Wireless Adapter	23
	Installation/replacement procedure	28
1.2	Using an External Power Supply CM4003	29
1.3	Inspection Prior to Measurement	30
2	Performing Measurement	31
2.1	Measuring Leakage Current.....	31
	Measurement procedure	32
	Locating an insulation failure (identifying GFCI and RCD trip events)	36
	Precautions for measuring the load current	38
2.2	Filter Function (FILTER).....	39
2.3	Hold Function (HOLD).....	41
2.4	Max., Min., Average, and Peak Values (MAX/MIN).....	44
2.5	Inrush Current Measurement (AC INRUSH)	45
2.6	Comparator Function (COMP)	46
2.7	Simple event recording function.....	47

2.8	Output function (OUTPUT) CM4003	49
	Output rate (A-to-V conversion ratio)	50
	Setting the output function (RMS/WAVE)	51
2.9	Auto-Power Save Function (APS)	53
2.10	Backlight.....	54
	Display backlight	54
	Warning backlight.....	55
2.11	Wireless Communications Function.....	56
	Using GENNECT Cross	56
	Z3210-to-Excel direct data entry function (Excel direct input function, HID function)	61
2.12	Power Key Combinations.....	65
3	Specifications	67
3.1	General Specifications	67



Contents

3.2	Input, Output, and Measurement Specifications	70
	Accuracy list	74
	Output specifications CM4003	79
3.3	Compatibility with IEC/EN 61557-13	80
4	Maintenance and Service	81
	Calibration	81
	Cleaning	82
	Disposing of the Instrument	82
4.1	Troubleshooting.....	83
	Before sending the instrument to be repaired	83
4.2	Error Displays.....	86
	Index	87

Warranty Certificate

Introduction

Thank you for choosing the Hioki CM4002/CM4003 AC Leakage Clamp Meter. To ensure your ability to get the most out of this instrument over the long term, please read this manual carefully and keep it available for future reference.

Carefully read the separate document entitled “Operating Precautions” before use.

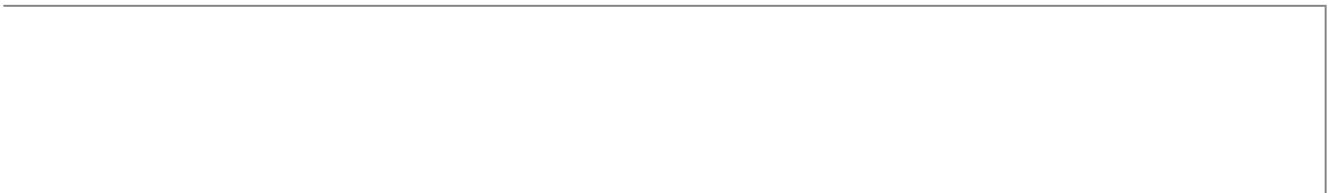

Introduction

Intended audience

This manual has been written for use by individuals who use the product or provide information about how to use the product. In explaining how to use the product, it assumes electrical knowledge (equivalent of the knowledge possessed by a graduate of an electrical program at a technical high school).

Trademarks

- Excel is a trademark of the Microsoft group of companies.
- The Bluetooth® word mark and logos are registered trademarks owned by Bluetooth SIG, Inc. and any use of such marks by Hioki E.E. Corporation is under license. Other trademarks and trade names are those of their respective owners.

Overview

This AC leakage clamp meter allows you to measure from minute leakage current to load current.

■ Accurately measuring minute leakage current

- The 6.000 mA range is incorporated to ensure the measurement with a high resolution of 1 μ A.
- High permeability magnetic material is used for the jaws.
Effects of external electromagnetic noise are minimized to enable the measurement with high reproducibility.

■ Measuring a wide range of current from leakage current to load current

- Accuracy ranging from 0.060 mA to 200.0 A is ensured.
- Frequency band ranging from 15 Hz to 2 kHz

For more information about leak current measurement, please visit the GENNECT website.

Introduction

Principle of leakage current measurement



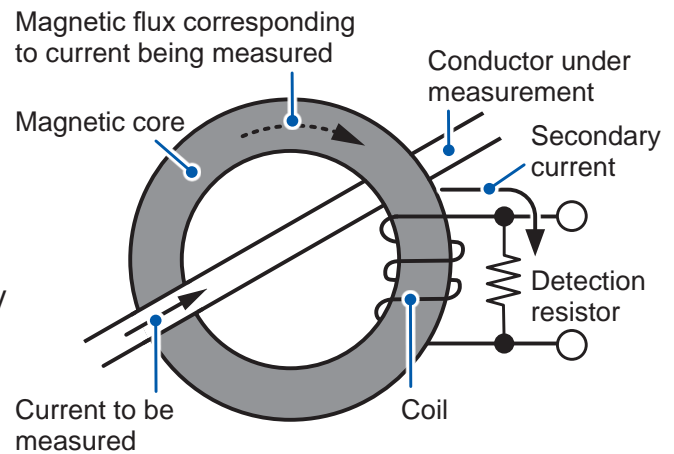



The instrument is designed based on the principle of electromagnetic induction. The magnetic flux corresponding to the current flowing through the conductor to be measured is detected by a current transformer that consists of a magnetic core and coil. The current transformer generates the current corresponding to the magnetic field (secondary current). The detection resistor converts this secondary current into the voltage to calculate the value of the current flowing through the conductor.



Notations





Safety notations

In this document, the severity levels of risk and hazard are classified as follows.



 DANGER	<p>Indicates an imminently hazardous situation that, if not avoided, will result in death or serious injury.</p>		<p>Indicates a high-voltage hazard. Failure to verify safety or improper handling of the instrument could lead to an electric shock, burn, or death.</p>
 WARNING	<p>Indicates a potentially hazardous situation that, if not avoided, could result in death or serious injury.</p>	IMPORTANT	<p>Indicates information or content that is particularly important from the stand point of operating or maintaining the instrument.</p>
 CAUTION	<p>Indicates a potentially hazardous situation that, if not avoided, could result in minor or moderate injury or potential risks of damage to the supported product (or to other property).</p>		<p>Indicates an action that must not be performed.</p>
			<p>Indicates an action that must be performed.</p>

Notations

Symbols shown on the instrument

	Indicates the need for caution or the presence of danger. For more information about locations where this symbol appears on instrument components, see the “Operating Precautions” (p. 13), warning messages listed at the beginning of operating instructions, and the accompanying document entitled “Operating Precautions.”
	Indicates AC (Alternating Current).
	Indicates that the instrument may be connected to or disconnected from a live conductor.
	Indicates an instrument that has been protected throughout by double insulation or reinforced insulation.
	Indicates the limit value of an external magnetic field specified by IEC/EN61557-13 Class 2. The use of the instrument in an external magnetic field of exceeding 30 A/m is outside a range of IEC/EN 61557-13 Class 2.

Symbols for various standards

	Indicates the Waste Electrical and Electronic Equipment Directive (WEEE Directive) in EU member states.
	Indicates that the product conforms to regulations required by the EU Directive.

Screen display

The instrument screen displays the alphanumeric characters as follows.

A	B	C	D	E	F	G	H	I	J	K	L	M	N	O	P	Q	R	S	T	U	V	W	X	Y	Z
A	b	C	d	E	F	G	H	I	J	K	L	ñ	o	P	q	r	S	t	U	v	Y	1	4	≡	

1	2	3	4	5	6	7	8	9	0
1	2	3	4	5	6	7	8	9	0

Accuracy labeling

Hioki expresses accuracy as error limit values specified in terms of percentages of reading and of full scale.

Reading (display value)	Indicates the value displayed by the instrument. Limit values for reading errors are expressed as a percentage of the reading (“% of reading” or “% rdg”).
Full scale (maximum display value)	Indicates the maximum display value for each measurement range. Measurement range values for the instrument indicates that maximum display value. Limit values for full-scale errors are expressed as a percentage of full scale (“% of full scale” or “% f.s.”).

Options

Other notations

Tips	Indicates useful advice concerning instrument performance and operation.
CM4003	Indicates that the item is applicable to the CM4003 only.
APS (bold)	The names of elements on the screen are printed in bold.
(p.)	Indicates the page number to reference.
*	Instructs the reader to see below for additional information.

Options

The options listed below are available for the instrument. To order an option, please contact your authorized Hioki distributor or reseller. Options are subject to change. Check Hioki's website for the latest information.

Z3210 Wireless Adapter		C0203 Carrying Case	
		L9097 Connection Cable (Approx. 1.5 m)	
		CM4003	
9704 Conversion Adapter (BNC-to-banana plug) CAT III 600 V, CAT II 1000 V		Z1013 AC Adapter (power cord included)	
CM4003		CM4003	

Safety Information

This instrument is designed to conform to IEC 61010 Safety Standards and has been thoroughly tested for safety prior to shipment. However, using the instrument in a way not described in this manual may negate the provided safety features.

Carefully read the following safety notes before using the instrument.

DANGER

- **Familiarize yourself with the instructions and precautions in this manual before use.**



Failure to do so could cause improper use of the instrument, resulting in serious bodily injury or damage to the instrument.

Safety Information

WARNING

-  ■ **Do not attempt to modify, disassemble, or try to repair the instrument.**

Doing so could cause serious bodily injury or fire.



- **If you have not used any electrical measuring instruments before, you should be supervised by a technician who has experience in electrical measurement.**

Failure to do so could cause the operator to experience an electric shock. Moreover, it could cause serious events such as heat generation, fire, and an arc flash due to a short-circuit.

Protective gear

WARNING

- **Use appropriate protective insulation.**



Performing measurement using this instrument involves live-line work. Failure to use protective gear could cause the operator to experience an electric shock. Using protective gear is prescribed under applicable laws and regulations.

Measurement categories

To ensure safe operation of measuring instruments, IEC 61010 specifies the measurement categories, which classifies testing and measuring circuits into three categories according to the types of mains circuits to which they are intended to be connected.

DANGER

- **Do not use a measuring instrument for measurements on a mains circuit that exceeds the range of the measurement category rated for the instrument.**



- **Do not use a measuring instrument without a measurement category rating for measurements on a mains circuit.**

Failure to observe this can cause a serious bodily injury and damage to the instrument and other equipment.

The CM4002 conforms to the safety requirements for CAT IV (300 V) and CAT III (600 V) measuring instruments.

The CM4003 conforms to the safety requirements for CAT III (300 V) measuring instruments.

Safety Information

Measurement category II (CAT II)

Applicable to test and measuring circuits connected directly to utilization points (socket outlets and similar points) of the low-voltage mains installation.

EXAMPLE: Measurements on household appliances, portable tools, and similar equipment, and on the consumer side only of socket-outlets in the fixed installation.

Measurement category III (CAT III)

Applicable to test and measuring circuits connected to the distribution part of the building's low-voltage mains installation.

EXAMPLE: Measurements on distribution boards (including secondary meters), photo voltaic panels, circuit breakers, wiring, including cables, bus-bars, junction boxes, switches, socket-outlets in the fixed installation, and equipment for industrial use and some other equipment such as stationary motors with permanent connection to the fixed installation.

Measurement category IV (CAT IV)

Applicable to test and measuring circuits connected at the source of the building's low-voltage mains installation.

EXAMPLE: Measurements on devices installed before the main fuse or circuit breaker in the building installation.

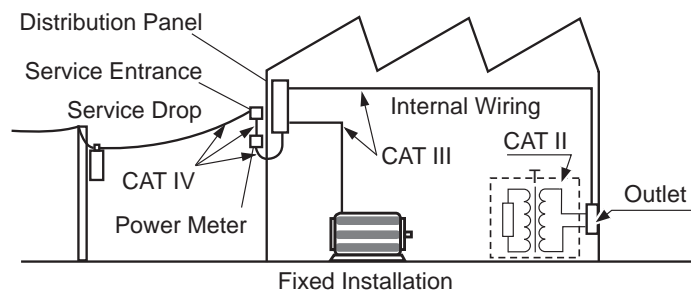

Operating Precautions

Observe the following precautionary information to ensure that the instrument can be used safely and in a manner that allows it to perform as described in its specifications. Carefully read the separate document entitled “Operating Precautions” before use. Use of the instrument should conform not only to its specifications, but also to the specifications of all accessories, options, and other equipment in use.

Handling the instrument

DANGER

- **Do not use the instrument to measure circuits that exceed its ratings or specifications.**

Doing so could cause damage to the instrument or overheating, resulting in serious bodily injury.



- **Do not measure any current in excess of the maximum input current.**

Doing so can cause overheating of the sensor, resulting in bodily injury, fire, or damage to the instrument.

The instrument has a maximum input current of 200 A with a frequency of between 40 Hz and 600 Hz. If a current has another frequency, its value the instrument can measure is limited. See “Frequency derating characteristics” (p. 71) about current values.

Operating Precautions

WARNING

-  ■ **Do not approach high-voltage equipment or wiring when performing measurement using a transformer's ground wire.**

Failure to do so could cause the operator to experience an electric shock.

-  ■ **When the ground wire is close to a high voltage live part, reroute the ground wire before measurement.**

Failure to do so could cause the operator to experience an electric shock.

CAUTION

-  ■ **Do not bend or pull on cables at temperatures of 0°C or lower.**
The cable is hardened. Doing so could damage the insulation or cause a wire break, resulting in an electric shock.

-  ■ **Keep the jaws closed when the instrument is not in use.**
Leaving the jaws open will cause dust or dirt to settle on the facing core surfaces, resulting in damage to the instrument.

IMPORTANT



- Do not allow any foreign object to be caught between the facing core surfaces of the jaws.
 - Do not scratch the facing core surfaces of the jaws.
 - Do not touch the facing core surfaces of the jaws with your fingers.
 - Do not insert any foreign object into the gap of the jaws.
 - Do not drop the instrument.
 - Do not subject the instrument to any shock.
- Doing so may adversely affect the measurement accuracy and open/close operation.

- Electric circuit on which DC components are superimposed may not be measured accurately.
- Displayed values can frequently fluctuate due to induction potential even when no voltage is applied. This, however, is not a malfunction.
- When the  mark blinks, replace the batteries with new ones. The batteries are exhausted. (p.28)

Part Names

Part Names















(The illustration shows the CM4003.)

1	Lever
2	Power key (p. 18)
3	Jaws (p. 15)
4	Barrier
5	Serial number For the latest information, check Hioki's website. Do not remove this sticker because the number is required for product tracking.
6	Operation keys (p. 18)
7	Display panel (p.20)
8	Battery cover (p.28)
9	Cable connection terminal CM4003 (p.29, p.49)

Operation Keys

Operation Keys

Key	Press. 	Hold down for 1 s or longer. 
	Turns on the instrument. (p. 32, p. 65)	Turns off the instrument.
 HOLD AUTO HOLD	Freezes the readouts. / Disables the hold function. (p. 41)	Automatically freezes the readouts. / Disables the auto-hold function. (p. 41)
	Sets or switches the maximum, minimum, average, and peak values. (p. 44)	Resets the maximum, minimum, average, and peak value display.
 RANGE FILTER	Cycles through the range. 	Toggles the filter on or off. (p. 39) (The setting is not saved to the instrument.)
 COMP EVENT	Toggles the comparator function on or off. (p. 46)	Displays the number of events recorded by the event recording function. (p. 60)

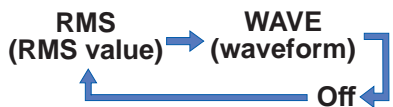
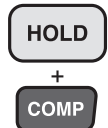
Key	Press. 	Hold down for 1 s or longer. 
	-	Toggles the inrush current measurement (AC INRUSH) on or off. (p.45)
	Toggles the display backlight on or off. (p.54)	Switches the output function (OUTPUT). CM4003 (p.49) 
	-	Toggles the wireless communications function on or off. (The setting is saved to the instrument. Available only when the Z3210 is installed) (p.56)

Display Panel

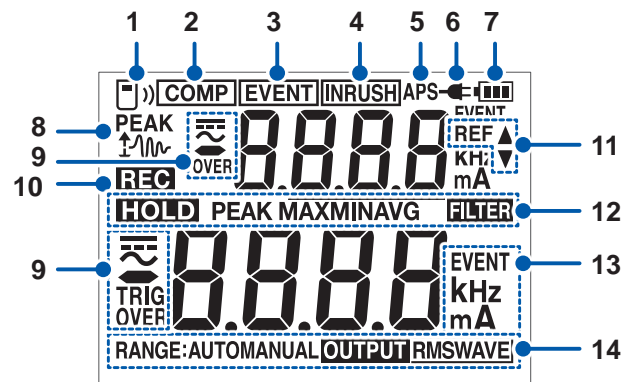
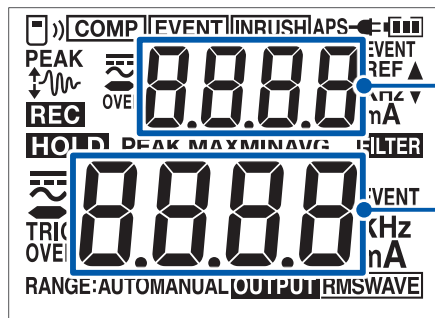

Display Panel

Dual readouts



1		Wireless communications function	p.56
2	COMP	Comparator	p.46
3	EVENT	Simple event recording Event recording	p.47 p.60
4	INRUSH	Inrush current measurement (AC INRUSH)	p.45
5	APS	Automatic power save	p.53
6		External power supply CM4003	p.29
7		Remaining battery power	p.23

20

8		Peak value of AC inrush current	p.45
9		AC measurement	-
	TRIG	Event occurrence	-
	OVER	Overload alarm	p.55
10	REC	Recording an event.	-
11	REF 	Comparator threshold value	p.46
12	HOLD	Freezing the readouts.	p.41
	MAX, MIN, AVG	Maximum, minimum, average values	p.44
	PEAK MAX, PEAK MIN	Highest of peak value, lowest of peak value	
	FILTER	Filter function	p.39
13	EVENT, kHz, mA	Measurement unit (same applies to sub-readout)	-
14	RANGE:AUTO	Automatic ranging	p.18
	RANGE: MANUAL	Manual ranging	
	OUTPUT RMS	RMS value output CM4003	p.49
	OUTPUT WAVE	Waveform output CM4003	

Display Panel





1

Preparing for Measurement

1.1 Installing Batteries and the Z3210 Wireless Adapter

1

When using the instrument for the first time, install two LR6 Alkaline batteries or two fully charged HR6 Nickel-metal hydride batteries. (p.28) In addition, check that there is adequate remaining power in the batteries before starting the measurement.

	Appears	There is adequate remaining battery power.
	Appears	As the remaining power decreases, the indicators disappear from the left.
	Appears	The batteries are exhausted. Replace the batteries in good time.
	Blinks	The batteries are exhausted. Replace the batteries with new ones.



The CM4003 can be used by connecting an external power supply without installing the batteries. (p.29)

When the Z3210 Wireless Adapter (option) is installed, the wireless communications function can be used. (p.56)

 **WARNING**

- Do not short-circuit the battery.
- Do not disassemble the battery.
-  ■ Do not heat the battery up.
- Do not throw the battery into a fire.
- Do not charge alkaline batteries.

Doing so can cause the battery to explode, resulting in bodily injury.

-
- **Before removing the battery cover, remove the instrument from an object under measurement and turn off it.**



Failure to do so could cause the operator to experience an electric shock. When the instrument is clamped around the object under measurement, the battery contacts are regarded as high-voltage parts.

 **WARNING**

- **After replacing the batteries or installing/removing the Z3210 Wireless Adapter, install the battery cover and tighten the screw.**

Use of the instrument with the battery cover removed could result in serious bodily injury.



Besides, if the screw of the battery cover is not tightened, the cover will not be secured.

- **Secure the battery cover with the screw attached to the instrument at the time of shipment.**

If the battery cover is secured with another screw, the instrument could be damaged, resulting in bodily injury. If you have lost the screw or find that the screw is damaged, please contact your authorized Hioki distributor or reseller.

CAUTION

- Do not mix batteries of different ages or types.
- Do not use a battery whose recommended service life has expired.
-  ■ Do not reverse the battery polarity.
- Do not leave the exhausted batteries in the instrument.
Doing so may cause the battery to leak, damaging the instrument.

-
- Use the specified type of batteries only
(LR6 Alkaline batteries or HR6 Nickel-metal hydride batteries).
 - Remove the batteries when the instrument is not in use for an extended period of time.



Failure to do so may cause the battery to leak, damaging the instrument.

-
- Before handling the Z3210, eliminate static electricity on your body by touching any metallic part, such as a doorknob.

Failure to do so may cause static electricity to damage the Z3210.

-
- When the  mark blinks, replace the batteries with new ones. The batteries are exhausted.
 - Before replacing the batteries, turn off the instrument.
 - Handle and dispose of batteries in accordance with local regulations.

Nickel-metal hydride batteries

CAUTION



When using the instrument, insert two LR6 Alkaline batteries or two fully charged HR6 Nickel-metal hydride batteries.

1

The instrument powered by nickel-metal batteries will indicate an inaccurate remaining-battery level; however, it can be used without any trouble even with such batteries inserted. See the continuous operating time below.

- When two LR6 Alkaline batteries are used (reference values at 23°C)
Approx. 48 hours (without the Z3210 installed)
Approx. 30 hours (with the Z3210 installed, in wireless communication)
With the backlight set to off, with no input
- When two HR6 Nickel-metal hydride batteries (1900 mAh capacity each) are used
Approx. 44 hours (without the Z3210 installed)
Approx. 35 hours (with the Z3210 installed, in wireless communication)
With the backlight set to off, with no input

Visit an FAQ page on Hioki's global website for more information about nickel-metal hydride batteries that Hioki has guaranteed to work.

Installing Batteries and the Z3210 Wireless Adapter

Installation/replacement procedure

After reading the safety precautions (p.23), follow the procedure below for installation.

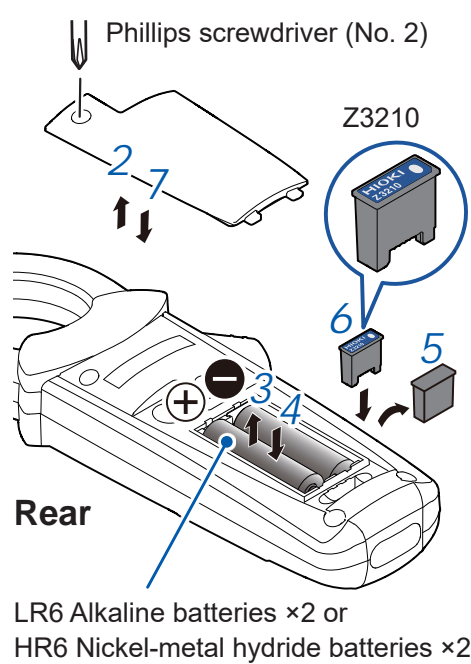

- 1 Remove the instrument from the object under measurement and turn off the instrument.
- 2 Loosen the screw and remove the battery cover.
- 3 Remove the old batteries (when replacing the batteries).
- 4 Install new batteries.
- 5 When installing the Z3210 Wireless Adapter (option), remove the protective cap.
- 6 Carefully checking the orientation, insert the Z3210 all the way inside.
- 7 Install the battery cover and tighten the screw.

See “Using the wireless communications function” (p.57).

1.2 Using an External Power Supply CM4003

1

Use an external power supply for long-term measurement.

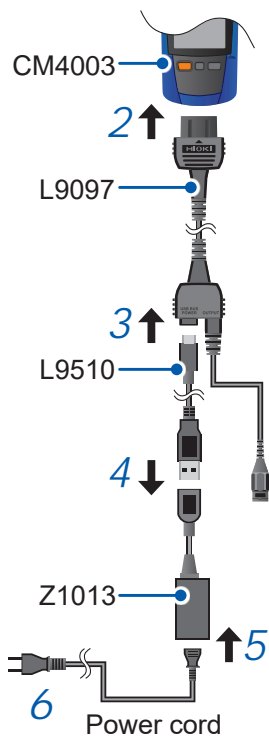





If the supplied power includes significant noise, the display may show several counts or noise may be present in the output. When the power is being supplied externally, the auto-power save function will be disabled.

- 1 Remove the instrument from the object under measurement and turn off the instrument.
- 2 Connect the L9097 Connection Cable (included) to the cable connection terminal of the instrument.
- 3 Connect the L9510 USB Cable (included) to the USB terminal (Type-C) of the L9097.
- 4 Connect the other end of the L9510 USB Cable to the Z1013 AC Adapter (option, power cord included).
- 5 Connect the power cord to the Z1013.
- 6 Connect the power cord to an outlet.

When you turn on the instrument, the  mark will appear.

Inspection Prior to Measurement

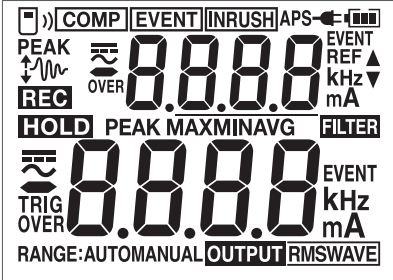
1.3 Inspection Prior to Measurement

Check	Inspection details	Remedy
<input type="checkbox"/>	Check the following points visually. <ul style="list-style-type: none"> • The instrument is not damaged or cracked. • No internal circuit is exposed. 	If the instrument is damaged, ask for repair. Otherwise, the operator may receive an electric shock.
<input type="checkbox"/>	No segments are missing. Pressing the  key while holding down the  key during a power-off condition allows all segments to appear while holding down the  key. 	If any segment is missing, ask for repair.
<input type="checkbox"/>	The  mark does not blink.	When the  mark blinks, replace the batteries with new ones. The batteries are exhausted. (p.23, p.28)

2

Performing Measurement

2.1 Measuring Leakage Current

DANGER

- **Inspect the instrument and verify proper operation before use.**



Use of the instrument while malfunctioning could result in serious bodily injury. If you find any damage, contact your authorized Hioki distributor or reseller. See “1.3 Inspection Prior to Measurement” (p.30).

- **Do not touch the section beyond the barrier during operation.**



Doing so could cause electric shock. See “Part Names” (p. 16).

Measuring Leakage Current

Measurement procedure

1 Turn on the instrument.



The default setting of the range is AUTO.
Change the range as required. (p. 18)

2 Clamp the instrument around the object under measurement.

Wear appropriate protective gear such as gloves.

Clamp the instrument so that the object under measurement is located at the center of the jaws.

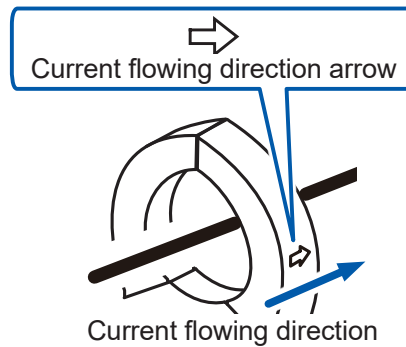

Single-phase 3-wire circuit

- 1. Measurement using ground wire: Clamp around only one wire.
- 2, 3. Measurement of zero-phase current: Clamp around the wires together in a bundle.

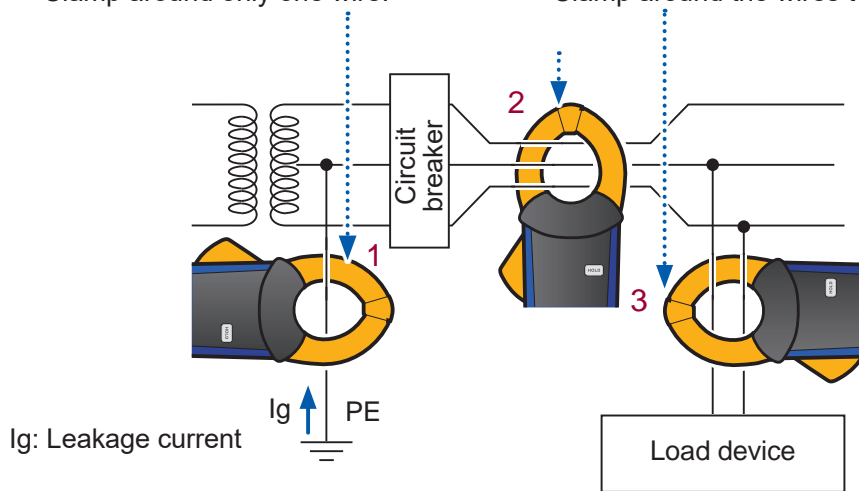

Measuring Leakage Current

Three-phase 3-wire circuit

1, 4. Measurement using ground wire:
Clamp around only one wire.

2, 3. Measurement of zero-phase current:
Clamp around the wires together in a bundle.

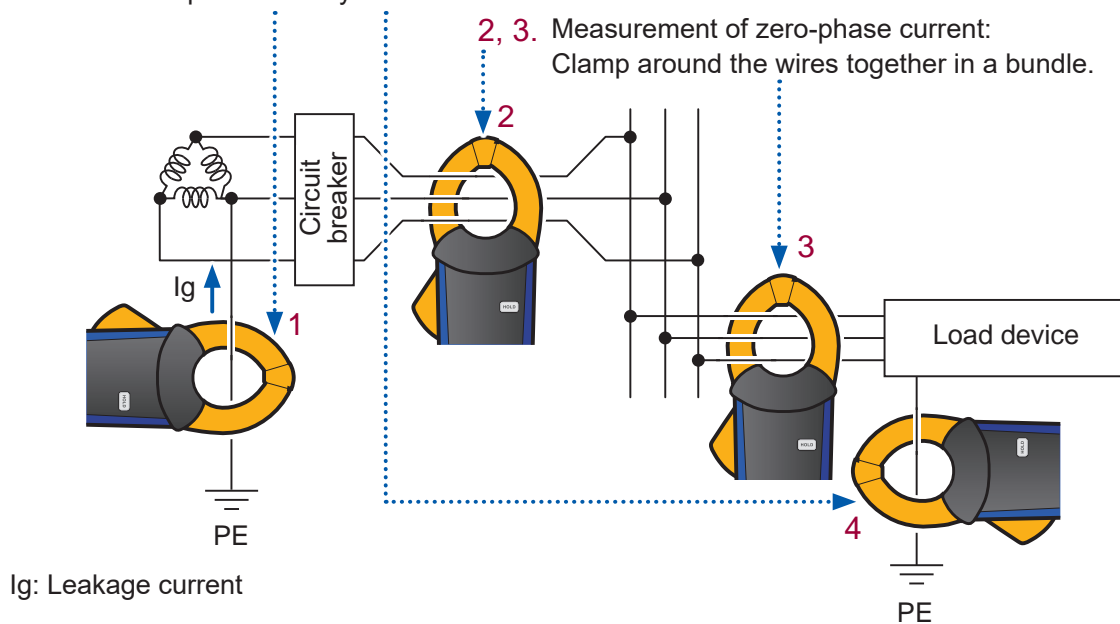

Other circuits

- Clamp around two wires together in a bundle in the single-phase 2-wire circuit.
- Clamp around four wires together in a bundle in the three-phase 4-wire circuit. Even when the instrument cannot be clamped, you can measure leakage current using the ground wire of the equipment instead.

3 Read the current value and frequency.

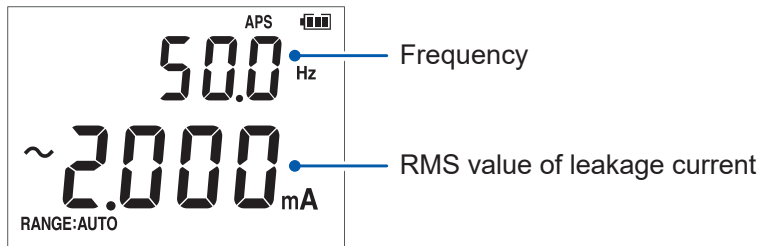

2

IMPORTANT

In the following cases, the accurate measurement may not be performed.

- A large current (around 100 A) flows through adjacent wires.
- Special waveforms, such as that flowing through the secondary side of the inverter, is measured.
- The jaws are not closed completely.

In particular, if the external dimension of the object under measurement is large, such as when the instrument is clamped around three-phase wires together in a bundle, make sure that the jaws are closed completely. If the jaws are even slightly open, errors occur in the measured value and the accuracy cannot be ensured.

- The leakage current measurement at zero phase is affected by the load current. For the degree of influence of the load current, see E12 on p.80.

Measuring Leakage Current

Locating an insulation failure (identifying GFCI and RCD trip events)

By measuring leakage current of the entire circuit using the ground wire of the transformer (location 1 in the figure on the next page), you can determine the presence or absence of an earth leakage in accordance with changes in leakage current.

When you find an earth leakage, perform the bundled measurement of all the wires from the power supply side toward the load side to locate an insulation failure.



To investigate an intermittent earth leakage, such as intermittent ground-fault circuit interrupter (GFCI) and residual-current device (RCD) trip events, the following functions are convenient.

Event recording function (p.60)

When the measured value exceeds the set threshold value, the event data (event occurrence time, event stop time, and maximum value) can be recorded. The Z3210 Wireless Adapter (option) is required.

For details, please visit the GENNECT website.

Output function **CM4003**

You can record the output value with a recorder. (p.49)

Single-phase 3-wire circuit

- If the insulation on the wire has deteriorated at location **A** in the figure, you can detect the leakage current through the measurement by clamping around bundled wires, not at location **3** but location **2**.
- If the insulation on the load device has deteriorated at location **B** in the figure, you can detect the leakage current through the measurement by clamping around the bundled wires, not at location **5** but location **4**.

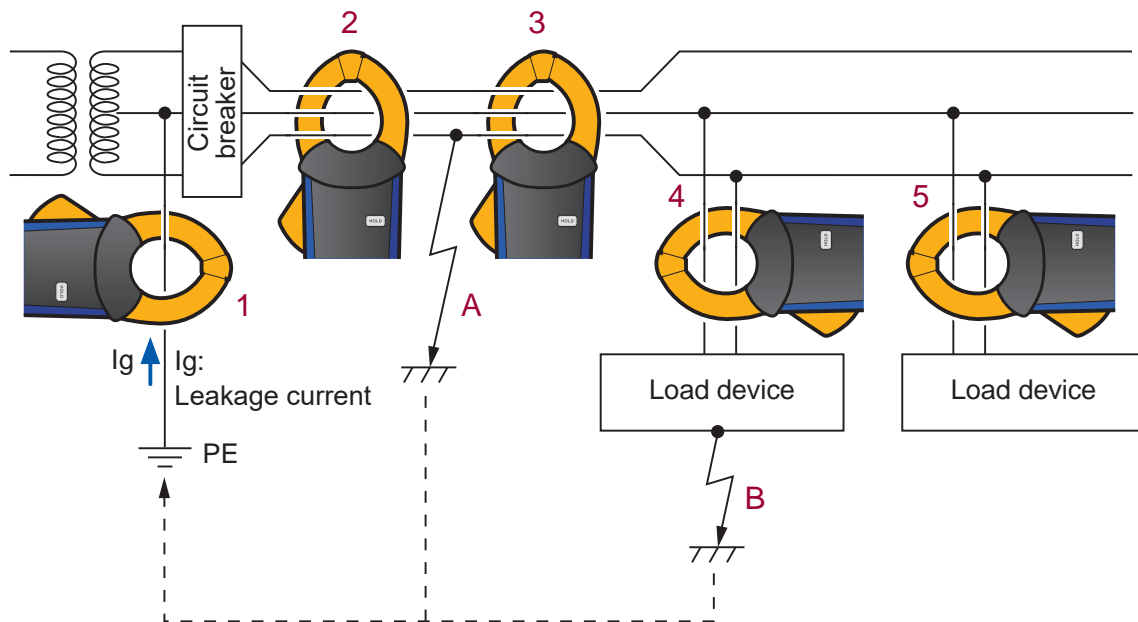

Measuring Leakage Current

Precautions for measuring the load current

IMPORTANT

Be sure to clamp the instrument around only one conductor wire. Regardless of the single-phase and three-phase, when clamping around two or more wires together in a bundle, the load current cannot be measured.

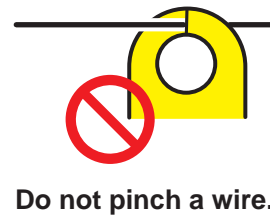
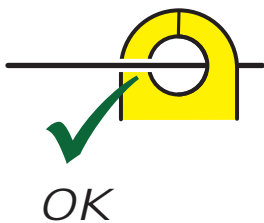

Tips

- Special waveforms, such as that flowing through the secondary side of the inverter, may not be measured.
- In accordance with the magnitude of the input current, a sound may be generated from the jaws due to resonance, but it does not affect the measurement.
- When the magnitude of the input current is unknown, disable the filter function and start the measurement using the auto-range or 200.0 A range.

2.2 Filter Function (FILTER)

When a switching power supply or an inverter is connected to the same system as the object under measurement, high frequency components may be superimposed on the leakage current waveform. Using the filter function can eliminate unnecessary high-frequency components (low-pass filter).

Enable the filter function.



Hold down the key for 1 s or longer.
(Holding down the key for 1 s or longer again disables the function.)

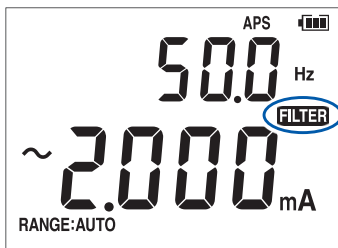

FILTER will appear.

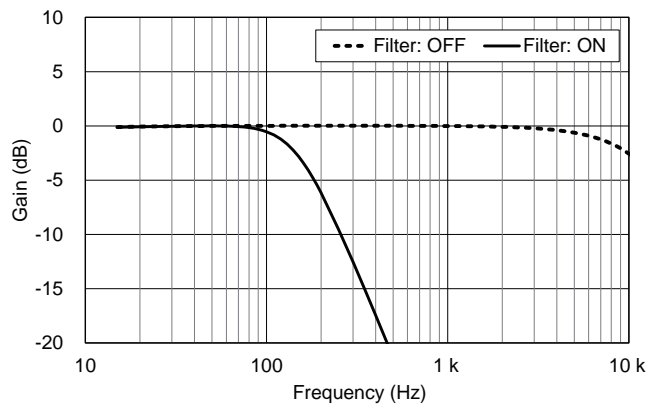

Frequency characteristic example (6 mA range)

2

You can also set the instrument so that the filter function can be enabled or disabled at power-up. (p.65)

39

Filter Function (FILTER)

IMPORTANT

When the filter function is enabled, the instrument may display values lower than actual values.

If the instrument indicates different measured values depending on the range selected manually, trust the one measured using the upper range.



When the filter function is enabled, the frequency band is limited to approx. 180 Hz (-3 dB), which is equivalent to the frequency band of the general earth leakage circuit breaker. To analyze the operation of the earth leakage circuit breaker, it is recommended that you use the filter function.

2.3 Hold Function (HOLD)

Manual hold

The display refresh can be stopped at a desired timing.



Press.
(Pressing the key again can disable the function.)

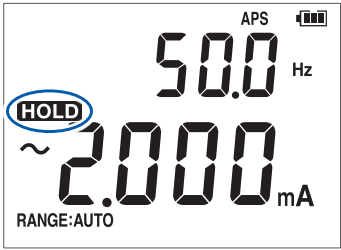

HOLD will appear.
HOLD will be lit.

Automatic hold (AUTO HOLD)

When the measured value is stable, the display refresh will be stopped automatically.



Hold down the key for 1 s or longer.
(Pressing the key again can disable the function.)

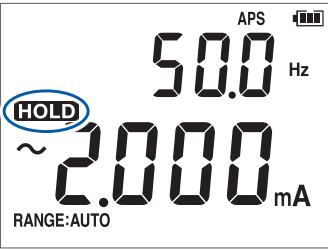

Before auto-hold
HOLD will blink.

After auto-hold
HOLD will appear.
HOLD will be lit.
The buzzer will sound.

Hold Function (HOLD)

Auto-hold conditions

When both the following conditions are satisfied, the instrument will freeze the readouts.

- The measured value does not fluctuate beyond the variation range (see the next page) for a certain period of time.
- The measured value exceeds the threshold value (see the next page).

The instrument continues to freeze the readouts until the auto-hold conditions are satisfied again.

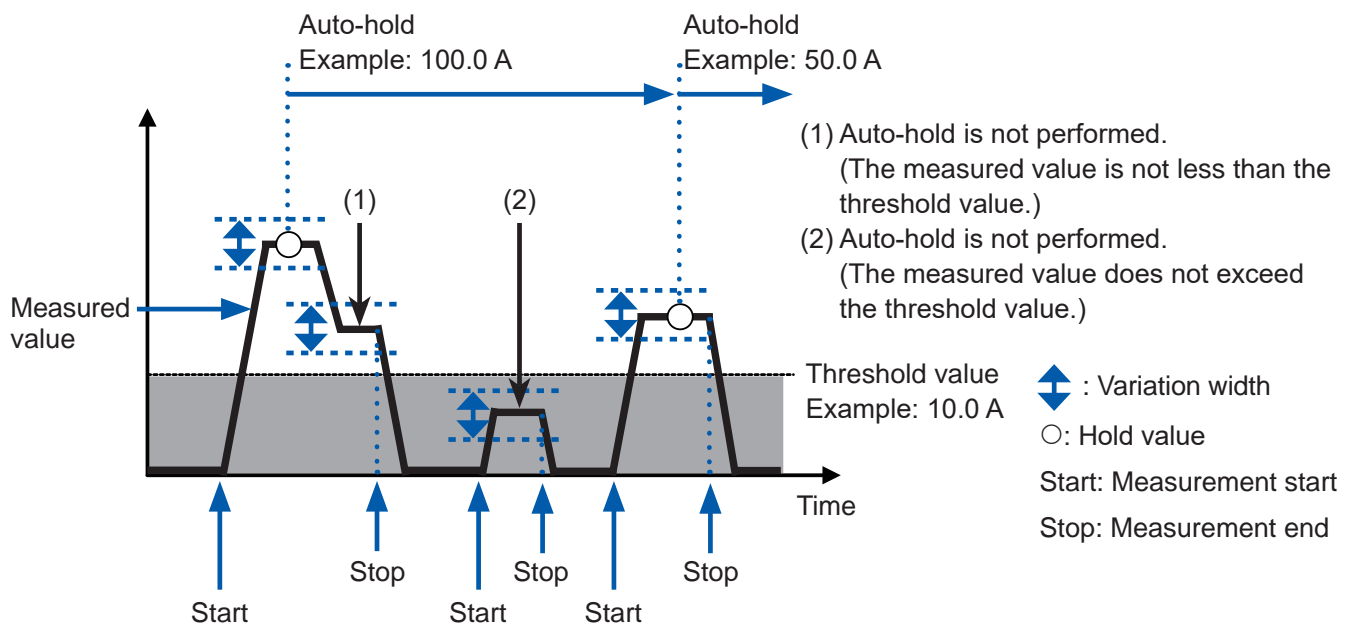

Hold Function (HOLD)

The variation range and threshold value may vary depending on the range.

Range	Variation width	Threshold value
6.000 mA	200 counts or less	300 counts
60.00 mA	100 counts or less	100 counts
600.0 mA		
6.000 A		
60.00 A		
200.0 A		



Max., Min., Average, and Peak Values (MAX/MIN)

2.4 Max., Min., Average, and Peak Values (MAX/MIN)

The maximum, minimum, average, highest peak, or lowest peak values of the measured data can be displayed. The auto-power save function is disabled. (p.53)

1 **Clamp the instrument around the object under measurement.**

2 **Setting the range. (p.18)**

RANGE

If you switch over to MAX or MIN mode while using the auto-range, the range is fixed at the presently set range.

3 **Press the MAX/MIN key to enter MAX/MIN mode and switch the display.**

MAX/MIN

MAX → MIN → AVG → PEAK MAX → PEAK MIN

MAX/MIN



Hold down the key for 1 s or longer. → Cancel

4

HOLD

→ Freezes the readouts.

Main readout:

Maximum, minimum, average, highest peak value, or lowest peak value

Sub-readout:

Present measured value

The instrument measures the RMS value.

“AVG” means the average value of all measured values.

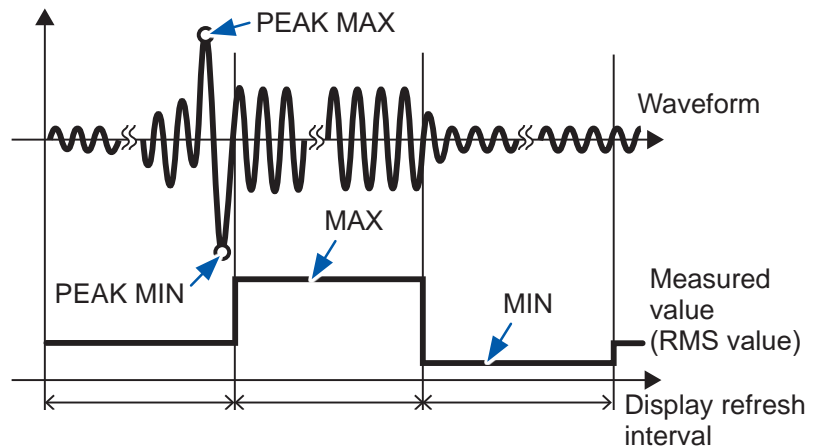

44

2.5 Inrush Current Measurement (AC INRUSH)

The AC inrush current can be measured.

1 Set the range. (p.18)



The inrush measurement range is set as follows in accordance with the range when the current is measured.

Range when the current is measured	INRUSH measurement range
AUTO	200.0 A range
6.000 mA, 60.00 mA	600.0 mA range
600.0 mA, 6.000 A, 60.00 A, 200.0 A	Range when the current is measured

2 Switch over to AC INRUSH mode.



Hold down the key for 1 s or longer.

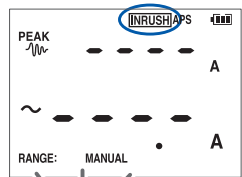
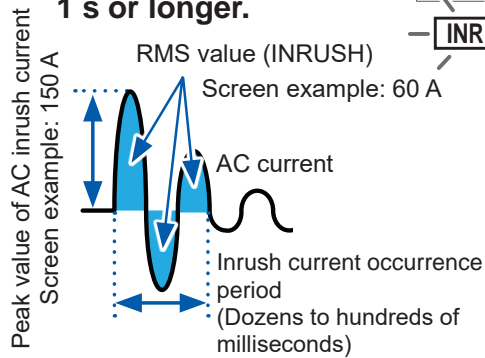

(Inrush current occurs.)

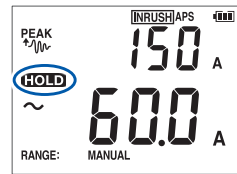

Auto-hold of measured value

INRUSH will blink.

How to exit AC INRUSH mode

Hold down the key for 1 s or longer. → Exit

For information on the trigger level, see the specifications. (p.71)
An inrush current including DC components cannot be measured accurately.

2

2.7 Simple event recording function

The instrument can update the maximum value display from the start to the stop of recording. The blinking red backlight will warn you that the maximum value exceeds the set threshold value.

1 Enable the simple event recording function.

In the power-off state



2 Set the range (main readout). Set the threshold value (sub-readout). (p.46)

3 Set the filter.



→ Switch between on and off.



→ **Confirm**
The buzzer will sound.

4 Start recording.



→ **Recording will start.**

Simple event recording function

- 5 Recording in progress** An event with a duration time of less than 400 ms may not be accurately measured, failing to detect the event.

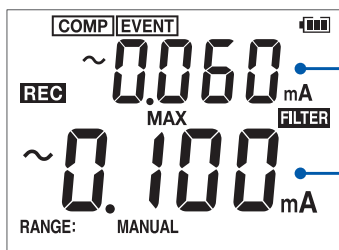

Presently measured value

To freeze the value



Press. (Pressing the key again can disable the function.)

Maximum value from the recording start

The blinking red backlight will warn you that the maximum value exceeds the set threshold value.

- 6 Stop recording.**

Press **MAX/MIN**, **RANGE**, or **COMP**, and then,  within 3 s* → Recording stops.



The instrument will reset the maximum value and return to step 4 (Start measurement).

To switch the range or change the threshold value

Press ▲ **MAX/MIN** or ▼ **RANGE**



Return to step 2 (Set the range, Set the threshold value).

* If you fail to press **HOLD** within 3 s, the instrument will return to step 5 (During recording).

To disable the simple event recording function

Cycle the instrument.

48

2.8 Output function (OUTPUT) CM4003

The voltage corresponding to the measured value can be output. (Procedure: p.51)

RMS (RMS value output)	Outputs the DC voltage proportional to the RMS value of the measured current. Recording the voltage with a recorder (such as Hioki's Memory HiCorder) allows you to check changes in measured current value visually.
WAVE (Waveform output)	Outputs the AC voltage proportional to the measured current. Observing the voltage with a recorder (such as Hioki's Memory HiCorder, etc.) allows you to check the current waveform visually.

Use an external power supply for long-term measurement. (p.29)

- When using the scaling function of a recorder (such as Hioki's Memory HiCorder), the voltage value can be converted into the current value on the recorder.
- To identify intermittent earth leakage (occasional earth leakage) events, record the RMS output with the recorder to check it for temporal fluctuations of the leakage current value.

Output function (OUTPUT)

Output rate (A-to-V conversion ratio)

Range	Output rate	Output accuracy	
		RMS (RMS value)	WAVE (waveform)
6.000 mA	600.0 mV / 6.000 mA	±1.0% rdg ±5 mV (For the display count)	±3.0% rdg ±10 mV (45 Hz to 400 Hz)
60.00 mA	600.0 mV / 60.00 mA		
600.0 mA	600.0 mV / 600.0 mA		
6.000 A	600.0 mV / 6.000 A		±5.0% rdg ±10 mV (15 Hz to 45 Hz, 400 Hz to 2 kHz)
60.00 A	600.0 mV / 60.00 A		
200.0 A	200.0 mV / 200.0 A		

The instrument outputs 600.0 mV as the voltage corresponding to the current range's full-scale count of 6000. Only when the 200.0 A range is used, the instrument outputs 200.0 mV AC/DC as the voltage that corresponds to the full-scale count of 2000.

Example: When the 600.0 mA range is used, the instrument outputs 300.0 mV as the voltage that corresponds to 300.0 mA.

Output response

RMS (RMS value)	Refresh rate: 5 times/s
WAVE (waveform)	Frequency band: 15 Hz to 15 kHz (within ±3 dB)

Setting the output function (RMS/WAVE)

Follow the instruction below to set the output function.

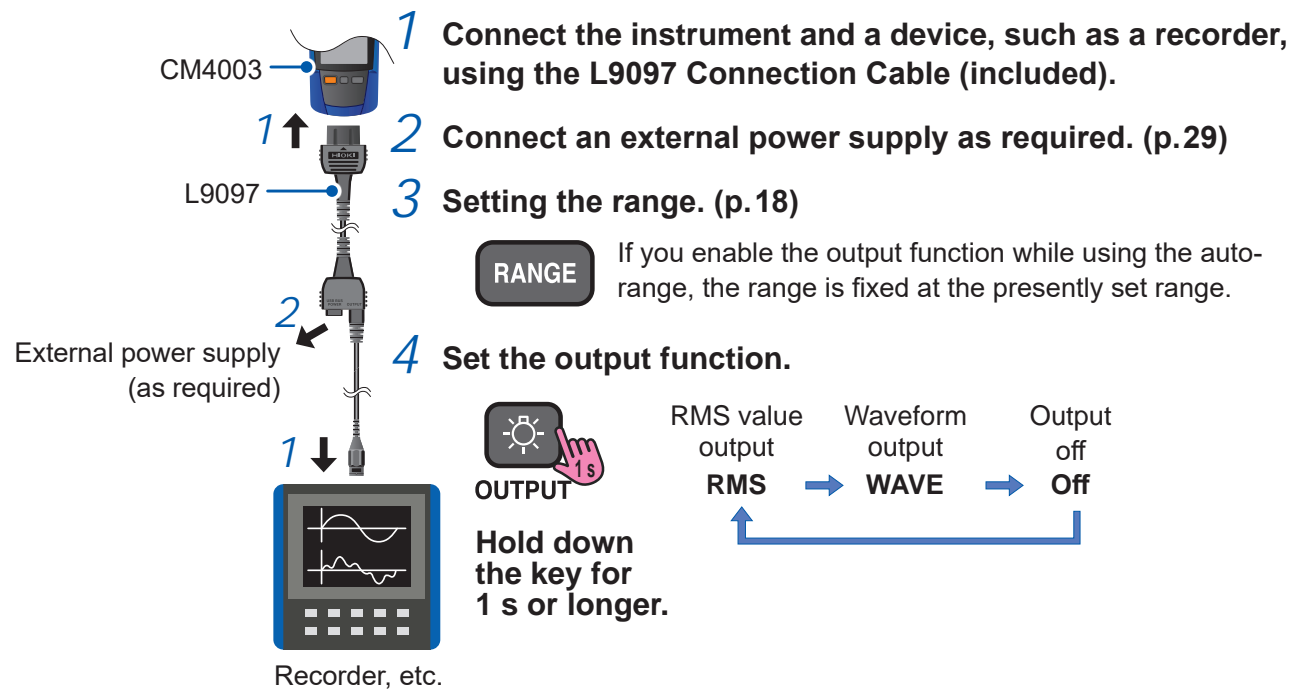

Output function (OUTPUT)

Precautions for using the output function

- If you enable the output function while using the auto-range (AUTO), the auto-range is canceled and the range is fixed at the presently set range.
- The measured frequency value cannot be output.
- Even when you press the **HOLD** key, the output voltage is not fixed.
- Use an instrument (for example, recorder) with a high input-impedance to record the output. (An instrument with an input impedance of 100 k Ω or more is recommended.)
- When the output function is enabled, the auto-power save function (APS) is disabled.



Using the filter function can eliminate unnecessary high-frequency components. (p.39)

2.9 Auto-Power Save Function (APS)

Using the auto-power save function can reduce the battery consumption. When you turn on the instrument, the auto-power save function is enabled automatically. When using the instrument continuously for an extended period of time, disable the auto-power save function.

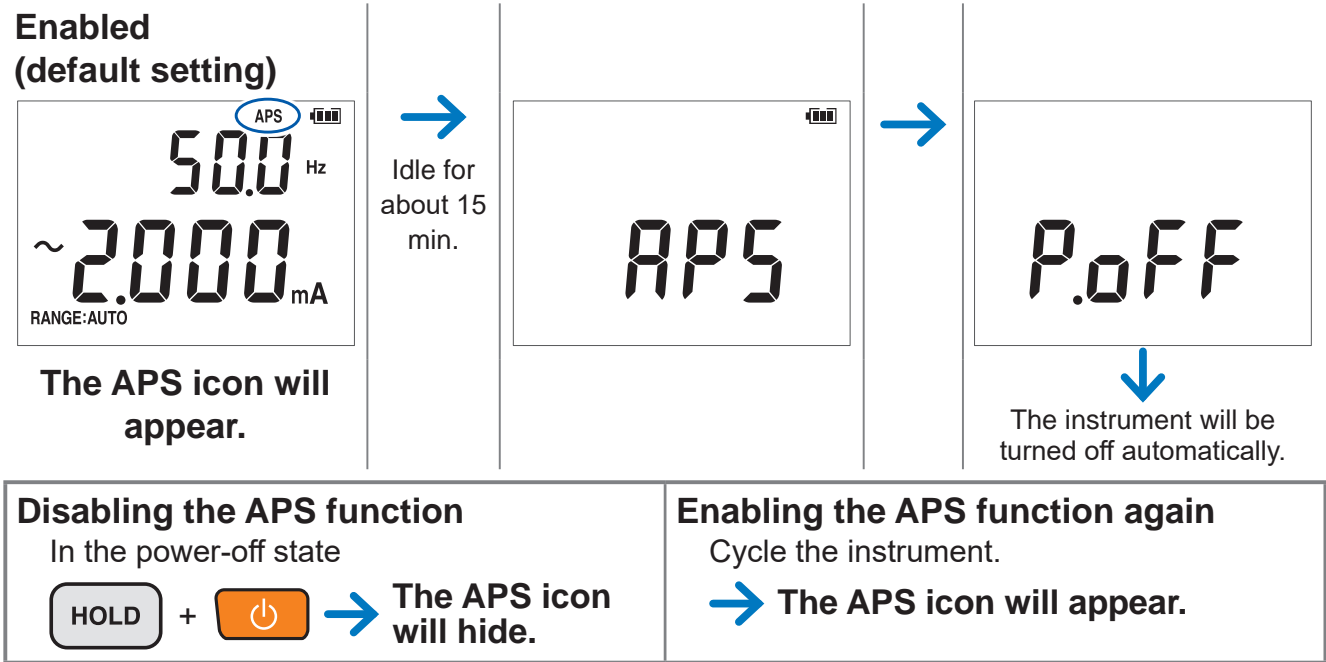

2

Backlight

2.10 Backlight

Display backlight

When the backlight is lit, the display panel can be seen easily even in a dark place.

Not lit

(Default setting)

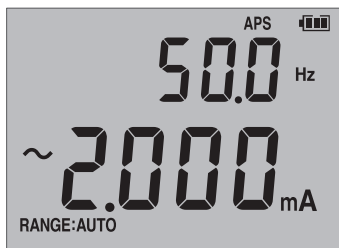

Lit (in white)

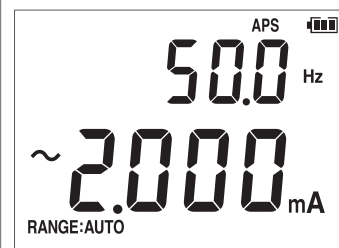

Otherwise, no operation for about 40 s will turn off the backlight automatically.*

* You can disable the automatic backlight shutoff. (p.65)

Warning backlight

When any of the following occurs, the backlight will light up or blink in red to warn you.

- When excessive current is input
When the measured current exceeds the measurement range, the full-scale value on the main readout or sub-readout and **OVER** will blink. Quit the measurement immediately.
- When the measured current exceeds the measurement range (overrange)
The full-scale value on the main readout or sub-readout and **OVER** will blink. Switch over to an appropriate range.
- When the comparator function detects that the measured value exceeds the threshold value (p.46)

2

Off

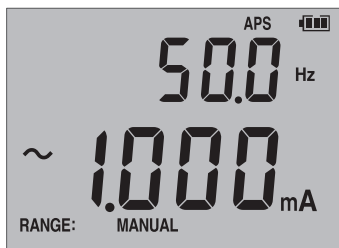

Automatically

Lit/Blinking (in red)

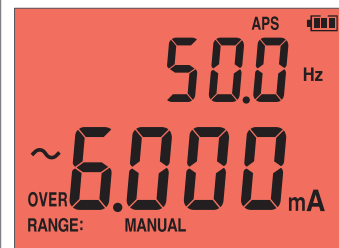

The warning backlight operates only for the present measured value. The warning backlight does not operate for the freezing value and recorded values of the MAX, MIN, AVG, PEAK MAX, and PEAK MIN display functions.

2.11 Wireless Communications Function

When the Z3210 Wireless Adapter (option) is installed, the wireless communications function can be used. Concurrent use of GENNECT Cross and HID function (p.61) is not available.

Using GENNECT Cross

Using GENNECT Cross allows you to check and record the measured data of the instrument, and create measurement reports using your mobile device.

- The communication distance is about 10 m with a clear line of sight. The communicable distance may vary greatly depending on the presence of an obstruction (wall or metallic shielding object) and the distance between the floor (ground) and instrument. To ensure the stable communication, make sure that the radio wave intensity is sufficient.
- GENNECT Cross is free of charge. However, the customer is responsible for the cost to download the application software and connect to the Internet when using the software.
- GENNECT Cross may not operate properly depending on the mobile device.
- The Z3210 uses the 2.4 GHz band wireless technology.
When there is a device that uses the same frequency band such as a wireless LAN (IEEE 802.11.b/g/n) near your mobile device, the communication may not be established.



When the instrument is placed on the floor or ground, the communication distance becomes shorter. It is recommended that you move the instrument from the floor or ground and place it on a desk or table or hold it by hand.

Using the wireless communications function

- 1 Connect the Z3210 Wireless Adapter (option) into the instrument. (p.28)
- 2 Install GENNECT Cross on your mobile device.
- 3 Turn on the instrument, and then enable the wireless communications function.

2

Off
(Default setting)



Hold down the key for
1 s or longer.



+ 1 s



The  icon will appear.

(Wireless communications function is enabled.)

Hidden: Wireless communications function is disabled.

Blinking: Communicating with your mobile device.

Wireless Communications Function

4 Start GENNECT Cross and register the connection of the instrument.

Tap [Other].

Tap [Instrument Settings].

Choose the instrument you wish to connect.



- When GENNECT Cross is started for the first time (when there is no registered instrument), the Instrument Settings screen appears.
- When the instrument is placed near your mobile device, its connection is registered automatically on the Instrument Settings screen of GENNECT Cross (up to eight instruments).
- Wait for 5 to 30 s until the connection of the instrument is registered after turning on the instrument. If the connection of the instrument is not registered after 1 minute has elapsed, restart GENNECT Cross and the instrument.

58

5 Choose a measurement function to perform measurement.



General measurement



Logging (recording)



Waveform graph/FFT



Comparator



Photo drawing function



Harmonic analysis



Event recording (p. 60)



Firmware updating of the instrument

2

Wireless Communications Function

Event Recording Function (EVENT)

The event recording function logs the data when measured values exceed a desired threshold value, which can be set with GENNECT Cross. For details, see the Help function in GENNECT Cross. The number of recorded events can be checked using the instrument.

Hold down
the key for 1 s
or longer.



Displays the number of
events.

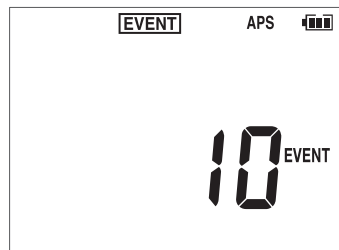

- An event with a duration time of less than 200 ms may not be accurately measured, failing to detect the event.
- The instrument can record up to 999 events. The event recording will terminate when the recorded events reach 999 in number. When you start another event recording session, the instrument will delete previously recorded data.

Z3210-to-Excel direct data entry function (Excel direct input function, HID function)

Concurrent use of GENNECT Cross and HID function is not available. The human interface device (HID) profile, with which the Z3210 Wireless Adapter is equipped, is a profile same as that wireless keyboards use.

HID ON	Preparatory to data entry, open an Excel file on your mobile device or computer and choose a cell. When the instrument's display freezes, the measured values will be entered on the cells. The use of this function with the automatic hold function enabled comes in handy. (p.41)
HID OFF	When you wish to use GENNECT Cross, disable the HID function.

The setting whether the HID function has been enabled or disabled will not be saved in the instrument but in the Z3210.

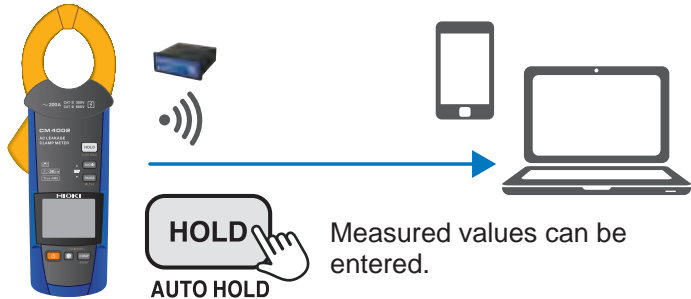

Wireless Communications Function

Confirming the HID setting

1 Remove the instrument from the object under measurement and turn off the instrument.

2 Connect the Z3210 Wireless Adapter (option) into the instrument.

See “Installation/replacement procedure” (p.28).

3 Enable the wireless communications function.

Turn on the instrument, and then hold down **HOLD** + **COMP** simultaneously for 1 s or more.

4 Confirm the HID setting.

Turn off the instrument, and then press **HOLD** + **MAX/MIN** + . The HID setting saved in the Z3210 will be displayed.

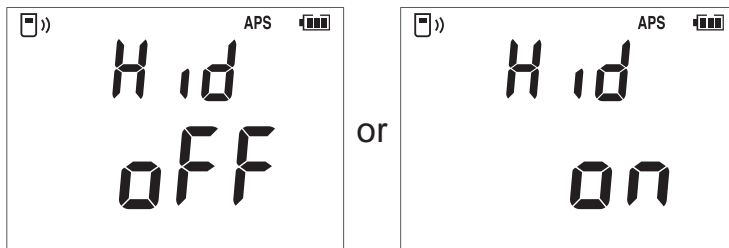

To toggle the setting,
go on to the next page.

Toggle the HID setting

1 Turn off the instrument, and then press **HOLD** + **COMP** + **Power**.

After displaying the following screens in turn, the instrument will be turned off automatically.

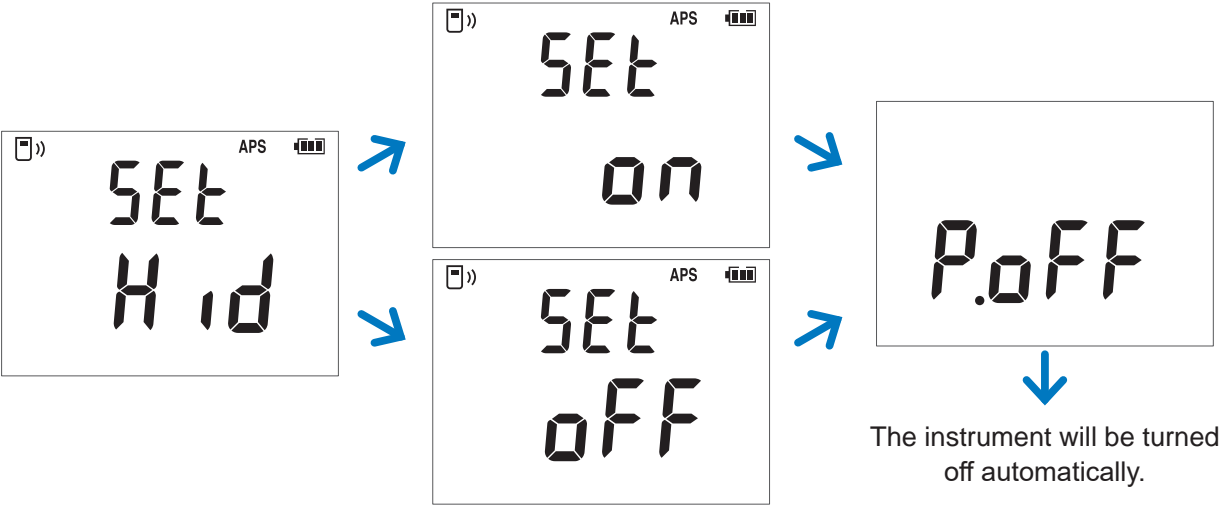

2 Turn on the instrument again.
Toggle the HID setting.

If the HID function cannot be enabled

Use GENNECT Cross (ver. 1.8 or later) to update the Z3210.

2

Wireless Communications Function

IMPORTANT













To switch over from the HID function to GENNECT Cross

If you start GENNECT Cross without canceling the pairing between the mobile device and the instrument, GENNECT Cross may not be able to recognize the instrument as a connectible device. Follow the procedure below to reconnect the instrument to GENNECT Cross.









1. Use the **Bluetooth**[®] setting of your mobile device to delete the instrument.
2. Disable the Z3210's HID function. (p.63)
3. Use the Instrument Setting of GENNECT Cross to reconnect the instrument.

2.12 Power Key Combinations

Turn off the instrument, and then turn it on again while holding down one or two operation keys.

Settings	How to turn on the instrument	Factory-shipped setting	Saving of setting
Auto-power save (APS) function (disabled, p.53)	 + 	Enabled	Not saved
Model number, firmware version number, all segments display (p.20)	 + 	–	–
Filter function (enabled/disabled at startup, p.39)	 + 	Disabled at startup	Saved
Buzzer sound (enabled/disabled)	 + 	Enabled	Saved
Automatic deactivation of the display backlight (enabled/disabled, p.54)	 + 	Enabled	Saved
Serial number display	 +  + 	–	–

Power Key Combinations

Settings	How to turn on the instrument	Factory-shipped setting	Saving of setting
Simple event recording function (p.47)	 +  + 	–	Range Threshold value
Confirmation of the HID setting (p.62)	 +  + 	–	–
HID setting (enabled/disabled, p.63)	 +  + 	Off	Saved

3

Specifications

3.1 General Specifications

Operating environment	Indoors, pollution degree 2, altitude up to 2000 m (6562 ft.)
Operating temperature and humidity range	-10°C to 40°C (14°F to 104°F), 80% RH or less (non-condensing) 40°C to 45°C (104°F to 113°F), 60% RH or less (non-condensing) 45°C to 65°C (113°F to 149°F), 50% RH or less (non-condensing)
Storage temperature and humidity range	-30°C to 70°C (-22°F to 158°F), 80% RH or less (non-condensing)
Dust resistance and water resistance	IP40 (with the jaws closed) (EN 60529) The protection rating for the enclosure of this instrument is *IP40. *IP40: This indicates the degree of protection provided by the enclosure of the device for use in hazardous locations, entry of solid foreign objects, and the ingress of water. “4”: Protected against access to hazardous parts with wire measuring 1.0 mm in diameter. The equipment inside the enclosure is protected against entry by solid foreign objects larger than 1.0 mm in diameter. “0”: The equipment inside the enclosure is not protected against the harmful effects of water.

General Specifications

Standards	Safety EN 61010 EMC EN 61326	
Applicable standard	IEC/EN 61557-13:2011 Class 2, ≤ 30 A/m	
Power supply	CM4002 CM4003	<ul style="list-style-type: none"> • LR6 Alkaline batteries ×2 Rated supply voltage: 1.5 V DC × 2 Maximum rated power: 800 mVA • HR6 Nickel-metal hydride batteries ×2 Rated supply voltage: 1.2 V DC × 2 Maximum rated power: 800 mVA
	CM4003	<ul style="list-style-type: none"> • External power supply (USB power) Rated supply voltage: 5 V DC Maximum rated power: 1000 mVA
Continuous operating time	When two LR6 Alkaline batteries are used Approx. 48 hours (with the Z3210 not installed) Approx. 30 hours (with the Z3210 installed and while wirelessly communicating) With the backlight shut off and no signal input Values used for reference purposes at an ambient temperature of 23°C	
Maximum diameter of measurable conductor	φ40 mm	
Dimensions	Approx. 64W × 233H × 37D mm (2.52"W × 9.17"H × 1.46"D) (Excluding those of protrusions, lever, and jaws)	
Jaw dimensions	Approx. 75W × 20D mm (2.95"W × 0.79"D)	
Mass	Approx. 400 g (14.1 oz.) (Excluding batteries)	

68

General Specifications

Product warranty period	3 years or 10,000 cycles of jaws opening/closing operations, whichever is shorter
Accessories	See p.i.
Options	See p.8.

3.2 Input, Output, and Measurement Specifications

Basic specifications

Measurement parameters	AC current	~A
	Power frequency	Hz
Measurable range	See “Accuracy list” (p.74).	
Maximum input current	In accordance with the frequency derating characteristics (p.71)	
Maximum rated terminal-to-ground voltage	CM4002	300 V AC (Measurement category IV) 600 V AC (Measurement category III) Anticipated transient overvoltage 6000 V
	CM4003	300 V AC (Measurement category III) Anticipated transient overvoltage 4000 V
Measurement method	True RMS method	

Measurement specifications

Display refresh rate	AC current	5 times/s
	Frequency	1 to 2 times/s
The switching time between ranges is not included.		
Response time	AC current	2.5 s or less
Zero display range	5 counts or less	

Input, Output, and Measurement Specifications

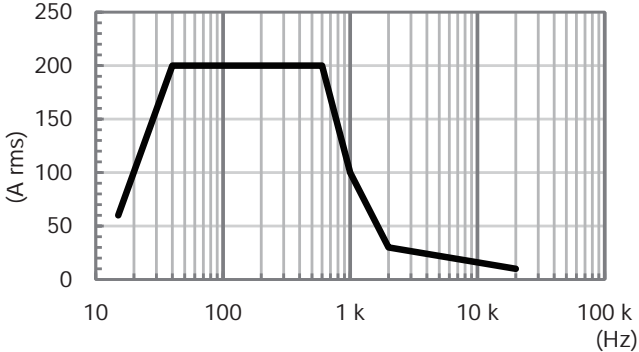
Frequency derating characteristics		
Crest factor	3 (other than 200.0 A range), 1.5 (200.0 A range)	
Peak detection time width	2 ms or more (with filter disabled)	
Frequency detection input level	5% or more of f.s. in each range	
Inrush trigger level	600.0 mA range	Not less than +60.0 mA (peak) or not exceeding -60.0 mA (peak)
	6.000 A range	Not less than +0.600 A (peak) or not exceeding -0.600 A (peak)
	60.00 A range	Not less than +2.00 A (peak) or not exceeding -2.00 A (peak)
	200.0 A range	Not less than +10.0 A (peak) or not exceeding -10.0 A (peak)

Input, Output, and Measurement Specifications

Accuracy specifications

Accuracy guarantee conditions	Accuracy guarantee period	1 year
	Accuracy guarantee temperature and humidity range	23°C ±5°C (73°F ±9°F) 80% RH or less (non-condensing)
Accuracy guarantee input conditions	Sine wave input Not exceeding the rated current and the derating curve	
Measurement accuracy	See "Accuracy list" (p. 74).	
Effect of external magnetic field	4 mA or less (In an external magnetic field of 400 A/m AC with 50 Hz/60 Hz)	
Effect of conductor position	Within ±0.1% rdg (less than 100 A) Within ±0.5% rdg (100 A or more) (At any position based on the center of the jaws)	
Effect of radiated radio-frequency electro-magnetic field	Add ±2 mA to the measurement accuracy. (In a radiated radio-frequency electro-magnetic field of 10 V/m)	
Effect of conducted radio-frequency electro-magnetic field	Add ±2 mA to the measurement accuracy. (In a conducted radio-frequency electro-magnetic field of 10 V)	

Input, Output, and Measurement Specifications

Temperature coefficient	Add (Measurement accuracy × 0.05)/°C to the measurement accuracy. (Specified outside a range of 23°C ±5°C)
--------------------------------	---

Input, Output, and Measurement Specifications

Accuracy list

(1) AC current

1. RMS value measurement (Measured value, maximum, minimum, and average)

Range (Auto-range threshold value: Switch over to higher/lower range)	Accuracy guarantee range (Resolution)	Accuracy guarantee frequency range	Measurement accuracy	
			Filter disabled	Filter enabled
6.000 mA (over 6000 counts)	0.060 mA to 6.000 mA (0.001 mA)	15 Hz ≤ f < 45 Hz	±2.0% rdg ±0.005 mA	±3.0% rdg ±0.005 mA
		45 Hz ≤ f ≤ 66 Hz	±1.0% rdg ±0.005 mA	±1.0% rdg ±0.005 mA
		66 Hz < f ≤ 400 Hz		–
		400 Hz < f ≤ 2 kHz	±2.0% rdg ±0.005 mA	–
60.00 mA (over 6000 counts / less than 540 counts)	0.60 mA to 60.00 mA (0.01 mA)	15 Hz ≤ f < 45 Hz	±2.0% rdg ±0.05 mA	±3.0% rdg ±0.05 mA
		45 Hz ≤ f ≤ 66 Hz	±1.0% rdg ±0.05 mA	±1.0% rdg ±0.05 mA
		66 Hz < f ≤ 400 Hz		–
		400 Hz < f ≤ 2 kHz	±2.0% rdg ±0.05 mA	–
600.0 mA (over 6000 counts / less than 540 counts)	6.0 mA to 600.0 mA (0.1 mA)	15 Hz ≤ f < 45 Hz	±2.0% rdg ±0.5 mA	±3.0% rdg ±0.5 mA
		45 Hz ≤ f ≤ 66 Hz	±1.0% rdg ±0.5 mA	±1.0% rdg ±0.5 mA
		66 Hz < f ≤ 400 Hz		–
		400 Hz < f ≤ 2 kHz	±2.0% rdg ±0.5 mA	–

Input, Output, and Measurement Specifications

Range (Auto-range threshold value: Switch over to higher/lower range)	Accuracy guarantee range (Resolution)	Accuracy guarantee frequency range	Measurement accuracy	
			Filter disabled	Filter enabled
6.000 A (over 6000 counts / less than 540 counts)	0.060 A to 6.000 A (0.001 A)	15 Hz ≤ f < 45 Hz	±2.0% rdg ±0.005 A	±3.0% rdg ±0.005 A
		45 Hz ≤ f ≤ 66 Hz	±1.0% rdg ±0.005 A	±1.0% rdg ±0.005 A
		66 Hz < f ≤ 400 Hz		–
		400 Hz < f ≤ 2 kHz	±2.0% rdg ±0.005 A	–
60.00 A (over 6000 counts / less than 540 counts)	0.60 A to 60.00 A (0.01 A)	15 Hz ≤ f < 45 Hz	±2.0% rdg ±0.05 A	±3.0% rdg ±0.05 A
		45 Hz ≤ f ≤ 66 Hz	±1.5% rdg ±0.05 A	±1.5% rdg ±0.05 A
		66 Hz < f ≤ 400 Hz		–
		400 Hz < f ≤ 2 kHz	±2.0% rdg ±0.05 A	–
200.0 A (less than 540 counts)	6.0 A to 200.0 A (0.1 A)	15 Hz ≤ f < 45 Hz	±2.0% rdg ±0.5 A	±3.0% rdg ±0.5 A
		45 Hz ≤ f ≤ 66 Hz	±1.5% rdg ±0.5 A	±1.5% rdg ±0.5 A
		66 Hz < f ≤ 400 Hz		–
		400 Hz < f ≤ 2 kHz	±2.0% rdg ±0.5 A	–

Input, Output, and Measurement Specifications

2. Peak value measurement (PEAK MAX / PEAK MIN)

Range	Accuracy guarantee range (Resolution)	Accuracy guarantee frequency range	Measurement accuracy	
			Filter disabled	Filter enabled
6.000 mA	±0.9 mA to ±18.00 mA (0.01 mA)	15 Hz ≤ f < 45 Hz	±3.0% rdg ±0.05 mA	±4.0% rdg ±0.05 mA
		45 Hz ≤ f ≤ 66 Hz	±2.0% rdg ±0.05 mA	±2.0% rdg ±0.05 mA
		66 Hz < f ≤ 400 Hz		–
		400 Hz < f ≤ 2 kHz	±3.0% rdg ±0.05 mA	–
60.00 mA	±1.8 mA to ±180.0 mA (0.1 mA)	15 Hz ≤ f < 45 Hz	±3.0% rdg ±0.5 mA	±4.0% rdg ±0.5 mA
		45 Hz ≤ f ≤ 66 Hz	±2.0% rdg ±0.5 mA	±2.0% rdg ±0.5 mA
		66 Hz < f ≤ 400 Hz		–
		400 Hz < f ≤ 2 kHz	±3.0% rdg ±0.5 mA	–
600.0 mA	±18 mA to ±1800 mA (1 mA)	15 Hz ≤ f < 45 Hz	±3.0% rdg ±5 mA	±4.0% rdg ±5 mA
		45 Hz ≤ f ≤ 66 Hz	±2.0% rdg ±5 mA	±2.0% rdg ±5 mA
		66 Hz < f ≤ 400 Hz		–
		400 Hz < f ≤ 2 kHz	±3.0% rdg ±5 mA	–

Input, Output, and Measurement Specifications

Range	Accuracy guarantee range (Resolution)	Accuracy guarantee frequency range	Measurement accuracy	
			Filter disabled	Filter enabled
6.000 A	±0.18 A to ±18.00 A (0.01 A)	15 Hz ≤ f < 45 Hz	±3.0% rdg ±0.05 A	±4.0% rdg ±0.05 A
		45 Hz ≤ f ≤ 66 Hz	±2.0% rdg ±0.05 A	±2.0% rdg ±0.05 A
		66 Hz < f ≤ 400 Hz		–
		400 Hz < f ≤ 2 kHz	±3.0% rdg ±0.05 A	–
60.00 A	±1.8 A to ±180.0 A (0.1 A)	15 Hz ≤ f < 45 Hz	±5.0% rdg ±0.5 A	±5.0% rdg ±0.5 A
		45 Hz ≤ f ≤ 66 Hz	±3.0% rdg ±0.5 A	±3.0% rdg ±0.5 A
		66 Hz < f ≤ 400 Hz		–
		400 Hz < f ≤ 2 kHz	±5.0% rdg ±0.5 A	–
200.0 A	±18 A to ±300 A (1 A)	15 Hz ≤ f < 45 Hz	±5.0% rdg ±5 A	±5.0% rdg ±5 A
		45 Hz ≤ f ≤ 66 Hz	±3.0% rdg ±5 A	±3.0% rdg ±5 A
		66 Hz < f ≤ 400 Hz		–
		400 Hz < f ≤ 2 kHz	±5.0% rdg ±5 A	–

Input, Output, and Measurement Specifications

(2) AC INRUSH (Inrush current)

1. AC INRUSH measured value

Range	Accuracy guarantee range (Resolution)	Accuracy guarantee frequency range	Measurement accuracy
600.0 mA	60.0 mA to 600.0 mA (0.1 mA)	40 Hz ≤ f ≤ 1 kHz	±5.0% rdg ±1.0 mA
6.000 A	±0.600 A to ±6.000 A (0.001 A)	40 Hz ≤ f ≤ 1 kHz	±5.0% rdg ±0.010 A
60.00 A	±1.00 A to ±60.00 A (0.01 A)	40 Hz ≤ f ≤ 1 kHz	±5.0% rdg ±0.10 A
200.0 A	±10.0 A to ±200.0 A (0.1 A)	40 Hz ≤ f ≤ 1 kHz	±5.0% rdg ±1.0 A

2. AC INRUSH PEAK value

Range	Accuracy guarantee range (Resolution)	Accuracy guarantee frequency range	Measurement accuracy
600.0 mA	60 mA to 1800 mA (1 mA)	40 Hz ≤ f ≤ 1 kHz	±6.0% rdg ±10 mA
6.000 A	±0.60 A to ±18.00 A (0.01 A)	40 Hz ≤ f ≤ 1 kHz	±6.0% rdg ±0.10 A
60.00 A	±1.0 A to ±180.0 A (0.1 A)	40 Hz ≤ f ≤ 1 kHz	±6.0% rdg ±1.5 A
200.0 A	±10 A to ±300 A (1 A)	40 Hz ≤ f ≤ 1 kHz	±6.0% rdg ±15 A

(3) Frequency measurement

Range (Auto-range threshold value)	Accuracy guarantee range (Resolution)	Measurement accuracy
999.9 Hz (over 9999 counts)	15.0 Hz to 999.9 Hz (0.1 Hz)	±0.1% rdg ±0.1 Hz
2000 Hz (less than 900 counts)	900 Hz to 2000 Hz (1 Hz)	±0.1% rdg ±1 Hz

Output specifications CM4003

Output item	RMS (RMS value output)
	WAVE (waveform output)
Output level (Output rate: p. 50)	RMS: 600 mV DC/f.s. (other than 200.0 A range) 200 mV DC/f.s. (200.0 A range) (outputs a voltage of 1 V when the f.s. of the range is exceeded.)
	WAVE: 600 mV AC/f.s. (other than 200.0 A range) 200 mV AC/f.s. (200.0 A range)
Output accuracy	RMS: $\pm 1.0\%$ rdg ± 5 mV (for the display count)
	WAVE: $\pm 3.0\%$ rdg ± 10 mV (45 Hz to 400 Hz) $\pm 5.0\%$ rdg ± 10 mV (15 Hz to 45 Hz, 400 Hz to 2 kHz)
Output response	RMS: Refresh rate: 5 times/s
	WAVE: Frequency band: 15 Hz to 15 kHz (Within ± 3 dB)
Output impedance	100 Ω or less

Compatibility with IEC/EN 61557-13

3.3 Compatibility with IEC/EN 61557-13

Specified input range	6 mA to 60 A, 40 Hz to 1 kHz
Intrinsic uncertainty (A)	See "Accuracy list" (p.74).
Effects of position (E1)	Add $\pm 0.1\%$ rdg ± 1 dgt.
Effects of operation voltage (E2)	Add $\pm 0.1\%$ rdg ± 1 dgt.
Effects of temperature (E3)	Add $\pm 0.05 \times$ (specified accuracy)/ $^{\circ}\text{C}$. $< 18^{\circ}\text{C}$, $> 25^{\circ}\text{C}$
Effects of distortion waveform (E9)	Add $\pm 1\%$ rdg.
Effects of external magnetic field (E11) 15 Hz to 400 Hz	Class 3 10 A/m: Add ± 0.22 mA. Class 2 30 A/m: Add ± 0.65 mA.
Effects of load current (E12)	Add ± 10 μA per load current.
Effects of common mode voltage (E13)	Add $\pm 0.5\%$ rdg.
Effects of frequency (E14)	Add $\pm 1.0\%$ rdg.
Reproducibility (E15)	Add $\pm 0.5\%$ rdg.
Percentage operation uncertainty (B)	Class 3 10 A/m: Below 15% (measurement current: 6 mA to 10 mA) Below 10% (measurement current: 10 mA or more) Class 2 30 A/m: Below 20% (measurement current: 6 mA to 10 mA) Below 12.5% (measurement current: 10 mA or more)

80

4

Maintenance and Service

Calibration

The calibration interval depends on factors such as operating conditions and environment. Please determine the appropriate calibration interval based on your operating conditions and environment and have Hioki calibrate it accordingly on a regular basis.

Cleaning

CAUTION

- **If the instrument becomes dirty, wipe it clean with a soft cloth moistened with water or a neutral detergent.**



Never use solvents such as benzene, alcohol, acetone, ether, ketone, thinners, or gasoline. Doing so could cause deformation or discoloration of the instrument.

IMPORTANT

Keep the facing core surfaces of the jaws clean by gently wiping them with a soft dry cloth. Dirt on the surfaces can adversely affect the measurement accuracy..

Wipe the display panel gently with a soft, dry cloth.



Disposing of the Instrument

Dispose of the instrument in accordance with local regulations.

4.1 Troubleshooting

If damage is suspected, read the "Troubleshooting" section to remedy the problem. If this does not help you, contact your authorized Hioki distributor or reseller.

Before sending the instrument to be repaired

Problem	Cause	Corrective action (Reference)
The instrument cannot be turned on. The instrument shuts off during operation. The instrument shuts off immediately after it has been turned on.	The batteries are exhausted.	Replace the batteries with new ones. (p.28)
	The instrument has sat idle for about 15 minutes with the auto-power save function (APS) enabled.	Check the settings. (p.53)
The  mark blinks. [bAtt] → [P.oFF] → shutdown	The batteries are exhausted.	Replace the batteries with new ones. (p.28)
The range cannot be changed.	The MAX / MIN / AVG / PEAK MAX / PEAK MIN display function is used.	Hold down the  key for 1 s or longer to reset the function, and then change the range. (p.44)

Troubleshooting

Problem	Cause	Corrective action (Reference)
The output rate differs from the specifications. The output is small.	The 200.0 A range is used.	Check the current range. The 200.0 A has an output rate of 200 mV/f.s. This rate differs from the other ranges' rates .
	The equipment that receives the output has a low input impedance.	Check the input impedance of the equipment that receives the output. An input impedance of 100 kΩ or more is recommended.
	The frequency of the object under measurement is outside the output accuracy (15 Hz to 2 kHz) range.	The frequency band (15 Hz to 15 kHz) shows a band where the output attenuation is ±3 dB or less. (p. 79)
The measured value is incorrect.	Displayed values can frequently fluctuate due to induction potential even when no voltage is applied. This, however, is not a malfunction.	–
	The tip of the jaws is open.	Close the jaws.
	The jaws are damaged. When a jaw is damaged or cracked, the current cannot be measured accurately.	Have the instrument repaired.

Troubleshooting

Problem	Cause	Corrective action (Reference)
The measured value does not change.	The readouts freeze.	Disable the hold function. (p.41)
The jaws generate a sound (vibration) during measurement.	When a large magnitude of load current or a high-frequency current is measured, resonance sounds may be generated on rare occasions. There are individual differences in loudness of the sound, but it does not affect the measurement.	–
The wireless communications cannot be established.	The Z3210 is not installed.	Install the Z3210. (p.28)
	The wireless communications function is disabled.	Enable the wireless communications function. (p.57)
	The settings of the GENNECT Cross are incorrect.	Check the settings of the GENNECT Cross and your mobile device (GPS, etc.). (See the operation guide for the GENNECT Cross.)

Error Displays

Problem	Cause	Corrective action (Reference)
GENNECT Cross does not work.	The HID function has been enabled. If the HID function has been enabled, the instrument cannot connect with GENNECT Cross properly.	Follow the procedure below to reconnect the instrument to GENNECT Cross. 1. Use the Bluetooth setting of your mobile device to delete the instrument. 2. Disable the Z3210's HID function. (p.63) 3. Use the Instrument Setting of GENNECT Cross to reconnect the instrument.
An error is displayed.	See p.86.	Have the instrument repaired.

4.2 Error Displays

Error display	Description	Corrective action
Err 001	ROM error (Program)	When an error is displayed on the display panel, repair is required. Please contact your authorized Hioki distributor or reseller.
Err 002	ROM error (Adjustment data)	
Err 004	Memory error	
Err 008	Z3210 communication error (Connection failure, the Z3210 or hardware malfunction)	

86

Index

A

AC INRUSH.....	45
APS	53
Disabling.....	53
AUTO HOLD.....	41
Auto-power save.....	53
Disabling.....	53, 65
Average value.....	44
AVG	44

B

Backlight.....	54, 65
Batteries	23, 28
Buzzer sound.....	65

C

COMP.....	46
Comparator function	46

D

Display panel.....	20
Dual-readout screen.....	20

E

Error display	86
EVENT.....	60
Event recording function.....	60
Excel direct entry function	61
External power supply	29

F

FILTER	39
Filter function.....	39
Fluctuation.....	84
Freezing readouts.....	41

G

GENNECT Cross.....	56
--------------------	----

Index

H

HID	61
HOLD.....	41
Auto-hold	41
Manual hold	41
Human interface device profile	61

I

Identifying GFCI and RCD trip events	36
INRUSH.....	45
Inrush current	45
Inrush function	45
Intermittent earth leakage.....	36

J

Jaws	17
------------	----

L

Leakage current.....	4, 31
Load current	38
Low-pass filter	39

M

Main readout.....	20
MAX.....	44
Maximum value	44
Measurement principle	4
Memory HiCorder	49
MIN	44
Minimum value	44
Model Z3210.....	23, 28, 56, 61

N

Noise	39
-------------	----

O

Operation keys	18
Output function	49
Output rate.....	50
Output response	50

P

Part names	16
PEAK.....	44
Peak value.....	44

Photo drawing function 59
Power key combinations..... 65

R

Range 18
Recorder 49
RMS..... 49

S

Serial number 17, 65
Simple event recording function 47
Specifications 67
Sub-readout..... 20

T

Threshold value 46

W

WAVE 49
Wireless adapter..... 23, 28, 56
Wireless communications function 56

Warranty Certificate



Model	Serial number	Warranty period Three (3) years from date of purchase (___ / ___)
Customer name: _____ Customer address: _____		
<p>Important</p> <ul style="list-style-type: none"> · Please retain this warranty certificate. Duplicates cannot be reissued. · Complete the certificate with the model number, serial number, and date of purchase, along with your name and address. The personal information you provide on this form will only be used to provide repair service and information about Hioki products and services. <p>This document certifies that the product has been inspected and verified to conform to Hioki's standards. Please contact the place of purchase in the event of a malfunction and provide this document, in which case Hioki will repair or replace the product subject to the warranty terms described below.</p> <p>Warranty terms</p> <ol style="list-style-type: none"> 1. The product is guaranteed to operate properly during the warranty period (three [3] years from the date of purchase). If the date of purchase is unknown, the warranty period is defined as three (3) years from the date (month and year) of manufacture (as indicated by the first four digits of the serial number in YYYYMM format). 2. If the product came with an AC adapter, the adapter is warranted for one (1) year from the date of purchase. 3. The accuracy of measured values and other data generated by the product is guaranteed as described in the product specifications. 4. In the event that the product or AC adapter malfunctions during its respective warranty period due to a defect of workmanship or materials, Hioki will repair or replace the product or AC adapter free of charge. 5. The following malfunctions and issues are not covered by the warranty and as such are not subject to free repair or replacement: <ol style="list-style-type: none"> -1. Malfunctions or damage of consumables, parts with a defined service life, etc. -2. Malfunctions or damage of connectors, cables, etc. -3. Malfunctions or damage caused by shipment, dropping, relocation, etc., after purchase of the product -4. Malfunctions or damage caused by inappropriate handling that violates information found in the instruction manual or on precautionary labeling on the product itself -5. Malfunctions or damage caused by a failure to perform maintenance or inspections as required by law or recommended in the instruction manual -6. Malfunctions or damage caused by fire, storms or flooding, earthquakes, lightning, power anomalies (involving voltage, frequency, etc.), war or unrest, contamination with radiation, or other acts of God -7. Damage that is limited to the product's appearance (cosmetic blemishes, deformation of enclosure shape, fading of color, etc.) -8. Other malfunctions or damage for which Hioki is not responsible 6. The warranty will be considered invalidated in the following circumstances, in which case Hioki will be unable to perform service such as repair or calibration: <ol style="list-style-type: none"> -1. If the product has been repaired or modified by a company, entity, or individual other than Hioki -2. If the product has been embedded in another piece of equipment for use in a special application (aerospace, nuclear power, medical use, vehicle control, etc.) without Hioki's having received prior notice 7. If you experience a loss caused by use of the product and Hioki determines that it is responsible for the underlying issue, Hioki will provide compensation in an amount not to exceed the purchase price, with the following exceptions: <ol style="list-style-type: none"> -1. Secondary damage arising from damage to a measured device or component that was caused by use of the product -2. Damage arising from measurement results provided by the product -3. Damage to a device other than the product that was sustained when connecting the device to the product (including via network connections) 8. Hioki reserves the right to decline to perform repair, calibration, or other service for products for which a certain amount of time has passed since their manufacture, products whose parts have been discontinued, and products that cannot be repaired due to unforeseen circumstances. 		

HIOKI E.E. CORPORATION

18-07 EN-3

HIOKI

HIOKI E.E. CORPORATION

2402 EN

Edited and published by HIOKI E.E. CORPORATION

Printed in Japan

- Contents subject to change without notice.
- This document contains copyrighted content.
- It is prohibited to copy, reproduce, or modify the content of this document without permission.
- Company names, product names, etc. mentioned in this document are trademarks or registered trademarks of their respective companies.

Europe only

- EU declaration of conformity can be downloaded from our website.