



Metrology Made Simple



ADT760 Calibration Manual

1.800.561.8187

www.itm.com

information@itm.com

ADT760 Calibration Manual

1.0 – Scope

The Additel ADT760 series are portable automated pressure calibrators. These calibrators have three standard models (MA, D and LLP) with a variety of ranges and accuracy to choose from. The ADT760's innovative design contains a built-in pump, interchangeable precision pressure sensor, internal controller, and large touchscreen color display. Additional features include HART communications, data logging, and task documenting. Please read this document carefully before attempting to perform any type of verification or adjustment. Also ensure that the operator has the metrological expertise and equipment to perform the work.

2.0 – References

- Additel 760 Automatic Handheld Pressure Calibrator User Manual
- Additel 773, 783, and 793 User Manual
- Additel 151 Digital Pressure Module Datasheet
- Additel 161 Intelligent Digital Pressure Modules Datasheet
- Additel 286 Multifunction Reference Thermometer Readout User Manual

3.0 – Recommended Equipment and Specifications

Equipment	Specifications	Recommended Model/ Item Number/Description
Pressure Controller	Applicable to the ADT760 pressure ranges	ADT773, ADT783, ADT793
Reference Standard Modules	Applicable to the ADT760 pressure ranges	ADT151, ADT161
Manifolds	Applicable to the ADT760 pressure ranges	ADT121, ADT123
Hoses	Applicable to the ADT760 pressure ranges	ADT100-HTK's, silicone tube, Festo tube, etc.
Connection Cables	USB cable type A to type A	1311000019
Multifunction Calibrator	Applicable to the ADT760 electrical ranges	-
Readout Device / Multimeter	Applicable to the ADT760 electrical ranges	ADT286

4.0 – Environmental Conditions

- Ideal Temperature and Humidity Conditions:
 - $23 \pm 5^{\circ}\text{C}$ with less than 80% relative humidity

5.0 – Diagrams and Descriptions

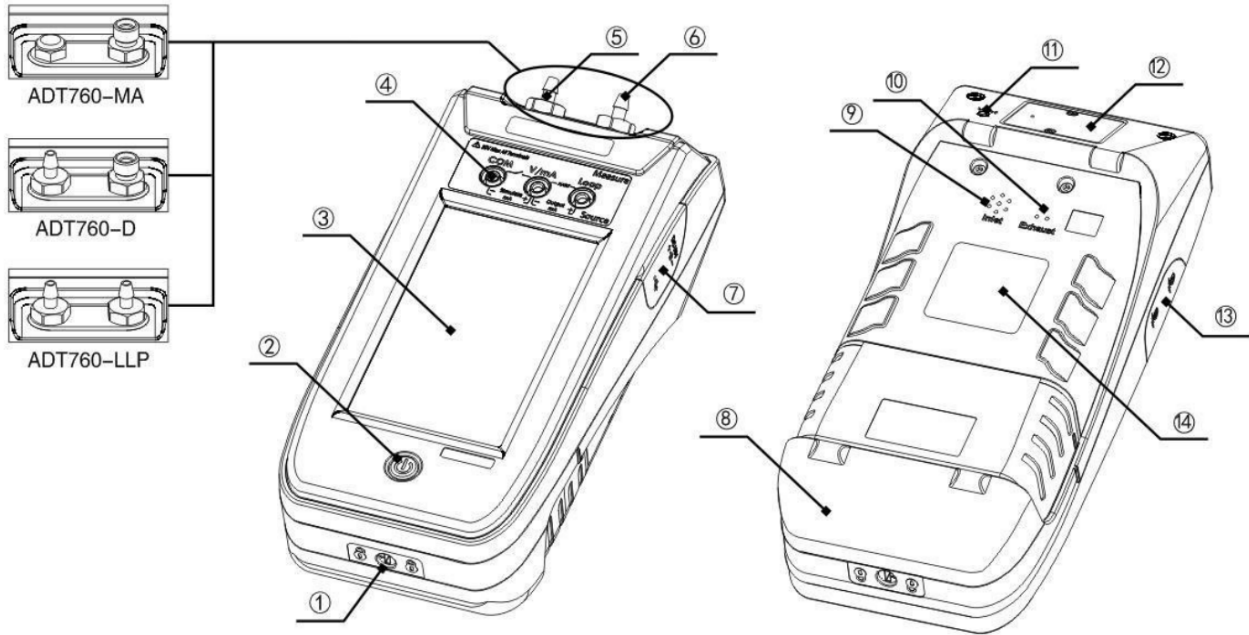

Diagram 5.1
(see chart below)

No.	Name
(1)	Battery Lock
(2)	Power Switch
(3)	Touch Screen
(4)	Electrical Measurement Panel
(5)	REF Port (-MA: Barometer Sensor Calibration Port)
(6)	Pressure Outlet Port
(7)	Power Adapter and USB Port Panel
(8)	Battery
(9)	Inlet Port
(10)	Exhaust Port
(11)	VENT Port
(12)	Internal Pressure Module
(13)	External Pressure Module Connection Ports (A & B)
(14)	Product Nameplate

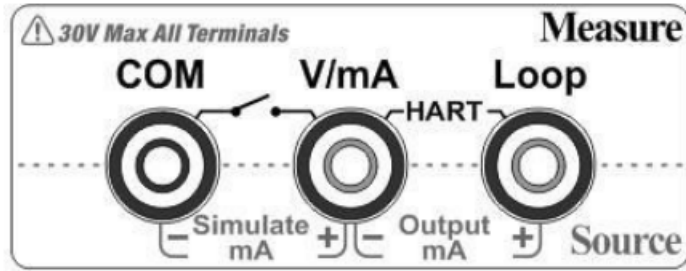

Diagram 5.2
(4 – Electrical Measurement Panel)

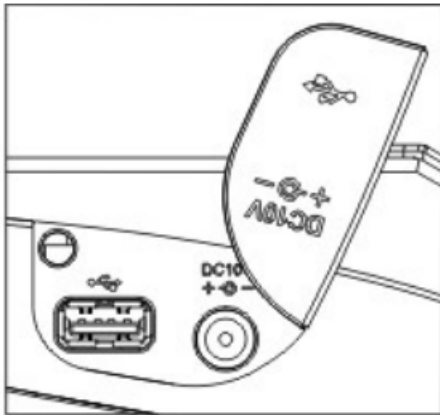

Diagram 5.4
(7 – Power Adapter and USB Port Panel)

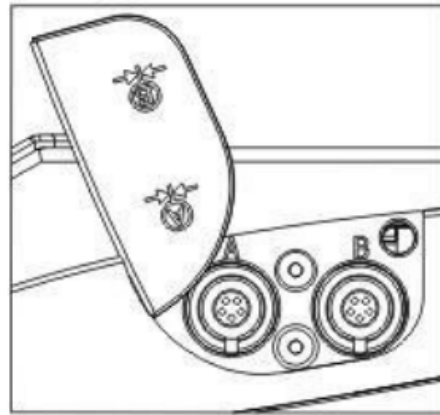
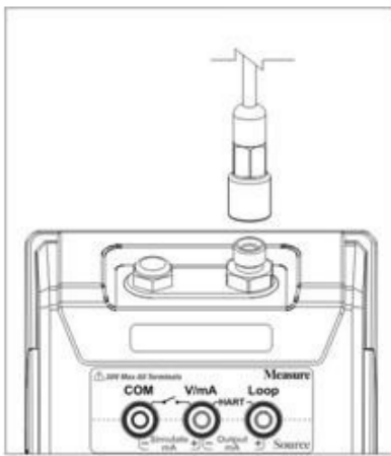
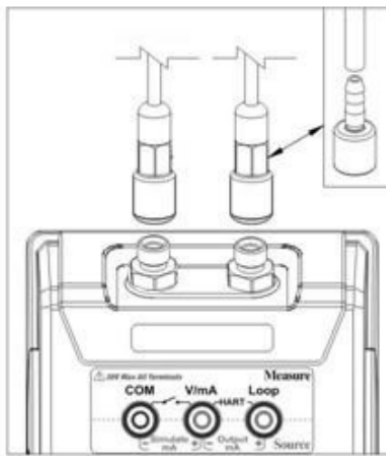

Diagram 5.3
(13 – External Pressure Module Connection Ports A & B)

Diagram 5.5
(Pressure Connection Ports)



ADT760-MA



ADT760-D

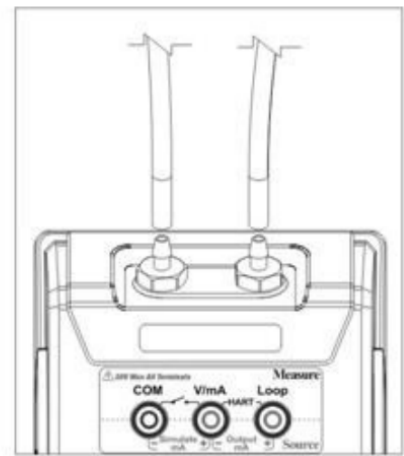

ADT760-LLP

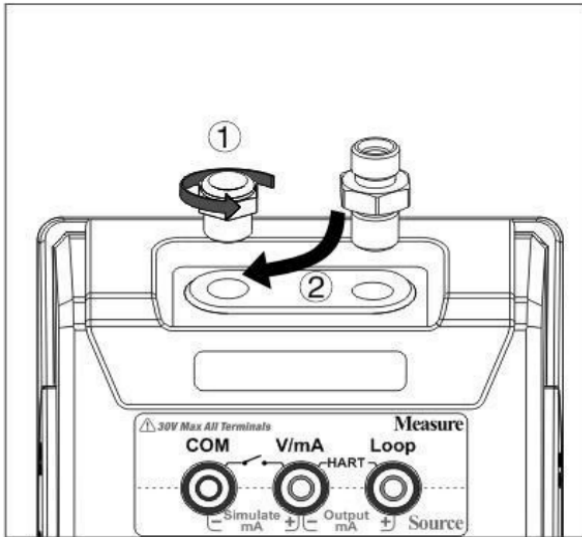

Diagram 5.6
(BP Port Setup for 760-MA)

- 1) Remove adapter
- 2) Secure Festo adapter (6mm) to the Barometer sensor calibration port

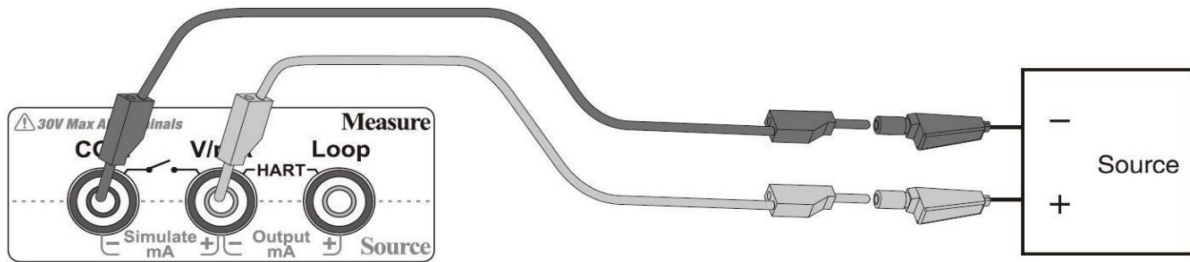

Diagram 5.7
(Current/Voltage Measurement Setup)

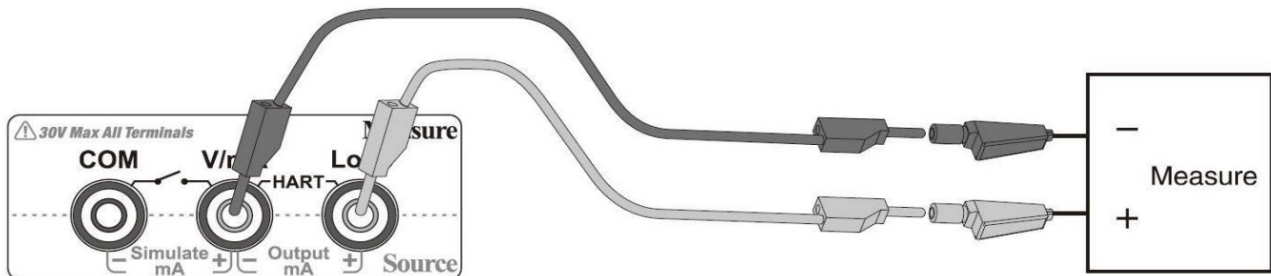



Diagram 5.8
(Current Output Setup)

6.0 – Calibration Procedure

6.1 – Date & Time

- 1) Press the **Power button** to turn the unit on.
- 2) Press the  (top right of the display) to open the options menu.
- 3) Press **Setup** to enter the system settings interface.
- 4) Press **Personalization** to customize certain features.
- 5) Press **Date & Time** to view the following parameters: Time, Date, Date Format, and Date Separator.
- 6) If necessary, use the touchscreen display to adjust any of the Date & Time parameters.
- 7) Press the **Back icon** (top left of the display) repeatedly to return to the main display.

6.2 – Exercise & Zero

6.2.1 – Exercise

- 1) Connect the unit to the appropriate pressure system and ensure that all connections are sealed to prevent any pressure leakage. Refer to Diagram 5.5 for the Pressure Connection Ports of different models.
 - NOTE: Please ensure that all equipment is rated to handle the maximum pressure of the unit under test.
- 2) Pressurize the system to the lower limit range of the unit and allow it to stabilize for a sufficient amount of time. Additel typically allows 60 seconds of stabilization time.
- 3) Pressurize the system to the upper limit range of the unit and allow it to stabilize for a sufficient amount of time.
- 4) Repeat the lower and upper limit exercise for an additional two cycles then vent the system when done.

- 5) If the unit is unstable controlling pressure or is slow to achieve the target pressure, try running the Auto Tune function under the Calibration options. To access Auto Tune, proceed to  > Setup > Services > Calibration > Input 123456 password > Auto Tune. Repeat the lower and upper limit exercise cycles after the Auto Tune is complete.

6.2.2 – Zero



- 1) Vent the system for a sufficient amount of time to allow any trapped gas to escape.
- 2) Press the  at the top right of the main pressure display. Press the **Zero icon** from the drop-down options to manually zero the unit before pressure verification.
 - The unit should not be zeroed when in absolute pressure mode because doing so will add an offset to the test values.

6.3 – Pressure Verification

- 1) Connect the Unit Under Test - UUT (ADT760) to the appropriate pressure system.
- 2) Ensure that the correct reference standards are being used for an acceptable TUR and the system is sealed properly in order to prevent any leakage.
- 3) Determine the test points for the appropriate range.
 - **Compound Pressure – CP** typically has 11 test points:
(-13psi, -7.25psi, 0%, 25%, 50%, 75%, 100%, 75%, 50%, 25%, 0%) max range,
Example: CP100 test points are (-13, -7.25, 0, 25, 50, 75, 100, 75, 50, 25, 0) psi
 - **Differential pressure – DP** typically has 9 test points:
(-100%, -75%, -50%, -25%, 0%, 25%, 50%, 75%, 100%) max range
Example: DP100 test points are (-100, -75, -50, -25, 0, 25, 50, 75, 100) inH2O

- 4) Source the correct amount of pressure for each test point.
- 5) Allow appropriate time for each test point to stabilize and record each measured value.
- 6) Compare the reference and UUT test values. Additel recommends maintaining less than 50% of the tolerance limit.

6.4 – Calibration Adjustment

- 1) Press the  to open the options menu.
- 2) Press **Setup** to enter the system settings interface.
- 3) Press **Services** to open the service options.
- 4) Press **Calibration** and input the Calibration Password as 123456. Press the **Check icon** (top right of the display) to confirm.
- 5) Press the  to view the Calibration Points and previous calibration date, if any, for the internal pressure module.
- 6) CP and DP ranges have 3 calibration points: lower limit, zero, and upper limit.
- 7) Determine and edit the Calibration Points, if needed, using the touchscreen display.
- 8) Select **External Pressurizing** and press the **Play icon** (bottom right of the display) to begin the pressure calibration.
- 9) The display will show three columns: Calibration Points, References and Measured Pressures.
- 10) The lower limit row will be highlighted. Source the lower limit pressure and allow enough time to stabilize. If necessary, adjust the Reference for the lower limit using the touchscreen display. Press the **Next icon** (bottom right of the display) to confirm the lower limit calibration.
- 11) Repeat step 10 for the zero and upper limit calibration points.
- 12) Press **OK** to save the calibration data.

13) Press the **Back icon** repeatedly to return to the main pressure display.

14) Repeat the Zero procedure (6.2.2) and Pressure Verification (6.3).



6.5 – Barometer Verification (NOTE: for ADT760-MA models only)

- 1) Connect the unit's Barometer (BP) port to the appropriate barometer pressure system using a blue Festo hose (6mm). Refer to Diagram 5.6 for the BP Port Setup.
- 2) To access the unit's BP reading, proceed to  > Setup > Control Settings > Running Information > Atmosphere.
- 3) Determine the test points for barometric pressure – BP testing. Additel typically uses 4 test points for BP testing: (60, 80, 100, 110) kPa.a
- 4) Source the correct amount of pressure for each test point.
- 5) Allow appropriate time for each test point to stabilize and record each measured value. Additel sets the barometric test tolerance at $\pm 55\text{Pa}$.
- 6) Compare the reference and UUT test values. Additel recommends maintaining less than 50% of the tolerance limit.

6.6 – Barometer Calibration (NOTE: for ADT760-MA models only)

- 1) From the main pressure display, press the unit of measurement and change it to **kPa**.
- 2) Press the  to open the options menu.
- 3) Press **Setup** to enter the system settings interface.
- 4) Press **Services** to open service options.
- 5) Press **Calibration** and input the Calibration Password as 123456. Press the **Check icon** to confirm.
- 6) Press **Barometer** and select **Multi Point Calibration**.
- 7) The display will show three columns: Calibration Points, References, and Measured Pressures. A date will also be displayed if a previous calibration has been performed.
- 8) Determine and edit the calibration points column, if necessary, using the touchscreen display. Barometer typically has two calibration points: 60kPa.a for the lower limit and 110kPa.a for the upper limit.
- 9) Press the **Play icon** to begin the BP calibration procedure.
- 10) The lower limit row will be highlighted. Source the lower limit pressure and allow enough time to stabilize. If necessary, adjust the Reference for the lower limit using the touchscreen display. Press the **Next icon** to confirm the lower limit calibration.
- 11) Repeat step 10 for the upper limit calibration.
- 12) Press **OK** to save the calibration data.
- 13) Press the **Back icon** repeatedly to return to the main pressure display.
- 14) Vent the system and repeat the Barometer verification (6.5).

6.7 – Electrical Verification

- 1) Connect the UUT (ADT760) to the appropriate electrical system. Ensure that the wires are plugged in correctly to test DC Voltage, DC Current, Output Current, or 24V DC Output. Refer to Diagrams 5.7 and 5.8 for the correct electrical setup.
- 2) Determine the test points for each type of electrical test.
 - **DC Voltage** typically has 7 test points: (-30, -10, -5, 0, 5, 10, 30) V
 - **DC Current** typically has 7 test points: (-30, -10, -5, 0, 5, 10, 30) mA
 - **Output Current** typically has 4 test points: (0, 4, 12, 24) mA
 - **24V DC Output** typically has 1 test points: 24V
- 3) DC Voltage, DC Current, or Output Current can be selected by pressing the **mA** or **V** icon/range at the top left corner of the main electrical display and changing the function. 24V DC Output can be toggled ON/OFF by accessing  > Setup > 24V Power.
- 4) When testing DC Voltage or DC Current, press the  at the top right of the main electrical display. Press the **Zero icon** from the drop-down options to manually zero the unit before electrical verification.
- 5) Source the correct amount of voltage or current for each test point.
- 6) Allow appropriate time for each test point to stabilize and record each measured value.
- 7) Compare the reference and UUT test values. Additel recommends maintaining less than 50% of the tolerance limit.

6.8 – Electrical Calibration

- 1) Press the  to open the options menu.
- 2) Press **Setup** to enter the system settings interface.
- 3) Press **Services** to open service options.
- 4) Press **Calibration** and input the Calibration Password as 123456. Press the **Check icon** to confirm.
- 5) Press **(-30~30) mA** to calibrate DC Current. Ensure that the electrical system is wired to measure current.
- 6) The display will show two columns: Calibration Points and Measured Values. DC Current typically has 3 calibration points: lower limit (-30mA), zero (0mA), and upper limit (30mA). Adjust the calibration points, if necessary, using the touchscreen display.
- 7) Press the **Play icon** to begin the current calibration.
- 8) The lower limit row will be highlighted. Source the lower limit current and allow enough time to stabilize. Press the **Next icon** to proceed.
- 9) Repeat step 8 for the zero and upper limit current calibration points.
- 10) Press **OK** to save the DC Current calibration data.
- 11) Press **(-30~30) V** to calibrate DC Voltage. Ensure that the electrical system is wired to measure voltage.
- 12) The display will show two columns: Calibration Points and Measured Values. DC Voltage typically has 3 calibration points: lower limit (-30V), zero (0V) and upper limit (30V). Adjust the calibration points, if necessary.
- 13) Press the **Play icon** to begin the voltage calibration.
- 14) The lower limit row will be highlighted. Source the lower limit voltage and allow enough time to stabilize. Press the **Next icon** to proceed.

- 15) Repeat step 14 for the zero and upper limit voltage calibration points.
- 16) Press **OK** to save the DC Voltage calibration data.
- 17) Press **(0~24) mA** to calibrate Output Current. Ensure that the electrical system is wired to output current.
- 18) The display will show two columns: Calibration Points and Measured Values. Output Current typically has 3 calibration points: zero (0mA), lower point (1mA), and upper limit (24mA). Adjust the calibration points, if necessary.
- 19) Press the **Play icon** to begin the output current calibration.
- 20) The zero point will be highlighted and the unit will source the zero current to the readout device. Allow enough time to stabilize. Using the touchscreen display, adjust the Measured Value to match the value of the readout device. Press the **Next icon** to proceed.
- 21) Repeat step 20 for the lower and upper limit output current calibration points.
- 22) Press **OK** to save the Output Current calibration data.
- 23) Press the **Back icons** repeatedly to return to the main electrical display.
- 24) Repeat the Electrical Verification (6.7).