

WÖHLER

Operation Manual Combustion Analyzer

Wohler A 450 Wohler A 450 L



Best.-Nr.24074 – 2024-04-24

The Measure of Technology

1.800.561.8187

www.**itm**.com

information@itm.com

Contents

1	General Information.....	5
1.1	Operation Manual Information.....	5
1.2	Notes.....	5
1.3	Intended Use.....	5
1.4	Basic features	6
1.5	Transport and stocking.....	6
1.6	Information on disposal	7
1.7	Manufacturer	8
1.8	Important information	8
2	Application and functionality	9
3	Specifications.....	10
3.1	Readings	10
3.2	Calculated Values	12
3.3	Technical Data	13
5	Component Explanation	14
5.1	Probes, sensors and filters.....	16
5.2	Display	18
5.3	Gas sampling path Wohler A 450.....	19
6	Getting started	20
6.1	Activating the battery.....	20
6.2	Tightness test.....	20
6.3	Charging the battery.....	21
6.4	Connecting the flue gas probe	22
7	Using the Analyzer.....	23
7.1	Turning the analyzer on and off.....	23
7.2	Calibration	23
7.3	Measuring	25
7.3.1	Readings screen	25
7.3.2	Selecting the fuel.....	27
7.3.3	Setting the fuel parameters	27
7.3.4	Options.....	28
8	Readings Menu	31

8.1	Delete data	31
8.2	Print data	31
8.3	Save data in the customer menu.	32
8.4	Save data with the "Quick save" option	33
9	Menu	33
9.1	Device data.....	34
9.2	Ambient CO	35
9.3	Manifold Pressure.....	35
9.4	Temperature Measurement.....	37
9.5	Tuning Guide	38
9.6	SETUP.....	39
9.6.1	Option "Date".....	40
9.6.2	Option "Time".....	40
9.6.3	Option "Date format"	40
9.6.4	Option "Time format"	40
9.6.5	Option "Brightness".....	40
9.6.6	Option "Buzzer"	40
9.6.7	WLAN configuration.....	40
9.6.8	Option "Quick save"	44
9.6.9	Option "Customer by"	44
9.6.10	Option "Device by".....	44
9.6.11	NO _x calculation	44
9.6.12	Filter warning	44
9.6.13	Signals.....	44
9.6.14	Customer Logo	45
9.7	Calibration	45
10	Customer data	45
10.1	Set up a new customer	46
10.2	Save records.....	46
10.3	Search function : customer, system, customer number, device number.....	47
10.4	New customer.....	49
10.5	Delete customer.....	49
10.6	Delete all.....	49
11	Data exchange with the PC.....	49

12	Troubleshooting.....	49
13	Maintenance	50
13.1	Maintenance work	50
13.2	Removing condensate.....	51
13.3	Changing the filters	53
13.3.1	Cotton filter.....	53
13.3.2	Water stop filter	53
13.4	Sensor diagnosis and replacement	54
13.5	Replacing the battery	61
13.5.1	Replacing the battery	61
14	Six-monthly check	62
15	Guaranty and Service	62
16	Declaration of conformity	64
17	Accessories.....	66

1 General Information

1.1 Operation Manual Information

This operation manual allows you to work safely with the Wohler A 450. Please keep this manual for your information.

The Wohler A 450 should be employed by professionals for its intended use only.

Liability is void for any damages caused by not following this manual.

1.2 Notes



WARNING!

Not following this warning can cause injury or death.



ATTENTION!

Not following this note can cause permanent damage to the device.



NOTE!

Useful information

1.3 Intended Use

Use the Wohler A 450 for combustion analysis and control of heating appliances and for the measurement of wood moisture.

The analyzer should be used indoors only.

The Wohler A 450 is not suitable for continuous operation.

It takes about 3 minutes to take a typical measurement.

1.4 Basic features

Device	Basic equipment
Wohler A 450 with WiFi. USB- and IR port	Probe and hose assembly with 1,5 m hose
	Ambient Temperature Probe
	Charger with micro-USB-cable
	Li-Ion Battery

1.5 Transport and stocking Improper transport can harm the instrument.

- Always transport the analyzer in the provided carrying case in order to prevent damage.



ATTENTION!

Only store and transport the analyzer with the condensate trap inserted and cleaned to prevent dirt from getting inside the analyzer.

When storing and transporting the unit in the case, the gas hose must be connected to the condensate trap. Otherwise, condensate from the hose can enter the unit. There is a risk of damage to the unit.

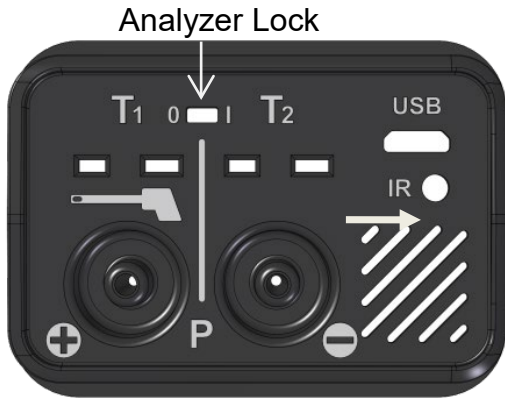

Fig. 1: Transport lock at the bottom of the analyzer

! ATTENTION!

For the transport deactivate the battery with the transport lock.

The locking switch is located on the connection plate at the bottomside of the device.

- Deactivate the battery by pushing the transport lock to the left to the “0” with a pointed object (wire or pen).
- Activate the battery by pushing the transport lock to the right to the “I”.

When the instrument is delivered, the battery is always deactivated.

1.6 Information on disposal



Electronic equipment does not belong into domestic waste, but must be disposed in accordance with the applicable statutory provisions.

You may hand in any defective batteries taken out of the unit to our company as well as to recycling places of public disposal systems or to selling points of new batteries or storage batteries.

1.7 Manufacturer

1.8 Important information

! **ATTENTION!**

In order to ensure the quality of the application and the measurement result, the analyser may only be used with original Wohler accessories and original Wohler spare parts. This applies in particular to legally regulated measurement tasks

! **ATTENTION!**

Do not expose the instrument to moist flue gas, if it has been exposed to temperatures below 0°C for a certain time. This may harm the instrument.

! **ATTENTION!**

The instrument is equipped with strong magnets to fix it during the measurement. The magnetic field may harm heart pacemakers, hard disks, data mediums, magnetic stripe cards, controls etc. Keep sufficient distance to magnet-sensitive objects.

! **ATTENTION!**

Occasional measurements on cogeneration units (maximum 50 measurements) are permitted due to an internal NO_x-filter. If you do measurements on cogeneration units more frequently, please use the external Wohler CHP-Filter, see accessory.

When measuring in flue gases of a cogeneration unit, the NO_x concentration might be multiple times higher, than in the flue gases of a typical small-scale furnace. An early loss of the cross-insensitivity of the CO-sensor on NO_x is perceived as an overload and therefore not covered by your warranty.

2 Application and functionality

The Analyzer Wöhler A 450 with CO-Sensor 10,000 ppm meets the requirements of ANSI/BPI-1200-S-2017:

1. The Wöhler A 450 is capable of measuring, and displaying digitally, carbon monoxide (CO) levels from 0 to 10,000 ppm.
(requirement ANSI/BPI-1200-S-2017: 0 to 2,000 ppm).
2. The Wöhler A 450 is capable of calculating and displaying digitally, CO air free concentrations, and has digital displays of CO as measured and O₂ levels to allow manual calculation of CO air free.
3. The Wöhler A 450 has a resolution of 1 ppm CO.
4. The Wöhler A 450 has an accuracy of $\pm 5\%$ of reading or ± 10 ppm, whichever is greater.
5. The CO Sensor of the Wöhler A 450 is equipped with a nitric oxide filter (NO_x filter).
6. The Wöhler A 450 is calibrated in accordance with the manufacturer's recommendations with available documentation traceable to the individual device.

3 Specifications

3.1 Readings

Oxygen (O ₂) concentration in flue gas	
Display	Volume % referenced to dry flue gas
Measurement principle	electrochemical sensor
Range	0.0 to 21.0 %
Accuracy	± 0.3 Vol. -%
Carbon monoxide (CO _v 10,000 ppm) in flue gas (only Wohler A 450)	
Display	Volume ppm referenced to dry flue gas
Measurement principle	Electrochemical sensor, not H ₂ compensated
Range	0 to 10,000 Vol. ppm, resolution 1 Vol.-ppm
Accuracy	± 10 ppm (< 200 ppm), otherwise 5 % of reading
Carbon monoxide (CO _v 5,000 ppm) in flue gas (only Wohler A 450 L)	
Display	Volume ppm referenced to dry flue gas
Measurement principle	Electrochemical sensor, not H ₂ compensated
Range	0 to 5,000 Vol. ppm, resolution 1 Vol.-ppm
Accuracy	± 40 ppm (< 400 ppm), otherwise 10 % of reading

Nitric oxide concentration (NO_v) in flue gas (optional)

Display	Volume ppm referenced to dry flue gas
Measurement principle	electrochemical sensor
Range	0 to 3,000 vol. ppm, resolution 1 vol. ppm
Accuracy	±5 vol. ppm (<100ppm), otherwise 5 % of reading

Chimney draught / differential pressure (PD)

Display	Pascal
Measurement principle	Semi-conductor diaphragm
Range	0.00 to ± 110.00 hPa, resolution 1 Pa
Accuracy	2 Pa (< 40Pa), otherwise 5% of reading

Flue gas temperature (TS)

Display	°F
Measurement principle	Thermocouple (NiCr-Ni)
Range	68-1472 °F
Accuracy	0 – 271.4 °F: ± 35,6 °F; 271.4-1472 °F: ± 1.5% of reading

Combustion air Temperature (T_A)

Display	Fahrenheit
Measurement principle	Thermocouple (NiCr-Ni)
Range	68 °C to 212 °F
Accuracy	± 1°F

3.2 Calculated Values

Calculated Value	Explanation
Efficiency /SL	Efficiency and losses in accordance to ASME standards
ETA/QS	Efficiency and losses in accordance to European standards (0.0 to 120%)
CO ₂ in Vol. -%	Range 0 – CO _{2max} , resolution 0.1 %
Dpt	°C Dew Point in the flue gas
Medium soot level	Soot number ± 0.1
Excess air coefficient	Lambda λ (e.g. 1,25 when the excess of air is 25%)
C _{on}	Condensate quantity in condensing conditions
Toxication index GI	CO/CO ₂
Air velocity	0.1 to 130 m/s, resolution < 0.1 m/s, for the measurement of the ventilation loss (heating check)

3.3 Technical Data

Description	Data
Power supply	Lithium-Ion, rechargeable battery 3.7 V, 2,250 mAh, charges via USB
Battery Operating time	Approx. 6 h (depends on operating status and display illumination)
Charging time for a full charge	Approx. 3 hours
Storage Temperature	4-122 °F
Operation temperature	41-104°F
Weight	1.5 lbs
Dimensions	6 x 4 x 1.5 inches
Length of the probe-hose	5 ft

5 Component Explanation



Fig. 2: Front view of the analyzer

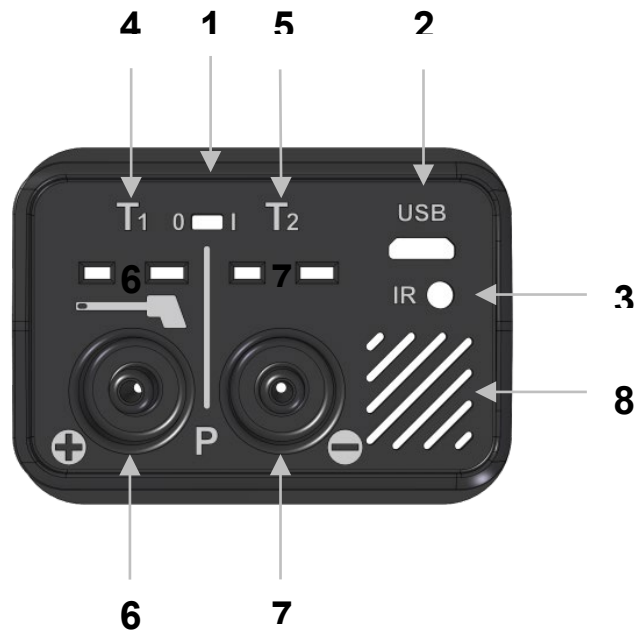

Fig. 3: Connection plate on the bottom of the unit

Connections on the bottom of the unit

- 1 Lock Battery, cf. chapter 6.1
- 2 USB-port for data transfer and charging
- 3 IR interface for thermal printer
- 4 Gas temperature
- 5 Ambient Air Temperature
- 6 Positive pressure
- 7 Negative pressure
- 8 Speaker for alarm signals

5.1 Probes, sensors and filters



NOTE!

The following probes and filters have to be purchased as accessories.



S-tube probe for measuring the flow speed with adapter

Fig. 4: S-tube probe



Flexible capillaries for the 4 PA test (an adapter is needed)

Fig. 5: Flexible capillaries



If you frequently do measurements on cogeneration units, please use the external Wohler CHP-Filter, that has to be attached to the probegrip Wohler A 450. Occasional measurements on cogeneration units (maximum 50 measurements) are permitted because the analyzer disposes of an external NO_x-filter

Fig. 6: Probegrip with CHP-Filter



Ambient Temperature Plug

Fig. 7: Ambient Temperature Plug



Combustion air temperature probe Wohler A 450 ,
185 mm

Fig. 8: combustion air temperature probe

Hoses for pressure measurement



Fig. 9

5.2 Display

The Wohler A 450 is operated via Touchscreen. The measurement menu is similar to the one of a smartphone. A fingertip on the icon starts the correspondent measurement mode. The active icons are graphically emphasized.

If there is a bar on the right of the display, the display can be scrolled by pulling it with the finger.

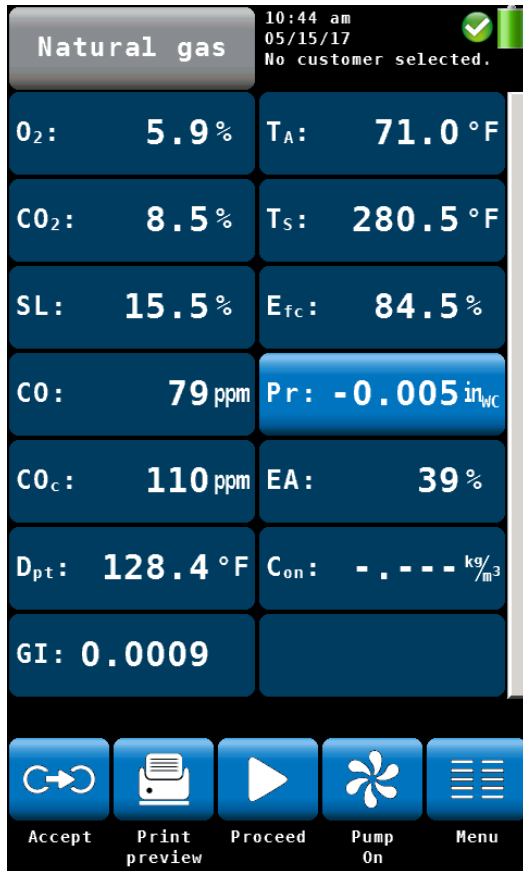

Fig. 10: Display details

The display is divided into different segments:

The fuel is shown in the topline on the left. The currently selected customer and measurement mode are shown on the right of the fuel.

Date and time, system diagnostic status and battery level are shown on the right.

The readings segment displays the current readings.

Click on P_R key for zeroing the pressure sensor.

NOTE!

The user can set up the display according to his needs. He can arrange the readings and chose the units. Go to the setup-menu and select "change units" (see chapter 9.6).

The icon segment offers different options. These options are explained in chapter 7.3.1

5.3 Gas sampling path Wohler A 450

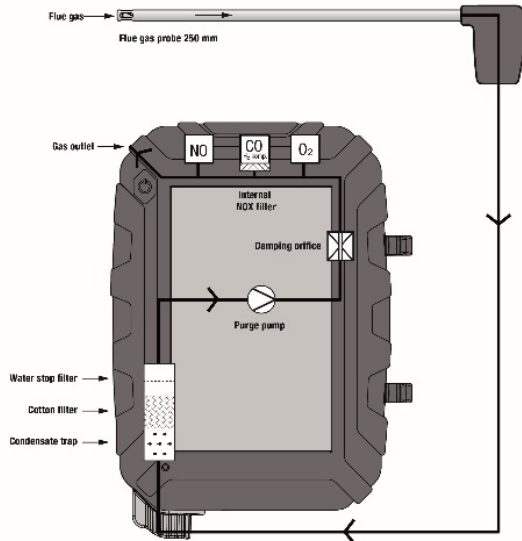

Fig. 11: Gas sampling path Wohler A 450 with flue gas probe 250 mm

The sensors are protected against condensate by a three-step-filter conditioning:

The first step is the coarse filter in the probe handle. Most of the particles will be removed from the sample. After that the gas passes the condensate trap, where the gas is cooled by a spiral and the condensate is collected.

The second step is an exchangeable cotton filter. Fine particles and rests of water will be removed from the sample.

The last step is the Water Stop Filter. This filter will not allow any kind of moisture to pass. The filter will clog automatically in contact with water, so that the sensors are protected against moisture.

The flue now passes each sensor module (O₂, CO and NO). During this process, the CO-sensor is additionally protected by the internal NO_x filter.

6 Getting started

6.1 Activating the battery



Fig. 12: Battery lock to the right: Battery activated; Battery lock to the left: Battery locked

- **Before first use:** Activate the battery by pushing the battery lock with a sharp object (paper clip or other slim wire) to the right, cf. adjacent figure.

The locking switch is located on the connection plate at the bottom of the unit.

6.2 Tightness test

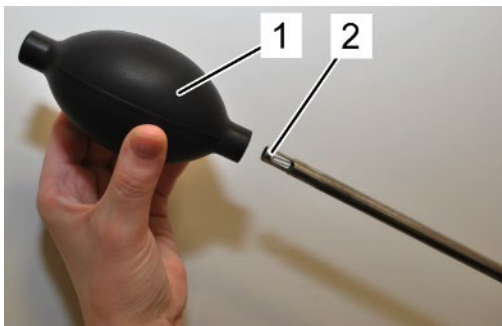

Fig. 13: Ball pump

Before the tightness test connect the gas probe. Proceed as follows:

- Squeeze the ball pump (part 1).
- Plug the ball pump (part 1) on the gas probe (part 2)
- Release the ball pump.

After the ball pump has been released, it may not fill with air or only fill very slowly. Otherwise the connection is not tight.



ATTENTION!

Never plug the ball pump on the gas probe and squeeze it afterwards. In this case the draft probe will be damaged.

6.3 Charging the battery



Fig. 14: USB port

The battery indication is displayed in the upper right corner of the screen. A fully charged battery is shown as a solid green battery symbol.

If the battery symbol is red, the display illumination is automatically reduced to save energy. In this case, charge the battery or use the Wohler A 450 in mains operation.

- Before you plug the USB-recharger into the outlet, connect it with the analyzer. To do so, plug the USB connector of the recharger to the USB port at the bottom of the analyzer.

During the charging process a jack-symbol will blink in the upper right part of the screen and the ON/OFF key will blink red.



NOTE!

Recharging empty batteries can take up to 7 hours. You can still go on measuring while battery charging is in progress. In this case charging time will be longer.

After the charging time has finished the ON/OFF key will shine red.



WARNING!

Risk of electrical shock!

Never touch the power supply with wet hands!
Protect the power supply against water and moisture!

Do not unplug the recharger by pulling the cable!

Do not use the power supply when the voltage requirements of the recharger and the supply do not match!

6.4 Connecting the flue gas probe



- Attach the wide gas hose to the gas connection (1)
- Attach the small gas hose to the positive pressure connection (2) .
- Attach the temperature plug to the temperature connection T₁ (3). Please observe the correct polarity.

Fig. 15: Bottom of the device

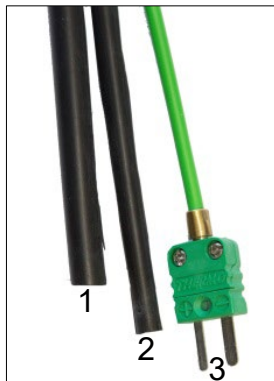

Fig. 16: Gas probe – gas hose (1), pressure hose (2), temperature plug (3)

7 Using the Analyzer



ATTENTION!

Before use, always test if the instrument is in a proper condition. Perform a tightness test according to chapter 6.2.

7.1 Turning the analyzer on and off

- Press the ON/OFF key shortly to turn ON the analyzer. The startup screen will appear.
- Long press the ON/OFF-key for 3 seconds to turn the analyzer off.

7.2 Calibration

Immediately after the device has been switched on, the Wohler A 450 will start to calibrate the sensors with fresh air. This calibration process will take 60 sec.



Note!

The gas probe may not be located in the flue gas tube during the calibration.

During the calibration process 5 icons will appear in the display.

- Click on an icon to open the correspondent menu.



Fig. 17: Sensor calibration

Restart



Starts the calibration again.

Diagnosis



Click on the "diagnosis" icon to finish the hotspot search and enter the analyzers self diagnosis mode (see chapter 0).

Customers



Click on the "Customers" icon to enter the Customers menu. The Customers Menu allows to set up a new customer or preselect a customer before the measurement. After the measurement the measured data can be stored to the customer folder, see chapter 8.3.

Data Exchange



Click on the "Data Exchange" icon to finish the hotspot search and enter the data exchange mode. In this mode data can be exchanged between the Wohler A 450 and the PC via USB or Bluetooth.

Menu



Opens the main menu. Only those submenus are available which can be started without hotspot search.

7.3 Measuring

After the 60 seconds calibration procedure the analyzer will display the main combustion efficiency test screen.

7.3.1 Readings screen

All readings (measured and computed values) will be shown continuously in the readings segment.



NOTE!

The user can change the order of the values. He can also select the unit of some of the values (see chapter 9.6) Up to 14 values can be shown on screen. The following screen is only an example.

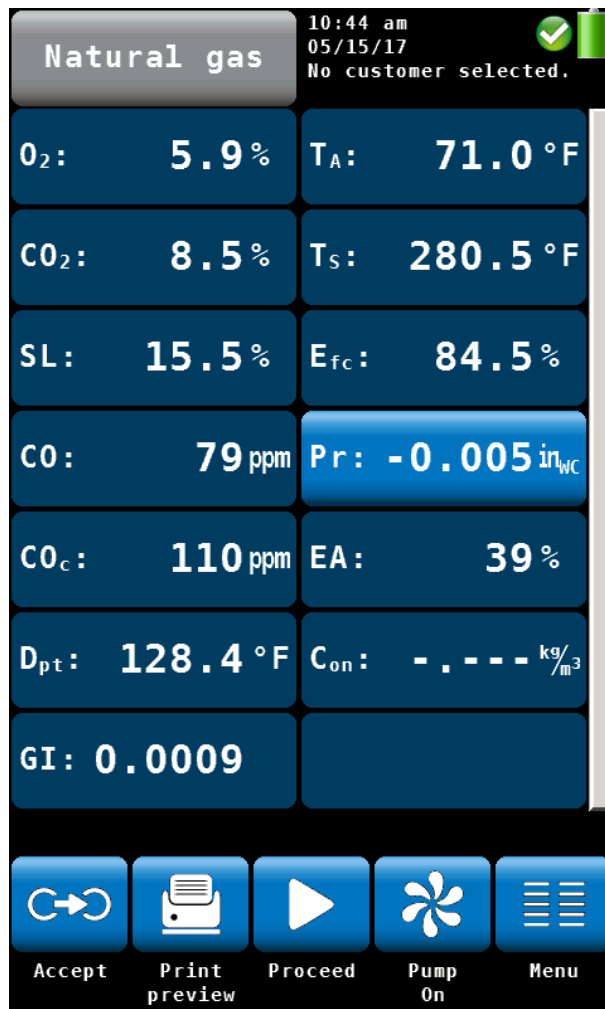

Fig. 18: Readings segment

Using the Analyzer

	Possible units	Measured and computed values:
O ₂	Vol.-%	Oxygen content
CO ₂	Vol.-%	Carbon dioxide content
Q _s	%	Flue gas loss
CO	ppm; mg/m ³	Carbon monoxide, referred to dry flue gas, diluted value
CO _c	ppm, mg/m ³ , mg/kWh, mg/MJ	Carbon monoxide, corrected (air free)
C _{on}	kg/m ² or kg/kg (depending on the fuel)	Condensate qty. in condensing conditions
NO	ppm, mg/m ³	Nitrogen oxide
NO _c	ppm, mg/m ³ , mg/kWh, mg/MJ, lbs/mmbtu, g/GJ	Nitrogen oxide, corrected (air free)
D _{pt}	°C/°F	Dew Point
GI	--	Toxication index CO/CO ₂
T _A	°C/°F	Ambient Temperature
T _s	°C/°F	Flue Gas Temperature
η	%	Eta, Efficiency and losses calculated in accordance to EN standards
Efficiency /SL	%	Efficiency and losses in accordance to ASME standards
ETA/QS	%	Efficiency and losses in accordance to European standards (0.0 to 120%)
Pr	Pa, hPa, mbar, mmH ₂ O, inwc, psi	Differential Pressure
λ	--	Theoretical air/ excess air
EA	%	Excess air

7.3.2 Selecting the fuel



Fig. 19: Fuel options

The selected fuel is shown in the topline on the left of the readings screen.

- Click on the fuel key to enter the fuel options menu.

Optional fuels as below:

Natural gas, Fuel Oil 2, Fuel Oil 4, Fuel Oil 6, Bio-fuel, LPG, Propane, Kerosene, Digester Gas, Coal, Wood, Pellets and four user defined fuels



NOTE!

To see all fuels scroll by drawing your finger over the screen.

- Click on a fuel. The fuel will be selected for the next measurement.
- After turning off and on the analyzer, the last selected fuel will be active again.

7.3.3 Setting the fuel parameters

The reference oxygen and the Lamda threshold values of all fuels can be individually set.

All parameters can be set for the user defined fuels.

- Click on the “Fuel data” icon to control or change the fuel parameters. The “Fuel data” icon will turn green.
- Click on the fuel whose parameters are to be changed.
- The analyzer enters the fuel parameter menu. Change the parameters and confirm with "OK".

7.3.4 Options

Graph

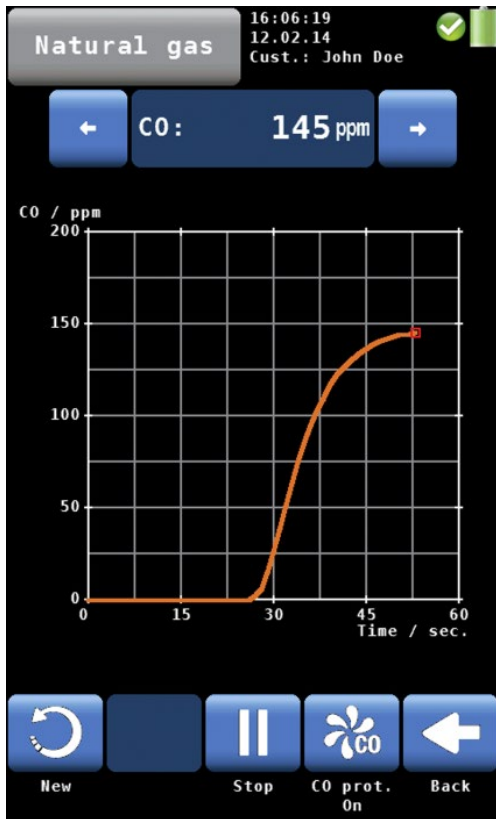

Fig. 20: Graph of the CO readings

Copy readings



Clipboard readings



In the **readings screen** a click on one of the icons at the bottom offers the following options:

- A click on the Graph icon generates a graph of the measured values.
- Above the graph the measured value, which is presented in the graph, is indicated as a number.
- Select the value to be presented with the arrow keys.

The options in the graph mode are as follows:

- Click **New** to start a new measurement.
- Click **Stop** to stop the measurement and hold the values.
- Click **Back** to return to the numeric screen.

- Click on the “Copy readings” icon to copy the readings into the clipboard. The “Copy val-readings” icon will appear in the top right screen.

This way the user can save the readings in case of an early switching off of the burner. When the user continues the measurement after having copied the readings to the clipboard, he can decide if he wants to save the actual readings or those of the clipboard.

- To save the readings of the clipboard, stop the measurement. When the measurement is stopped click on "Clipboard readings".

In the clipboard screen, the "Current readings"

icon will appear.

Current readings



Stop



Print



Send Report



NOTE!

A click on the "current readings" icon enters the current readings screen. A click on the "Clipboard readings" icon enters the clipboard.

- Click **Stop** to stop the measurement and hold the values. The sample pump continues.
- or
- Press the Start/Stop button of the probe handle to stop the measurement and hold the values. (The sample pump continues.)



NOTE!

Only the Wohler A 450 is equipped with a Start/Stop button.



NOTE

The print symbol only appears in the measurement display if the measurement was stopped with the stop button and no measurement data are copied to the clipboard.

- Tap on the print symbol to print the currently displayed measurement data on the Wöhler TD 100 thermal printer.

A print preview is shown in the display.

- Tap on the cancel symbol if you do not want to print the data shown above.

-

The "Send Report" icon appears in the print preview. It is only active if the measuring device is connected to the Wöhler A 450 app and the "Device connected" page appears there.

- Press the "Send Report" button to send the printer protocol as PDF to the app. It can be signed and sent by hand in the app in the display.

Pump off

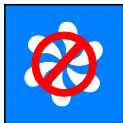

Pump on



Accept



Proceed



- Click on "Pump OFF" to turn off the gas pump and the CO protection pump.

- Click on "Pump on" to turn on the gas pump.

The "Accept" icon will only appear if the measurement is stopped.

- Click on the "Accept" icon to enter the Readings menu.

In the Readings menu you can save the readings in a customer folder (see chapter 8).

- Click on "Proceed" to continue the measurement.

8 Readings Menu

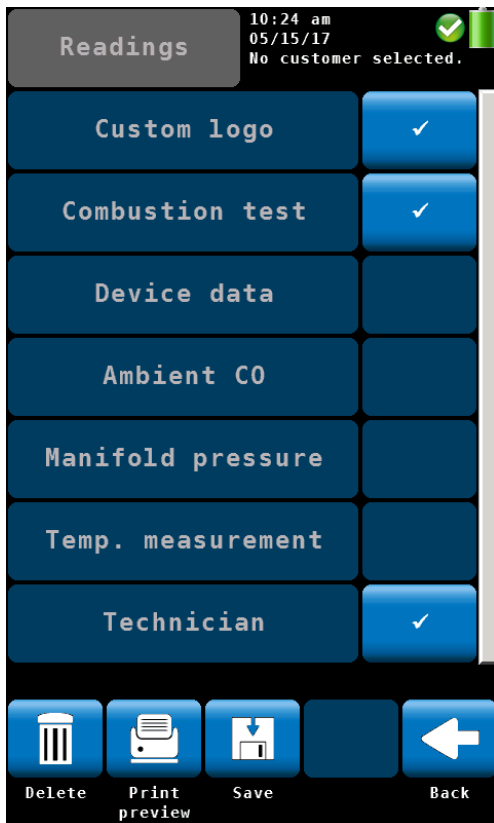

Fig. 21:Readings Menu

If the user accepts a record, the analyzer will enter the readings menu automatically. It is also possible to enter the readings menu by clicking on the readings icon in the main menu. In the readings menu a list with all possible measurements and tests is shown. Those tests that have already been done will appear with a checkmark. Those tests that have already been saved will be marked by a lock. Select a measurement to delete, print or save it.

"Customer Logo" and "Technician" (last item) will always be marked by a checkmark.

- If you do not want the logo or the technician to appear on the printout, remove the correspondent checkmark. This setting will be saved if you turn the analyzer off and on again.

8.1 Delete data



- Click on the "Delete data" icon to delete the selected data.

8.2 Print data



- Click on the "Print preview" icon to print the selected information on the Wohler TD 100 Thermoprinter.

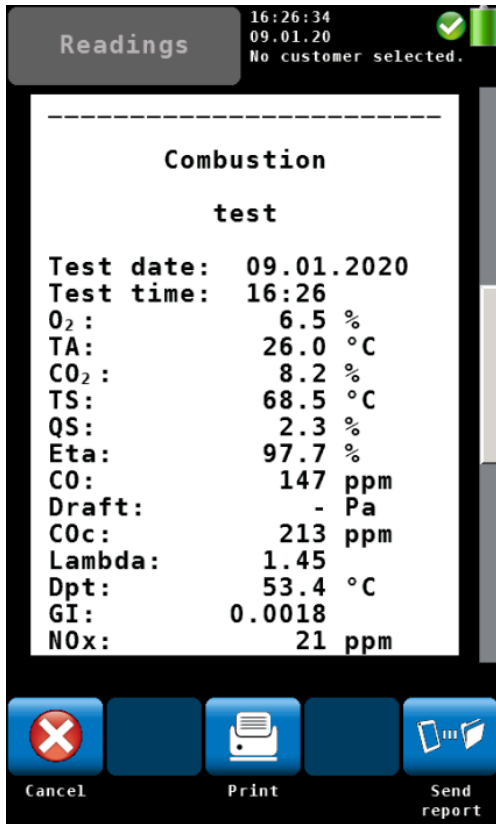

Print Preview

A print preview will appear.

If you are working with the Wöhler A450 app, the "Send report" icon in the print preview will become active as soon as you are on the "Device connected" page in the app. When you click on the icon, the print preview appears in the app. You can sign it there by hand and send it on.

- Click on the "Cancel" icon, if you do not want to print the information shown in the preview
- or
- Click on the "Print" icon to start the printout.



NOTE!

When the measurement is stopped, you can also print the measured values directly from the measuring display without saving them.



Printing the readings of the Wohler A 450 on the Thermoprinter Wohler TD 100.



NOTE!

Place the printer with the IR receiver toward the IR interface of the analyzer.

After printing, the analyzer will enter the measurement mode again.

8.3 Save data in the customer menu.



- Click on the "Save" icon to save a customer record. The analyzer will enter the customer menu. Create a new customer folder or save the record in an existing customer folder.
- Proceed as described in chapter 10.

8.4 Save data with the “Quick save” option

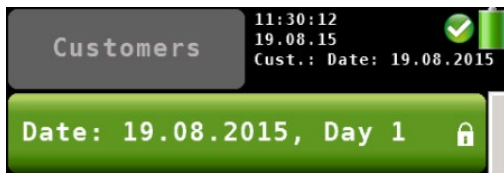

Fig. 22: Data record saved with the quick save function

If the quick save option is activated in the Setup-Menu (see Chapter 9.6), the analyzer will automatically save the measurement records under a new customer. The customer name will be the measurement date and the measurement time.

- After the measurement click on “Accept”.
- Click on the “Save” icon to save a customer record.

9 Menu



- Click on the main “Menu” icon to enter the main menu.

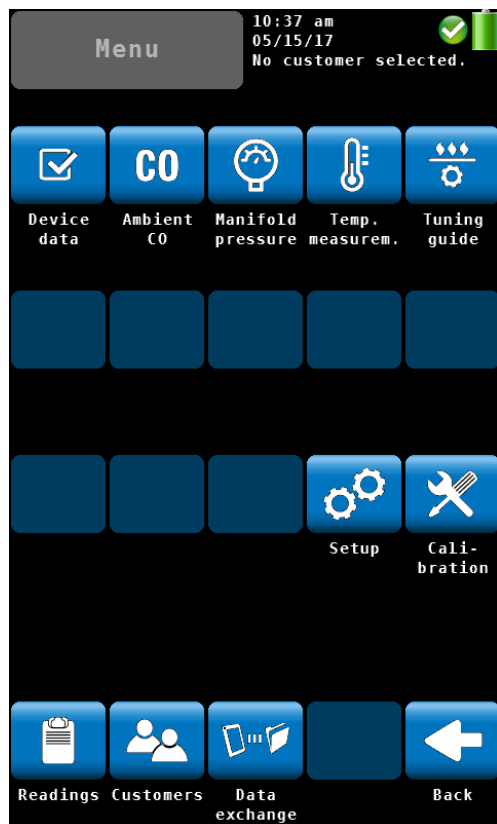

Fig. 23: Main menu

In the main menu you can select the different measurement options or the setup-menu or the calibration menu.

The lower icon bar shows the “Customer” (see chapter 10) and the “Readings” icon (see chapter 8).

- Click on the “Back” icon to return to the normal measurement mode.

9.1 Device data

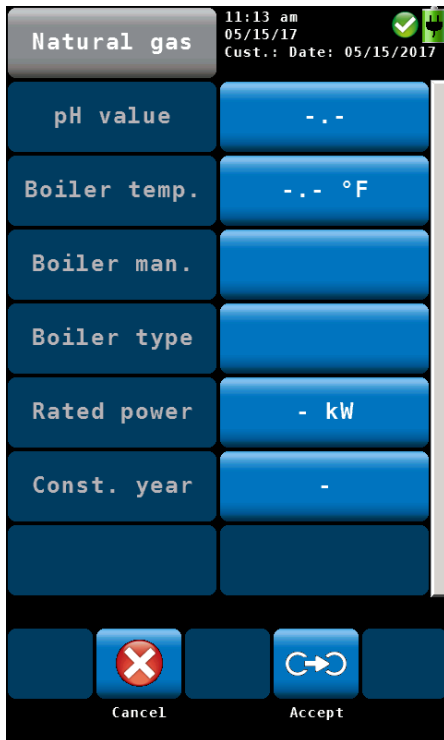

Fig. 24: "Device data" screen

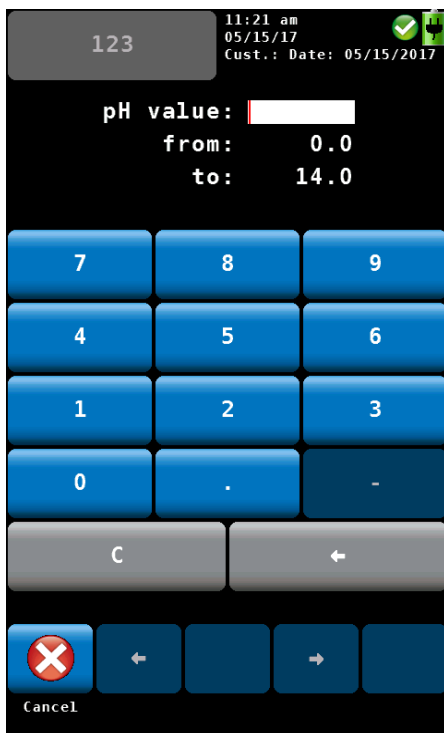

Fig. 25: Entering the pH value

In the "Device data" screen the user can enter information about the heating system. He can save this information together with the readings in the customer folder.

- Select a parameter.

- Enter the correspondent information.
- Press OK to confirm.



NOTE!

The value to be entered must be within the preset limits (in the example on the left between 0.0 and 14.0). If the value is not between the preset limits, it will not be possible to confirm the value.

After confirming the analyzer will automatically return to the device data screen.

- To save the information, proceed as described see chapter 8.



NOTE!

It is possible to save the information about the heating system together with the readings.

9.2 Ambient CO

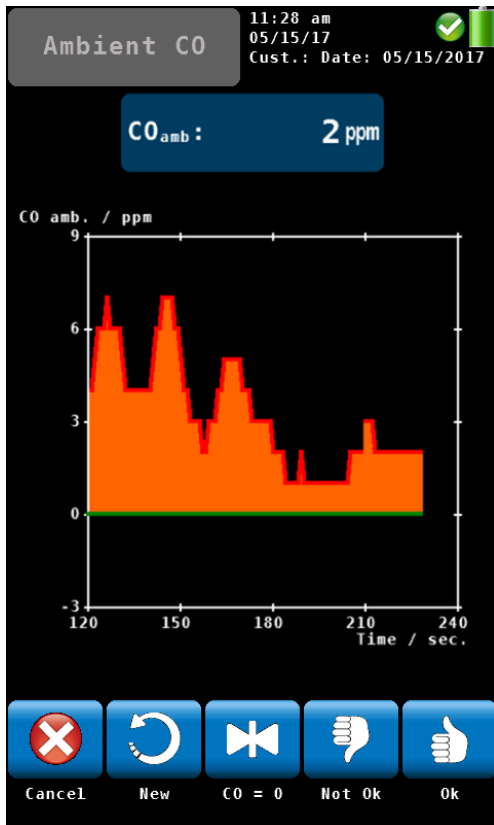

Fig. 26: Ambient CO

The option 'Ambient CO' offers a graphical assisted ambient CO test.

The current ambient CO concentration is shown over the elapsed measurement time. The figure on the left shows an 'Ambient CO' test over a time period of 230 seconds and the current CO level is 2 ppm.

The options during the ambient CO test are as follows:

- Cancel (left icon): click the left key to exit without performing an “Ambient CO” test and return to the main menu.
- New: Start a new “Ambient CO” test
- Option “CO=0”: click to zero-out the CO sensor offset reading.
- To evaluate the test click on "Not OK" or "OK". The analyzer will enter the data menu where you can save and/or print the information.



NOTE!

Due to temperature effects and aging of the CO sensor it is possible that the 0 ppm offset level changes. Check regularly in clean air that the ambient CO level is reading zero. If the reading is not zero in clean air, click the 'CO=0' key to zero-out the readings.

9.3 Manifold Pressure



Fig. 27: Pressure connector

- To perform a manifold pressure test click on the “Manifold Pressure” icon in the main menu screen.
- Connect a pressure hose to the negative Pressure connector at the bottom of the analyzer .

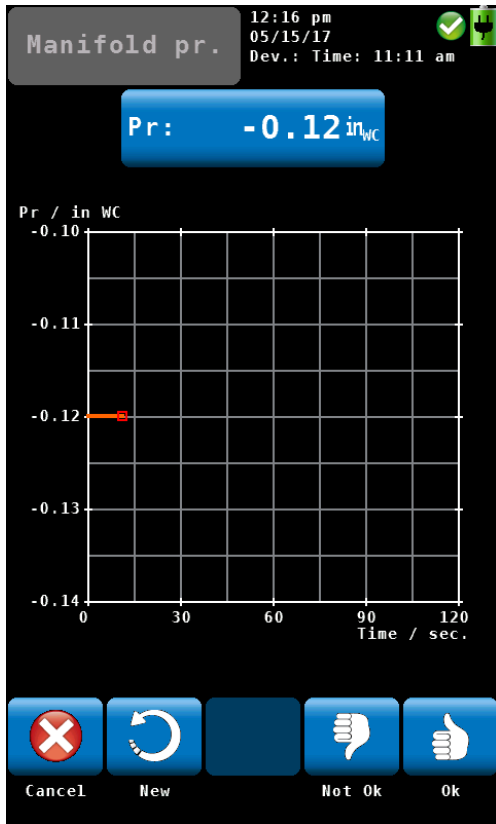

Fig. 28: Manifold Pressure mode screen

The options in the “Manifold Pressure” mode screen are:

- Option “Cancel”: click “Cancel” to exit the “Manifold Pressure” test and return to the main menu.
- Option “New”: click “New” to clear the graph and all captured readings and start a new “Manifold Pressure” test.
- To evaluate the test click on “Not OK” or “OK”. The analyzer will enter the data menu where you can save and/or print the information.

9.4 Temperature Measurement

- To measure the temperature click on the “Temperature” icon in the main menu screen.



NOTE!

Make sure you connect the Ambient Air Plug.

The options in the “Manifold Pressure” mode screen are:

- Option “Cancel”: click “Cancel” to exit the “Temperature” mode and return to the main menu.
- Option “Accept”: click “Accept” to save the temperature readings in the readings menu, see chapter 8.3

Fig. 29: Temperature screen

9.5 Tuning Guide

In the "Tuning Guide" menu all combustion test related readings are presented in a graph over the excess air. The tuning guide offers an advanced guidance to the technician to properly adjust the burner.

Tuning Guide



- In the main menu, click on the "Tuning guide" icon.

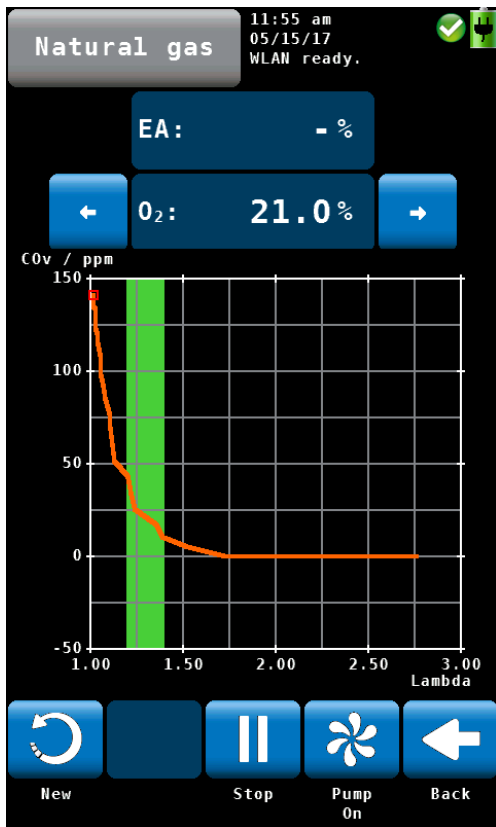

Fig. 30: Tuning Guide

The graph for adjusting the burner will be shown. The current reading is marked with a red box and any former reading is tracked with a green line.

The 'Green Zone' indicates the best combustion performance excess air range of the burner. The range is user changeable for any selected fuel (see chapter 7.3.3).

The figure on the left shows that the CO content in the flue gas increases significantly when the available excess air decreases.

- Click on "New" to delete the graph and start a new one.
- Click on "Back" to return to the main menu.

9.6 SETUP

In the setup-menu the user can adjust the screen or the measurement process. In order to see all parameters, scroll to the top or the bottom of the screen by sweeping the left column with a finger.

SETUP

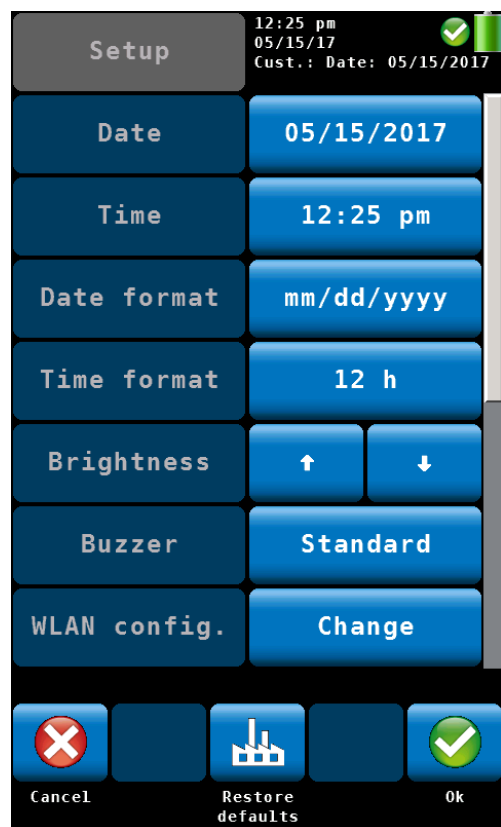

Fig. 31: Setup menu, the scroll bar shows that there are more parameters available.

- In the main menu, click on the setup icon.
- The analyzer will enter the setup menu. 7 of the 13 parameters are displayed.
- Sweep the left column with a finger to navigate through the setup menu.
- To change a parameter click on the correspondent key in the right column.
- Click on "OK" to save the new setting before leaving the setup menu.

The following options are available:

- 9.6.1 Option "Date" Change the current date of the analyzer's internal calendar with day, month and year.
- 9.6.2 Option "Time" Change the current time of the analyzer's internal clock (24 h mode) with hours and minutes.
- 9.6.3 Option "Date format" Select a date format. Possible options are dd.mm.yyyy / mm.dd.yyyy
- 9.6.4 Option "Time format" Select a time format. Possible options are 24 h / 12 h
- 9.6.5 Option "Brightness" Change the brightness of the display in 9 steps.
 - Click on the upwards arrow to set the back-light brighter, click on the downwards arrow to set the display darker.



NOTE!

A bright display will increase the power consumption.

- 9.6.6 Option "Buzzer" Change the sound of the buzzer. The options are Standard, Loud or Off,
- 9.6.7 WLAN configuration

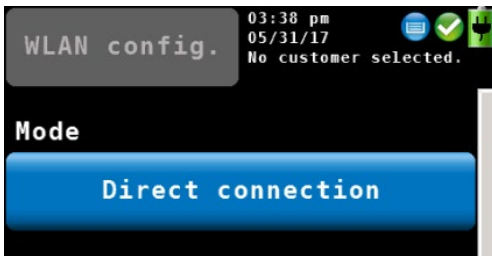

Fig. 32: WLAN configuration: Mode

- In the main menu select **Setup > WLAN-configuration**
- Select between 3 WLAN modes: **Off, Direct connection and Router connection.**

Mode „OFF“

It is not possible to use the Wohler A 450 App.

Mode „Direct connection“

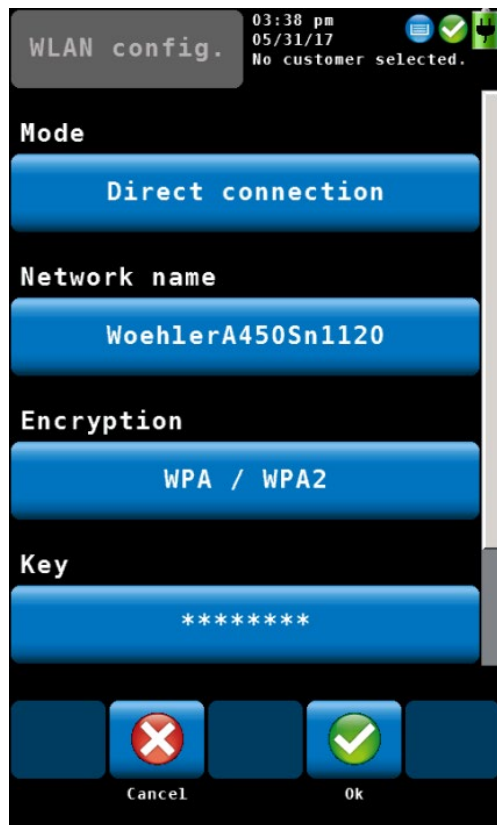

Fig. 33: WLAN configuration – Direct connection

If you do not have access to a router network, select **Direct Connection**.

In this case the analyzer will create its own wireless network. You can connect your mobile device (tablet or smartphone) to the analyzer's network.

Note!

After you have selected „Direct connection“ and confirmed with OK, in the upper display “WLAN ready” will appear (alternating with the selected customer).

Network name

The name of the network of the analyzer is as follows:

WoehlerA 450/serial number

Encryption

Select the channel where the Wohler A 450 sends. You can select a channel where there are few other devices.

NOTE!

Normally it is not necessary to change this setting.

Key

Network password that you have to enter in your mobile device. The password (factory setting) is **12345678**.

- Click on „Key“ to change the password.
- Enter a new password (min. 8 figures, max. 24 figures)

Mode „Router Connection“



Fig. 34: Router connection

Encryption

- Confirm with **OK**.



Note!

You have to confirm the settings with **OK**, before you can establish the WLAN connection to your mobile device.

- Select „Router connection“ if there is a permanent WLAN network in the house that you want to use.
- Click on **Network name**.

After a few seconds a list of all available networks will appear in the display.

- Click on the network that you want to use.
- If the network is protected with a password, enter the password (the password must have at least 8 characters)
Another possibility to enter the password is to click on “Key” in the WLAN-configuration-display.
- Confirm with **OK**.

The analyzer will connect to the router network now.

Encryption of your router. It is possible to disable the encryption by setting **Encryption > None**. In this case everybody can log on to the network. For this reason we recommend not to change the encryption settings.

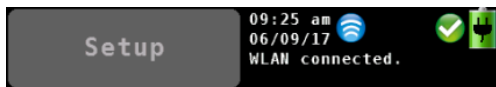

Fig. 35: „WLAN connected“ appears in the upper display, alternating with the selected customer



HINWEIS!

After the analyzer has been connected to the router network and you have confirmed your settings with OK, in the upper display the WLAN icon will appear and the text “WLAN connected”.

- Connect your mobile device to the same router network.
 - Open the Wohler A 450 App.
 - In the App, click on “Connect device”.
- The App will now connect to the Wohler A 450.

- 9.6.8 Option "Quick save"** If the quick save option is activated, the analyzer will automatically save the measurement records under a new customer. The customer name will be the measurement date and the measurement time. (see Chapter 8.4)
- Default: "Quick save" off
- 9.6.9 Option "Customer by"** Change the order of the saved records between customer name or number.
- 9.6.10 Option "Device by"** Change the order of the saved records between fireplace name or number.
- 9.6.11 NO_x calculation** Here the user can enter the NO₂ percentage on which the calculation of the NO_x value is based. The default NO₂ percentage is 5 %. Only change the NO₂ factor, if the boiler manufacturer recommends it.
- 9.6.12 Filter warning** If a filter warning appears in the display, you can delete it with this option.
- 9.6.13 Signals** The user can set up the reading segment according to his needs.
- Click on "change" to enter the signals menu.
 - In the left column (Display) click on the key that has to be substituted .
- The key will turn to green.
- In the right column (signals), click on the key that shall substitute the green key in the left column.
 - This key will now appear in the left column instead of the green key.
 - To change a unit, in the left column (display) click several times on the key whose unit has to be changed. You will find the possible units in the table of chapter 7.3.1.
- The icons in the footer have the following function:
- Cancel: Escape without saving the modifications.
 - Restore defaults: Reset to factory settings.
 - Remove signal: Remove a value from the



Fig. 36: Configuration of the readings segment.

readings segment.

- OK: Confirm the modification and return to the Setup menu.

9.6.14 Customer Logo

- Click on "Change", enter your logo and confirm with OK.

Your logo will now appear on all printouts.

9.7 Calibration

In the calibration menu a digitally assisted calibration of all sensors can be done. To open the calibration menu it is necessary to enter a password. For this reason unauthorized persons cannot calibrate the analyzer and incorrect settings are avoided.

The calibration of the analyzer is allowed to trained personnel ONLY. Please contact Wohler for more information.

10 Customer data

The analyzer allows to save the values in different fireplace folders. You can assign a system or several systems to a customer. Each customer and each system has its own number.

10.1 Set up a new customer



Fig. 37: Creating a new customer folder

- There are two possibilities:
 1. Go to the main menu and click on the Customers icon or
 2. Click on the customer icon during the search for the hotspot.
- Click on the New Customer Icon to create a New Customer folder.
- Enter the name and the number of the customer and the device/fireplace. Confirm with OK.

10.2 Save records



- In the Readings menu (see chapter 8) click on the Save-icon to save all marked measurement records under a customer and a fireplace. The analyzer will enter the customer menu.

The customer menu shows a list of all customers.

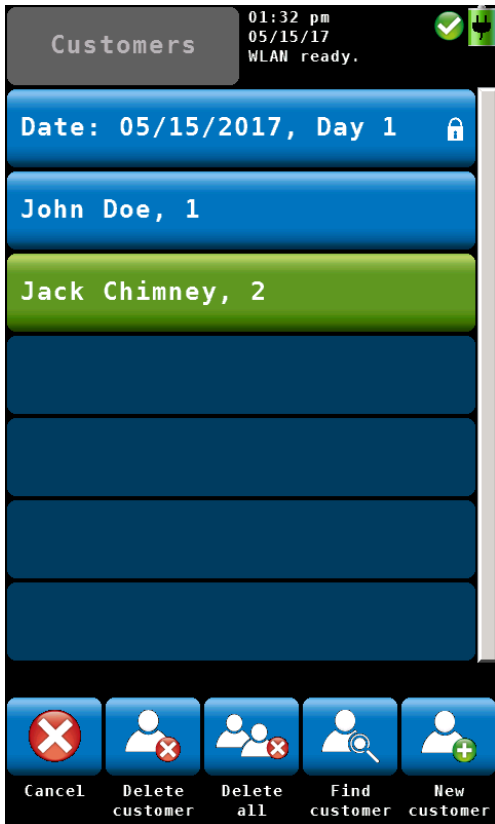

- Click on a customer. The analyzer will enter the system menu.
- Click on a system.
The analyzer will save the marked measurement records under this system.

Fig. 38: Selecting a customer in the customer menu.

10.3 Search function : customer, system, customer number, device number



- In the customer menu click on the “Find customer” icons.



Fig. 39: Customer research

- Enter any part of the customer name.
At the bottom of the display the first result will be shown. Click on the arrow key to see the other results and select the customer.



Research by name or by number

After selecting the customer, search the system in the same way.

- Click on the icon „Find system“.



Note!

In the setup menu you have the possibility to select if you want to search the customer/device by name or by number.

10.4 New customer



- Click on the **New customer** icon in the main menu to create a new customer folder.

10.5 Delete customer



In the customer menu it is possible to cancel a selected customer.

- Click on the "Delete customer" icon. The icon will become green.
- Select the customer to be canceled and confirm.

10.6 Delete all



- To delete all customers from the analyzer click on the "Delete all" icon.

11 Data exchange with the PC

With the Wohler A 450 Software it is possible to exchange the data with the PC via USB or WLAN.



NOTE!

The data transfer and the functions of the Software are explained in the Manual Wohler A 450 PC Software.

12 Troubleshooting

Problem	Possible reason	Solution
Empty battery icon	Battery is empty.	Recharge battery.
No reaction of the analyzer		Reset: Push the transport lock to the right and then to the left again (see Fig. 1)
The Flue gas temperature is not shown in the display	The temperature plug is not plugged in correctly.	Plug in the temperature plug.

13 Maintenance

Proper operation of the Wohler A 450 requires regular maintenance.

13.1 Maintenance work

Interval	Maintenance work
If filter warning appears in the display.	Change water-stop filter
Once a year	Return analyzer for check and calibration to a Wohler certified service station
If necessary	Grease the seal rings with silicone.

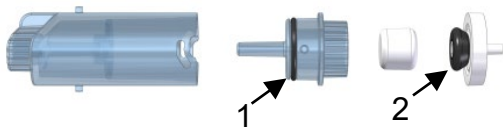

Fig. 40: Condensation trap: seal ring on the filter cover (1) and on the water-stop-filter (2)



Attention!

The seal ring of the water-stop-filter should not be greased.

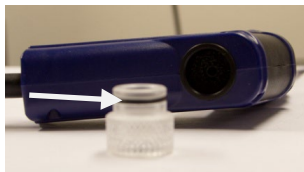

Fig. 41: Seal ring of the Plexiglas Plug of the probe handle

- If necessary grease the seal ring of the plexi-glas plug of the probe handle.

13.2 Removing condensate

The condensate will be collected in the condensate trap. To remove the condensate follow the steps below.

! Attention!

Before pulling the condensate trap out of the analyzer, switch off the analyzer or stop the flue gas pump.



Fig. 42: Pulling the condensate trap out of the analyzer

- Turn the condensate 90° to the left and pull it out of the analyzer.

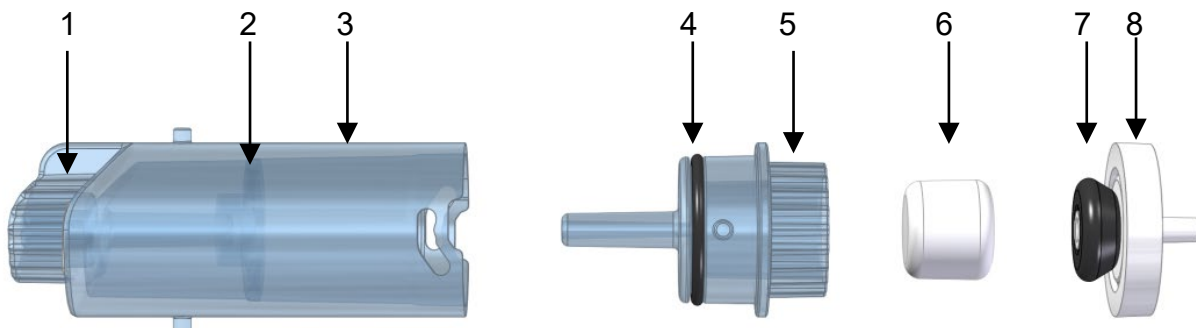

Fig. 43: Condensate trap

1. Probe connection of the condensate trap
2. Condensate panel (inside the condensate trap)
3. Condensate bin
4. Seal ring
5. Filter cover
6. Cotton filter
7. Seal ring of the water stop filter
8. Water stop filter

- Turn the filter cover a little, so that you can pull it from the condensate bin.



CAUTION!

The condensate panel always has to stay inside the condensate bin.

- Spill the condensate out of the cup.

13.3 Changing the filters

If the cotton filter or the water stop filter are clogged, a filter warning will appear at the top of the display.

- In this case check the filter and change it if necessary.

After the filter has been changed the warning will disappear. If this is not the case, you can delete the filter warning in the setup-menu, see chapter 9.6.12.

13.3.1 Cotton filter



Fig. 44: Filter cover and cotton filter

- Pull the cotton filter out of the filter cover.
- After every combustion test control the cotton filter and replace it if wet or dirty.

13.3.2 Water stop filter

The water stop filter blocks water from entering the analyzer. When the water stop filter closes, it will change color. In this case it has to be replaced.

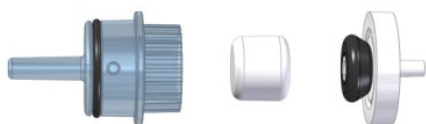

Fig. 45: Water stop filter (on the right) with seal ring

- Pull the water stop filter out of the filter cover and remove the seal ring.



Fig. 46: Filter holder with water stop filter.

- Attach the seal ring to the new water stop filter (on the side with the red lettering).
- Plug the water stop filter on the filter holder again.

13.4 Sensor diagnosis and replacement

Electrochemical gas sensors are subject to wear. The life of the measuring sensors will be determined by numerous outside parameters such as the care provided for the analyzer (removal of condensate), the frequency of use and regular maintenance.

This explains why the average life of measuring sensors will be determined by specific experience.

O₂-sensor 4 years

CO-sensor 4 years

The sensors can be changed in the factory or by an authorized service point. The user can also change the sensors himself.

The Wöhler A 450 has an advanced electronic self diagnosis program.

You can enter the diagnosis screen directly after having switched on the analyzer during self check and calibration .

Diagnosis



- Click on the Diagnosis icon.

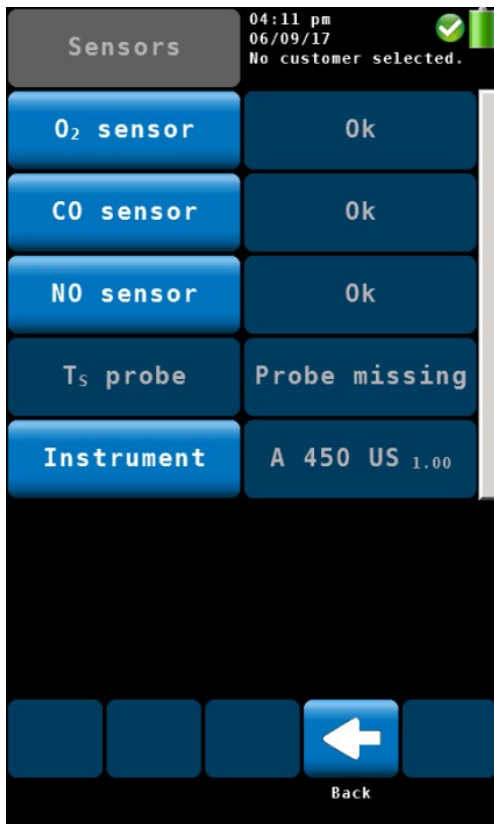

Fig. 47: Sensor diagnosis



Status: OK:



Status: Service



Zeroing sensor

- The diagnosis screen shows the sensor status (OK or NOT OK) and the firmware version.
- After a click on the sensor key, detailed information about the sensor status will appear in the display.
- After a click on the instrument key, detailed information about the analyzer will appear in the display: Version, serial, WLAN module, production date, calibration date, hours of operation, number of measurements, charge cycles.
- Click on OK to enter the search for the core flow again.

The sensor status is continuously displayed in the right top of the screen. The list below shows the possible diagnosis feedback:

- Status icon: Yellow sign icon indicates a problem. A note will appear in the display instate of date and time.
- "OK" or "Service" will appear for the O₂ or CO-sensors.
- Zeroing pressure sensor: During zeroing of the pressure sensor the blue icon appears on the screen. Do not expose any differential pressure to the analyzer now.



NOTE!

If the "service" message appears, first turn the analyzer off and on again. Start the diagnosis screen again. Only when the service message still appears on screen, the sensor has to be changed.

The order of the sensors is as follows (from the left to the right): O₂-sensor, CO sensor, NO-sensor.

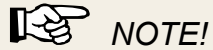

If the user himself replaces the sensors, the sensor date shown in the diagnosis menu will update automatically.

Replace the sensor as follows:



- Power off the analyzer.
- Loosen the 2 screws of the cover with a cross-headed screwdriver.
- Remove the cover from the analyzer.

Fig. 48: Bottom of the device - Open the cover by loosening the cross-head screws .

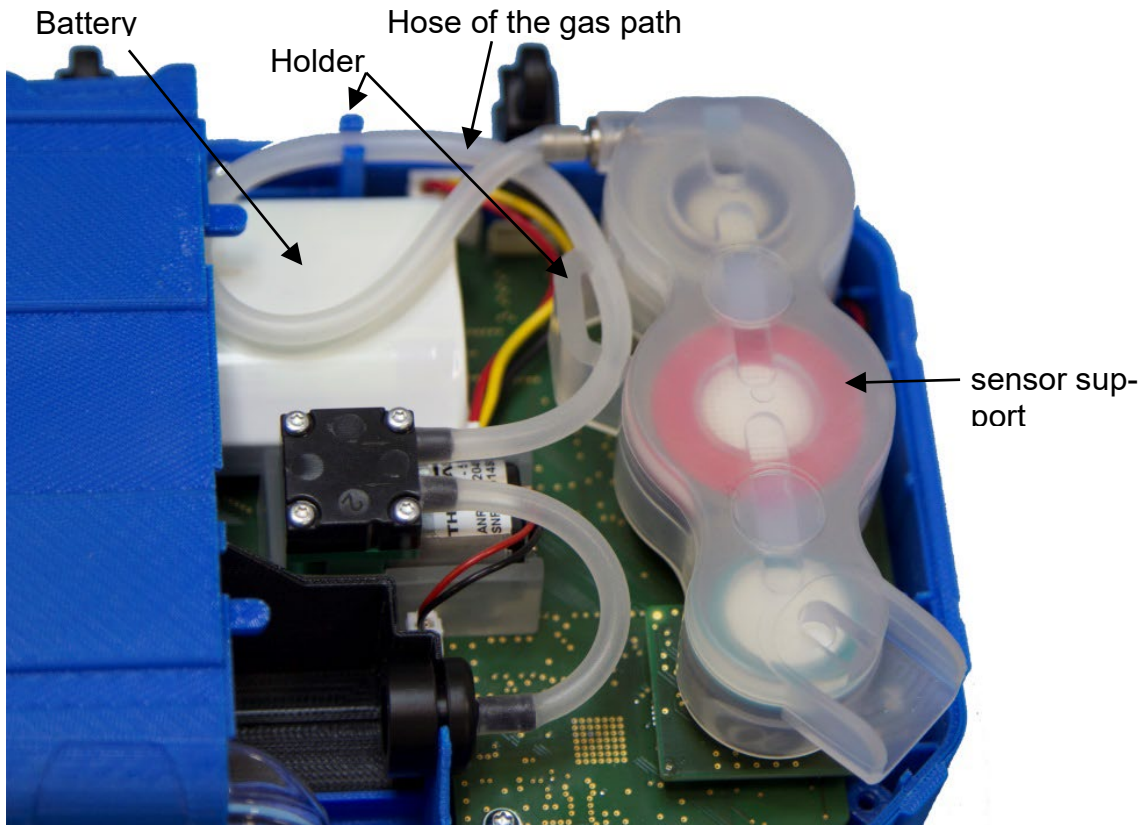
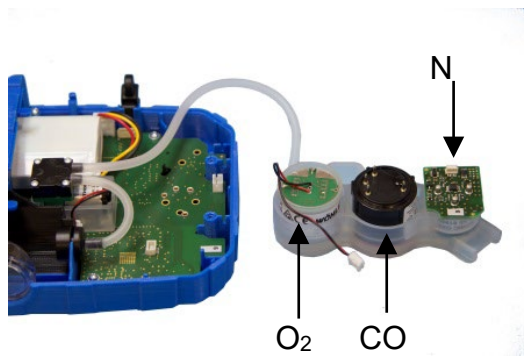

Fig. 49: Bottom of the analyzer with cover removed



- Cautiously remove the transparent hose of the gas path from the holders.
- Cautiously remove the sensor support from the analyzer.



NOTE!

The hose of the gas path can stay connected to the gas pump.

Fig. 50: Sensor support removed from the analyzer

Replacing the O₂ Sensor

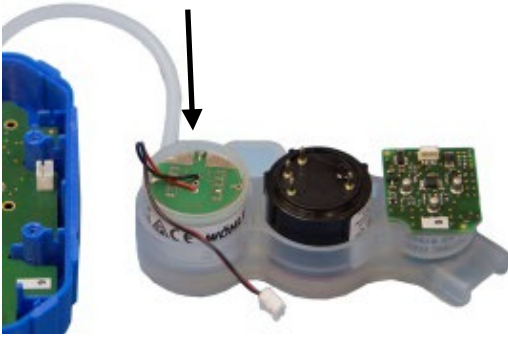

Fig. 51: Connector of the O₂-sensor removed

- Remove the 2-pin connector of the O₂ sensor.
- Replace the O₂ sensor by a new one.
- Plug the new connector to the original place.
- Plug the O₂ sensor to the board.

 **NOTE!**

The hose of the gas path can stay connected to the gas pump.

Changing the CO sensor

- Replace the sensor by a new one.
- Plug the CO sensor to the board.

 **NOTE!**

After installing a new CO-sensor you must enter the calibration values in the calibration menu, see chapter 7.2.

Installing a NO-sensor

- It is possible to install an NO-sensor
- Plug the NO-sensor to the board in place of the tamping.

 **CAUTION!**

After the NO sensor has been installed, an activation time of 24 hours must be observed. During the activation period the battery must be active, see chapter 6.4.

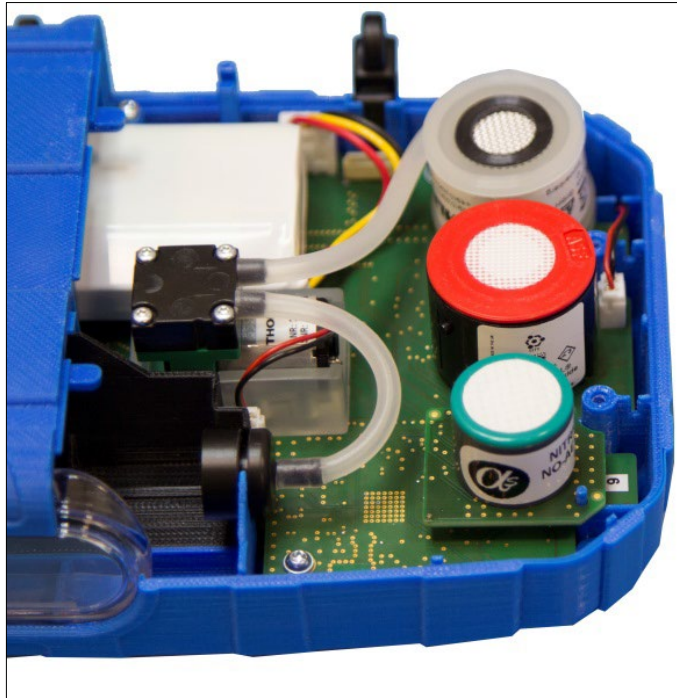

Fig. 52: Sensors plugged to the board. Top down: O₂, CO and NO (option)

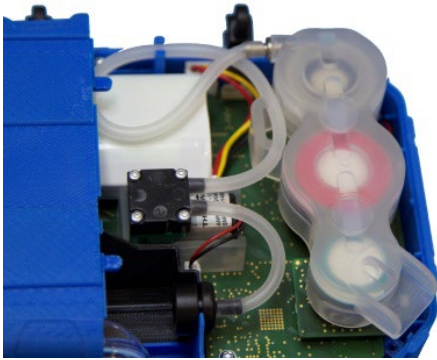

Fig. 53: Sensor support placed on the sensors and hose of the gas path correctly installed in the holders.

- Place the sensor support on the sensors again.
- Install the hose of the gas path correctly in the holders.



CAUTION!

Take care not to bend the hose.

- Replace the cover on the analyzer and fix it with the two screws.



- After a change of the CO-sensor, you must enter the calibration values in the calibration menu.
- Switch on the analyzer.
- In the main menu, click on the calibration icon.
- Enter the Code 4798
- Click on **Calibrate CO-sensor**.
- Enter the calibration value **Gain**. You will find the gain value printed on the CO-sensor.
- Press OK to confirm.

Fig. 54: Entering the calibration values in the calibration menu (only CO-sensor)

13.5 Replacing the battery



WARNING!

Incorrect use of the battery can cause injury!

Never dispose the battery to fire or high temperatures. Danger of explosion!

Liquids can leak out of the battery due to mistreatment. Never touch the liquid. If you get in contact to the liquid remove it with water. If the liquid comes into contact with eyes, rinse with water immediately for 10 minutes and consult a doctor immediately!

13.5.1 Replacing the battery

The Wöhler A 450 is equipped with a rechargeable lithium ion battery 3.6 V, 2250 mAh. Only after a long working period the battery has to be changed. In this case send the analyzer to your dealer or change the battery as follows:

- Switch off the analyzer. Open the analyzer as described before in the chapter "sensor replacement".
- Remove the sensor support from the analyzer, see Fig. 53.

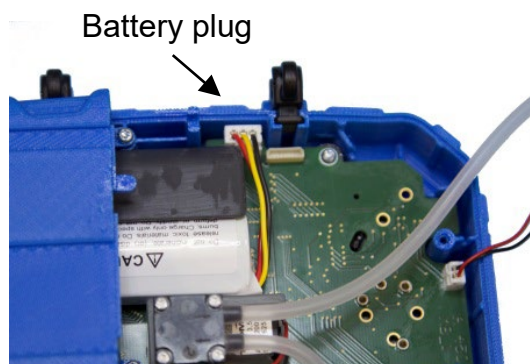

Fig. 55: Battery in the black adapter, sensors removed, O₂-Sensor, plug and hose of the gas path are still connected.



NOTE!

The hose of the gas path can stay connected to the gas pump. Also the plug of the O₂-sensor can stay connected.

- Pull out the battery plug and remove the battery.
- Put a new battery into the black adapter. Connect the battery plug.



NOTE!

As soon as the battery has been connected, the analyzer will switch on.

- Place the sensor support at its original position. Take care that the sensor contacts are correctly plugged in.
- Install the hose of the gas path correctly in the holders.

- Replace the cover and lock it.
- Secure the cover with the three screws.

14 Six-monthly check

The analyzer has to be checked every 6 month by a service point which is officially authorized. The prescription VDI 4208, page 2 specifies the minimum requirements.

The following tests have to be performed:

- with test gas: O₂-measurement, CO-measurement, cross-sensitivity of the CO-measurement towards NO, NO-measurement (Option)
- The flue gas temperature T_A has to be checked with a reference standard at two measuring points: one point in the lower part and one point in the upper part of the measuring range.
- The ambient air temperature T_L will be checked at one measuring point with a reference standard.
- The draft has to be checked with an adequate draft regulator.
- The flow of the flue gas to be analyzed will be controlled by a rotameter at the sucking side of the gas probe.
- The gas probe and the analyzer will be optically checked for pollution, condensation etc.

15 Guaranty and Service

Each Wohler A 450 will be tested in all functions and will leave our factory only after extensive quality control testing. The final control will be recorded in detail in a test report and delivered with any unit.

If used properly, the warranty period for the **Wohler A 450** will be 48 month from the date of sale.

If used properly, the warranty period for the **Wohler A 450 L** will be 24 month from the date of sale.

Consumables (e.g. thermocouple, batteries and special sensors) are not covered by this warranty.

If the analyzer is equipped with a NO-sensor, the warranty period of the NO-sensor will be 12 month.

This warranty does not cover the freight and packing costs when the filter is sent to the factory for repair.

Service by non authorized personnel or making modifications to the analyzer voids any warranty.

Excellent SERVICE is very important to us. Therefore, of course, we are readily available to assist you after the warranty period ends.

- When you send your meter to us, we will repair it within a few days and return it via our trusted parcel carrier.
- Immediate help is provided by our technical staff over the telephone.

16 Declaration of conformity

The manufacturer:

Wöhler Technik GmbH

Wöhler-Platz 1, D-33181 Bad Wünnenberg

declares that the product

Product name: Combustion Analyzer

Model number: Wöhler A 450 / Wöhler A 450 L

complies with the key safety requirements set down in the guidelines of the Council for the Harmonization of the Legal Requirements of the Member States 2014/53EG.

Approved by TÜV for 1. BImSchV and KÜO,

for fuel and gas heating appliances according to VDI 4206 page 1

The following standards were availed of to evaluate the product in respect of the electro-magnetic compatibility:

ETSI EN 301 489-1 V2.1.1 (2017-02)

ETSI EN 301 489-17 V3.1.1 (2017-02)

EN 50270:2015

ETSI EN 300 328 V2.2.2 (2019-07)

This device complies with Industry Canada licence-exempt RSS standard(s) and part 15 of the FCC Rules. Operation is subject to the following two conditions: (1) this device may not cause interference, and (2) this device must accept any interference, including interference that may cause undesired operation of the device.

Note: This equipment has been tested and found to comply with the limits for a Class A digital device, pursuant to part 15 of the FCC Rules. These limits are designed to provide reasonable protection against harmful interference when the equipment is operated in a commercial environment. This equipment generates, uses, and can radiate radio frequency energy and, if not installed and used in accordance with the instruction manual, may cause harmful interference to radio communications. Operation of this equipment in a residential area is likely to cause harmful interference in which case the user will be required to correct the interference at his own expense.

Changes or modifications not expressly approved by the party responsible for compliance could void the user's authority to operate the equipment.

Le présent appareil est conforme aux CNR d'Industrie Canada applicables aux appareils radio exempts de licence. L'exploitation est autorisée aux deux conditions suivantes : (1) l'appareil ne doit pas produire de brouillage, et (2) l'appareil doit accepter tout brouillage radioélectrique subi, même si le brouillage est susceptible d'en compromettre le fonctionnement.

17 Accessories

Probes

Multi Hole Probe	Art. n° 9615
Kit of capillary tubes	Art. n° 4521
Ambient Air Probe 280 mm	Art. n° 5511
Special Wall Temperature Probe	Art. n° 4651
Wöhler CHP-filter	Art. n° 5523

Pressure measurement

Measuring Set for nozzle pressure	Art. n° 56126
-----------------------------------	---------------

Plastic case

Case Midi	Art. n° 6594
Case Maxi	Art. n° 4704

Printer

Wöhler TD 100 fast thermal printer	Art. n° 4160
Paper for thermal printer	Art. n° 4145

Extras

Differential pressure adapter	Art. n° 23080
Wöhler Magnet Holder	Art. n° 6142
Wöhler Clamping Cone for probes 8 mm Ø	Art. n° 2494
Wöhler PTFE Cone for probes 8 mm Ø	Art. n° 2463
PC Software Wöhler A 450	Art. n° 6595

-

Spare parts and consumables

Water Stop Filters, 3 pcs.	Art. n° 9621
Cotton Filters, 150 pcs.	Art. n° 4288