



PT0E-1194

Portable Gas Detector  
**RX-8000**  
**Operating Manual**  
**(PT0-119)**

---

## <Contents>

1. Outline of the Product.....	2
1-1. Preface.....	2
1-2. Purpose of use.....	2
1-3. Definition of DANGER, WARNING, CAUTION, and NOTE.....	3
2. Important Notices on Safety.....	4
2-1. Danger cases.....	4
2-2. Warning cases.....	6
2-3. Names of internal product components.....	7
2-4. Safety information (Applicable for ATEX/IECEX).....	9
3. Product Components.....	10
3-1. Main unit and standard accessories.....	10
3-2. Names and functions for each part.....	12
4. How to Use.....	14
4-1. Before using the gas detector.....	14
4-2. Preparation for start-up.....	14
4-3. Basic operating procedures.....	18
4-4. How to start the gas detector.....	19
4-5. How to detect.....	21
4-6. Modes.....	23
4-7. Air calibration mode.....	24
4-8. Display/setting mode.....	26
4-9. Pump OFF mode.....	29
4-10. Manual memory mode.....	30
4-11. How to exit.....	31
5. Operations and Functions.....	32
5-1. Fault alarm pattern.....	32
5-2. Other functions.....	33
6. Maintenance.....	34
6-1. Maintenance intervals and items.....	34
6-2. Gas calibration.....	36
6-3. How to clean.....	40
6-4. Parts replacement.....	41
7. Storage and Disposal.....	43
7-1. Procedures to store the gas detector or leave it for a long time.....	43
7-2. Procedures to use the gas detector again.....	44
7-3. Disposal of products.....	44
8. Troubleshooting.....	45
9. Product Specifications.....	47
9-1. List of specifications.....	47
9-2. List of accessories.....	48
10. Definition of Terms.....	49

## 1

# Outline of the Product

## 1-1. Preface

Thank you for choosing our portable gas detector RX-8000. Please check that the model number of the product you purchased is included in the specifications on this manual.

This manual explains how to use the gas detector and its specifications. It contains information required for using the gas detector properly. Not only the first-time users but also the users who have already used the product must read and understand the operating manual to enhance the knowledge and experience before using the indicator/alarm unit.

## 1-2. Purpose of use

This product is a portable explosion-proof gas detector that measures the concentration of combustible gas and oxygen in crude oil vapors, etc. in inert gases or atmosphere.

Detection results are not intended to guarantee life or safety in any way.

There are 4 kinds of line up for this mode. Check the specifications before use and conduct gas detection properly in accordance with purposes.




In addition to this operating manual, an operating manual for the data logger management program (option) is available for the gas detector. Request RIKEN KEIKI if it is needed.

Product line up

Product	Detectable gas		
	Combustible (HC)	Combustible (CH4)	Oxygen (O2)
RX-8000 (HC/O2)	○	-	○
RX-8000 (CH4/O2)	-	○	○
RX-8000 (HC)	○	-	-
RX-8000 (CH4)	-	○	-

HC : Isobutane (i-C4H10) calibration

## 1-3. Definition of DANGER, WARNING, CAUTION, and NOTE

 DANGER	This message indicates that improper handling may cause serious damage on life, health or assets.
 WARNING	This message indicates that improper handling may cause serious damage on health or assets.
 CAUTION	This message indicates that improper handling may cause minor damage on health or assets.
NOTE	This message indicates advice on handling.

## 2

# Important Notices on Safety

## 2-1. Danger cases



### DANGER

<About explosion-proof>

- Do not modify or change the circuit or structure, etc.

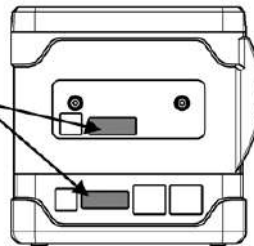
#### 【RX-8000】

- When measuring the oxygen concentration, do not measure anything but a mixture of air and combustible gases or vapors and toxic gases.
- When using this gas detector in a hazardous area, take the following countermeasures for preventing dangers resulting from electrostatic charges.
  - Wear anti-static clothes and conductive shoes (anti-static work shoes).
  - For indoor use, use the gas detector while standing on a conductive work floor (with a leakage resistance of 10 MΩ or less).
- IP protection class: IP20
  - \* IP20 is a protection class on explosion-proof certification. The IP protection class is compliant to IP67 level by factory default.
- Make sure that the product model on the nameplate is correct. Inappropriate combinations of models deviate from the range of explosion-proof certification. The nameplate shows the followings as well as the product model.
 

Product model	: Main unit: RX-8000 (TC20782)
	Dry battery unit: BUD-8000(R)(TC20783)
	Lithium ion battery unit: BUL-8000(R)(TC20784), BUL-8000(R1)(TC21112)
Manufacturer	: RIKEN KEIKI Co., Ltd.
Explosion proof class	: 【RX-8000】Ex ia IIC T4
	【BUL-8000(R), BUL-8000(R1), BUD-8000(R)】 Ex ia IIC T4
Ambient temperature	: -20 to 50°C
Charging terminal rating	: 【BUL-8000(R), BUL-8000(R1)】 Allowable voltage AC250V 50/60Hz
Warnings	: 【BUL-8000(R), BUL-8000(R1), BUD-8000(R)】 Inhibit to take off battery unit in non-hazardous area.

Nameplate location

Nameplate





## DANGER

### < About explosion-proof of the main unit >

- The battery units that can be connected are the BUL-8000(R)(TC20784), BUL-8000(R1)(TC21112) or BUD-8000(R)(TC20783).
- The specifications of the gas detector are as follows:
 

Pump circuit	: Allowable voltage of 4.95 V, allowable current of 1.12 A, and allowable power of 1138 mW
Infrared detection circuit	: Allowable voltage of 4.95 V, allowable current of 0.834 A, and allowable power of 853 mW
Buzzer circuit	: Allowable voltage of 4.95 V, allowable current of 0.431 A, and allowable power of 441 mW
Main circuit	: Allowable voltage of 4.95 V, allowable current of 0.717 A, and allowable power of 733 mW
Backup circuit	: 3.0 VDC, 10 $\mu$ A
Ambient temperature	: -20degree C to +50degree C

### < About explosion-proof of the battery unit >

- The main unit that can be connected is RX-8000(TC20782) only.  
The use with unspecified main units deviates from the range of explosion-proof certification.
- The specifications of the BUL-8000(R), BUL-8000(R1) are as follows:
 

Pump circuit	: Maximum voltage of 4.25 V, maximum current of 1.12 A, and maximum power of 901 mW
Infrared detection circuit	: Maximum voltage of 4.25 V, maximum current of 0.768 A, and maximum power of 618 mW
Buzzer circuit	: Maximum voltage of 4.25 V, maximum current of 0.410 A, and maximum power of 330 mW
Main circuit	: Maximum voltage of 4.25 V, maximum current of 0.653 A, and maximum power of 526 mW
Battery charging contact	: Allowable current of 250 VAC
Ambient temperature	: -20degree C to +50degree C

\*Chargin has to be done with the dedicated AC adaptor in non-hazardous area.  
And, the temperature should be beteen 0degree C and +40degree C.

- The specifications of the BUD-8000(R) are as follows:
 

Pump circuit	: Maximum voltage of 4.95 V, maximum current of 1.12 A, and maximum power of 1138 mW
Infrared detection circuit	: Maximum voltage of 4.95 V, maximum current of 0.834 A, and maximum power of 853 mW
Buzzer circuit	: Maximum voltage of 4.95 V, maximum current of 0.431 A, and maximum power of 441 mW
Main circuit	: Maximum voltage of 4.95 V, maximum current of 0.717 A, and maximum power of 733 mW
Power supply	: 4.5 VDC, 150 mA (LR6 3 pcs)
Ambient temperature	: -20degree C to +50degree C
- Do not attach and remove the battery unit or batteries in the dry battery unit in a hazardous location.
- Use specified AA alkaline batteries (LR6 TOSHIBA) for the dry battery unit.

### < About use >

- While conducting measurement in a manhole or confined space, do not lean over or look into the manhole or closed space. It may lead to dangers because oxygen-deficient air or other gases may blow out.
- Oxygen-deficient air or other gases may blow out from the gas exhausting outlet. Never inhale the air or gases.
- High-concentration (more than LEL) gases may blow out. Never use fire near the gas detector.

## 2-2. Warning cases



### WARNING

#### < Sampling point pressure >

- The gas detector is designed to draw gases around it under the atmospheric pressure. If excessive pressure is applied to the gas inlet and outlet (GAS IN, GAS OUT) of the gas detector, detected gases may leak out from its inside and may cause dangerous conditions. Be sure that excessive pressure is not applied to the detector while used.
- Do not connect the gas sampling hose directly to a location with a pressure higher than the atmospheric pressure. The internal piping system may be damaged.

#### < Handling of sensor >

Do not disassemble the galvanic cell type sensor because it contains electrolyte. Electrolyte may cause severe skin burns if it contacts skin, while it may cause blindness if its contacts eyes. If electrolyte is adhered on your clothes, that part on your clothes is discolored or its material is decomposed. If contact occurs, rinse the area immediately with a large quantity of water.

#### < Fresh air adjustment in atmosphere >

When the air calibration is performed in the atmosphere, check the atmosphere for freshness before beginning the air calibration. If other gases exist, the adjustment cannot be performed properly, thus leading to dangers when the gas leaks.

#### < Battery level check >

- Before use, check that there remains sufficient battery power. When the gas detector is used for the first time or is not used for a long period, the batteries may be exhausted. Either fully charge the batteries or replace them with new ones before use.
- If a low battery voltage alarm is triggered, gas detection cannot be conducted. If the alarm is triggered during use, turn off the power and promptly charge the batteries in a non-hazardous area.

#### < Others >

- Do not throw the gas detector into fire.
- Do not wash the gas detector in a washing machine or ultrasonic cleaner.
- Do not block the buzzer sound hole. No alarm sound can be heard.
- Do not remove the battery unit while the power is ON.
- Do not drop or give shock to the gas detector by, for example, relocating the gas detector with a water trap, an optional accessory, attached. The gas inlet may be damaged.

## 2-3. Names of internal product components



### CAUTION

< Do not use the gas detector where it is exposed to oil, chemicals, etc. Do not submerge the gas detector under water on purpose. >

- Do not use in a place where the gas detector is exposed to liquids such as oil and chemicals.
- The gas detector, being compliant to IP67, is not water-pressure-resistant. Do not use the gas detector where a high water pressure is applied to it (under a faucet, shower, etc.) or submerge it under water for a long time. The gas detector is water-proof only in fresh water and running water, and not in hot water, salt water, detergent, chemicals, human sweat, etc.
- The gas inlet and outlet are not water-proof. Be careful not to let water such as rainwater get into these parts. Because this may cause trouble and gas cannot be detected.
- Do not place the gas detector where water or dirt gets accumulated. The gas detector placed at such a location may malfunction due to water or dirt that gets into the buzzer opening, gas inlet, etc.
- Note that drawing in dirty water, dust, metallic powder, etc. will significantly deteriorate the sensor sensitivities. Be careful when the gas detector is used in an environment where these elements exist.

< Do not use the gas detector in a place where the temperature drops below -20°C or rises over 50°C. >

- The operating temperature of the gas detector is -20 to 50°C. Do not use the gas detector at higher temperatures, humidities, and pressures or at lower temperatures than the operating range.
- Avoid long-term use of the gas detector in a place where it is exposed to direct sunlight.
- Do not store the gas detector in a sun-heated car.

< Observe the operating restrictions to prevent condensation inside the gas detector or gas sampling hose. >

Condensation formed inside the gas detector or gas sampling hose causes clogging or gas adsorption, which may disturb accurate gas detection. Thus, condensation must be avoided. In addition to the operating environment, carefully monitor the temperature/humidity of the sampling point to prevent condensation inside the gas detector or gas sampling hose. Please observe the operating restrictions.

< Do not use a transceiver near the gas detector. >

- Radio wave from a transceiver near the gas detector may disturb readings. If a transceiver is used, it must be used in a place where it disturbs nothing.
- Do not use the gas detector near a device that emits strong electromagnetic waves (high-frequency or high-voltage devices).

< Verify that the pump driving indicator is rotating before using the gas detector. >

If the pump driving indicator is not rotating, gas detection cannot be performed properly. Check whether the flow rate is lost.

< Never fail to perform a regular maintenance. >

Since this is a safety unit, a regular maintenance must be performed to ensure safety. Continuing to use the detector without performing a maintenance will compromise the sensitivity of the sensor, thus resulting in inaccurate gas detection.



## CAUTION

< Others >

- Pressing switches unnecessarily may change the settings, preventing alarms from activating correctly. Operate the gas detector using only the procedures described in this operating manual.
- Do not drop or give shock to the gas detector. The water-proof and explosion-proof properties and accuracy may be deteriorated.
- Do not use the gas detector while recharging it.
- When you measure concentrations of oxygen in inert gases for a long time, the carbon dioxide concentration in the air must be 15% or less. When you use the gas detector in the inert gas with a carbon dioxide concentration of 15% or higher, perform measurement in as short time as possible. Using the gas detector under high concentrations for a long time may shorten the life of the oxygen sensor.

## 2-4. Safety information (Applicable for ATEX/IECEx)

Observe the followings to maintain an explosion-proof system.

### <Overseas Specifications>

#### Outline of the product

- This product is a portable explosion-proof gas detector that measures the concentration of combustible gas and oxygen in crude oil vapors, etc. in inert gases or atmosphere.
- Gases are drawn by the built-in pump.
- As a power supply, either Li-ion battery unit (BUL-8000(R), BUL-8000(R1)) or dry battery unit (BUD-8000(R)) can be used.
- The battery unit can be replaced by users.

#### Technical data

Explosion-proof specifications	Explosion-proof class	ExialICT4Ga II1GExialICT4Ga
	Ambient temperature	-20 to 50°C
Electrical specifications	Ambient temperature (for charging)	0 to 40°C
	Power supply	<ul style="list-style-type: none"> <li>• About lithium ion battery unit (BUL-8000(R), BUL-8000(R1)) Two Lithium ion cells of BP-8000 (Maxell INR18650PB1. Um=250V) are connected in parallel to the Lithium ion battery unit.</li> <li>• About dry battery unit (BUD-8000(R)) TOSHIBA AA alkaline batteries (LR6) can be used.</li> <li>• Maxell CR1220 battery is used for backup.</li> </ul>

Certificate numbers  
Applied standards

IECEX  
ATEX

IECEXDEK13.0091  
DEKRA13ATEX0228  
IEC60079-0:2011  
IEC60079-11:2011  
IEC60079-26:2006  
EN60079-0:2012  
EN60079-11:2012  
EN60079-26:2007

Precautions

- Do not charge the Lithium ion battery unit in a hazardous location.
- Charge the Lithium ion battery unit using the dedicated charger.
- Do not replace the battery unit in a hazardous location.
- Do not replace batteries in the dry battery unit in a hazardous location.
- Do not modify or change the circuit or structure, etc.
- Use either Lithium ion battery unit (BUL-8000(R), BUL-8000(R1)) or dry battery unit (BUD-8000(R)).  
Dry batteries used for the dry battery unit (BUD-8000(R)) are TOSHIBA AA alkaline batteries (LR6).

How to read instruction number

INST.No. 0 0 000 0000 00  
                  A B C D E

A: Manufacturing year (0-9)  
B: Manufacturing month (1-9, XYZ for Oct.-Dec.)  
C: Manufacturing lot  
D: Serial number  
E: Manufacturing code

Manufacturer


RIKEN KEIKI CO., LTD.  
2-7-6 Azusawa, Itabashi-ku, Tokyo, 174-8744 Japan  
Web site: <http://www.rikenkeiki.co.jp/>

## 3

# Product Components

## 3-1. Main unit and standard accessories

After opening the package, check the main unit and accessories.  
If anything in the following list is not included, contact RIKEN KEIKI.

<Main Unit>		<Standard Accessories>
RX-8000 main unit		<ul style="list-style-type: none"> <li>• AC powered charger : 1</li> <li>• Gas sampling probe and gas sampling hose : 1</li> <li>• Filter tube(CF-8385) : 1</li> <li>• Relay tube : 1</li> <li>• Shoulder strap : 1</li> <li>• Filter tube fixing belt : 1</li> <li>• Operating manual</li> <li>• Product warranty</li> </ul>
Li-ion battery unit		



### DANGER

#### < About explosion-proof >

- Do not modify or change the circuit or structure, etc.
- When measuring the oxygen concentration, do not measure anything but a mixture of air and combustible gases or vapors and toxic gases.
- When using this gas detector in a hazardous area, take the following countermeasures for preventing dangers resulting from electrostatic charges.
  - (1) Wear anti-static clothes and conductive shoes (anti-static work shoes).
  - (2) For indoor use, use the gas detector while standing on a conductive work floor (with a leakage resistance of 10 MΩ or less).
- IP protection class: IP20
  - \* IP20 is a protection class on explosion-proof certification. The IP protection class is compliant to IP67 level by factory default.

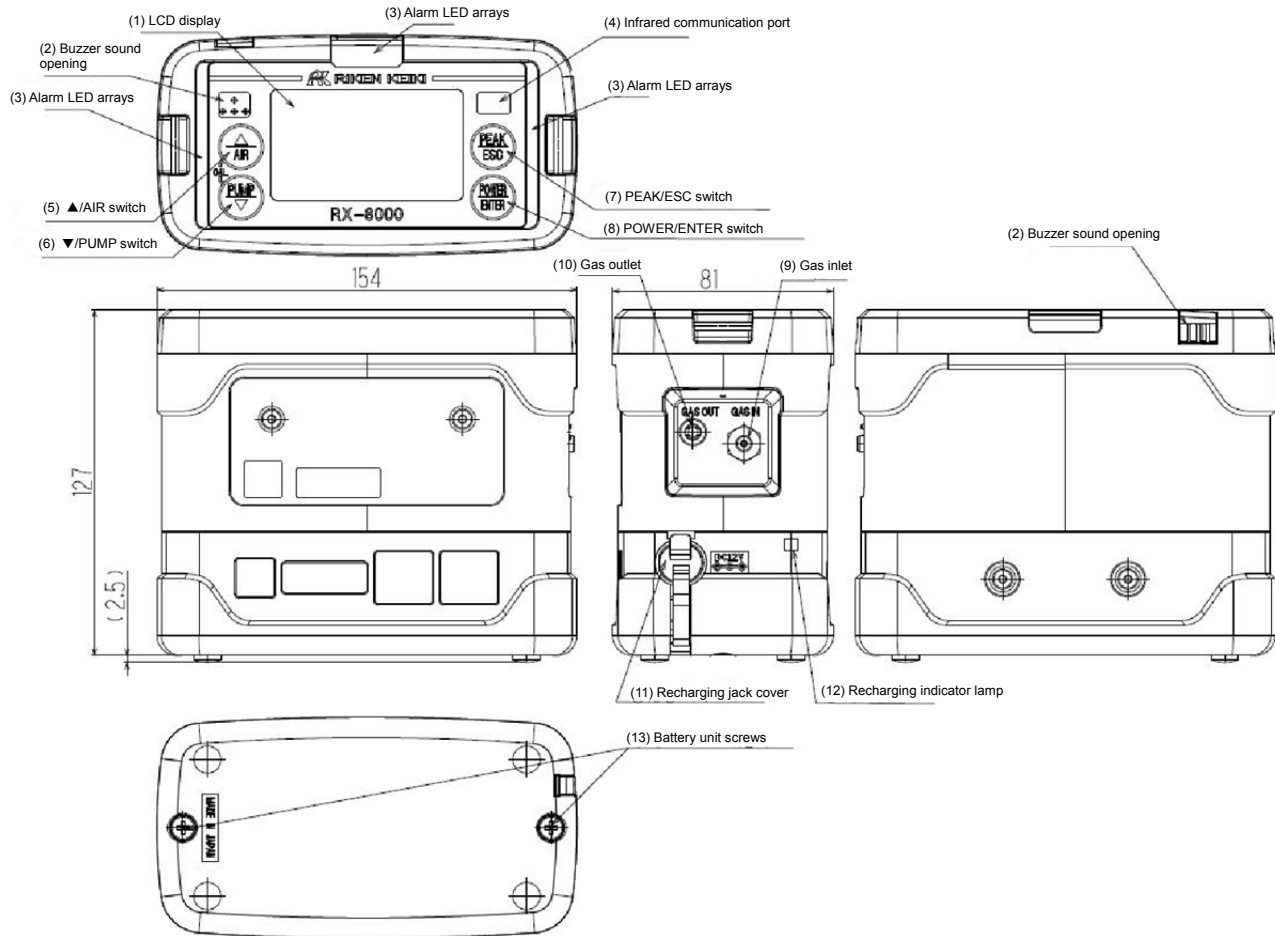
#### < About explosion-proof of the main unit >

- The battery units that can be connected are the BUL-8000(R)(TC20784), BUL-8000(R1)(TC21112) or BUD-8000(R) (TC20783).  
The use with unspecified battery units deviates from the range of explosion-proof certification.



## 3-2. Names and functions for each part

### <Main Unit>



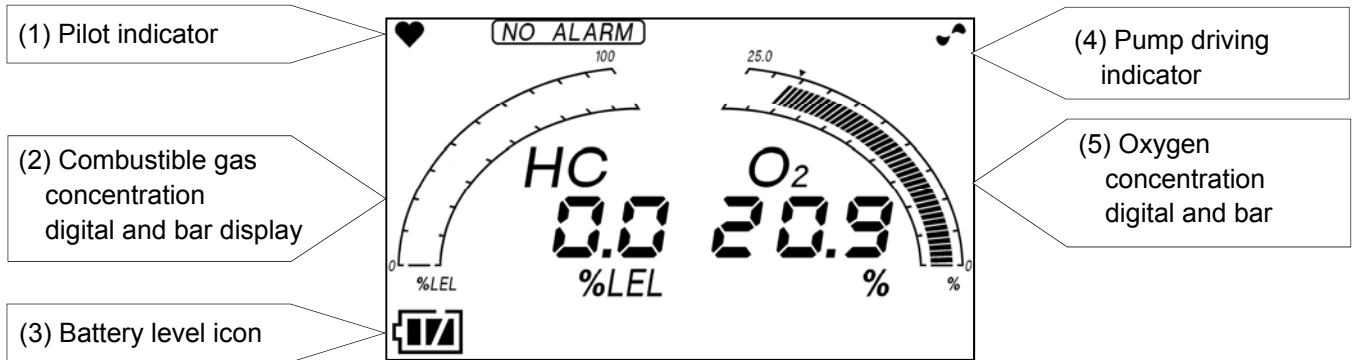
	Name	Function
(1)	LCD display	Displays gas concentrations, alarms, etc.
(2)	Buzzer sound opening	Emits a buzzer sound at an alarm. (Do not block it.)
(3)	Alarm LED arrays	The lamp blinks in response to an alarm.
(4)	Infrared communication port	Used to carry out data communications with a PC in data logger mode.
(5)	▲/AIR switch	Keep this switch pressed to perform fresh air calibration. It is used to increase numerical values.
(6)	▼/PUMP switch	Turns on and off the pump. It is used to decrease numerical values.
(7)	PEAK/ESC switch	Press this switch to change between display modes.
(8)	POWER/ENTER switch	Turns on and off the power.
(9)	Gas inlet	Connect a sampling hose to this port.
(10)	Gas outlet	Exhausts the gas drawn into the gas detector. (Do not block it.)
(11)	Recharging jack cover	Remove this cover to connect an AC powered charger and recharge the batteries.
(12)	Recharging indicator lamp	Lights up in red during recharging and goes off when recharging is completed.
(13)	Battery unit screws	Turn these screws to detach and replace the battery unit.



**CAUTION**

- Do not jab the buzzer opening with a sharp-pointed item. The unit may malfunction or get damaged, allowing water or foreign matter, etc. to get inside.
- Do not remove the panel sheet on the display. The water-proof and dust-proof performances will be deteriorated.
- Do not affix a label on the infrared port. Infrared communications can no longer be conducted.

< LCD Display >



	Name	Function
(1)	Pilot indicator	Displays the operating status in the detection mode. Normal: Blinking
(2)	Combustible gas concentration digital and bar display	Displays the gas concentration as a numeric value and a level in the bar graph.
(3)	Battery level icon	Displays the battery level. See the information below for the meanings of battery level icons.
(4)	Pump driving indicator	Displays the drawing status in the detection mode. Normal: Rotating
(5)	Oxygen concentration digital and bar display	Displays the gas concentration as a numeric value and a level in the bar graph.

**NOTE**

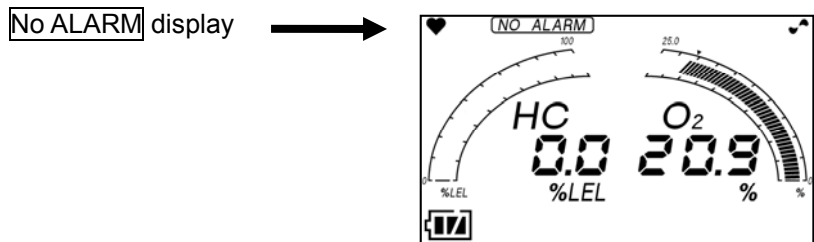
The meanings of battery level icons are as follows:

Sufficient / :Low / :Needs charging

If the battery level is lower than the above, the inside of the battery icon starts to blink ( ).

**NOTE**

- The gas alarm function is an optional setting.
- When NO ALARM lights up, no gas alarm pattern is performed.



## 4

# How to Use

## 4-1. Before using the gas detector

Not only the first-time users but also the users who have already used the product must follow the operating precautions.

Ignoring the precautions may damage the gas detector, resulting in inaccurate gas detection.

## 4-2. Preparation for start-up

Before starting gas detection, read and understand the following precautions. Ignoring these precautions may prevent correct gas detection.

Check that the main unit, relay tube, filter tube, gas sampling hose, and gas sampling probe are connected properly in this order.

- Check that the battery level is sufficient.
- Check that the filter and filter tube in the gas sampling probe are free of dust or clogging.
- Check that there is no bend or hole in the gas sampling hose and relay tube.

### < Recharging of Batteries >

(when the Li-ion battery unit BUL-8000(R), BUL-8000(R1) are used)

When the gas detector is used for the first time, or when the battery level is low, be sure to use the accessory AC powered charger to charge the batteries.



### CAUTION

- Use the dedicated AC powered charger.
- Charge the battery unit in a non-hazardous area.
- Charge the battery unit at ambient temperatures between 0 to 40°C.
- Do not use the gas detector while charging it. Correct measurements cannot be obtained. Furthermore, the batteries get deteriorated more quickly and may have shorter life.
- The charger is neither water-proof nor dust-proof. Do not recharge the batteries while the gas detector is wet.
- The AC powered charger is not explosion-proof.

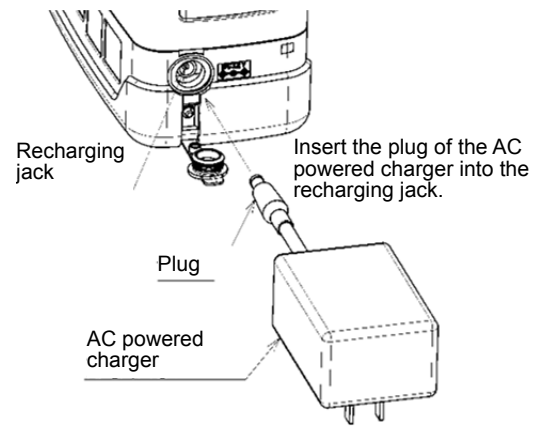
- (1) Open the charging jack cover of the gas detector.



### CAUTION

Do not pull the charging jack cover too hard. It may get damaged.

- (2) Put the plug of the AC powered charger into the recharging jack of the gas detector.
- (3) Connect the AC powered charger to the wall electric outlet. When charging is started, the charging indicator lamp lights up (red).  
(Charging time: Three hours at the maximum until the batteries are fully charged)
- (4) When charging is completed, the charging indicator lamp goes off.
- (5) When charging is completed, disconnect the AC powered charger from the wall electric outlet.
- (6) Pull out the AC powered charger plug from the power jack of the gas detector and reattach the recharging jack cover. Put the charging jack cover as far as it will go.



### CAUTION

- Do not use the gas detector with the recharging jack cover detached. Dust or water may get into the gas detector, causing it to malfunction. Replace the charging jack cover if it is damaged.
- If the charging jack cover is not completely closed, water may get in from the power jack. The same thing occurs if a minute foreign substance is caught beneath the knob.
- Disconnect the AC powered charger from the wall electric outlet while it is not in use.

### NOTE

- During recharging, the battery pack may get hot, but this is not an abnormality.
- The temperature of the gas detector is high immediately after charging is completed. Allow at least 10 minutes or more for the unit to cool down before using it. Otherwise, correct measurements may not be obtained.
- When fully recharged batteries are recharged again, the recharging indicator lamp does not go on.

### <Attaching Batteries>

(when the dry battery unit BUD-8000(R) is used)

When the gas detector is used for the first time, or when the battery level is low, attach new AA alkaline batteries.



### CAUTION

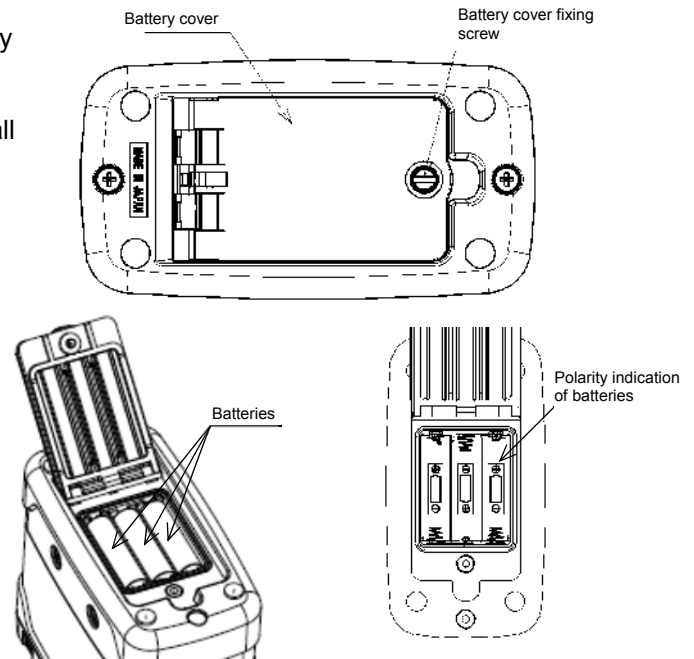
<Replacement>

- Turn off the power of the gas detector before replacing the batteries.
- Replace the batteries in a non-hazardous area.
- Replace all of the three batteries with new ones at one time.
- Pay attention to the polarities of the batteries.
- If the battery cover fixing screw is not completely tightened, the dry batteries may drop off or water may get in through the clearance.
- Water may also get in if a minute foreign substance is caught beneath the battery unit.

<Batteries>

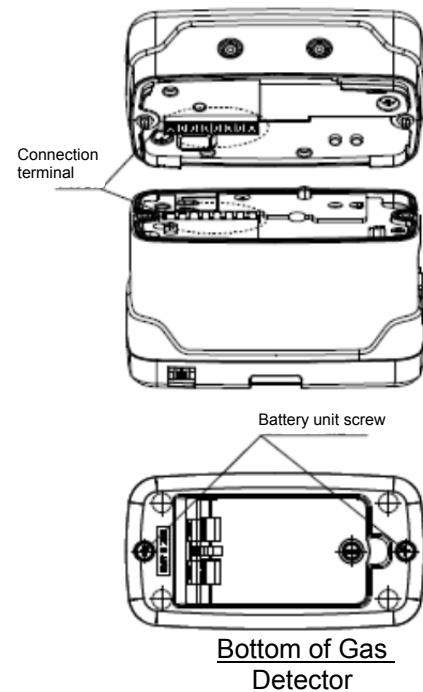
- Use AA alkaline batteries.
- Chargeable batteries cannot be used.

- (1) Using a flathead screwdriver or coin, turn the battery cover fixing screw counterclockwise to open the battery cover.
- (2) Paying attention to the polarities of batteries, replace all the three batteries with new ones.
- (3) Close the battery cover and tighten the battery cover fixing screw.



### <Releasing and Attaching the Battery Unit>

- (1) Loosen the two battery unit screws.  
(They need not be completely detached.)
- (2) Detach the battery unit.
- (3) Attach a new battery unit.



### NOTE

Make sure that the battery unit is installed in correct orientation by checking the locations of the connection terminal and projection portions.

- (4) Securely tighten the two battery unit screws.



### CAUTION

- Turn off the power of the gas detector before replacing the battery unit.
- Attach and remove the battery unit in a non-hazardous area.
- If the battery unit screw is not completely tightened, the battery unit may drop off or water may get in through the clearance. Water may also get in if a minute foreign substance is caught beneath the battery unit.
- Do not damage the rubber seal.
- To maintain the water-proof and dust-proof performances, it is recommended to replace the rubber seal every two years, whether or not it has an abnormality.

## <Connection of Gas Sampling Probe and Gas Sampling Hoses>

Attach the gas sampling hose to the gas sampling probe.



- Connect the relay tube, filter tube, gas sampling hose, and gas sampling probe in this order securely to the gas inlet (GAS IN) of the main unit.



### NOTE

Connect each part, such as to the gas inlet (GAS IN), until it clicks into place to ensure connection.

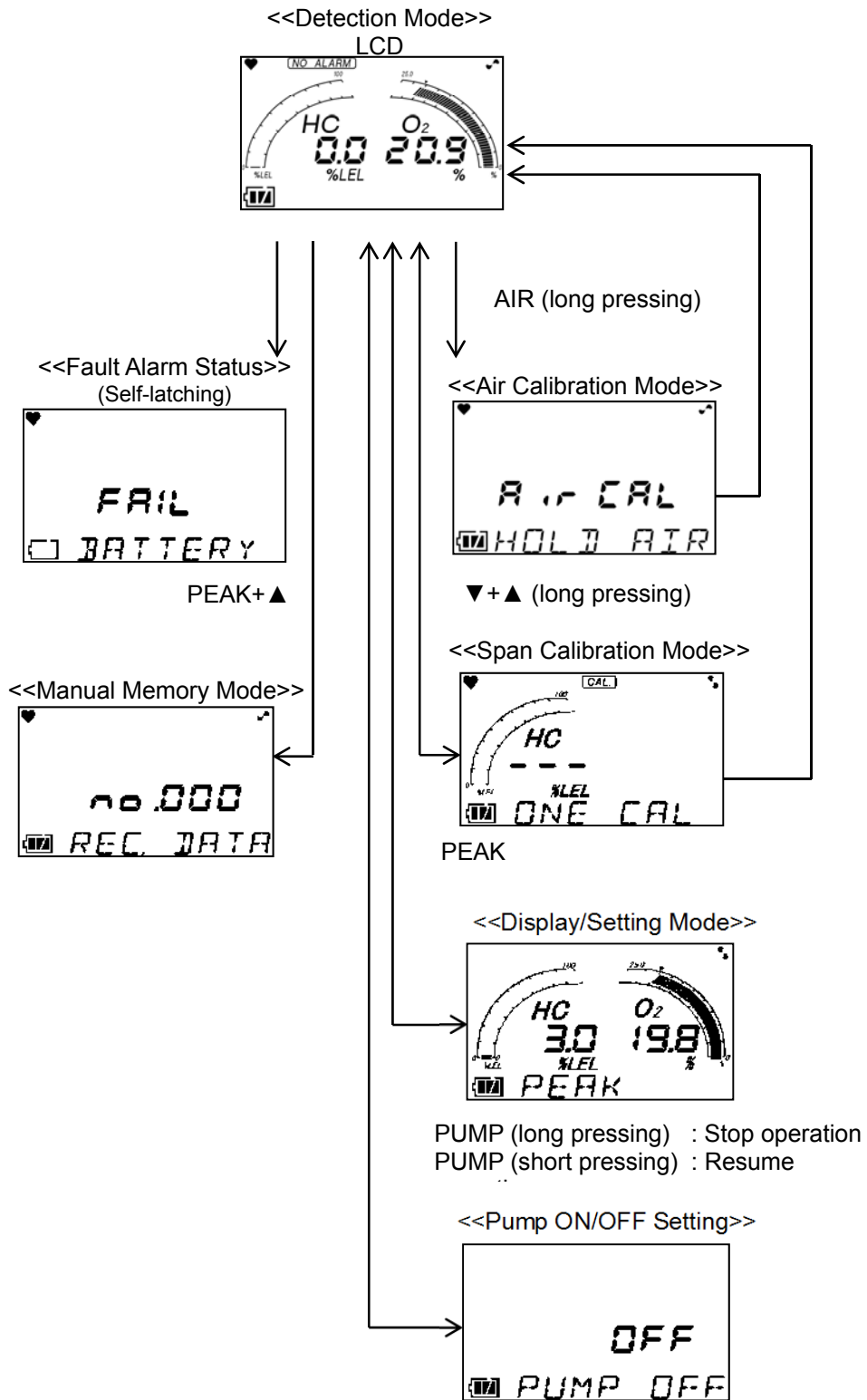


### CAUTION

- Use only a gas sampling hose specified by RIKEN KEIKI.
- Use the gas detector with the gas sampling probe connected so that no foreign substance is drawn into it.
- Connect a gas sampling probe and a gas sampling hose by fastening them manually without using any tool. If they are fastened too tightly using a tool, the plastic part of the gas sampling probe may be broken.

## 4-3. Basic operating procedures

Normally, the detection mode is used for normal operations. (The detection mode is activated after the power is turned on.)



## 4-4. How to start the gas detector

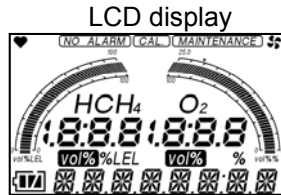
Keep the POWER switch pressed for three seconds or more to turn on the power. After the display automatically switches between Date/Time, Battery Voltage, and others and self diagnosis is conducted, the gas detector enters the detection mode.

<<Start-up Procedure>>

Keeping the POWER switch pressed for three seconds or more

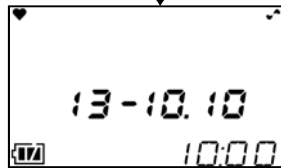


All LCDs Light Up.

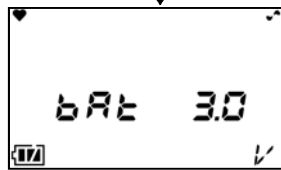


\* Keep it pressed until the alarm lamp lights up and the buzzer sounds once (Beep).

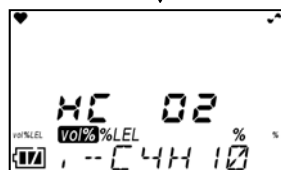
Date/Time Display



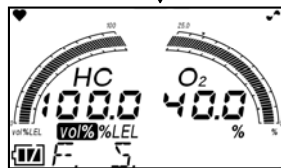
Battery Voltage Display



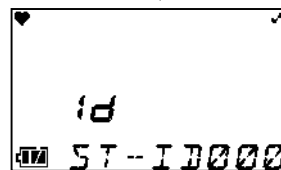
Gas Name Display



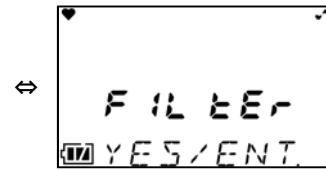
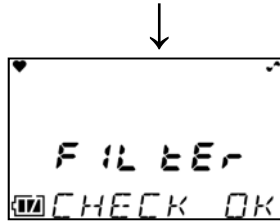
Full Scale Display



ID Display

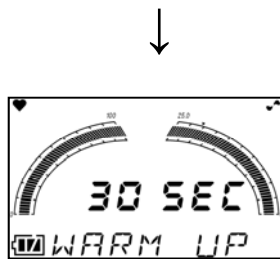


**Checking connection of filters**  
 After checking the connection of filters, press the ENTER switch.

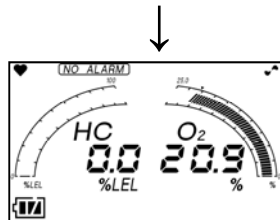


\* Until confirmed, the confirmation screens are displayed in turn as shown in the above picture.

**Warm-up**  
 Warm-up is performed for about 30 seconds.  
 The number displayed in the center of the screen starts counting down.



**Detection Mode**



\* The buzzer sounds twice (Beep, beep).



**CAUTION**

After start-up, perform air calibration before performing gas detection (See "4-7. Air calibration mode").

**NOTE**

- A sensor abnormality alarm is issued before the detection mode is entered if there is any abnormality in the sensor. Press the ▼ switch. This will reset the sensor abnormality alarm temporarily, set the gas concentration display that was abnormal on the sensor to ---, and start gas detection. However, notify the abnormality to RIKEN KEIKI promptly. Gas for which there was an abnormality in the sensor cannot be detected. However, the alarm cannot be reset if there is an abnormality in all the sensors.
- If there is an abnormality in the built-in clock, a fault alarm FAIL CLOCK may be issued. Press the ▼ switch. The fault alarm is temporarily reset, and measurement is started with incorrect clock time.

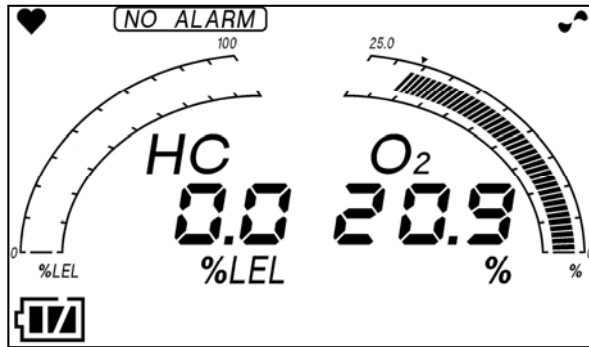
**NOTE**

At a low temperature, the pump may need to be warmed up.  
 In this case, the screen will be as shown on the right after the battery voltage is displayed (Max 60 seconds).



## 4-5. How to detect

In the detection mode, put the gas sampling probe close to the detection area and take the reading on the display.



### <- Display example

HC concentration: 0.0%LEL

O2 concentration: 20.9%

Battery level: Sufficient

\* HC: The acronym of HydroCarbons. In this gas detector, combustible gas concentration is displayed in isobutane conversion.



### DANGER

- While conducting measurement in a manhole or confined space, do not lean over or look into the manhole or closed space. It may lead to dangers because oxygen-deficient air or other gases may blow out.
- Oxygen-deficient air or other gases may blow out from the gas exhausting outlet. Never inhale the air or gases.
- High-concentration (more than LEL) gases may blow out. Never use fire near the gas detector.
- When measuring the oxygen concentration, do not measure anything but a mixture of air and combustible gases or vapors and toxic gases.



### WARNING

- The gas detector is designed to draw gases around it under the atmospheric pressure. If excessive pressure is applied to the gas inlet and outlet (GAS IN, GAS OUT) of the gas detector, detected gases may leak out from its inside and may cause dangerous conditions. Be sure that excessive pressure is not applied to the detector while used.
- Do not connect the sampling hose directly to a location with a pressure higher than the atmospheric pressure. The internal piping system may be damaged.
- When the fresh air adjustment is performed in the atmosphere, check the atmosphere for freshness before beginning the adjustment. If other gases exist, the adjustment cannot be performed properly, thus leading to dangers when the gas leaks.
- Issuance of a gas alarm indicates that there are extreme dangers. Take proper actions based on your judgment.
- Before use, check that there remains sufficient battery power. When the gas detector is used for the first time or is not used for a long period, the batteries may be exhausted. Either fully charge the batteries or replace them with new ones before use.
- If a low battery alarm occurs, gas detection cannot be conducted. If the alarm is triggered during use, turn off the power and promptly charge the batteries in a non-hazardous area.
- Do not block the buzzer sound hole. No alarm sound can be heard.



## CAUTION

- Before performing gas detection, attach the gas sampling probe provided with the gas detector to prevent disturbances by air dust.
- When you measure concentrations of oxygen in inert gases for a long time, the carbon dioxide concentration in the air must be 15% or less. When you use the gas detector in the inert gas with a carbon dioxide concentration of 15% or higher, perform measurement in as short time as possible. Using the gas detector under high concentrations for a long time may shorten the life of the oxygen sensor.

## NOTE

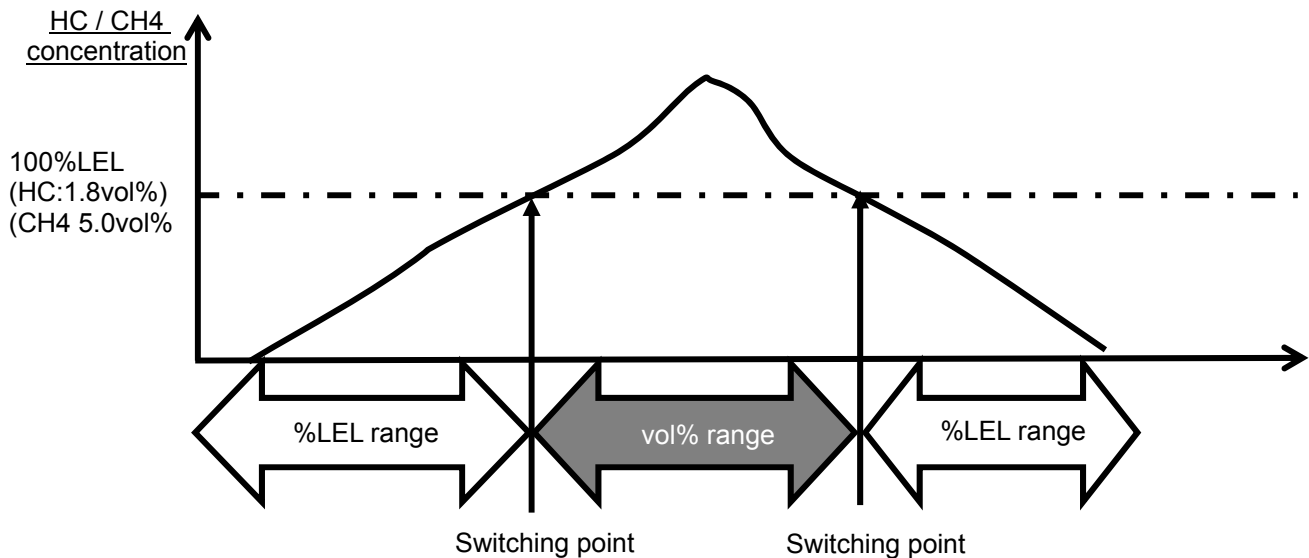
- In a low-temperature environment, the operating time is shortened due to the battery performance property.
- At a low temperature, the response of the LCD display may get slow down.
- If a combustible gas with a higher concentration than %LEL is drawn, some gas may remain in the gas sampling hose due to adsorption in the hose, gas sampling probe, etc. After drawing a high-concentration combustible gas, clean the gas detector to remove the adsorbed gas (draw fresh air and check that the reading becomes zero). Performing fresh air calibration before cleaning it completely will result in inaccurate adjustment, giving adverse influence on measurement. In such a case, remove the gas sampling hose before performing fresh air calibration to avoid inaccurate adjustment.

## NOTE

<About Range Switching Point>

The display automatically switches to the vol% range when the concentration of a detected combustible gas exceeds 100%LEL. When the concentration drops, the display returns to the %LEL range again. The following shows an example of switching timing.

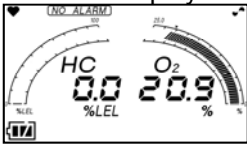
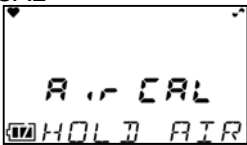
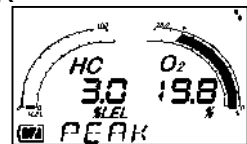

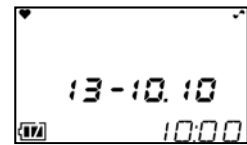
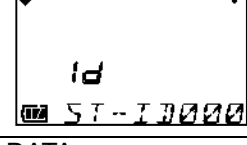

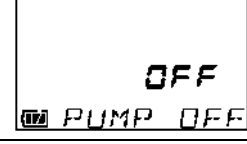
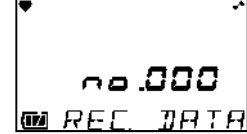
Diagram example of gas concentrations and range switching timing



\* HC: The acronym of HydroCarbons. Because combustible gas concentration is displayed in isobutane or CH4 conversion in this detector, the range switching point is LEL 1.8 vol% of isobutane or 5.0% of methane respectively.

## 4-6. Modes

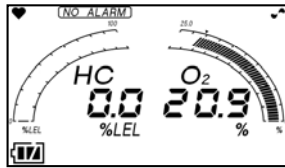
Details on each mode are provided as follows.

Mode	Item	LCD display	Details
Detection Mode	-	Concentration display 	Normal state
Air Calibration Mode	-	AIR CAL 	Performs the zero adjustment.
Display and Setting Mode	Peak Display	PEAK 	Displays the maximum concentration (or minimum concentration for oxygen display) detected during measurement from power-on to the present.
	Full Scale Display/Alarm Setpoint Display/Alarm Test [Optional Setting]	ALARM-P 	* The gas alarm function is an optional setting.
	Clock Display		Displays the current time.
	ID Display	ID 	Displays an ID if it has been set in advance. Also used to change or set an ID.
	Log Data Display	REC.DATA 	Displays data recorded to the manual memory.
Pump OFF Mode	-	PUMP OFF 	Used to turn on/off the pump operations.
Manual Memory Mode	-	REC.DATA 	Any instantaneous value can be recorded.

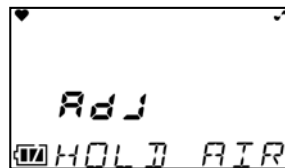
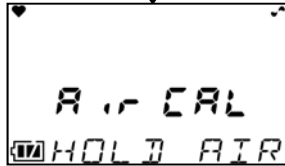
## 4-7. Air calibration mode

### Detection Mode

Keep the AIR switch pressed.



When the AIR switch is kept pressed, the display changes to AdJ - HOLD AIR.

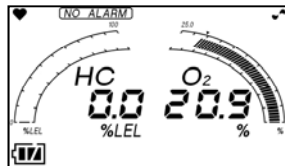


When RELEASE is displayed, release the AIR switch.



### Detection Mode

When the air calibration is successfully completed, it returns to the detection mode.



### WARNING

When the air calibration is performed in the atmosphere, check the atmosphere for freshness before beginning the air calibration. If other gases exist, the adjustment cannot be performed properly, thus leading to dangers when the gas leaks.



### CAUTION

- Perform air calibration under pressure and temperature/humidity conditions close to those in the operating environment and in fresh air.
- Perform air calibration after the reading is stabilized.
- If there is a sudden temperature change of 15°C or more between the storage and operation locations, turn on the power of the gas detector, let it leave for about 10 minutes in a similar environment to the operation location, and perform air calibration in fresh air before using it.

**NOTE**

- If the air calibration fails, FAIL - AIR CAL is displayed along with the name of gas sensor which has become faulty.
- Press the ▼ switch to reset the fault alarm (calibration failure). In this case, the value before calibration is displayed.



If HC sensor is faulty

# 4-8. Display/setting mode

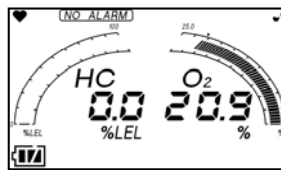
This mode allows you to change various displays and settings. Every time the PEAK switch is pressed, various screens are displayed in turn.

## NOTE

The gas detector automatically returns to the detection mode in about 20 seconds if the gas detector is left unoperated.

Detection Mode

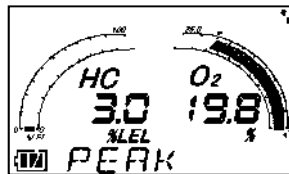
LCD display



Display/Setting Mode

Peak Display

Displays the maximum concentration (or minimum concentration for oxygen) detected during measurement from power-on to the present.



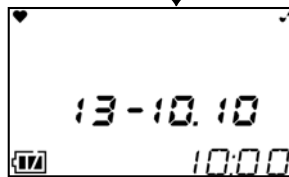
Full Scale Display/Alarm Setpoint

Display/Alarm Test [Optional setting]



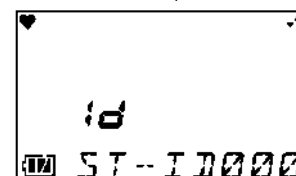
\* The gas alarm function is an optional setting.

Clock Display



ID Display/Selection

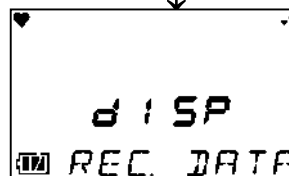
Displays an ID if it has been registered in advance. Also used to select an ID.



→ ID Display/Selection  
ENTER switch => P27

Log Data Display

Displays concentration data recorded to the manual memory.



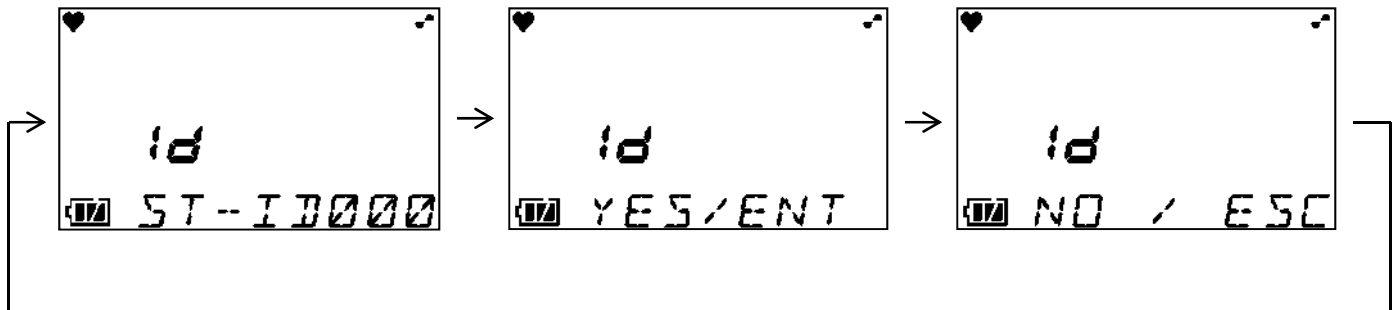
→ Log Data Display  
ENTER switch => P28

To Detection Mode

## <ID Display/Selection "ID SELECT">

Display and select an ID that has been registered in advance.

- (1) Press the PEAK switch and select the ID display/selection from the display/setting mode menu.  
The following screens are displayed in turn on the gas detector.

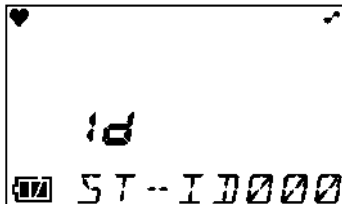


- (2) Press the ENTER switch to set or select an ID.

### NOTE

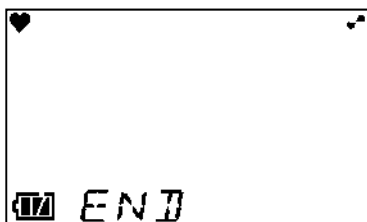
- If you do not want to set or select an ID, press the ESC switch to return to the display/setting mode menu.
- On the gas detector, either of the IDs from ST-ID000 to ST-ID127 has been registered, unless otherwise specified.
- The data logger management program (option) is required to register or change an ID. Please contact RIKEN KEIKI.

- (3) Press either the ▲ or ▼ switch to select an ID.  
Every time the ▲ or ▼ switch is pressed, the ID number increases or decreases (000-127).



Display example

- (4) Press the ENTER switch.  
(5) When END is displayed, the setting is completed.



The display/setting mode menu is displayed again.

- (6) After completion, press the PEAK switch several times until it returns to the detection mode.

## <Log Data Display "REC.DATA">

Display concentration data recorded to the manual memory.

- (1) Press the PEAK switch and select the log data display from the display/setting mode menu. The following screens are displayed in turn on the gas detector.

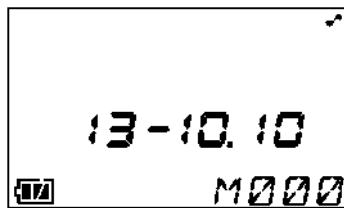


- (2) Press the ENTER switch to display the log data.

### NOTE

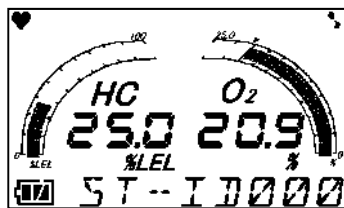
If you do not want to display the log data, press the ESC switch to return to the display/setting mode menu.

- (3) Every time the ▲ or ▼ switch is pressed, the log data menus are displayed in turn. Press either the ▲ or ▼ switch to select log data that you want to check. The log data menu displays the year, month, day, time, and memory number.



Display example

- (4) Press the ENTER switch to display the selected log data.



Display example

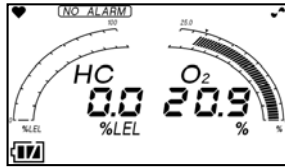
- (5) If you want to display other log data, press the ENTER switch to return to the log data menu. Repeat the steps (3) to (5).
- (6) After completion, press the PEAK switch several times until it returns to the detection mode.

## 4-9. Pump OFF mode

This mode allows you to stop the pump operation only.

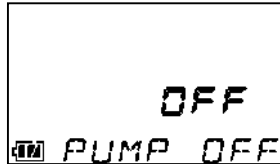
### Detection Mode

Keep the PUMP switch pressed for about three seconds to stop the pump operation only.



### Pump OFF Mode

Only the pump operation is stopped. Press the PUMP switch shortly to resume the pump operation.



### WARNING

- When PUMP OFF is set, no alarm is triggered whatever happens.
- The gas detector does not automatically return to the detection mode if PUMP OFF is set.

### NOTE

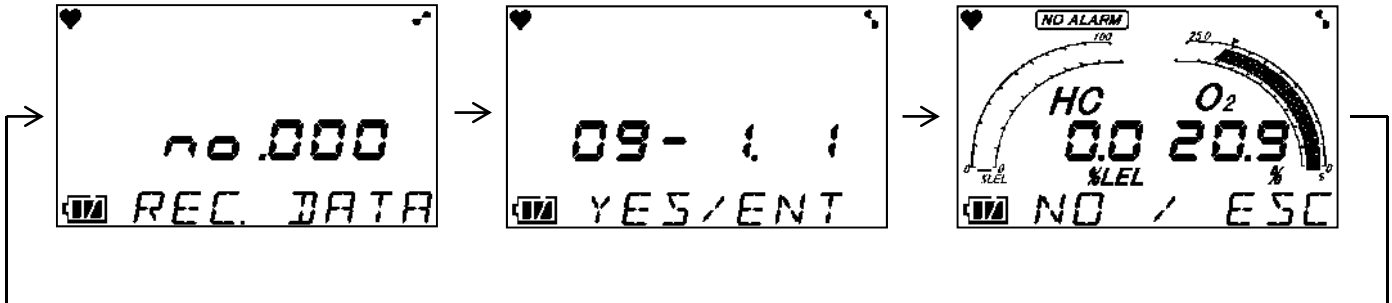
When the pump operation is stopped, the buzzer sounds twice (beep, beep) about every three minutes.

## 4-10. Manual memory mode

Any instantaneous value during measurement can be recorded.

Up to 256 points of data can be recorded. When the number of recorded data points reaches the maximum, recorded data will be overwritten, starting from the oldest data.

(1) In the detection mode, press the PEAK and ▲ switches simultaneously for about a second to enter the manual memory mode. The following screens are displayed in turn on the gas detector.



### NOTE

- The screen displays the memory number, date, and instantaneous value in turn. Go to the next step to execute recording. No value is recorded at this point yet. If you do not want to record a value, press the ESC switch to return to the detection mode.
- If the Display and Setting Mode or Air Calibration Mode screen is displayed because the timing of pressing the PEAK and ▲ switches is off, release the both switches and then try again.

(2) Press the ENTER switch. The date and the instantaneous value at the time when the ENTER switch is pressed are recorded.

(3) When END is displayed, the recording is completed.



It automatically returns to the detection mode.

## 4-11. How to exit

Make the gas detector draw in fresh air. After the display returns to zero (or 20.9% for oxygen), keep the POWER switch pressed until the power is turned off.

### NOTE

If the display is not zero when the power is turned off, a purge operation may be performed for 30 seconds at the maximum to clean the inside of the gas detector.



## 5

# Operations and Functions

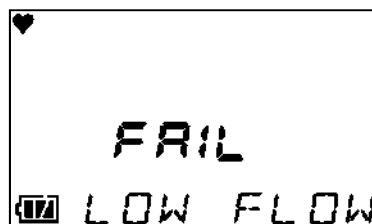
## 5-1. Fault alarm pattern

Fault alarm: Triggered when an abnormality is detected in the gas detector. <<Self-latching>>  
 Alarm display: Notifies by display of error messages, sounding of the buzzer, and lighting of the lamp.  
 Alarm types: Low flow rate, sensor abnormality, battery voltage low, system abnormality, and calibration failure

Determine the causes and take appropriate actions.  
 If the gas detector has problems and is repeatedly malfunctioning, contact RIKEN KEIKI immediately.

### <Display Operation>

LCD display	Displays an error message.
Alarm lamp	Repeatedly blinks at about one second intervals.
Buzzer	Repeatedly sounds intermittent beeps at about one second intervals: Blip, beep, blip, beep



Display example



### CAUTION

- When in FAIL LOW FLOW, the pump stops working for pump protection.
- To reset a low flow rate alarm (FAIL LOW FLOW), remove the cause of the low flow fail, and then press the RESET switch. In case pushing RESET switch without removing cause of the low flow fail, the pump re-start working and water or other material might be sucked inside detector.

### NOTE

- For information on malfunctions (error messages), see "8. Troubleshooting".

## 5-2. Other functions

### <Calibration History/Various Trend/Event History Functions>

The gas detector has history and trend functions. To use these functions, please contact RIKEN KEIKI.

**NOTE**

The data logger management program (option) is required to use the history and trend functions. Please request RIKEN KEIKI.

## 6

# Maintenance

The gas detector is an important instrument for the purpose of safety. To maintain the performance of the gas detector and improve the reliability of safety, perform a regular maintenance.

## 6-1. Maintenance intervals and items

- Daily maintenance: Perform maintenance before beginning to work.
- Monthly maintenance: Perform alarm test once a month.
- Regular maintenance: Perform maintenance once or more every six months to maintain the performance as a safety unit.

Maintenance item	Maintenance content	Daily maintenance	Monthly maintenance	Regular maintenance
Battery level check	Check that the battery level is sufficient.	○	○	○
Concentration display check	Make the gas detector draw in fresh air. Check that the concentration display value is zero (or 20.9 vol% on the oxygen deficiency meter). When the reading is incorrect, perform the air calibration after ensuring that no other gases exist around it.	○	○	○
Flow rate check	See the flow rate indicator to check for abnormalities.	○	○	○
Filter check	Check the dust filter for dust or clogging.	○	○	○
Span adjustment	Perform the span adjustment by using the calibration gas.	-	-	○

### <About Maintenance Services>

- We provide services on regular maintenance including span adjustment, other adjustments and maintenance.  
To make the calibration gas, dedicated tools, such as a gas cylinder of the specified concentration and gas sampling bag must be used.  
Our qualified service engineers have expertise and knowledge on the dedicated tools used for services, along with other products. To maintain the safety operation of the indicator/alarm unit, please use our maintenance service.
- The followings are typical maintenance services. For details, please contact RIKEN KEIKI.

Main services

- Battery level check : Checks the battery level.
- Concentration display check : Verifies that the concentration display value is zero (or 20.9 vol% on the oxygen deficiency meter) by using the zero gas.  
Performs the air calibration if the reading is incorrect.
- Flow rate check : Checks the flow rate indicator to find abnormalities.  
Checks the flow rate by using an external flow meter to verify the correctness of the flow rate indicator on the gas detector. If the flow rate is incorrect, performs the flow rate adjustment.
- Filter check : Checks the dust filter for dust or clogging.  
Replaces a dirty or clogged dust filter.
- Span adjustment : Performs the span adjustment by using the calibration gas.
- Cleaning and repair of device (visual diagnosis) : Checks dust or damage on surface of the gas detector, cleans and repairs such parts of the gas detector.  
Replaces parts which are cracked or damaged.
- Device operation check : Uses the keys to check the operation of functions and parameters.
- Replacement of consumable parts : Replaces consumable parts, such as a sensor, filter and pump.

## 6-2. Gas calibration

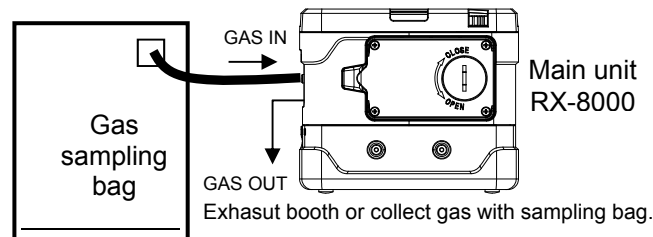
Perform span adjustment of sensors using a calibration gas at least once every six months. The span adjustment requires dedicated equipment and a calibration gas. Request RIKEN KEIKI for it.

### <Required Equipment/Material>

- Calibration gas (low-concentration combustible gas for %LEL and high-concentration combustible gas for vol%)
- Calibration gas (nitrogen gas for O<sub>2</sub>)
- Set of gas sampling bags (for %LEL and vol%)
- Set of gas sampling bags (for O<sub>2</sub>)

### <Connection>

Connect the equipment as shown below to perform the span adjustment.



### WARNING

#### About the span gas

The span gas is a hazardous gas (combustible, toxicity, oxygen deficient, etc.). Handle the gas and related jigs and tools with due care.

\* Inhaling the gas must be avoided, the gas sampling bag must be free of holes, etc.

#### About the place for span adjustment

- Perform span adjustment where no silicon, organic solvent, spray can gases, etc. is used.
- Perform span adjustment indoors at normal temperatures without remarkable fluctuation (within  $\pm 5^{\circ}\text{C}$ ).
- Perform span adjustment in an exhaust booth or collect exhaust gas with sampling bag.



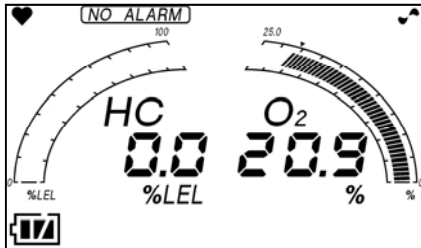
### CAUTION

The gas outlet (GAS OUT) must be left open without any pipe connected for atmosphere release.

## <Span Adjustment>

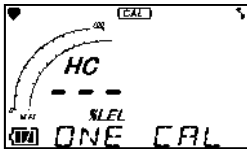
Perform the span adjustment using the procedure shown below.

- (1) Prepare the calibration gases (for %LEL, vol%, and O<sub>2</sub>) and a set of gas sampling bags.
- (2) Remove the filter tube, gas sampling hose, etc. to allow the gas sampling bag to be directly connected to the gas inlet (GAS IN).
- (3) Check that the gas detector is in the detection mode.

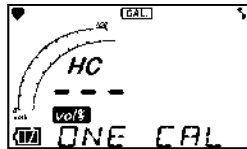


Detection Mode

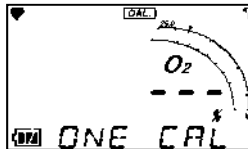
- (4) Perform the air calibration. \* See "4-7. Air calibration mode".
- (5) Collect each calibration gas in each gas sampling bag.
- (6) Press the ▲ and ▼ switches simultaneously for about a second to enter the span adjustment mode (ONE CAL).



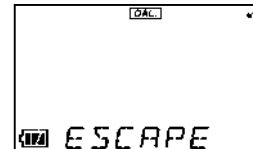
HC %LEL adjustment



HC vol% adjustment



O<sub>2</sub> adjustment



ESCAPE



### WARNING

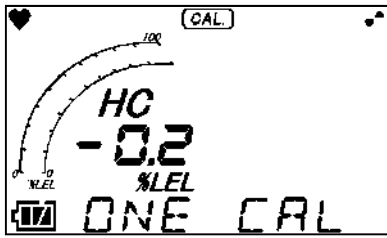
After the adjustment is completed, do not forget to return to the detection mode.  
(If the monitor remains in the regular maintenance mode, it does not automatically return to the detection mode.)

### NOTE

- If the Air Calibration Mode screen is displayed because the timing of pressing the ▲ and ▼ switches is off, release the both switches and then try again.
- In the span adjustment mode, select the concentration display that can be adjusted with the ▲ or ▼ switch.
- Press the ESC switch to abort the running operation.
- To return from the span adjustment mode to the detection mode, select ESCAPE and then press the ENTER switch.

- (7) Use the ▲ or ▼ switch to select HC %LEL.

Press the ENTER switch to enter the HC %LEL span adjustment mode. \* The concentration display blinks.

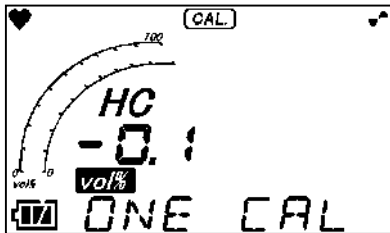


- (8) Connect the gas sampling bag in which the %LEL calibration gas was collected to the gas inlet to supply the gas to the gas detector. Wait for the concentration display value to be stabilized.
- (9) When it is stabilized, adjust the concentration display value to calibration gas concentration value by pressing the ▲ or ▼ switch. Press the ENTER switch to confirm it. When END is displayed, the HC %LEL span adjustment is completed. Remove the gas sampling bag.

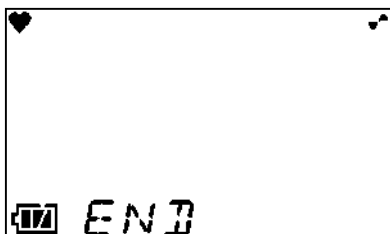


- (10) Then, use the ▲ or ▼ switch to select HC vol%.

Press the ENTER switch to enter the HC vol% span adjustment mode. \* The concentration display blinks.

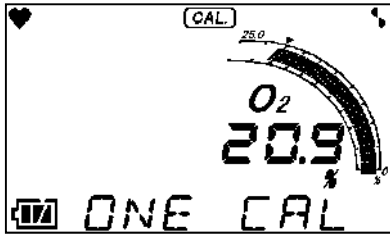


- (11) Connect the gas sampling bag in which the vol% calibration gas was collected to the gas inlet to supply the gas to the gas detector. Wait for the concentration display value to be stabilized.
- (12) When it is stabilized, adjust the concentration display value to calibration gas concentration value by pressing the ▲ or ▼ switch. Press the ENTER switch to confirm it. When END is displayed, the HC vol% span adjustment is completed. Remove the gas sampling bag.



(13) Then, use the ▲ or ▼ switch to select O<sub>2</sub>.

Press the ENTER switch to enter the O<sub>2</sub> span adjustment mode. \* The concentration display blinks.



(14) Connect the gas sampling bag in which the O<sub>2</sub> calibration gas was collected to the gas inlet to supply the gas to the gas detector. Wait for the concentration display value to be stabilized.

(15) When it is stabilized, adjust the concentration display value to calibration gas concentration value by pressing the ▲ or ▼ switch. Press the ENTER switch to confirm it. When END is displayed, the O<sub>2</sub> span adjustment is completed. Remove the gas sampling bag.



(16) Use the ▲ or ▼ switch to select ESCAPE.

Press the ENTER switch to return to the detection mode. Exit the span adjustment.

## 6-3. How to clean

Clean the gas detector if it becomes extremely dirty. The gas detector must be turned off while cleaning it. Use a waste cloth to remove dust. Do not use water or organic solvent for cleaning because they may cause malfunctions.

Because an extremely large amount of dust inside the gas sampling hose may disturb the gas detection, it must be cleaned with dry air, etc.



### CAUTION

When cleaning the gas detector, do not splash water over it or use organic solvents such as alcohol and benzene on it. The surface of the gas detector may be discolored or damaged.

### NOTE

When the gas detector gets wet, water may remain in the buzzer sound opening or clearances. Drain water as follows:

- (1) Wipe away moisture on the gas detector thoroughly using a dry towel, cloth, etc.
- (2) While holding the gas detector firmly, shake it about ten times with the buzzer sound opening facing downward.
- (3) Wipe away moisture coming out from the inside thoroughly using a towel, cloth, etc.
- (4) Place the gas detector on a dry towel, cloth, etc. and let it stand at normal temperatures.

# 6-4. Parts replacement

## <Replacement of Consumables>

### Sensor Replacement

The built-in sensors of the gas detector have a validity period and must be replaced regularly (within one year).

The sensor life has expired if, for example, the sensors cannot be calibrated in span adjustment, the readings do not come back after fresh air calibration, or the readings fluctuate. Request RIKEN KEIKI for repair. Recommended replacement intervals are five years for the combustible gas sensor and one year for the oxygen sensor.


### Dust Filter Replacement Procedure

Because the dust filter may gradually get dirty or clogged over the time, it must be replaced regarding the operating conditions. Check the dust filter, and then replace it as necessary.

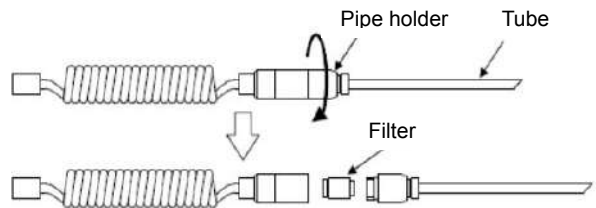
### Gas sampling probe

The gas sampling probe has a built-in dust filter. Replace the filter when it has absorbed water, has a low flow rate, or looks significantly contaminated.

- (1) Hold the transparent part and turn the tip (white) to remove it.
- (2) Take out the filter from the transparent part and insert a new filter.



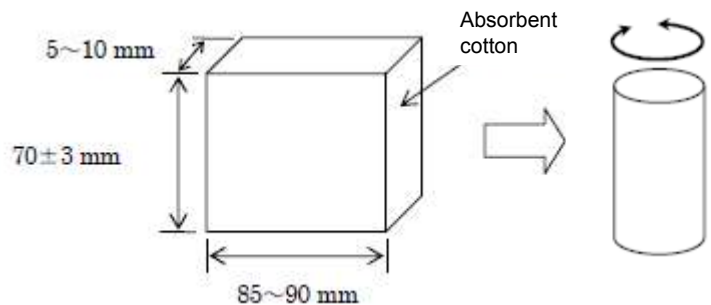
**CAUTION**  
Make sure that the filter is inserted in correct orientation.



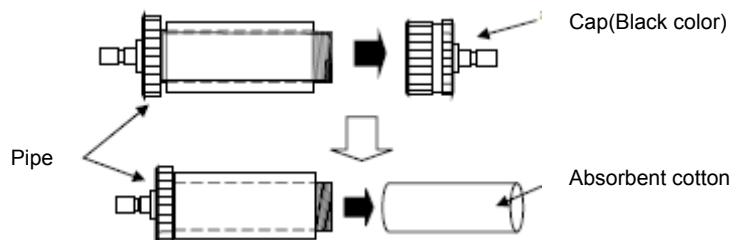
- (3) Attach the tip that has been removed.

### Dry cotton inside CF-8385 Replacement Procedure

- 1) Cut dry cotton with the size listed left.  
(Weight approx 1.3g)



- 2) Loosen and remove the cap.
- 3) Replace dry cotton to new one, and fill the interspace with dry cotton
- 4) Tighten the cap again.

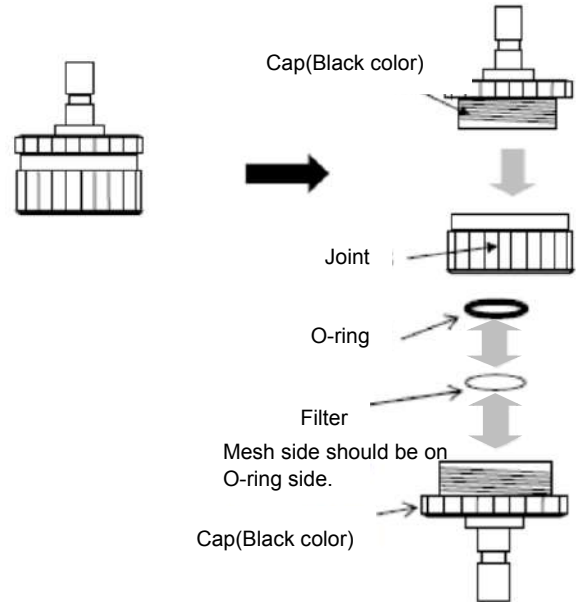


**Water proof filter Replacement Procedure**

(1) Loosen the cap(black color).

(2) Remove the filter and replace to new one.

(3) Tighten the cap again.

**<Replacement of Regular Replacement Parts>**

List of recommended regular replacement parts

Item	Maintenance intervals	Replacement intervals	Quantity (pieces per unit)	Remarks
Internal filter	6 months	6 months - 1 year	1	*
Dust filter (for the gas sampling probe)	6 months	6 months - 1 year	1	Part number 0904 0257 60
Water-proof filter (10 pcs for filter tube)	6 months	6 months - 1 year	1	Part number 4777 9022 50
Absorbent cotton (25 g for filter tube)	6 months	6 months - 1 year	1.3 g	Part number 1879 0011 10
Tubes	6 months	3 - 8 years	A set	*
Combustible gas sensor (DE-3123-4 / DE-3113-13)	6 months	5 years	1	*
Oxygen sensor (OS-BM1)	6 months	1 year	1	*
Pump unit (RP-11)	6 months	1 - 2 years	1	*
Rubber seals	-	2 years	A set	*
Li-ion battery pack (for BUL-8000(R), BUL-8000(R1))	-	-	1	About 500 cycles of charging and discharging *
Alkaline dry battery	-	-	3	AA

\* The operation must be checked after replacement by a qualified service engineer. For the stable operation of the gas detector and safety, ask a qualified service engineer to take care of replacement of the parts whose operation must be checked. Request RIKEN KEIKI for operation check.

**NOTE**

The above replacement intervals are recommendation only. The intervals may change depending on the operating conditions. These intervals do not mean the warranty periods either. The result of the daily or regular maintenance may determine when to replace the parts.

## 7

# Storage and Disposal

## 7-1. Procedures to store the gas detector or leave it for a long time

The gas detector must be stored under the following environmental conditions.

- In a dark place under the normal temperature and humidity away from direct sunlight
- In a place where gases, solvents or vapors are not present

Store the gas detector in a shipping carton, if any, in which the product was delivered. Store the gas detector away from dust, etc. if the shipping carton is not available.



### WARNING

- If the gas detector with a dry battery unit is not used for a long time, store it after removing the batteries. Battery leaks may result in fire or injury. If the gas detector is not used for a short time, store it without removing the batteries. While the power of the gas detector is OFF, the sensor is energized at all times. Therefore, it is necessary to store the gas detector with the batteries in it.



### CAUTION

If the gas detector is not used for a long time, turn on the power at least once every six months and check that the pump draws in air (about three minutes). The gas detector, when not activated for a long time, may cease to work because of hardening of the grease in the pump motor.

### NOTE

- If the gas detector with a lithium ion battery unit is not used for a long time, it is recommended to store it after discharging the batteries until the battery level icon shows one battery mark or so. If the gas detector is stored with the batteries fully recharged, the batteries get deteriorated more quickly and may have shorter life.

## 7-2. Procedures to use the gas detector again



### CAUTION

When you use a stopped or stored gas detector again, never fail to perform a gas calibration. For information on readjustment including gas calibration, please contact RIKEN KEIKI.

## 7-3. Disposal of products

- When the gas detector is disposed of, it must be treated properly as an industrial waste in accordance with the local regulations.



### WARNING

- Do not disassemble the galvanic cell type sensor because it contains electrolyte. Electrolyte may cause severe skin burns if it contacts skin, while it may cause blindness if its contacts eyes. If electrolyte is adhered on your clothes, that part on your clothes is discolored or its material is decomposed. If contact occurs, rinse the area immediately with a large quantity of water.
  - Dispose the batteries in accordance with procedure specified by the local authority.
- When disposing of the gas detector in EU member states, sort the batteries as specified. Handle the removed batteries according to the classified refuse collection system and recycling system based on the regulations of EU member states. Contact RIKEN KEIKI for disposal.

#### Removing batteries

See Section 4-2 "Preparation for start-up" and take out the batteries.

For BUL-8000(R), BUL-8000(R1)

Model	Type
BUL-8000(R) BUL-8000(R1)	Lithium ion battery

### NOTE

- BUL-8000(R), BUL-8000(R1) contains batteries.
- Crossed-out recycle dustbin mark



This symbol mark is indicated on the products which contain the batteries which fall under EU Battery Directive 2006/66/EC. Such batteries need to be disposed of as specified by the latest Directive. This symbol mark indicates that the batteries need to be separated from the ordinary waste and disposed of appropriately.

# Troubleshooting

The troubleshooting does not explain the causes of all the malfunctions which occur on the gas detector. This simply helps to find the causes of malfunctions which frequently occur. If the gas detector shows a symptom which is not explained in this manual, or still has malfunctions even though remedial actions are taken, please contact RIKEN KEIKI.

## <Abnormalities on Unit>

Symptoms	Causes	Actions
<u>The power cannot be turned on.</u>	The battery level is too low.	Lithium ion battery unit: Charge the battery unit in a non-hazardous area. Dry battery unit: Replace all the three dry batteries with the new ones in a non-hazardous area.
	The power switch was not pressed long enough.	For power-on, keep the POWER switch pressed until a beep is heard (about two seconds).
	Improper installation of the battery unit	Check whether the battery unit is properly attached to the main unit.
<u>Abnormal operations</u>	Disturbances by sudden surge noise, etc.	Turn off and restart the indicator/alarm unit.
<u>Key operations are disabled.</u>	Disturbances by sudden surge noise, etc.	In a non-hazardous area, remove the battery unit once, and reinstall the battery unit, and turn on the power to perform operations.
<u>System abnormalities</u> <b>FAIL SYSTEM</b>	A circuit abnormality occurred.	Request RIKEN KEIKI for repair.
<u>Sensor abnormalities</u> <b>FAIL SENSOR</b>	A sensor has failed.	Request RIKEN KEIKI to replace the sensor. (Only at power-on, press the RESET switch to continue the operation using gas sensors except the sensor which has failed.)
<u>A low battery voltage alarm is triggered.</u> <b>FAIL BATTERY</b>	The battery level is low.	Lithium ion battery unit: Turn off the power and charge the battery unit in a non-hazardous area.
		Dry battery unit: Turn off the power and replace the dry batteries with new ones in a non-hazardous area.
<u>A low flow rate alarm is triggered.</u> <b>FAIL LOW FLOW</b>	Water or oil, etc. was drawn in.	Check the gas sampling hose for any damage or mark of drawn water or oil, etc.
	The gas sampling hose is clogged.	Check the gas sampling hose for connections, clogging, twisting, etc.
	The gas detector was powered on at a low temperature or has not been used for a long time.	Turn on the power several times. The pump may start operating.
	The pump has deteriorated.	Request RIKEN KEIKI to replace the pump.

<u>Air calibration impossible</u> <u>FAIL AIR CAL</u>	Fresh air is not supplied around the gas detector.	Supply fresh air.
<u>Clock abnormalities</u> <u>FAIL CLOCK</u>	Abnormalities of the internal clock	Make a setting of Date/Time. If such a symptom is observed repeatedly, the built-in clock is seemingly malfunctioning. Thus, it must be replaced. Request RIKEN KEIKI for replacement.
<u>The batteries cannot be recharged.</u> <u>(Lithium ion battery unit only)</u>	The charger is not connected properly.	Connect the AC powered charger to the wall electric outlet and jack properly.
	A charging circuit abnormality occurred.	Request RIKEN KEIKI for repair.
	The batteries have been fully charged.	When fully charged batteries are charged again, the charging indicator lamp does not go on.

## &lt;Abnormalities of Readings&gt;

Symptoms	Causes	Actions
<u>The reading rises (drops) and it remains so.</u>	Drifting of sensor output	Perform the air calibration.
	Presence of interference gas	Check if any interference gas, such as solvent, etc., is present and take an appropriate action.
	Slow leak	A very small amount of the gas to be detected may be leaking (slow leak). Ignoring it may cause dangers.
	Environmental changes	Perform the air calibration. In particular, the galvanic cell type is affected by the air pressure.
<u>Slow response</u>	Clogged dust filter	Replace the dust filter.
	Bended or clogged gas sampling hose	Fix the defective parts.
	Condensation is formed inside the gas sampling hose.	Fix the defective parts.
	Deteriorated sensor sensitivity	Replace the sensor with a new one.
<u>Span adjustment impossible</u>	Improper calibration gas concentration	Use the proper calibration gas.
	Deteriorated sensor sensitivity	Replace the sensor with a new one.

## 9

# Product Specifications

## 9-1. List of specifications

Detection principle	Galvanic cell type (OS)	Non-dispersive infrared type (RI)
Gas to be detected	Oxygen (O <sub>2</sub> )	Combustible gas (HC or CH <sub>4</sub> ) *1
Detection range <Service range>	0 to 25 vol% <to 40 vol%>	0 to 100%LEL/to 100 vol%
Display resolution	0.1 vol%	0.5%LEL (to 100%LEL)/0.5vol% (to 100 vol%)
Accuracy of the reading (under an identical condition)	Within $\pm 0.7$ vol%	Within $\pm 5\%$ LEL (to 100%LEL) Within $\pm 5\%$ vol% or $\pm 10\%$ of the reading (to 100 vol%)
Response time (under an identical condition)	90% response: within 20 seconds *2	90% response: within 30 seconds *2
	90% response: within 2 minutes *3	90% response: within 2 minutes *3
Concentration display	LCD digital (seven-segment + Symbol + Bar meter)	
Detection method	Pump suction type	
Suction flow rate	0.75 L/min or more (Open flow rate)	
Displays	Battery level icon, pilot indicator, and pump operation status indicator	
Buzzer sound volume	95 dB (A) or higher (30 cm)	
Fault alarm/self diagnosis	System abnormalities, sensor abnormalities, battery voltage drop, calibration failure, and low flow rate	
Fault alarm display	Lamp blinking, intermittent buzzer sounding, and detail display	
Fault alarm pattern	Self-latching	
Transmission specifications	IrDA (for data logger)	
Functions	LCD backlight, data logger, peak display, log data display, and pump stop	
Power supply	Dedicated lithium ion battery unit [BUL-8000(R), BUL-8000(R1)] (Dedicated dry battery unit <AA alkaline dry batteries x 3> [BUD-8000(R)] can also be used.)	
Continuous operating time	BUL-8000(R), BUL-8000(R1): About 15 hours (25°C, no alarm, no lighting, and battery fully charged) BUD-8000(R): About 10 hours (25°C, no alarm, and no lighting)	
Operating temperatures	-20 to +50°C	
Operating humidities	Below 95% RH (Non-condensing)	
Structure	Drip-proof and dust-proof performances (compliant to IP67 level)	
Explosion-proof structure	Intrinsically safe explosion-proof structure	

Explosion-proof class	EXiaIICT4X(TIIS) / II1GEExIICT4Ga(ATEX/IECEEx<DEKRA>)
Explosion-proof certification number	No.TC20782 (TIIS) / DEKRA13ATEX0228(ATEX)/IECEExDEK13.0091(IECEEx)
External dimensions	Approx. 154 (W) x 81 (H) x 127 (D) mm (projection portions excluded)
Weight	About 1.1 kg (when BUL-8000(R), BUL-8000(R1) is used) or about 1.0 kg (when BUD-8000(R) is used)

- \*1 HC: The acronym of HydroCarbons. In this gas detector, combustible gas concentration is displayed in isobutane conversion.
- \*2 When introducing the gas from the gas inlet of the main unit
- \*3 When introducing the gas from the tip of the gas sampling hose (30 m) (option)
- \*4 In order to meet requirement about explosion-proof, use dedicated dry cell battery when using BUD-8000.

## 9-2. List of accessories

Standard accessories	<ul style="list-style-type: none"> <li>• Lithium ion battery unit (BUL-8000(R), BUL-8000(R1)): 1 (Attached to the main unit)</li> <li>• AC powered charger: 1</li> <li>• Gas sampling probe and gas sampling hose: 1</li> <li>• Filter tube: 1</li> <li>• Relay tube: 1</li> <li>• Shoulder strap: 1</li> <li>• Filter tube fixing belt: 1</li> <li>• Operating manual</li> <li>• Product warranty</li> </ul>
Optional accessories	<ul style="list-style-type: none"> <li>• Dry battery unit (BUD-8000(R))</li> <li>• AA size alkaline battery</li> <li>• Waist strap</li> <li>• Waist strap fixing tool</li> <li>• Carrying case (leather)</li> <li>• Sampling probe holder</li> <li>• Aluminum trunk case</li> <li>• Shipboard storage box (metal: non-compliant Rohs )</li> <li>• Gas sampling hose (with float probe, 8 m)</li> <li>• Gas sampling hose 30 m with plummet</li> <li>• Water trap filter</li> <li>• Relay tube</li> <li>• Filters for CF-8385 (10pcs / 1set)</li> <li>• Set of gas sampling bags (for %LEL/vol%)</li> <li>• Span cans (supplying only for Japan Domestic )</li> <li>• Demand flow valve</li> <li>• Replacement plug for AC adaptor (Europe round-type / UK-type / Australian-type)</li> <li>• Data logger management program</li> <li>• LCD protection film</li> </ul>



### WARNING

Please be sure to connect filter tube (CF-8385), when you use Gas sampling hose 30m with plummet. If not, when in sucking water, water might go inside RX-8000 mainbody and cause the system trouble.

# Definition of Terms

vol%	Gas concentration indicated in the unit of one-hundredth of the volume
LEL	The acronym of Lower Explosion Limit. LEL refers to the lowest concentration of a combustible gas in air capable of causing explosion when ignited.

