

A-Frame Fault Locator

Model FT-103 Transmitter and Model FR-30 Receiver



• Français – 15

• Castellano – pág. 33

Table of Contents

Recording Form for Machine Serial Number	1
Safety Symbols	2
General Safety Rules	
Work Area Safety	2
Electrical Safety	2
Personal Safety	2
Equipment Use and Care	2
Service	3
Specific Safety Information	
A-Frame Fault Locator Safety	3
RIDGID Contact Information	4
Description	4
Transmitter	4
Receiver	5
Specifications	5
Standard Equipment	6
Changing/Installing Batteries	6
Transmitter	7
Receiver (A-Frame)	7
Pre-Operation Inspection	7
Set-Up And Operation Instructions	7
Fault Locating	
Connecting Transmitter	8
Locating	9
Locating Below Paved Surfaces	10
Multiple Faults	11
Path Locating	
Direct Connect Path Locating Method	11
Inductive Clamp Path Locating	12
Broadcast Inductive Path Locating	12
Storage	13
Maintenance	
Cleaning	13
Calibration	13
Service And Repair	13
Optional Equipment	14
Disposal	14
Battery Disposal	14
EC Declaration of Conformity	14
FCC Statement	14
Electromagnetic Compatibility (EMC)	14
Lifetime Warranty	Back Cover

*Original Instructions - English

A-Frame Fault Locator

A-Frame Fault Locator Model FT-103 Transmitter and Model FR-30 Receiver



⚠ WARNING!

Read this Operator's Manual carefully before using this tool. Failure to understand and follow the contents of this manual may result in electrical shock, fire and/or serious personal injury.

A-Frame Fault Locator

Record Serial Number below and retain product serial number which is located on nameplate.

Serial
No.

Safety Symbols

In this operator's manual and on the product, safety symbols and signal words are used to communicate important safety information. This section is provided to improve understanding of these signal words and symbols.

 This is the safety alert symbol. It is used to alert you to potential personal injury hazards. Obey all safety messages that follow this symbol to avoid possible injury or death.

 **DANGER** DANGER indicates a hazardous situation which, if not avoided, will result in death or serious injury.

 **WARNING** WARNING indicates a hazardous situation which, if not avoided, could result in death or serious injury.

 **CAUTION** CAUTION indicates a hazardous situation which, if not avoided, could result in minor or moderate injury.

 **NOTICE** NOTICE indicates information that relates to the protection of property.



This symbol means read the operator's manual carefully before using the equipment. The operator's manual contains important information on the safe and proper operation of the equipment.



This symbol means always wear safety glasses with side shields or goggles when handling or using this equipment to reduce the risk of eye injury.



This symbol indicates the risk of electrical shock.

General Safety Rules

WARNING

Read all safety warnings and instructions. Failure to follow the warnings and instructions may result in electric shock, fire and/or serious injury.

**SAVE ALL WARNINGS
AND INSTRUCTIONS FOR
FUTURE REFERENCE!**

Work Area Safety

- **Keep your work area clean and well lit.** Cluttered or dark areas invite accidents.
- **Do not operate equipment in explosive atmospheres, such as in the presence of flammable liquids, gases or dust.** Equipment can create sparks which may ignite the dust or fumes.
- **Keep children and by-standers away while operating equipment.** Distractions can cause you to lose control.

Electrical Safety

- **Avoid body contact with earthed or grounded surfaces such as pipes, radiators, ranges and refrigerators.** There is an increased risk of electrical shock if your body is earthed or grounded.
- **Do not expose equipment to rain or wet**

conditions. Water entering equipment will increase the risk of electrical shock.

Personal Safety

- **Stay alert, watch what you are doing and use common sense when operating equipment. Do not use equipment while you are tired or under the influence of drugs, alcohol or medication.** A moment of inattention while operating equipment may result in serious personal injury.
- **Use personal protective equipment.** Always wear eye protection. Protective equipment such as dust mask, non-skid safety shoes, hard hat or hearing protection used for appropriate conditions will reduce personal injuries.
- **Do not overreach. Keep proper footing and balance at all times.** This enables better control of the power tool in unexpected situations.
- **Do not let familiarity gained from frequent use of tools allow you to become complacent and ignore tool safety principles.** A careless action can cause severe injury within a fraction of a second.

Equipment Use and Care

- **Do not force equipment. Use the correct equipment for your application.** The cor-

rect equipment will do the job better and safer at the rate for which it is designed.

- **Do not use equipment if the switch does not turn it ON and OFF.** Any tool that cannot be controlled with the switch is dangerous and must be repaired.
- **Remove the battery pack from the equipment before making any adjustments, changing accessories, or storing.** Such preventive safety measures reduce the risk of injury.
- **Store idle equipment out of the reach of children and do not allow persons unfamiliar with the equipment or these instructions to operate the equipment.** Equipment can be dangerous in the hands of untrained users.
- **Maintain equipment.** Check for missing parts, breakage of parts and any other condition that may affect the equipment's operation. If damaged, have the equipment repaired before use. Many accidents are caused by poorly maintained equipment.
- **Use the equipment and accessories in accordance with these instructions, taking into account the working conditions and the work to be performed.** Use of the equipment for operations different from those intended could result in a hazardous situation.
- **Keep handles and grasping surfaces dry, clean and free from oil and grease.** Slippery handles and grasping surfaces do not allow for safe handling and control of the tool in unexpected situations.

Service

- **Have your equipment serviced by a qualified repair person using only identical replacement parts.** This will ensure that the safety of the tool is maintained.

Specific Safety Information

WARNING

This section contains important safety information that is specific to this tool.

Read these precautions carefully before using the RIDGID® A-Frame Fault Locator to reduce the risk of electrical shock or serious personal injury.

SAVE ALL WARNINGS AND INSTRUCTIONS FOR FUTURE REFERENCE!

Keep this manual with the tool for use by the operator.

A-Frame Fault Locator Safety

- **Do not expose the equipment to water or rain.** This increases the risk of electrical shock.
- **Do not operate the transmitter if operator or transmitter is standing in water.** Operating transmitter while in water increases the risk of electrical shock.
- **Do not connect to live voltage or active utility lines.** Disconnect the conductor to be tested from any other service, components, or anything that might be affected by high voltage. De-energize any circuits in or around the work area.
- **Always attach transmitter test leads before turning unit ON and turn unit OFF before disconnecting leads.** This will reduce the risk of electrical shock.
- **Never turn transmitter ON when anyone is touching the conductor, ground stake, or any part of the transmitter.** Turn OFF transmitter before touching test lead or any un-insulated conductor.
- **Do not use where a danger of high voltage contact is present. Do not attach leads to high voltage conductors.** The equipment is not designed to provide high voltage protection and isolation.
- **Locating equipment uses electromagnetic fields that can be distorted and interfered with. More than one utility may be present in a given area.** Follow local guidelines and one call/call before you dig service procedures. Exposing a utility is the only way to verify its existence, location and depth.
- **Avoid traffic. Pay close attention to moving vehicles when using on or near roadways.** Wear visible clothing or reflector vests.
- **Before operating the RIDGID A-Frame Fault Locator, read and understand this operator's manual and the instructions for any other equipment used.** Failure to follow all instructions and warnings may result in property damage and/or serious injury.

- Use this manual in conjunction with all company, utility or facility procedures and policies. Familiarize yourself with all required procedures and policies, including safety practices, prior to entering an area and using the equipment.

NOTICE Ridge Tool Company, its affiliates and suppliers, will not be liable for any injury or any direct, indirect, incidental or consequential damages sustained or incurred by reason of the use of the A-Frame Fault Locator.

RIDGID Contact Information

If you have any question concerning this RIDGID® product:

- Contact your local RIDGID distributor.
(800)

Description

The RIDGID® A-Frame Fault Locator is a highly sensitive transmitter and receiver specifically designed to detect the location of a path to ground fault (Direct Fault Finding (DFF)) in the insulation of a buried conductor (such as a wire or cable). Damaged insulation, severed conductor, and other faults with ground leakage are easily and precisely located.

Model FT-103 Transmitter connects to the insulated conductor and establishes a current flow, the current leaks to ground through the insulation fault and back to the ground stake. Model FR-30 Receiver detects the current flow to ground through the insulation fault. The receiver provides audio and visual indications of both signal strength and direction to assist in detecting and locating the fault. For the A-Frame fault detector to work, the conductor must be in contact with the earth – it will not work with conductors in conduit.

Additionally, the transmitter can be used to apply a signal to the conductor for path locating with other receivers, such as RIDGID SeekTech® or NaviTrack® Locators. This can be done by direct connect and inductive methods. Multiple frequencies and power levels are provided.

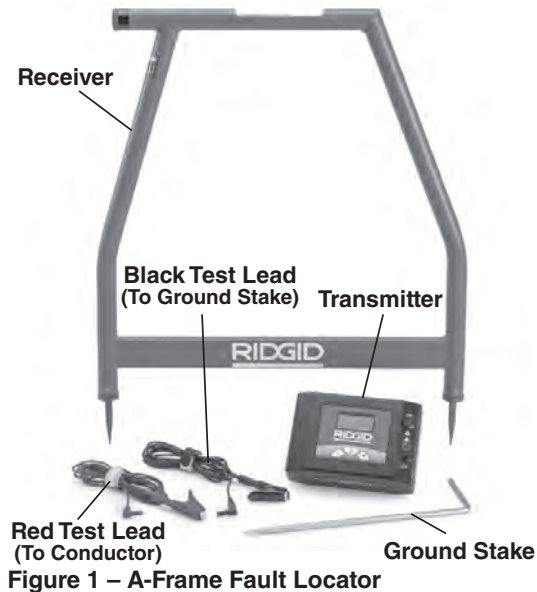

Transmitter

Transmitter Controls:

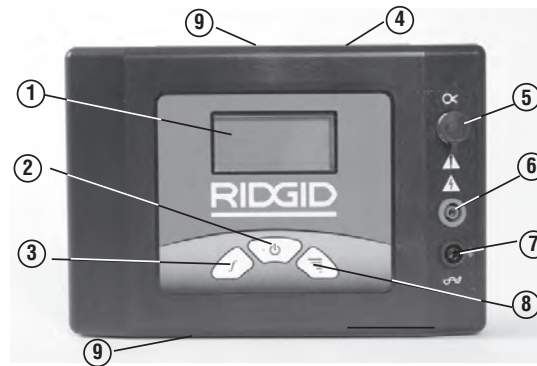

#	Icon	Description
1.	—	LCD Screen
2.		ON/OFF and Inductive Mode Switch Main Power Switch – Short press turns unit ON/OFF Long press (5 seconds) enables Broadcast Inductive mode.
3.		Frequency Selection Selects the frequency of transmitter from preloaded frequencies. See <i>Specifications</i> for frequencies
4.	—	Serial and Warning Label (back of unit)
5.		Inductive Clamp Jack
6.	—	Positive Terminal (to Conductor)
7.		Negative Terminal (to Ground Stake)
8.		Signal Power Setting Depressing the Signal Power Button cycles the Signal Power between Low, Medium and High
9.	—	Broadcast Inductive Decal (top and bottom)

Figure 2 – Transmitter Controls

Transmitter Display:

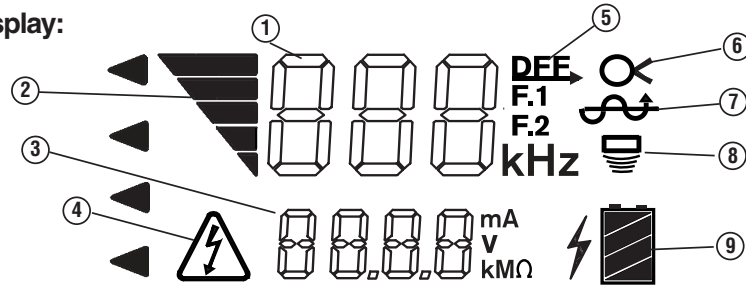

Number	Icons	Description
1	--- kHz	Frequency. "dFF" shown for fault finding.
2	▴	Signal Power - # Of Bars On Increases with Increasing Power. Three Levels – Low, Medium and High.
3	---	Circuit Information, mA, V or Resistance in Ohms. Transmitter cycles through each at 2 second intervals.
4	⚡	Voltage Warning – Transmitter connected to energized conductor – risk of electrical shock. Do not touch transmitter, leads or connections. Use high voltage precautions to disconnect.
5	dFF	Transmitter Set for Fault Finding (dFF displayed in Frequency area (1)).
6	⊗	Transmitter Set for Inductive Clamp Use for Path Locating (Insert Inductive clamp into Jack)
7	⊕	Transmitter Set for Direct Connect Use for Fault Finding or Path Locating.
8	⊙	Transmitter Set for Broadcast Inductive Mode for Path Locating.
9	🔋	Transmitter Battery Status.

Figure 3 – Transmitter Display

Receiver

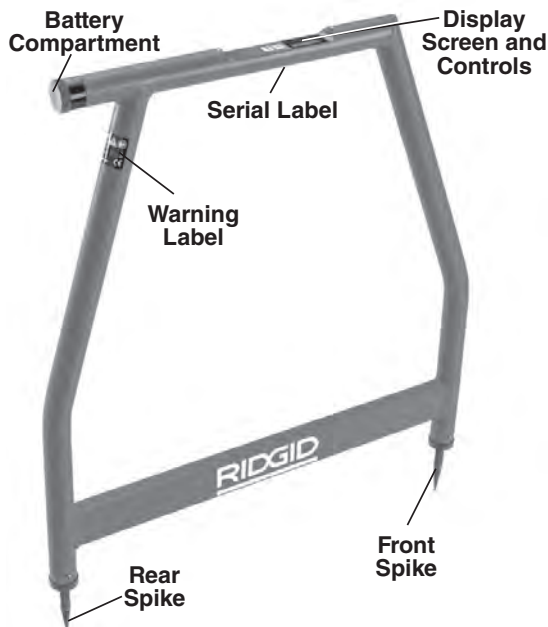
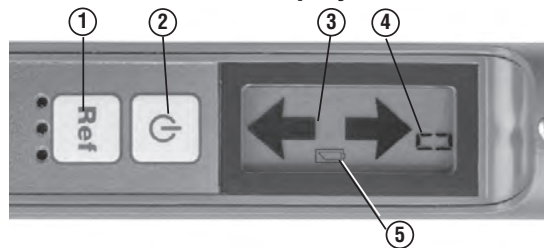

Figure 4 – A Frame Receiver

Receiver Controls/Display:



#	Icon	Description
1	Ref	Reference Button Stores and displays starting signal strength when pressed.
2	⏻	ON/OFF Button Main Power Switch – Press to turn unit ON/OFF
3	↔	Directional Arrow Indicates direction of fault
4	--	Signal Strength Displays absolute signal Strength from 0 to 99.
5	🔋	Low Battery Indicator

Figure 5 – Receiver Controls

Specifications

FT-103 Transmitter:

Operating FrequenciesDirect Fault Finding:
797 Hz - "dFF" displayed

Path locating:
128 Hz, 1 kHz, 8 kHz, 33 kHz, 93 kHz

Direct Connect:
128 Hz, 1 kHz, 8 kHz, 33 kHz, 93 kHz

Inductive Clamp:
8 kHz, 33 kHz, 93 kHz

Broadcast Inductive:
33 kHz, 93 kHz

Load Range5 Ω to 2M Ω

Output PowerUp to 3 Watts (Low, medium and high settings)

Output Voltage ...5 Volts - 600 Volts

Power Supply8 × C (R14) Cell Batteries, 12 Volt

Battery LifeContinuous: up to 15 hours, Intermittent: up to 60 hours (on low at 1000 Ohm load)

Operating Temperature-4°F to 133°F (-20°C to 55°C)

Storage Temperature-13°F to 140°F (-25°C to 60°C)

IP RatingIP54

Size8.5" x 5.8" x 2.5" (21 cm x 15 cm x 6 cm)

Weight.....2.2 lbs. (1 kg)

Test Lead Jacks.....0.16" (4mm) as per IEC61010

FR-30 A-Frame Receiver:

Operating FrequenciesFault Finding: 797 Hz - "dFF" displayed
Direct Connect:

Fault Finding DepthUp to 20' (6m) (depending on conditions)

Fault Finding Length.....Up to 3 miles (4800 m) (depending on conditions)

DisplayBlack and White LCD

Audio IndicationPiezo Response

Power Supply6 × AA (LR6) Batteries, 9 Volt

Battery Life.....Continuous: up to 40 hours, Intermittent: up to 82 hours

Operating Temperature-4°F to 133°F (-20°C to 55°C)

Storage Temperature-13°F to 140°F (-25°C to 60°C)

IP RatingIP54

Size30.3" x 30.4" x 1.5" (77 cm x 77 cm x 4 cm)

Weight.....3 lbs. (1.3 kg)

Standard Equipment

The A-Frame Fault Locator package includes the following items:



- FR-30 A-Frame Receiver
- FT-103 Transmitter
- Ground Stake
- Red and Black Test Leads (7.5' (2.3 m) long)
- Carry Cases
- Batteries
- Operator's Manual Pack

NOTICE This equipment is used for conductor fault and path locating. Incorrect use or improper application may result in incorrect or inaccurate locating. Selection of appropriate locating methods for the conditions and proper operation is the responsibility of the user.

Changing/Installing Batteries

⚠ WARNING

Switch unit OFF and remove any connections from the Transmitter/Receiver before changing batteries.

The A-Frame Fault Locator is supplied without the batteries installed. Remove the batteries prior to storage to avoid battery leakage. When the low battery indicator appears on the transmitter () or receiver () display, the batteries need to be replaced.

NOTICE Use the batteries that are of same type. Do not mix battery types. Do not mix new and used batteries. Mixing batteries can cause overheating and battery damage.

Transmitter:

1. With device OFF, remove the battery compartment cover. If needed, remove batteries (Figure 6).

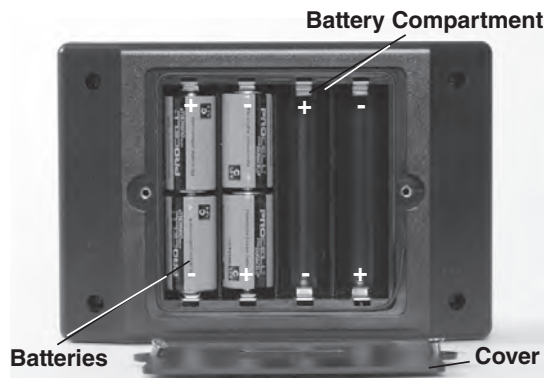

Figure 6 – Changing the Batteries (Transmitter)

2. Install eight new C Cell alkaline batteries (R14), observing correct polarity as indicated in the battery compartment.
3. Securely reinstall the battery compartment cover.

Receiver (A-Frame):

1. With device OFF, unscrew the battery compartment cover on the top tube (Figure 7). If needed, remove batteries.

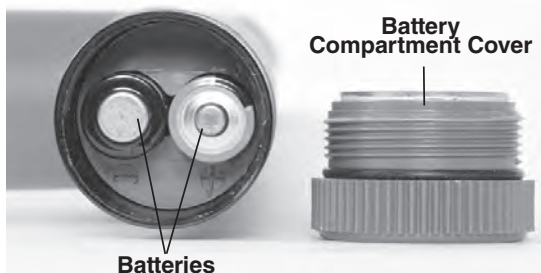

Figure 7 – Changing the Batteries (Receiver)

2. Install six new AA alkaline batteries (LR6), observing correct polarity as indicated in the battery compartment.
3. Securely reinstall the battery compartment cover.

Pre-Operation Inspection

⚠ WARNING



Daily before use, inspect your A-Frame

Fault Locator and correct any problems to reduce the risk of serious injury from electric shock and other causes, and prevent equipment damage.

1. Make sure the transmitter and receiver units are OFF.
 2. Remove the batteries and inspect for signs of damage. Replace if necessary. Do not use if the batteries are damaged.
 3. Clean the equipment. This aids inspection and helps prevent the tool from slipping from your grip.
 4. Inspect the locator for the following:
 - Proper assembly, maintenance and completeness.
 - Any broken, worn or missing parts.
 - Inspect the transmitter test leads for damaged insulation or exposed wire.
 - Presence and readability of the transmitter and receiver warning labels (Figure 2 and 4).
 - Any other condition which may prevent safe and normal operation.
- If any problems are found, do not use the A-Frame Fault Locator until the problems have been repaired.
5. Inspect and maintain any other equipment being used per its instructions to make sure it is functioning properly.

Set-Up And Operation Instructions

⚠ WARNING

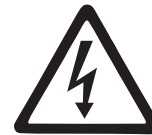

Do not connect to live voltage or active utility lines. Disconnect the conductor to be tested from any other service, components, or anything that might be affected by high voltage. De-energize any circuits in or around the work area.

Always attach transmitter test leads before turning unit ON and turn unit OFF before disconnecting leads. This will reduce the risk of electrical shock.

Never turn transmitter ON the unit when anyone is touching the conductor, ground stake, or any part of the transmitter. Turn

OFF transmitter before touching test lead or any un-insulated conductor.

Do not use where a danger of high voltage contact is present. Do not attach leads to high voltage conductors. The equipment is not designed to provide high voltage protection and isolation.

Locating equipment uses electromagnetic fields that can be distorted and interfered with. More than one utility may be present in a given area. Follow local guidelines and one call/call before you dig service procedures. Exposing a utility is the only way to verify its existence, location and depth.

Follow set up and operating instructions to reduce the risk of injury from electrical shock and other causes and to prevent tool damage

Model FT-103 Transmitter and Model FR-30 Receiver are used for fault locating of conductors through direct connect method.

The Model FT-103 Transmitter only can be used for path locating with RIDGID SeekTech® and NaviTrack® Locators. This can be done by direct connect and inductive methods.

1. Confirm have appropriate work area (See *General Safety Rules*). Operate in clear, level, stable, dry location. Do not use transmitter while standing in water.
2. Determine the correct equipment for the application, see *Description* and *Specifications* sections.
3. Make sure all equipment has been inspected and set up as directed in their instructions.

Fault Locating

It is good practice to locate the conductor path before attempting to fault locate. This can be done using a variety of RIDGID locating equipment. If during the location of the conductor path an unusual amount of signal loss occurs, this may give some indication of the conductor insulation fault location. Additionally, use visual cues and past history to aid in identifying the conductor path and potential fault locations.

Once the conductor path is determined, the RIDGID FT-103 Transmitter and FR-30 A-Frame Receiver can be used to locate ground faults in the insulated conductor. The Model FT-103 Transmitter connects to the insulated conductor and establishes a current flow, the current leaks to ground through the insulation fault

and back to the ground stake. The Model FR-30 Receiver detects the current flow to ground through the insulation fault. For the A-Frame fault detector to work, the conductor must be in contact with the earth – it will not work with conductors in conduit. Generally, the A-Frame Fault Locator works best in earth. Use with gravel, asphalt, concrete or other ground covers may not work as well.

The signal strength at the fault depends on the amount of current leaking there. The greater the leakage, the greater the signal strength.

Connecting Transmitter

1. Disconnect all loads and grounds from the conductor to be tested and all neighboring conductors to prevent damage from high voltage and false reading. Both ends should be known and disconnected. Disconnecting both ends of the conductor forces all of the transmitter signal through the fault, improving the fault locate.

2. Insert supplied ground stake into the earth. Ideally, the ground stake should be in line with the conductor, 3' to 6' (1m to 2m) from the end. If conditions require, the ground stake can be placed to the side of the conductor. Do not to place the ground stake over the conductor. It is not recommended to use other existing grounds, existing grounds may result in signal being inadvertently applied to non-target cables.

A good ground results in a stronger tracing signal. To get a good ground, insert the ground stake as far as possible into the earth. Moist earth will give a better ground than dry earth. Wetting the earth around the ground stake can improve grounding. This lowers the resistance of the circuit. While moist earth around the ground stake improves the circuit, do not use the transmitter in areas that are wet, this can increase the risk of electrical shock.

3. Make sure that the transmitter is OFF.
4. Connect BLACK test lead to the ground stake. Always connect to the ground stake first.
5. Connect the BLACK and RED test leads to the Transmitter.
6. Connect the RED test lead to the conductor to be tested (see *Figure 9*).

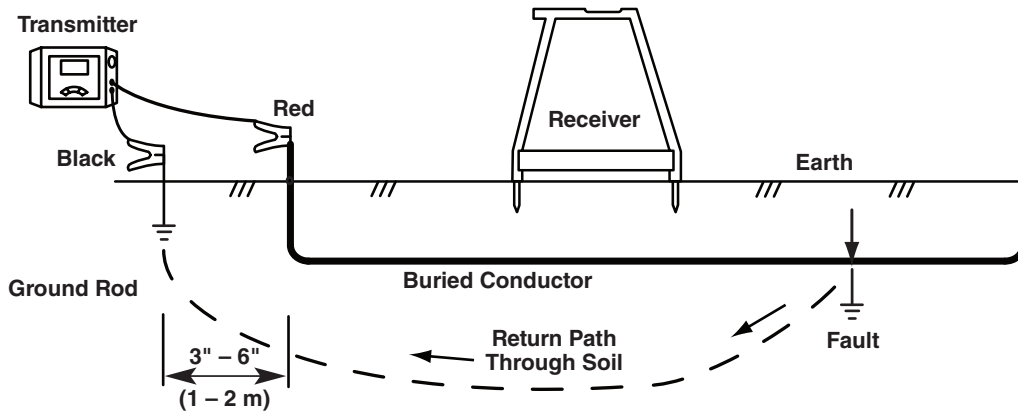

Figure 8 – Transmitter Connections for Fault Locating

Locating

1. Make sure that no one is near or touching the conductor, transmitter, leads or ground stake. Press the ON/OFF button on the transmitter to turn the transmitter ON. When the transmitter is turned on, it is set to the last used frequency. If needed, press the frequency button on the transmitter until “dFF” is shown on screen (Figure 9).



Figure 9 – Transmitter Screen

Adjust the signal power by pressing the signal power button to cycle through the settings (low, medium and high). Using high power may result in signal going to ground at non-target points, low power may mean a circuit is not created. The transmitter will display circuit resistance (OHMS) at the bottom of the LCD. The lower the resistance the better the locate signal. To improve the circuit, improve the ground, check the lead connections or increase the power.

The transmitter will continuously beep when there is a circuit. The lower the circuit resistance, the quicker the beep. The transmitter will beep three times and a pause (repeating) if there is no circuit.

If the transmitter display shows voltage warning (Figure 3), the transmitter is connected to live voltage. If this happens, **DO NOT TOUCH**

THE TRANSMITTER, LEADS OR CONNECTIONS. The target conductor is energized and there is the risk of electrical shock. Use high voltage precautions to disconnect.

2. When fault locating, generally the receiver should be used over the conductor, with the front receiver spike towards the expected fault and the rear receiver spike towards the ground stake. The receiver spikes should evenly penetrate the earth to make good electrical contact. The current flowing in and out of the ground spikes supplies the signal to locate the insulation fault (see Figure 10).

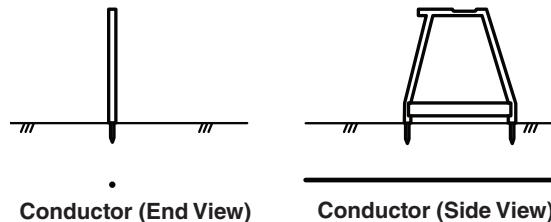

Conductor (End View) Conductor (Side View)
Figure 10 – Receiver Positioning

3. To start the locate, place the A-Frame receiver between the ground stake and the transmitter connection to the conductor. Press the A-Frame Receiver ON/OFF button to turn receiver ON.

The signal strength will appear on the receiver display. Signal strength will be the highest near the ground stake and at faults. Press the “Ref” button to store a reference signal strength near the ground stake.

The receiver display arrows will indicate the direction of the fault. Fault direction is also indicated audibly - a long slow beep indicates forward direction and a quick beep indicates backward direction.

- Remove the receiver from the earth and move several steps as indicated by the directional arrow and beeping along the conductor path. Reinsert the receiver spikes into the earth (*Figure 11*).

Continue moving away from the ground stake along the conductor path. Signal strength should drop (in some cases going to zero) and then rise as you move towards a fault.

- Signal strength will peak over the fault. If you pass the fault, the directional arrow will change direction and the beep will change from long slow to quick beep and the signal strength will decrease. Continue to move the receiver back and forth until slight movement causes the directional arrows and beeping to toggle back and forth. At this point, the fault is centered between the spikes of the receiver.

Compare the signal strength to the reference signal strength taken near the ground stake. They should be similar. If the fault signal strength is much lower than the reference value, you may not have located a fault. For instance, a grounded splice point would behave as a fault during the locate, but would give a much lower signal strength. For a low fault signal strength, you may want to mark the location and continue down the conductor

path looking for a fault signal strength closer to the reference signal.

Once a fault is located with a signal similar to the reference signal, turn the A-Frame Locator perpendicular to the path of the conductor. Move the receiver back and forth until slight movement causes the directional arrows and beeping to toggle back and forth. At this point, the fault is centered between the spikes of the receiver. See *Figure 12*. Mark the location of the fault.

- Once the locating is completed, press the ON/OFF button to turn the transmitter OFF. Always turn the unit OFF before disconnecting the cable leads to reduce the risk of electrical shock. Remove the cable lead from the target conductor first. Always disconnect the cable lead from the target conductor first before removing the cable lead from the ground spike to reduce the risk of electrical shock. Disconnect the cable lead from the ground spike.

Locating Below Paved Surfaces

Locating can be difficult if the fault is below a paved surface, because the receiver spikes cannot make good electrical contact with the earth. In this case, there are several methods that can be used.

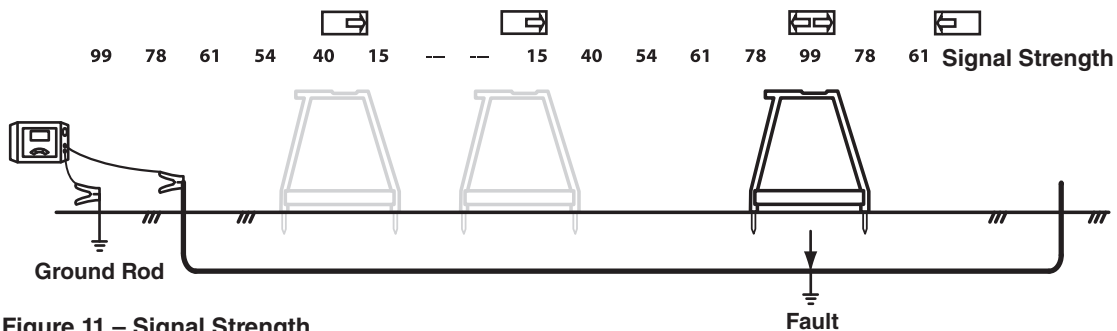

Figure 11 – Signal Strength

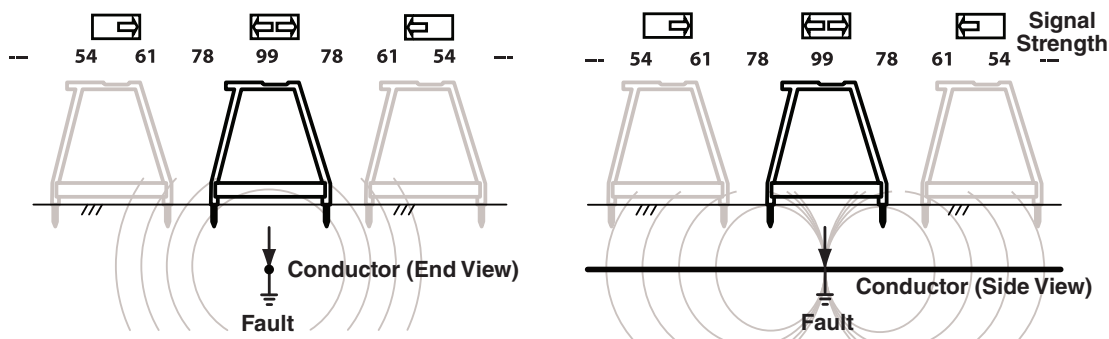

Figure 12 – Final Locate

- If the paved area is relatively small, the receiver can be used around the periphery of the area. The receiver can be rotated side to side, and where the receiver directional arrows and beeping toggle back and forth, extend a straight line perpendicular to the center of the A-Frame Receiver. Do this in several locations around the suspected fault area. The straight lines should all intersect at the same point. This is the location of the fault. This method of locating is less exact than placing the receiver directly over the conductor. See *Figure 13*.
- An alternate way to locate below paved surfaces is to improve the conductivity between the pavement and the receiver with water. One method is to attach sponges to the spikes of the receiver. Wet the sponges with water and keep wet. Conduct the fault locate normally.
- Another method is to wet the surface of the pavement with water and conduct the fault locate normally. Do not do this in the area of the transmitter – this increases the risk of electrical shock.

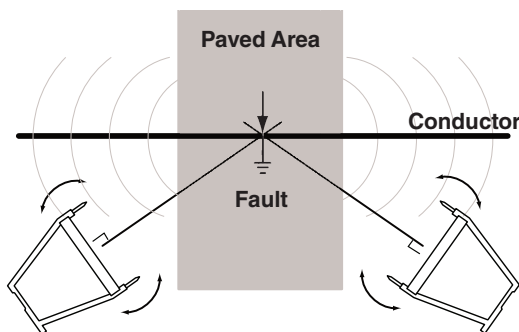

Figure 13 – Locating below paved surfaces

Multiple Faults

If there are multiple faults in the conductor, the faults will have signals proportional to the amount of current leaking. The locate is done the same as for a single fault, but the signal strength will not be as strong. Typically, the largest fault (least resistance fault) is easiest to find. Best practice is to find and repair the first fault and continue the locate for other faults.

Path Locating

The FT-103 Transmitter can be used with other commercially available receivers (such as the RIDGID SeekTech or NaviTrack receivers) to path locate conductors. The FT-103 transmitter

can be used to apply an active tracing signal to a conductor in three ways:

- **Direct Connect** – The transmitter's leads are connected directly to the target conductor and a suitable ground. This method is most commonly used when the target utility is accessible. Direct connect should not be used for energized (live) conductors.
- **Inductive Clamp** (optional equipment) – the jaws of the inductive clamp encircle the target conductor; if the conductor is insulated, there is no metal to metal contact. This method is commonly used when the target utility is accessible but direct connect is not possible on an insulated cable.
- **Broadcast Inductive Mode** – The transmitter generates a field, which in turn induces a current in the target conductor. There is no direct connection between the transmitter and the target conductor. The transmitter is placed over and inline with the target conductor. The transmitter's internal antenna induces a signal onto the target conductor. This method is most commonly used when the target utility is not accessible.

Disconnect all loads from the conductor to be tested and all neighboring conductors to prevent damage from high voltage and false reading.

Direct Connect Path Locating Method

1. Insert supplied ground stake into the earth. Or, if other good grounds are available in the area, they can be used.

A good ground results in a stronger tracing signal. To get a good ground, insert the ground stake as far as possible into the earth. Moist earth will give a better ground than dry earth. Wetting the earth around the ground stake can improve grounding. This lowers the resistance of the circuit. While moist earth around the ground stake improves the circuit, do not use the transmitter in areas that are wet, this can increase the risk of electrical shock.

The far end of the conductor should be grounded.

2. Make sure that the transmitter is OFF.
3. Connect BLACK test lead to the ground stake. Always connect to the ground stake first.
4. Connect the BLACK and RED test leads to the Transmitter.

5. Connect the RED test lead to the conductor to be tested.
6. Press the ON/OFF button to turn the transmitter ON. When the transmitter is turned on, it is set to the last used frequency. Press the frequency selection button to cycle through frequency settings to the desired locating frequency.

Adjust the signal power by pressing the signal power button to cycle through the settings (low, medium and high). Using high power can couple into non-target conductors, low power may mean a circuit is not created. The transmitter will display circuit resistance (OHMS) at the bottom of the LCD. The lower the resistance the better the locate signal. To improve the circuit, improve the ground, check the lead connections, increase power or change the frequency.

If the transmitter display shows voltage warning (*Figure 3*), the transmitter is connected to live voltage. If this happens, **DO NOT TOUCH THE TRANSMITTER, LEADS OR CONNECTIONS.** The target conductor is energized and there is the risk of electrical shock. Use high voltage precautions to disconnect.

7. Check the circuit and adjust signal power, grounding or connections to ensure locatable field.
8. Turn ON the receiver/locator and follow the instructions for the receiver. Make sure the receiver's frequency is set to match that on the transmitter. Confirm the receiver is picking up the transmitted frequency by holding it near the transmitter and observing the increase in receiver signal.
9. Once the locating is completed, press the ON/OFF button to turn the transmitter OFF. Always turn the unit OFF before disconnecting the cable leads to reduce the risk of electrical shock. Remove the cable lead from the target conductor first. Always disconnect the cable lead from the target conductor first before removing the cable lead from the ground spike to reduce the risk of electrical shock. Disconnect the cable lead from the ground spike.

Inductive Clamp Path Locating

1. This method requires an inductive clamp (*Optional equipment*). Read and follow

all instruction for the use of the inductive clamp.

2. Insert the plug of the inductive clamp into transmitter (*see Figure 2*).
3. Clamp the jaws of the inductive clamp around the target conductor. Make sure that the jaws of the clamp are fully closed. (*See Figure 14*). Both ends of the conductor should be grounded for best results.



Figure 14 – Inductive Clamp Attached to a Conductor

4. Press the ON/OFF button to turn the transmitter ON. When the clamp is plugged in the clamp symbol (⊗) shows on the screen and only clamp frequencies are available. Press the frequency selection button to cycle through frequency settings to the desired locating frequency. Adjust the signal power by pressing the signal power button to cycle through the settings (low, medium and high). The inductive clamp typically works best with frequencies around 8kHz, 33 kHz, 93kHz.
5. Check the circuit and adjust signal strength (*see Figure 3, Circuit Information*).
6. Turn ON the receiver/locator and follow the instructions for the receiver. Make sure the receiver's frequency is set to match that on the transmitter. Confirm the receiver is picking up the transmitted frequency by holding it near the transmitter and observing the increase in receiver signal.
7. Once the locating is completed, press the ON/OFF button to turn the transmitter OFF.

Broadcast Inductive Path Locating

1. Properly place the transmitter relative to the target conductor (*see Figure 15*). On the top of the transmitter is an arrow. Set

transmitter on ground, align arrow with the target conductor.

- Press the ON/OFF button to turn the transmitter ON. Press and hold the power button for 5 seconds selection button to shift transmitter into broadcast inductive mode. Broadcast inductive icon () appears on screen and the transmitter will start beeping to indicate that it is operating.

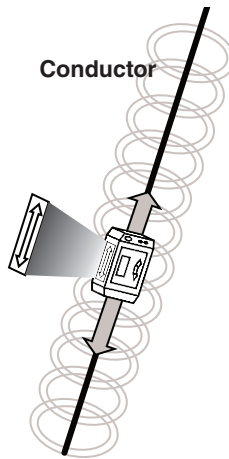

Figure 15 – Orientation to the Line – Inductive Mode

Adjust the signal power by pressing the signal power button to cycle through the settings (low, medium and high) and choose high. Press the frequency selection button to cycle through 33khz and 93kHz frequency settings to the desired locating frequency. When using Broadcast Inductive Mode, higher frequencies tend to get a better signal at the receiver.

- Turn ON the locator and follow its instructions. Make sure to set the receiver to the same frequency as the transmitter.

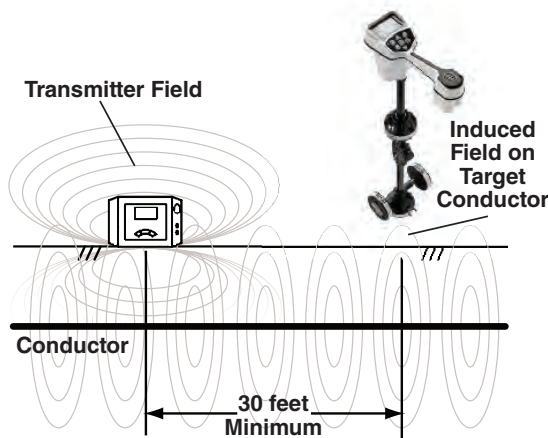

Figure 16 – Orientation to the Line – Inductive Mode

When the transmitter is in broadcast inductive mode, it generates a field around the transmitter. This field is in both the ground (towards the target conductor) and into the air around the transmitter. When the receiver is within approximately 30 feet (10 meters) of the transmitter, it will measure the field directly from the transmitter and not the signal induced on the target con-

ductor. This is called “Air Coupling.” Operate the receiver at least 30 feet from the transmitter to prevent this. (See Figure 16).

One way to confirm that you are tracing the target conductor and not the transmitter field is to look for a strong, stable proximity signal and a valid depth measurement on the receiver. While directly over the energized line you can also raise the receiver a set distance off of the ground, and verify that the depth reading on the display equals the distance that you raised the receiver.

- Once the locating is completed, press the Power ON/OFF button for 5 seconds to exit broadcast inductive mode, then press the ON/OFF button to turn the transmitter OFF.

Storage

Remove batteries from tool. Store the A-Frame Fault Locator in case. Avoid storing in extreme heat or cold.

⚠ WARNING Store tool in a dry, secured area that is out of reach of children and people unfamiliar with the RIDGID A-Frame Fault Locator. The locator is dangerous in the hands of untrained users.

Maintenance

⚠ WARNING

Remove batteries from tool before performing maintenance or making any adjustment.

Cleaning

Do not immerse the A-Frame Fault Locator in water. Wipe off dirt with a damp soft cloth. Avoid rubbing too hard. Do not use aggressive cleaning agents or solutions.

Calibration

The A-Frame Fault Locator is factory calibrated and only requires recalibration if repaired.

Service And Repair

⚠ WARNING

Improper service or repair can make the machine unsafe to operate.

Service and repair on this A-Frame Fault Lo-

locator must be performed by a RIDGID Independent Service Center. Use only RIDGID service parts.

For information on your nearest RIDGID Independent Service Center or any service or repair questions, see *Contact Information Section* in this manual.

Optional Equipment

⚠ WARNING

To reduce the risk of injury, only use accessories specifically designed and recommended for use with the RIDGID A-Frame Fault Locator, such as listed below.

Catalog No.	Description
20973	RIDGID SeekTech 4" (100 mm) Inductive Signal Clamp
57763	Ground Stake, FT-103
57768	Red and Black Test Leads, FT-103
96967	RIDGID NaviTrack II Locator
19238	RIDGID NaviTrack Scout Locator
22163	RIDGID SeekTech SR-60 Line Locator
21893	RIDGID SeekTech SR-20 Line Locator
44473	RIDGID SR-24 Line Locator with Bluetooth® and GPS

Disposal

Parts of this tool contain valuable materials and can be recycled. There are companies that specialize in recycling that may be found locally. Dispose of the components in compliance with all applicable regulations. Contact your local waste management authority for more information.



For EC Countries: Do not dispose of electrical equipment with household waste!

According to the European Guideline 2012/19/EU for Waste Electrical and Electronic Equipment and its implementation into national legislation, electrical equipment that is no longer usable must be collected separately and disposed of in an environmentally correct manner.

Battery Disposal

For EC countries: Batteries must be recycled according to the guideline 2006/66/EEC.

EC Declaration of Conformity

The EC Declaration of Conformity (890-011-320.10) will accompany this manual as a separate booklet when required.

FCC Statement

This equipment has been found to comply with the limits for a Class B digital device, pursuant to part 15 of the FCC Rules. These limits are designed to provide reasonable protection against harmful interference in a residential installation.

This equipment generates, uses, and can radiate radio frequency energy and, if not installed and used in accordance with the instructions, may cause harmful interference to radio communications.

However, there is no guarantee that interference will not occur in a particular installation.

If this equipment does cause harmful interference to radio or television reception, which can be determined by turning the equipment OFF and ON, the user is encouraged to try to correct the interference by one or more of the following measures:

- Reorient or relocate the receiving antenna.
- Increase the separation between the equipment and receiver.
- Consult the dealer or an experienced radio/TV technician for help.

Electromagnetic Compatibility (EMC)

The term electromagnetic compatibility is taken to mean the capability of the product to function smoothly in an environment where electromagnetic radiation and electrostatic discharges are present and without causing electromagnetic interference to other equipment.

NOTICE The RIDGID A-Frame Fault Locator conform to all applicable EMC standards. However, the possibility of it causing interference in other devices cannot be precluded. All EMC related standards that have been tested are called out in the tool's technical document.

What is covered

RIDGID® tools are warranted to be free of defects in workmanship and material.

How long coverage lasts

This warranty lasts for the lifetime of the RIDGID® tool. Warranty coverage ends when the product becomes unusable for reasons other than defects in workmanship or material.

How you can get service

To obtain the benefit of this warranty, deliver via prepaid transportation the complete product to RIDGE TOOL COMPANY, Elyria, Ohio, or any authorized RIDGID® INDEPENDENT SERVICE CENTER. Pipe wrenches and other hand tools should be returned to the place of purchase.

What we will do to correct problems

Warranted products will be repaired or replaced, at RIDGE TOOL'S option, and returned at no charge; or, if after three attempts to repair or replace during the warranty period the product is still defective, you can elect to receive a full refund of your purchase price.

What is not covered

Failures due to misuse, abuse or normal wear and tear are not covered by this warranty. RIDGE TOOL shall not be responsible for any incidental or consequential damages.

How local law relates to the warranty

Some states do not allow the exclusion or limitation of incidental or consequential damages, so the above limitation or exclusion may not apply to you. This warranty gives you specific rights, and you may also have other rights, which vary, from state to state, province to province, or country to country.

No other express warranty applies

This FULL LIFETIME WARRANTY is the sole and exclusive warranty for RIDGID® products. No employee, agent, dealer, or other person is authorized to alter this warranty or make any other warranty on behalf of the RIDGE TOOL COMPANY.



Full lifetime warranty (garantie légale étendue à la durée de vie du produit, voir conditions de garantie / legal warranty extended to the product lifecycle, see warranty conditions)

Ridge Tool Company

Ce qui est couvert

Les outils RIDGID® sont garantis contre tous vices de matériaux et de main d'oeuvre.

Durée de couverture

Cette garantie est applicable durant la vie entière de l'outil RIDGID®. La couverture cesse dès lors que le produit devient inutilisable pour raisons autres que des vices de matériaux ou de main d'oeuvre.

Pour invoquer la garantie

Pour toutes réparations au titre de la garantie, il convient d'expédier le produit complet en port payé à la RIDGE TOOL COMPANY, Elyria, Ohio, ou bien le remettre à un réparateur RIDGID® agréé. Les clés à pipe et autres outils à main doivent être ramenés au lieu d'achat.

Ce que nous ferons pour résoudre le problème

Les produits sous garantie seront à la discrétion de RIDGE TOOL, soit réparés ou remplacés, puis réexpédiés gratuitement ; ou si, après trois tentatives de réparation ou de remplacement durant la période de validité de la garantie le produit s'avère toujours défectueux, vous aurez l'option de demander le remboursement intégral de son prix d'achat.

Ce qui n'est pas couvert

Les défaillances dues au mauvais emploi, à l'abus ou à l'usure normale ne sont pas couvertes par cette garantie. RIDGE TOOL ne sera tenue responsable d'aucuns dommages directs ou indirects.

L'influence de la législation locale sur la garantie

Puisque certaines législations locales interdisent l'exclusion des dommages directs ou indirects, il se peut que la limitation ou exclusion ci-dessus ne vous soit pas applicable. Cette garantie vous donne des droits spécifiques qui peuvent être éventuellement complétés par d'autres droits prévus par votre législation locale.

Il n'existe aucune autre garantie expresse

Cette GARANTIE PERPETUELLE INTEGRALE est la seule et unique garantie couvrant les produits RIDGID®. Aucun employé, agent, distributeur ou tiers n'est autorisé à modifier cette garantie ou à offrir une garantie supplémentaire au nom de la RIDGE TOOL COMPANY.

Qué cubre

Las herramientas RIDGID® están garantizadas contra defectos de la mano de obra y de los materiales empleados en su fabricación.

Duración de la cobertura

Esta garantía cubre a la herramienta RIDGID® durante toda su vida útil. La cobertura de la garantía caduca cuando el producto se torna inservible por razones distintas a las de defectos en la mano de obra o en los materiales.

Cómo obtener servicio

Para obtener los beneficios de esta garantía, envíe mediante porte pagado, la totalidad del producto a RIDGE TOOL COMPANY, en Elyria, Ohio, o a cualquier Servicentro Independiente RIDGID. Las llaves para tubos y demás herramientas de mano deben devolverse a la tienda donde se adquirieron.

Lo que hacemos para corregir el problema

El producto bajo garantía será reparado o reemplazado por otro, a discreción de RIDGE TOOL, y devuelto sin costo; o, si aún resulta defectuoso después de haber sido reparado o sustituido tres veces durante el período de su garantía, Ud. puede optar por recibir un reembolso por el valor total de su compra.

Lo que no está cubierto

Esta garantía no cubre fallas debido al mal uso, abuso o desgaste normal. RIDGE TOOL no se hace responsable de daño incidental o consiguiente alguno.

Relación entre la garantía y las leyes locales

Algunos estados de los EE.UU. no permiten la exclusión o restricción referente a daños incidentales o consiguientes. Por lo tanto, puede que la limitación o restricción mencionada anteriormente no rija para Ud. Esta garantía le otorga derechos específicos, y puede que, además, Ud tenga otros derechos, los cuales varían de estado a estado, provincia a provincia o país a país.

No rige ninguna otra garantía expresa

Esta GARANTIA VITALICIA es la única y exclusiva garantía para los productos RIDGID®. Ningún empleado, agente, distribuidor u otra persona está autorizado para modificar esta garantía u ofrecer cualquier otra garantía en nombre de RIDGE TOOL COMPANY.

Printed 3/17
EC42552

©2017, RIDGID, Inc.
The Emerson logo and RIDGID logo are registered trademarks of Emerson Electric Co. or RIDGID, Inc. in the U.S. and other countries.
All other trademarks belong to their respective holders.

999-995-095.10
REV. A

RIDGID

EMERSON

1.800.561.8187

www.itm.com

information@itm.com