

FLIR Vue Pro and Vue Pro R User Guide

Official Publication Date: July 2016

Official Expiration Date: Until next release



Vue Pro and Vue Pro R User Guide

Document Number: 436-0013-10

Version 110

436-0013-10, Rev. 110 Vue Pro and Vue Pro R User Guide
Information on this page is subject to change without notice



The World's **Sixth Sense™**

FLIR Vue Pro and Vue Pro R User Guide

Table of Contents

1 INTRODUCTION	4
1.1 SCOPE	4
1.2 REVISION HISTORY	4
2 RESOURCES	5
2.1 FLIR WEBSITE / TECH SUPPORT INFORMATION	5
2.2 FLIR SYSTEMS DOCUMENTS	5
2.3 EXTERNAL DOCUMENTS	5
2.4 ABBREVIATIONS / ACRONYMS	6
3 WHAT'S IN THE BOX	7
3.1 UNPACKING YOUR CAMERA	7
3.1.1 FLIR Vue Pro Camera with Camera Mount	7
3.1.2 Bench Cable	7
3.1.3 MicroSD Card	8
3.1.4 Accessory Cable	8
4 Connecting to the Camera	8
4.1 MECHANICAL INTERFACE	8
4.1.1 SIZE / WEIGHT	8
4.1.2 MOUNTING	9
4.2 ELECTRICAL INTERFACE	11
4.2.1 Bench Testing	11
4.2.2 COTS mini-USB Cables	11
4.2.3 FLIR Vue Pro Power & Video Adapter (HDMI Converter)	11
4.3 Software Interface	12
4.4 Connecting to a MAVLink Compatible Flight Controller	12
4.5 Camera Operation	13
5 The FLIR Vue Pro APP	14
5.1 Home Screen	14
5.1.1 Color Palette	15
5.1.2 Scene	16
5.1.3 Manual Controls	17
5.1.3.1 ROI	17
5.1.3.2 DDE	17
5.1.3.3 ACE	18
5.1.3.4 SSO	18
5.1.3.5 Save Custom Scene Presets	18
5.1.4 Zoom	18
5.1.5 Video/Still Image/Timelapse	18
5.1.5.1 Video	18
5.1.5.2 Still Images	19
5.1.5.3 Timelapse	19
5.1.6 Record	19
5.1.7 Recalibrate	19
5.1.8 Settings	20
5.1.8.1 Main	20
5.1.8.2 Accessory Port I/O	21
5.1.8.3 Radiometry	23

436-0013-10, Rev. 110 Vue Pro and Vue Pro R User Guide
Information on this page is subject to change without notice



The World's Sixth Sense™

FLIR Vue Pro and Vue Pro R User Guide

5.1.8.4 About.....	25
6 File Formats.....	27
6.1 JPEG.....	27
6.2 TIFF.....	27
6.3 Recommended Application Links.....	27
7 Care of FLIR Vue Pro.....	28
Appendix A - Software and Firmware Update.....	29
Appendix B - MAVLink Implementation.....	32

List of Figures

Figure 1. Vue Pro with Camera Mount.....	7
Figure 2. Bench Cable.....	8
Figure 3. Accessory Cable.....	8
Figure 4. ¼”-20 Mounting.....	9
Figure 5. Side and Bottom Mounting.....	9
Figure 6. Action Camera Interface.....	10
Figure 7. HDMI Converter (FLIR pn 4206334).....	11
Figure 8. PixHawk Flight Controller.....	12
Figure 9. Camera Status and Record LED Description.....	13
Figure 10. Home Screen.....	14
Figure 11. Color Palettes.....	15
Figure 12. Scene Presets.....	16
Figure 13. Manual Scene Controls.....	17
Figure 14. Main Settings.....	20
Figure 15. PWM Settings.....	21
Figure 16. Function Selection.....	21
Figure 17. Radiometry Tab.....	23
Figure 18. Spot Meter OSD.....	24
Figure 19. Scene Meter OSD.....	24
Figure 20. About Page.....	26
Figure 21. Upgrade Available.....	26
Figure 22. Firmware Upgrade.....	30
Figure 23. Upgrading and Bluetooth Disconnect Messages.....	30

List of Tables

Table 1. Accessory Cable Pinout Definition.....	12
Table 2. Image Formats Recorded on microSD Card.....	27

436-0013-10, Rev. 110 Vue Pro and Vue Pro R User Guide
Information on this page is subject to change without notice



The World's Sixth Sense™

www.itm.com

information@itm.com

FLIR Vue Pro and Vue Pro R User Guide

1 INTRODUCTION

1.1 SCOPE

Designed for professional use, FLIR's Vue Pro line of camera systems are more than a collection of thermal cameras. They are thermal measurement instruments and data recorders that add tremendous value to sUAS operations and services. While the Vue Pro R resembles the Vue Pro in physical appearance, it is a different product providing even more capabilities not possible with the original Vue Pro platform.

This guide shows how to get the plug-and-play FLIR Vue Pro and Vue Pro R cameras connected, running, and mounted. Unless specifically stated otherwise, all features and functions of the Vue Pro apply to the Vue Pro R. Radiometric functions are simply added to the Vue Pro to make the Vue Pro R. All references to Vue Pro contained in this guide are applicable to Vue Pro R, but not necessarily vice versa.

1.2 REVISION HISTORY

Version	Date	Comments
100	01/10/2014	Initial Release
110	06/22/2016	Updated content and to include Vue Pro R

FLIR Vue Pro and Vue Pro R User Guide

2 RESOURCES

Here is a sample of some of the resources that can be found:

2.2 FLIR SYSTEMS DOCUMENTS

Document Number	Document Title
n/a	Vue Pro Datasheet (Web Link)
n/a	Vue Pro R Datasheet (Web Link)
436-0013-19	FLIR Vue Pro Technical Drawing (Web Link)
n/a	FLIR Vue Pro STEP File (Download)
n/a	UAS Radiometry Tech Note (Web Link)
102-9012-01	Interface Requirements Specification for FLIR TIFF File Format (Web Link)

2.3 EXTERNAL DOCUMENTS

Document Number	Document Title
n/a	MAVLink Protocol (Web Link)

FLIR Vue Pro and Vue Pro R User Guide

2.4 ABBREVIATIONS / ACRONYMS

Abbreviation/ Acronym	Components
ACI	Action Camera Interface
AGC	Automatic Gain Control
DDE	Digital Detail Enhancement
ESD	Electrostatic Damage
FFC	Flat Field Correction
FOV	Field of View
GUI	Graphical User Interface
I/O	Input / Output
ICD	Interface Control Drawing / Document
IDD	Interface Description Drawing / Document
LUT	Look-Up Table
NTSC	National Television System Committee
OSD	On Screen Display
PAL	Phase Alternating Line
PWM	Pulse Width Modulation
RoHS	Reduction of Hazardous Substances
ROI	Region of Interest
TBD	To Be Determined
URL	Uniform Resource Locator

436-0013-10, Rev. 110 Vue Pro and Vue Pro R User Guide
Information on this page is subject to change without notice



The World's **Sixth Sense**™

www.itm.com

information@itm.com

FLIR Vue Pro and Vue Pro R User Guide

3 WHAT'S IN THE BOX

When unpacking the camera, please heed customary electrostatic-discharge (ESD) sensitive device precautions including static-safe work station and proper grounding. The camera is placed in a conductive anti-static bag to protect from ESD damage and safely packaged to prevent damage during shipping.

Disassembling the camera can cause permanent damage and will void the warranty. Operating the camera outside of the specified input voltage range or the specified operating temperature range can cause permanent damage. The camera back is not sealed. Avoid exposure to dust and moisture.

3.1 UNPACKING YOUR CAMERA

FLIR Vue Pro comes with the following components:

3.1.1 FLIR Vue Pro Camera with Camera Mount

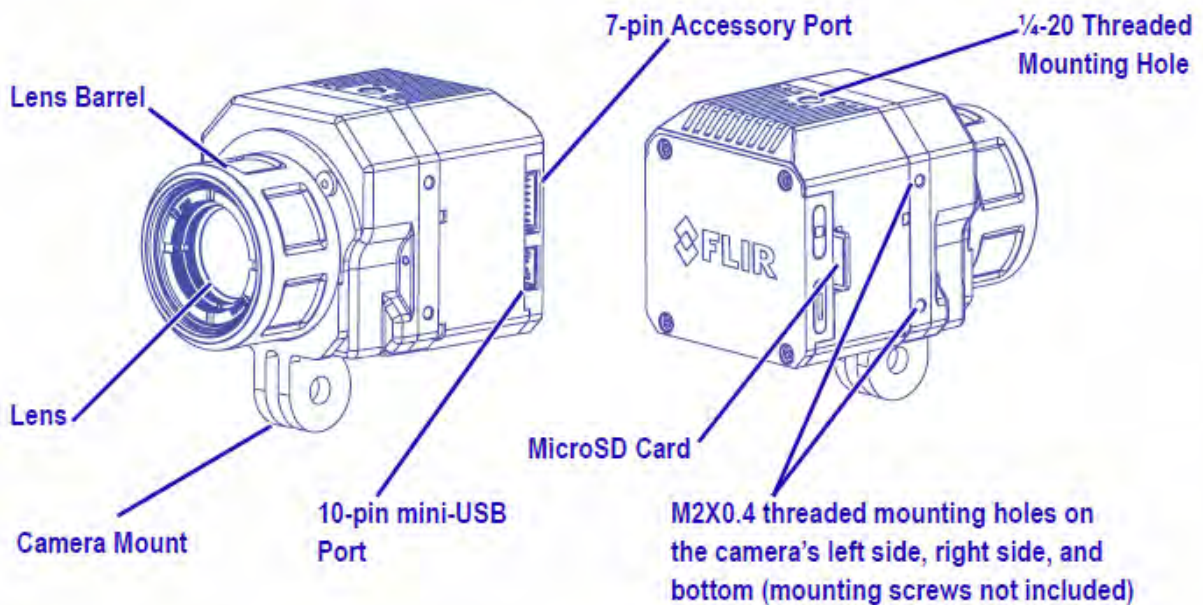

Figure 1. Vue Pro with Camera Mount

3.1.2 Bench Cable

The Bench Cable should be used for connecting the FLIR Vue Pro to a computer USB port for power and file transfer, as well as video output testing with an analog video monitor. Analog video output is accessed by connecting the RCA pigtail to a video display. Digital video is not accessible from the USB port.

FLIR Vue Pro and Vue Pro R User Guide

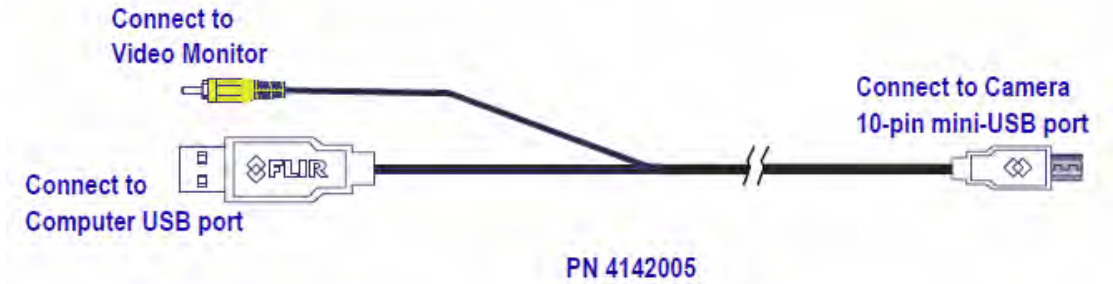

Figure 2. Bench Cable

3.1.3 microSD Card

The microSD card slot is for storing images/video and upgrading camera firmware. Maximum capacity is 32GB. A Class 6 or greater card should be used to achieve full camera performance.

3.1.4 Accessory Cable

The Accessory Cable is for connecting FLIR Vue Pro to a MAVLink compatible autopilot and/or standard R/C PWM outputs. **The MAVLink interface operates at a default data rate of 57.6 kbps.** See Table 1 for pin definitions and Section 5.1.8.2 for PWM signal profile.

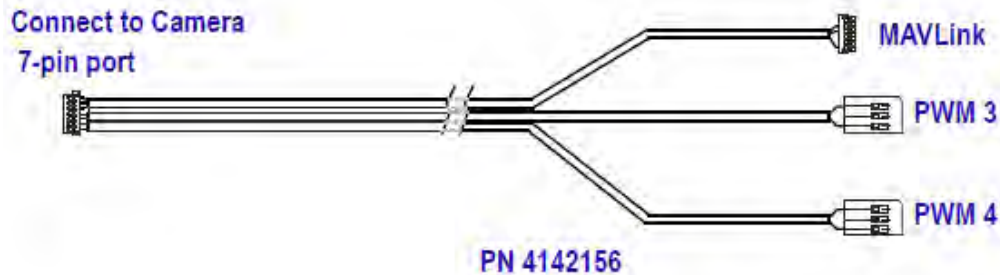

Figure 3. Accessory Cable

4 Connecting to the Camera

This section describes installation of necessary software, physical camera connections, and software connection to the camera.

4.1 MECHANICAL INTERFACE

4.1.1 SIZE / WEIGHT

The overall size of the Vue Pro is 44.45mm (h) x 44.45mm (w) x 62.6mm (d) (1.75 x 1.75 x 2.47 inches), including the lens but excluding cables. Weight is between 3.25 and 4 ounces, depending on lens configuration. These mechanical specs do not take into account any additional mounting hardware or cabling. For additional details, please see the Vue Pro Technical Drawing referenced in Section 2.2.

FLIR Vue Pro and Vue Pro R User Guide

4.1.2 MOUNTING

The Vue Pro camera provides precision mounting features on both sides, the top, and on the bottom surfaces of the housing. Perhaps the simplest approach to mounting the Vue Pro is to screw a standard tripod ($\frac{1}{4}$ "-20) mounting bolt into the threaded insert located on the top surface of the camera.

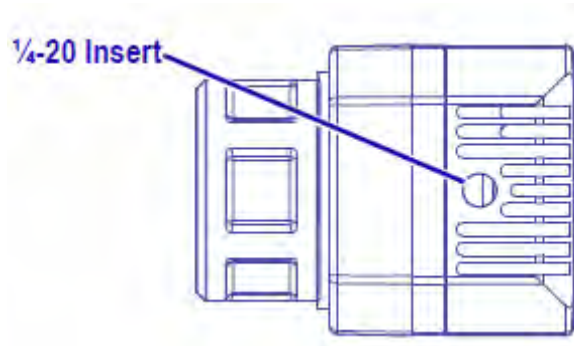

Figure 4. $\frac{1}{4}$ "-20 Mounting

Note: Do not exceed 6.35mm (0.25 in) maximum depth as internal damage could occur and warranty will be void.

The camera also has two threaded mounting holes on each side of the housing, as well as on the bottom. These threaded holes, 24mm (0.945 in) apart accept M2x0.4 screws (not included). Refer to the Vue Pro Technical Drawing for additional information.

Note: Do not exceed 4.0mm (0.157 in) maximum depth as internal damage could occur and warranty will be void.

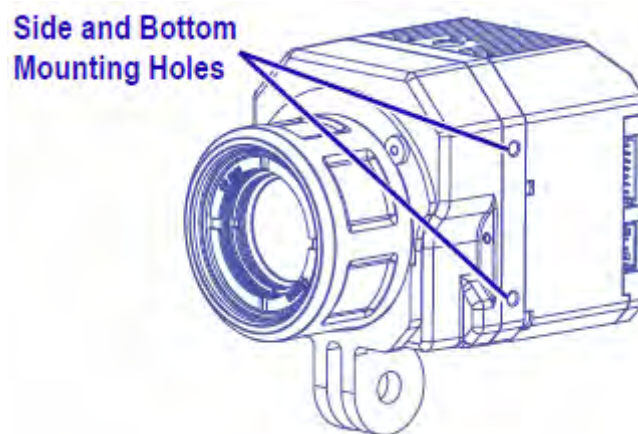

Figure 5. Side and Bottom Mounting

436-0013-10, Rev. 110 Vue Pro and Vue Pro R User Guide
Information on this page is subject to change without notice



The World's **Sixth Sense**[™]

www.itm.com

information@itm.com

FLIR Vue Pro and Vue Pro R User Guide

The included Action Camera Interface (ACI) allows using standard action camera mounts. If a different mounting option is to be used, the ACI can be removed using the following steps:

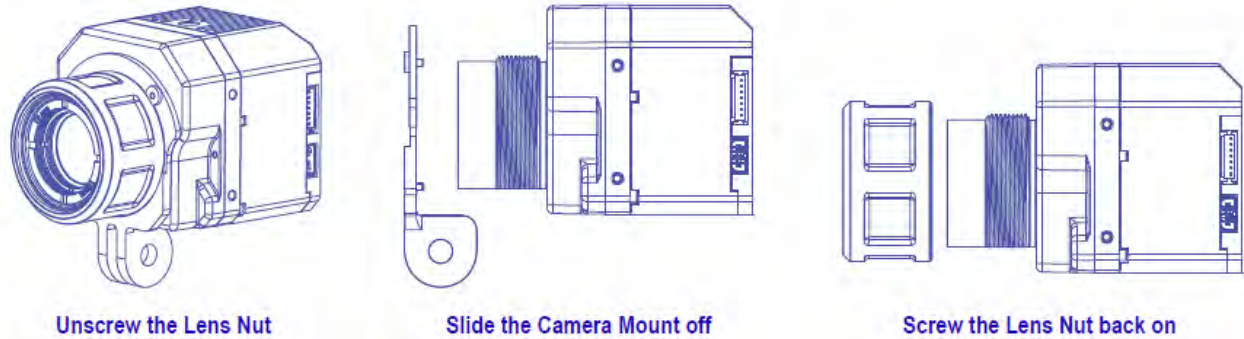

Figure 6. Action Camera Interface

When installing the ACI, be sure to engage the two alignment pins with the corresponding holes on the camera body. Refer to the Vue Pro Technical Drawing for additional information.

Note: Use of retaining compound such as VIBRA-TITE VC-3 is recommended. Due to the large diameter of the thread, very little is required to inhibit nut back off.

FLIR Vue Pro and Vue Pro R User Guide

4.2 ELECTRICAL INTERFACE

4.2.1 Bench Testing

For initial bench testing, connect the 10-pin mini-USB connector on the Bench Cable (see Section 3.1.2) to the mini-USB port on the Vue Pro camera. Connect the RCA plug on the Bench Cable to an analog video monitor. Connect the USB (Type-A) connector on the Bench Cable to an available USB port on your computer.

4.2.2 COTS mini-USB Cables

FLIR Vue Pro is compatible with many commercial off-the-shelf (COTS) 10-pin mini-USB cables that are used to provide power to, and receive video from, action cameras commonly mounted on small unmanned aerial systems (sUAS). FLIR does not provide this cable as every sUAS installation is unique. Please refer to the Vue Pro Technical Drawing for electrical interface guidelines and USB connector pinout.

Simply plug the chosen cable into the mini-USB port on the FLIR Vue Pro, connect power to an appropriate regulated power supply, and video to a downlink, if desired. Approximate operating current of the Vue Pro camera is 420 mA at 5Vdc. Inrush current can reach as high as 600 mA.

Note: FLIR Vue Pro does not have over-voltage or reverse polarity protection on power or video pins. Only use a filtered, regulated 5Vdc power source with the FLIR Vue Pro! Applying more than 6Vdc, reversing polarity, or applying power to video pins will damage the camera and void the warranty.

4.2.3 FLIR Vue Pro Power & Video Adapter (HDMI Converter)

The Vue Pro HDMI Converter is a power and video adapter accessory (FLIR part number 4206334) for the Vue Pro that expands the input voltage range of the camera. It accepts input voltages between 5 and 32Vdc and regulates it down to the required 5Vdc. It also provides reverse polarity protection. This accessory also provides up-scaled 720p60 video via a micro HDMI connector. It adds approximately 15 grams to the weight and 11 mm to the width of the camera. It also utilizes the two M2 mounting holes on the side of the Vue Pro camera.



Figure 7. HDMI Converter (FLIR pn 4206334)

436-0013-10, Rev. 110 Vue Pro and Vue Pro R User Guide
Information on this page is subject to change without notice



The World's Sixth Sense™

www.itm.com

information@itm.com

FLIR Vue Pro and Vue Pro R User Guide

4.3 Software Interface

The Vue Pro camera is configured and operated through a mobile device APP. See Section 5 for additional details.

Note: The Vue Pro camera is not compatible with the FLIR Camera Controller User Interface software. When connected to the USB port on a computer, the camera appears as a mass storage device only.

There is no Software Developer’s Kit or API available for the camera.

4.4 Connecting to a MAVLink Compatible Flight Controller

The FLIR Vue Pro camera is software- and connector-compatible with many MAVLink autopilots using the included Accessory Cable. Other flight controllers or I/O modules may require different cables or connectors. Refer to the FLIR Vue Pro Technical Drawing for detailed information.

Please see Section 5.1.8.2 for port configuration.

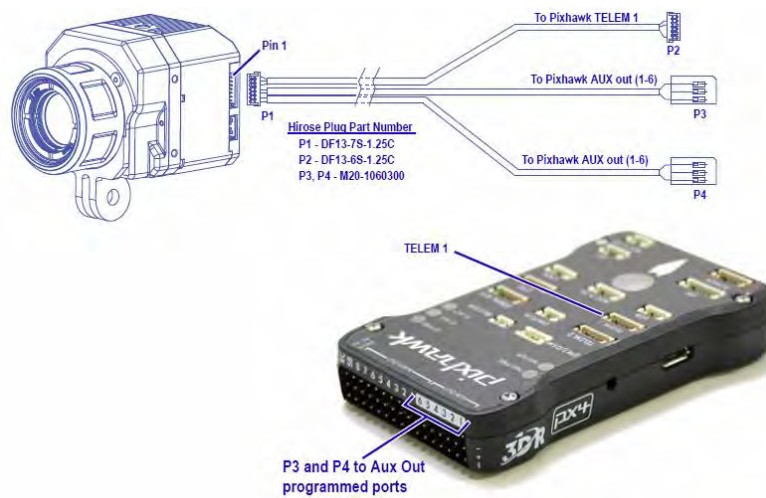

Figure 8. PixHawk Flight Controller

P1 - Accessory Port (DF13-7S-1.25C)		Wire color	P2 - MAVLink (DF13-6S-1.25C)		P3 - AUX Out (M20-1060300)		P4 - AUX Out (M20-1060300)	
PWM_1	1	green	RX in	3				
PWM_2	2	white	TX out	2				
GND	3	black	GND	6				
PWM_3	4	orange			PWM_3	1		
GND	5	black			GND	3		
PWM_4	6	blue					PWM_4	1
GND	7	black					GND	3

Note: All cable plug part numbers are Hirose

Table 1. Accessory Cable Pinout Definition

436-0013-10, Rev. 110 Vue Pro and Vue Pro R User Guide

Information on this page is subject to change without notice



The World’s Sixth Sense™

FLIR Vue Pro and Vue Pro R User Guide

4.5 Camera Operation

The camera does not have an on or off switch. When power is applied, IR video will start in less than five seconds and the Bluetooth radio will be enabled in roughly 30 seconds (three beeps are sounded and the Bluetooth LED is lit blue).

- When power is applied to the camera, the Status LED blinks red for approximately 30 seconds, then changes to solid blue. When this happens, Bluetooth becomes enabled. FLIR Vue Pro beeps three times and the Record LED goes from off to solid green. (If the FLIR Vue Pro is connected to a computer, the Record LED blinks yellow.)
- Launch the APP on the mobile device. Use the APP to configure any desired camera settings and then disable the Bluetooth radio in preparation for flight. The Vue Pro will automatically disable the Bluetooth radio after 2 minutes if no commands are received from the APP. It can be re-started by pressing the Bluetooth button on the camera.

Note: The Bluetooth interface is only intended to be used for ground operations. FLIR does not recommend flying while Bluetooth is enabled.

- FLIR Vue Pro is now ready for use. Press the Record button on the camera or in the APP to start recording or use PWM signals setup on the autopilot. The Record LED blinks while recording video, or flashes yellow each time it captures a still image.

See Section 5 for instructions on how to adjust camera modes, video/still image formats, PWM settings, and other configuration options using the FLIR Vue Pro Application.



Figure 9. Camera Status and Record LED Description

Simultaneously pressing both the start/stop and Bluetooth buttons for 5 seconds will cause the system to reboot and do a hard reset restoring all factory default settings.

FLIR Vue Pro and Vue Pro R User Guide

5 The FLIR Vue Pro APP

The FLIR Vue Pro APP is the primary control interface available for the Vue Pro camera. It is compatible with many mobile devices equipped with Bluetooth LE running iOS 8.0 or later and Android V 4.3 or above.

5.1 Home Screen

When launched, the FLIR Vue Pro APP will connect to the camera and the Home screen will be displayed (or the last screen accessed). The Home screen shows camera status and allows choosing the Color Palette, Scene Preset and Manual Controls, and Record Mode (video, still, or timelapse). The current PWM states are also displayed here.

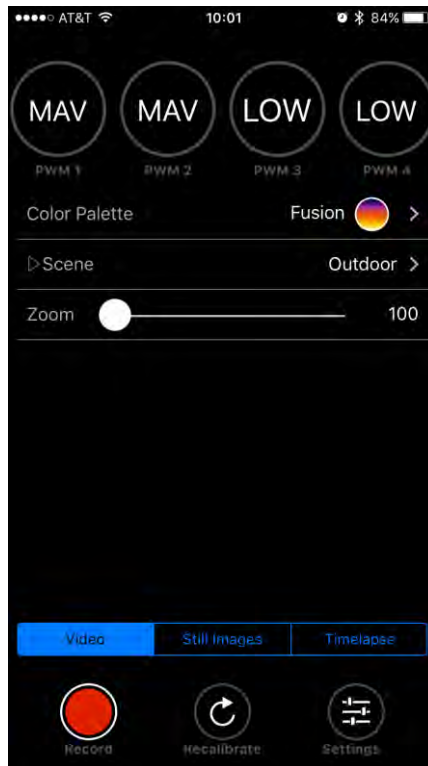

Figure 10. Home Screen

FLIR Vue Pro and Vue Pro R User Guide

5.1.1 Color Palette

The Vue Pro detects and images long wave infrared radiation. Within the camera, this radiation is mapped (as determined by the Scene Preset selected) to a range of 255 colors. In a black and white palette, this range is converted to shades of gray with 0 being totally black and 255 being totally white. Different palettes are available to change the appearance of the image. The most common selection is either White Hot (hotter objects appear brighter than cooler objects) or Black Hot (hotter objects appear darker than cooler objects).

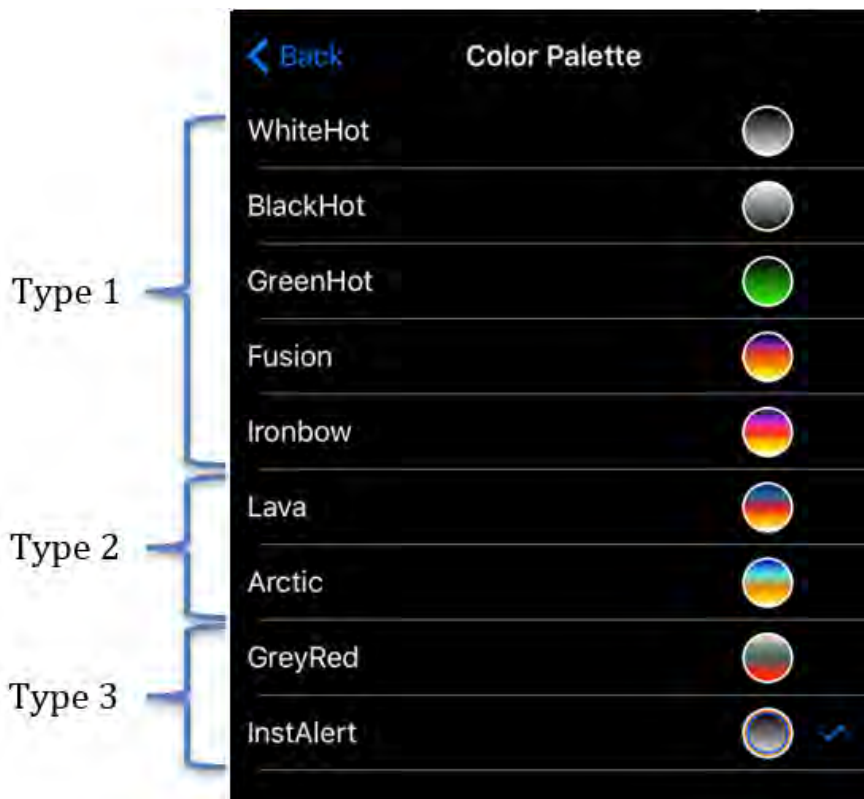

Figure 11. Color Palettes

There are three main types of palettes offered in the Vue Pro camera. If an error is received while attempting to select a particular color palette, that selection may not be available in your camera.

1. Linear: Scene radiation is mapped to pixel values where color is uniformly distributed from one shade to another as pixel intensity increases. These palettes are the most common palettes for general use: WhiteHot, BlackHot, GreenHot, Fusion, Ironbow
2. Contrast: Enhances observed contrast by mapping pixel values to divergent color schemes. Subtle differences between object temperatures become more apparent. Lava, Arctic.
3. Alert: Helps draw attention to the hottest subjects in a scene by applying high-contrast color values to an otherwise linear distribution. GreyRed, InstAlert.

FLIR Vue Pro and Vue Pro R User Guide

5.1.2 Scene

Each Scene preset provides a combination of automatic gain control (AGC) settings which have been optimized by FLIR Systems to provide the best image for a particular application. In many cases, selecting a particular Scene preset will be all the camera setup that is required. However, these settings are intended to be used as guidelines and are not guaranteed to be the optimum values for any particular scenario. Depending upon scene content and viewing/recording preferences, individual settings may be further optimized.

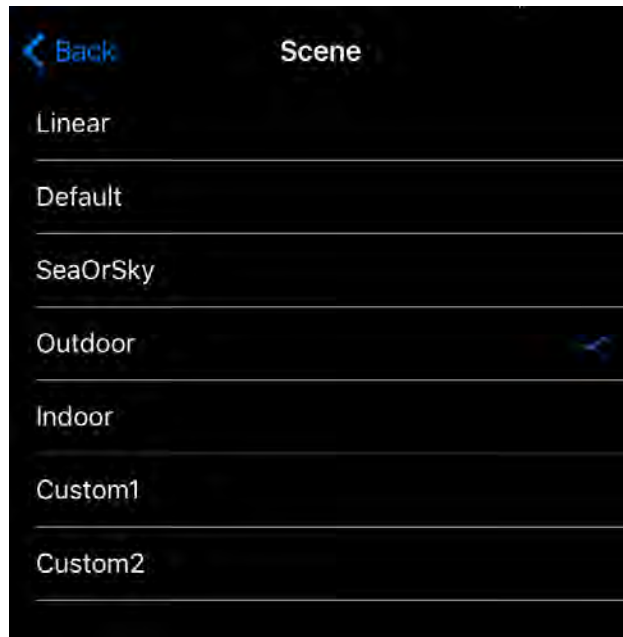

Figure 12. Scene Presets

The Vue Pro camera includes the following Scene presets:

1. Linear
2. Default
3. SeaOrSky
4. Outdoor
5. Indoor
6. Custom1
7. Custom2

Scene Algorithms have been tuned for each preset. Each option has its own set of image parameters. When switching between Scene settings, the camera requires a second or two to load them. If unsure which setting to use, select Default.

FLIR Vue Pro and Vue Pro R User Guide

5.1.3 Manual Controls

Manual controls are available to fine-tune the image for a particular scene. Manual adjustment is not required but it has the possibility of optimizing the image to bring out key details in a scene. Toggling the Scene icon will expose the options listed below.

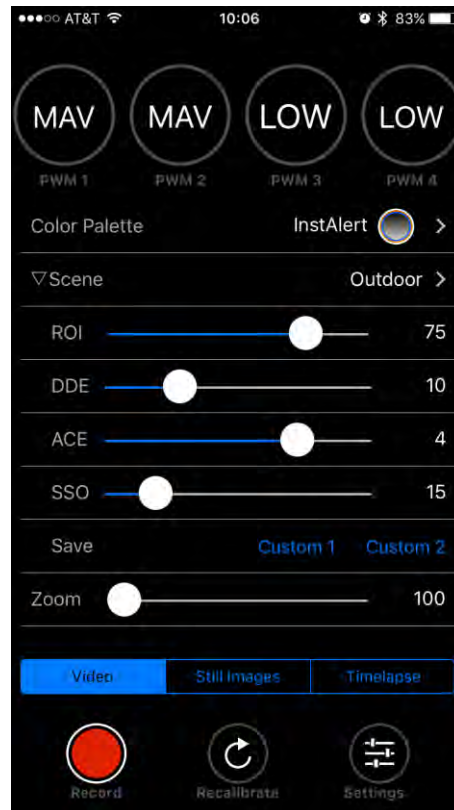

Figure 13. Manual Scene Controls

5.1.3.1 ROI

The ROI slider allows the user to set a region of interest (a rectangular area of pixels on the sensor array) that the Scene algorithm will use for its calculations. This rectangular area can be configured so that varying amounts of sky will be excluded. When set to **100**, the full field of view will affect the image. A setting of **50** will exclude the top half of the image.

Setting the ROI to **Locked** (moving the slider all the way to the left) will freeze the Scene settings so that changes in image content will not alter the apparent brightness and contrast. This will also suspend FFC events. Operating in this mode could negatively impact image quality. A manual FFC can be performed to refresh the image.

5.1.3.2 DDE

Digital Detail Enhancement (DDE) is an algorithm which can be used to enhance image details and/or suppress fixed pattern noise. DDE parameters are computed automatically based on scene content and range from -20 to 100. Higher values represent higher degrees of detail enhancement. If no enhancement is desired, a value of 0 should be set. Values greater than 0 sharpen the image,

436-0013-10, Rev. 110 Vue Pro and Vue Pro R User Guide
Information on this page is subject to change without notice



The World's **Sixth Sense**™

FLIR Vue Pro and Vue Pro R User Guide

while values less than 0 soften the image and filter fixed pattern noise. Although large values of DDE will significantly enhance the edges of objects in the scene, it can also raise the fixed pattern noise in the image.

5.1.3.3 ACE

The Active Contrast Enhancement (ACE) feature provides a contrast adjustment dependent on the relative scene temperature. ACE thresholds greater than 0 impart more contrast to hotter scene content and decrease contrast for colder scene content (e.g. sky or ocean). ACE threshold settings less than 0 do the opposite by decreasing contrast for hotter scene content and leaving more of the gray-scale shades to represent the colder scene content. ACE can range from -8 to 8 where -8 decreases contrast in darker regions while +8 increases contrast in darker regions. Although individual operator preferences may vary, FLIR recommends to use positive values of ACE when selecting WhiteHot-based color palettes and negative values when selecting BlackHot. Color-based palettes typically require only small (if any) changes to ACE.

5.1.3.4 SSO

The Smart Scene Optimization (SSO) value defines the percentage of colors that will be linearly mapped. With SSO enabled, the difference in gray shades between two objects is more representative of the difference in temperature. SSO helps to set how linear the Scene algorithms are to provide the highest amount of perceived contrast in every scene. SSO can range from 0 to 100%.

5.1.3.5 Save Custom Scene Presets

Two user configurable Scene presets are provided. Saved settings include Scene algorithm, ROI, DDE, ACE, and SSO. The **Save** buttons store the presets, while the **Custom** selections (on the Scene page) recall them. To use this feature, begin by selecting the desired Scene preset. Once selected, the Scene preset can be further optimized using the manual control sliders (Section 0). Record the desired settings by hitting the Save button.

5.1.4 Zoom

View Pro cameras have up to 4x (slider setting of 400) digital zoom on the analog output with associated on-screen symbology. For example, a Vue Pro 336 in NTSC uses the center 320 x 240 pixels of the sensor for analog video. 2x (slider setting of 200) zoom mode will interpolate the center 160 x 120 pixels onto the video stream. Digital zoom setting has no effect on recorded imagery.

5.1.5 Video/Still Image/Timelapse

The Video, Still Images, and Timelapse tabs configure the Vue Pro's data bus for recording either still images or live video. The system cannot capture a still image during recording of video (or vice versa). The Record button is used to start and stop all file captures.

5.1.5.1 Video

Video can be recorded in 8-bit MJPEG or H.264, or monochrome 14-bit TIFF sequence files. TIFF sequences can be captured at roughly 2 frames per second. Under most conditions, H.264 provides superior 8-bit performance.

FLIR Vue Pro and Vue Pro R User Guide

5.1.5.2 Still Images

Configures image capture at a user-selectable interval from one frame (slider setting of “Single”) up to one every 60 seconds.

5.1.5.3 Timelapse

Configures image capture at a user-selectable period and framerate. Timelapse sequences are captured as any available Video file type.

- **Period:** Delay between captured images. Range: 1 – 60 seconds.
- **Playback Speed:** Framerate still images are replayed. Range: 1 – 60 frames per second.

5.1.6 Record

The Record button either captures a still image, or starts/stops live video recording. See Section 6 for details on available file formats.

5.1.7 Recalibrate

To maintain optimum performance, thermal imaging cameras occasionally must perform an internal calibration. This is accomplished using an internal shutter and takes less than 1 second. A warning is provided onscreen 1-2 seconds prior to this event and can be seen in the upper right hand corner of the image. During re-calibration, an audible “click” can be heard and live video is frozen. This function takes place either automatically, based on internal camera parameters, or can be manually initiated by the user through one of the available interfaces.

A user may find recalibrating prior to taking critical measurements will ensure best performance.

FLIR Vue Pro and Vue Pro R User Guide

5.1.8 Settings

The Settings button is used to configure the operational parameters of the Vue Pro camera.

5.1.8.1 Main

- **Video File Type:** Select MJPEG, H.264 or TIFF. See Section 6 for more details.
- **Analog Video Format:** Select NTSC or PAL as the format of the video that is output to the 10-pin mini USB port. This setting does not affect the format of the video that is saved to the microSD card.
- **Still Image Type:** Select formats for still images and video saved to the microSD card (See Section 6).
- **Flip Horizontal/Vertical:** Select image orientation. To mount the camera upside down, flip both Horizontal and Vertical. For a rear-facing application (and the effect of looking at a rear-view mirror), flip only horizontal.
- **Speaker on Record Stop:** Turns on/off the audible indicator for video recording. Even when turned off, the speaker will beep three times when the camera is ready after power-up.
- **Speaker on Still Image Record:** Turns on/off the audible indicator. Even when turned off, the speaker will beep three times when the camera is ready after power-up.
- **Enable LED:** Turns on/off the Status and Bluetooth LEDs. LED indicators will still be displayed while camera is booting up if this setting is turned off.

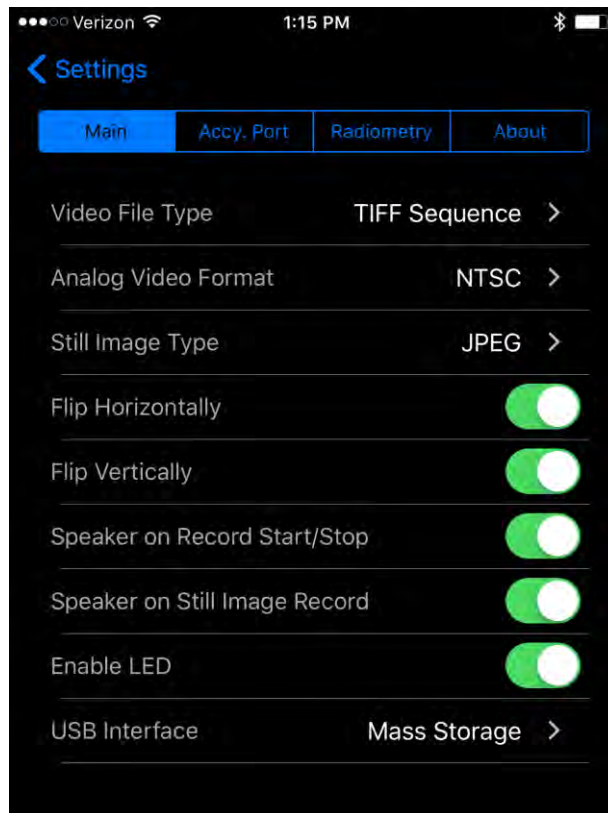

Figure 14. Main Settings

436-0013-10, Rev. 110 Vue Pro and Vue Pro R User Guide
Information on this page is subject to change without notice



The World's Sixth Sense™

www.itm.com

information@itm.com

FLIR Vue Pro and Vue Pro R User Guide

5.1.8.2 Accessory Port I/O

- PWM: Using the accessory port on the Vue Pro and the included Accessory Cable (see Section 3.1.4), camera functions can be controlled directly from the sUAS flight controller via PWM signals (refer to the controller manual for configuration instructions, as every brand of controller is a little different). Select the desired setting from the list of available PWM functions. **No two channels can be assigned to the same function.** Any functions currently assigned to PWM channels will not appear in the list of available functions for other channels. PWM 3 and PWM 4 are the channels available with the Vue Accessory Cable.

To configure, select the **Settings** button on the Main page. Select the **Accy. Port** tab at the top of the page. Ensure Serial Protocol is set to PWM. Select a PWM channel to configure (Figure 15). Select the desired function. Select the number of states (Figure 16). The number of states will depend on the type of switch that is being mapped on the flight controller. For a three-position switch, the number of states will be three. Assign functions to the available states for each signal. Next, program the flight controller to provide signals to the Aux Out ports for the P3 and/or P4 connectors on the Accessory Cable.

The Vue Pro accepts standard PWM inputs for the R/C industry, 3.3-5vdc, 50Hz. LOW = 1ms/20ms, MID = 1.5ms/20ms, HIGH = 2ms/20ms.



Figure 15. PWM Settings

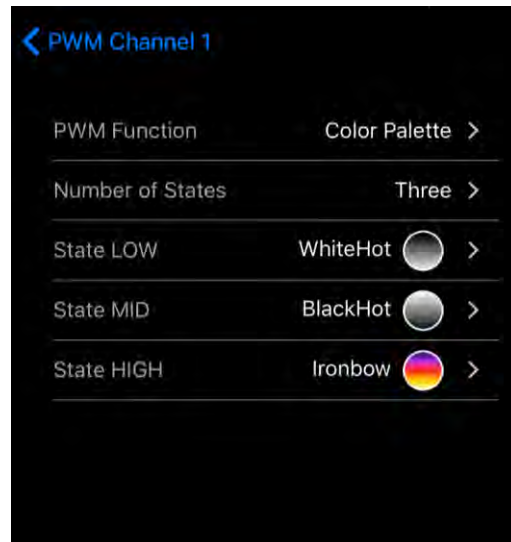

Figure 16. Function Selection

FLIR Vue Pro and Vue Pro R User Guide

- MAVLink: Many UAS flight controllers support the MAVLink serial protocol to provide an interface with external components. The Vue Pro can be configured to use this bus to capture available telemetry data provided by GPS, altimeter, accelerometers, etc. This data is saved as standard EXIF metadata in Still Image files (JPEG & TIFF). This data is not saved to Video files as there is no current standard for doing this. Metadata is accessible thru standard photo editing applications, file explorers, and suggested mapping applications (see section 6.3).

The following MAVLink 3.0 commands are currently supported by the Vue Pro FW 1.2.4:

Command	MAVLink ID	R/S(Receive/Send)	Notes
HEARTBEAT	0	R/S	
PING	4	R/S*	If Vue Pro has received PING, then will reply with a PING
SYSTEM_TIME	2	R	
ATTITUDE	30	R	
GLOBAL_POSITION_INT	33	R	
GLOBAL_POSITION_INT_COV	63	R	
HIL_GPS	113	R	
MOUNT_STATUS	158	R	

FLIR Vue Pro communicates on the MAVLink bus at 57600 baud which is standard for most devices. Where possible, ensure RTSCTS is disabled as this is known to cause issues with communication. The included Accessory Port cable PN 4142156 is pre-terminated to connect properly with the 3DR PixHawk TELEM 1 port. If this port is already in use, see the [PixHawk documentation](#) for information on how to reconfigure ports. If all available flight controller ports are full, you may need to investigate using a splitter cable to attach additional devices. Please refer to Table 1 for Accessory Port pin-out when building custom cables.

Vue Pro can operate in a receive only configuration much like an OSD, and therefore does not require the TX pin from the camera to be connected to the RX pin on a flight controller. Please note that some flight controllers (3DR Solo) will sleep a serial port if no connection is detected. Please plan accordingly when setting up your system.

Please see Appendix B for the full MAVLink protocol implementation.

FLIR Vue Pro and Vue Pro R User Guide

5.1.8.3 Radiometry

The Radiometry tab provides access to all the temperature measurement functions and settings available on the Vue Pro R. If connecting to a standard Vue Pro camera, this tab will not be visible and these features are unavailable. See FLIR’s UAS Radiometry Tech Note (see Section 2.2 for the link) for a detailed discussion on how to obtain accurate temperature readings for UAS applications.

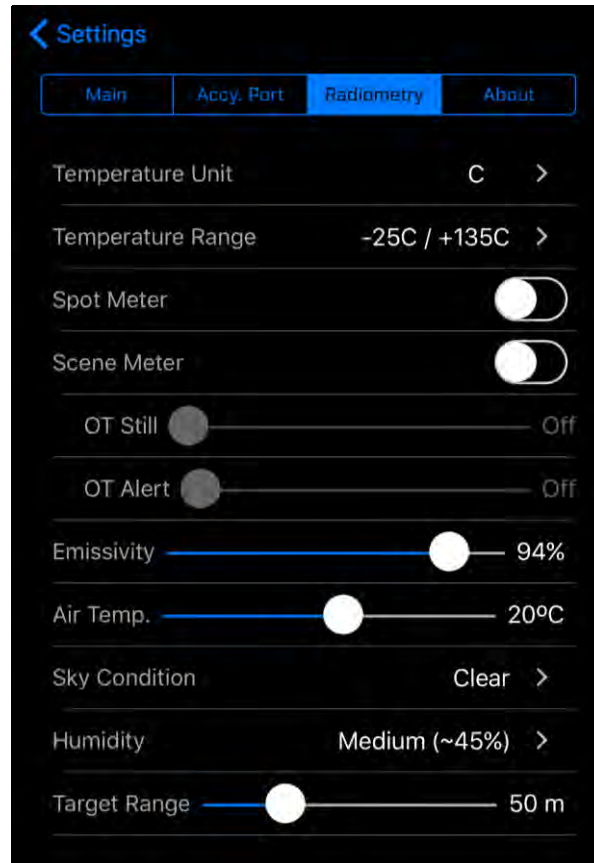

Figure 17. Radiometry Tab

- **Temperature Unit** – Units of measure displayed on the analog video. Select between Celsius and Fahrenheit.
- **Temperature Range** – This setting adjusts the camera sensitivity and dynamic range to provide optimum image quality. When in Auto mode the camera analyzes the scene and selects between states, based on scene conditions. Ambient temperature of the camera influences the performance of this setting. However, approximate detectable temperature ranges are as follows:
 - -25/+135°C (-13/+275°F)
 - -40/+550°C (-40/+1022°F)

Unless extreme temperatures are expected to be encountered (i.e. fires), keep this setting configured in the Auto position.

436-0013-10, Rev. 110 Vue Pro and Vue Pro R User Guide
Information on this page is subject to change without notice



The World's Sixth Sense™

www.itm.com

information@itm.com

FLIR Vue Pro and Vue Pro R User Guide

- **Spot Meter** – Turns on or off the spot meter (fixed 4x4 pixel array) in the center of the image, the on-screen thermometer on the left edge of the image, and the digital temperature in the lower left corner of the image (Figure 18). The spot consists of a 4x4 pixel array that is averaged to provide the measurement.



Figure 18. Spot Meter OSD

- **Scene Meter** – The Min and Max temperatures in the center 75% of the scene are actively identified and labeled by 4x4 pixel indicators. The specific values of these points are provided on screen in the lower left hand corner, and color coded to the labeled points in the image (Figure 19). There is approximately 1 second of latency to process the scene which can lead to some lag and should be considered during use.



Figure 19. Scene Meter OSD

436-0013-10, Rev. 110 Vue Pro and Vue Pro R User Guide
Information on this page is subject to change without notice



The World's **Sixth Sense**™

www.itm.com

information@itm.com

FLIR Vue Pro and Vue Pro R User Guide

- **OT Still** – Records a still image any time the **Max:** value in the Scene Meter is greater than the threshold. Values from 0 to 300° C (32 to 572° F) can be configured. The feature can also be disabled by setting it to **Off**.
- **OT Alert** – When a temperature in the scene is detected that is greater than the threshold, the **Max:** Scene Meter label flashes. Values from 0 to 300° C (32 to 572° F) can be configured. The feature can also be disabled by setting it to **Off**.
- **Emissivity** – Measure of the target surface ability to emit thermal energy. Values from 50-100% can be configured.
- **Air Temp.** – Ambient temperature of the operating environment. Values from 0 to 40° C (32 to 104° F) can be configured.
- **Sky Condition** – Measure of the cloud cover above the operating site. This affects the background radiation incident on the scene. Clear, Scattered and Cloudy are input values.
- **Humidity** – Relative moisture content of the air. Three settings are available; Low (30%), Medium (45%), High (60%).
- **Target Range** – Distance from the camera to the target in the scene. Values from 0-200m (0-218 yards) can be configured.

5.1.8.4 About

The About screen provides information on the current software installed on the Vue Pro, as well as the App version.

- **Part Number** – FLIR part number of the Vue Pro camera currently connected to the app.
- **Serial Number** – Vue Pro camera serial number currently connected to the app.
- **Firmware Version** – Version of firmware currently loaded in the Vue Pro camera.
- **FW Upgrade Version** - Detects if a camera upgrade file exists on the microSD card. If one is available, the Upgrade Available dialog will start. Choose Yes to begin the upgrade process. See Appendix A for details on how to upgrade camera firmware.
- **App Version** - Version of software currently loaded on the mobile device.
- **App Upgrade Version** – If the mobile device is connected to the Internet, the Vue Pro app will automatically search for any available app updates. If one exists, the user will have the option to update by following the link to the FLIR web page.
- **Persistent Bluetooth** – Prevents the Bluetooth interface from shutting off after 2 minutes.
- **Reset To Factory Defaults** – Resets settings in the Vue Pro camera to original factory configuration. This is required during most FW updates as the internal memory map will change as new features are added.
- **Disable Bluetooth:** Powers down the Bluetooth radio on the camera. The camera will normally disable the Bluetooth after two minutes of inactivity. See Persistent Bluetooth.
- **Bluetooth Power** – Adjusts the Bluetooth transmitter power and affects the maximum range at which the Vue Pro camera can connect to the mobile device. Power values are expressed in percent.

FLIR Vue Pro and Vue Pro R User Guide

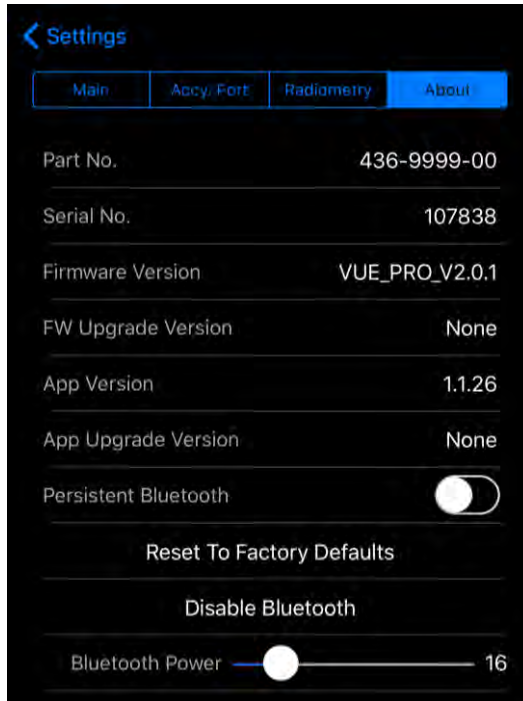

Figure 20. About Page

It also detects if a camera upgrade file exists on the microSD card. If one is available, the Upgrade Available dialog will start. Choose Yes to begin the upgrade process.



Figure 21. Upgrade Available

FLIR Vue Pro and Vue Pro R User Guide

6 File Formats

The Vue Pro can save image data in a number of file formats, each with unique characteristics.

6.1 JPEG

The JPEG format of the Vue Pro has both the compressed 8-bit processed JPG image and 14-bit raw sensor data in a single file. The 8-bit image has Scene and Palette processing applied. If a compatible flight controller is available telemetry will be captured and saved in standard metadata fields.

6.2 TIFF

TIFF is uncompressed 14-bit raw sensor data with no post processing. If a compatible flight controller is available telemetry will be captured and saved in standard metadata fields.

File Format	Feature					Use	Applications
	8-bit	14-bit	Scene/AGC	Palette	Telemetry		
Still Image Files							
JPEG	√	√	√	√	√	Reporting, Research	FLIR Tools, ResearchIR, any image tool
TIFF		√			√	Mapping, Research	Pix4D, Drone Deploy, Matlab, ImageJ
Video Files							
MJPEG	√		√	√		Reporting	Any video tool
H.264	√		√	√		Reporting	Any video tool
TIFF-Seq		√				Mapping, Research	ResearchIR, Matlab, ImageJ

Table 2. Image Formats Recorded on microSD Card

FLIR Vue Pro and Vue Pro R User Guide

7 Care of FLIR Vue Pro

- Only power FLIR Vue Pro with a regulated 5 Vdc power source. Using more than 6 Vdc will damage the camera and void the warranty.
- Do not touch the lens. If the lens gets dirty, a light dusting of air should dislodge any dust particles. If the lens is still noticeably dirty, use 75% Isopropyl alcohol and lens tissue. Use a light wiping motions with a fresh section of lens tissue with each swipe so as not to drag dust or dirt particles back over the lens surface.
- Do not remove the lens. Dirt and dust can settle on the interior surfaces of the camera and degrade performance.
- FLIR Vue and Vue Pro cameras have been focused at the factory and optimized for the maximum range performance of each camera/lens pair using a collimated bar target. Although it is possible to adjust the focus, doing so may compromise the external seal of the camera and factory focus will be lost. A special tool is required in order to prevent damage to the lens housing or front detector element.
- FLIR Vue Pro is neither water nor dust resistant. Care for it as you would any valuable piece of electronics equipment.

If you have questions about your Vue Pro or Vue Pro R camera, contact
FLIR Tech Support at **1-866-667-7732**.

Appendix A - Software and Firmware Update

How to Update APP

Download the latest handset application from the appropriate web store for your platform. Some handy links are listed below. Also be sure to keep the OS up to date on your device as Bluetooth is an evolving protocol and receives continuous improvements.

iOS APP store ([Web Link](#))

Android APP store ([Web Link](#))

Android APK file direct DL ([Web Link](#))

How to update Firmware (FW)

Vue Pro Firmware Upgrade Procedure

1. Backup Vue Pro settings. Connect to the Vue Pro with the Bluetooth application and make note of all your settings. The firmware upgrade will reset the camera settings to defaults since we typically are adding features and the previous settings may not be optimal for your application.
2. Download firmware update. Download then save the firmware upgrade onto the camera micro SD card either by connecting your Vue Pro to a computer with the included Bench cable, or through another suitable micro SD card reader.
3. Power on Vue Pro. Power on the Vue Pro and wait for it to complete the boot cycle (you'll hear the three beeps and see the Bluetooth light go steady blue and the Record light go steady red). If the Bluetooth radio does not enable, press the button to turn it on. You will see a blue light.
4. Start update process. Open the Vue Pro app and connect to the camera. The app will read the camera's settings, then display the Firmware update message (Figure 22). Select "Yes" to begin the update. The Bluetooth light will flash purple for 30-45 seconds while it's updating, then the camera will re-boot. During this time, you will see an Upgrading message, and then the Bluetooth disconnect message. It is important to NOT remove power to the camera during the upgrade process.



Figure 22. Firmware Upgrade

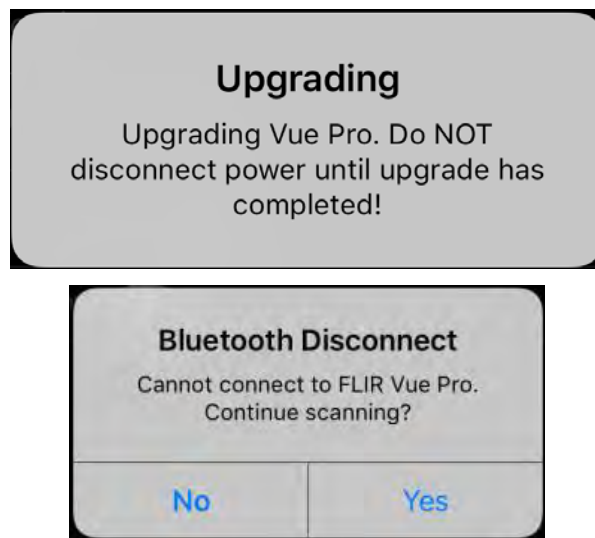

Figure 23. Upgrading and Bluetooth Disconnect Messages

5. Reconnect via Bluetooth. Once rebooted, reconnect your handset to the camera by selecting 'Yes' from the Bluetooth Disconnect dialogue (). The camera should reconnect and present you with the Main screen. If you previously selected 'No' in this dialogue you will need to force quit and restart the APP on your handset.

FLIR Vue Pro and Vue Pro R User Guide

6. Reset to factory defaults. **This step is very important so please do not forget to perform the task.** Select the Advanced button in the lower left of the screen, then the About tab, and finally 'Reset to Factory Defaults' button. A warning box will be presented, please select 'Yes'. All the files on the micro SD card will be preserved, only the flash memory on the Vue Pro camera will be reset. This will ensure proper operation of the camera with the new firmware.
7. Restore User Settings. From your notes in Step 1 reconfigure any Main, PWM or Accessory Port settings for your specific application. You can also delete the firmware update file from your microSD card.

FLIR Vue Pro and Vue Pro R User Guide

Appendix B - MAVLink Implementation

HEARTBEAT (0)

Field Name	ENUM	Type	Official Description	FLIR Implementation
System ID			MAVlink packet Byte 3	1
Component ID			MAVlink packet Byte 4	100
Type	MAV_TYPE	uint8_t	MAV_TYPE_GENERIC - Generic micro air vehicle.	0
Autopilot	MAV_AUTOPILOT	uint8_t	MAV_AUTOPILOT_INVALID - No valid autopilot, e.g. a GCS or other MAVLink component	8
Base Mode	MAV_MODE_FLAG	uint8_t	MAV_MODE_FLAG_MANUAL_INPUT_ENABLED - 0b01000000 remote control input is enabled.	64
Custom Mode		uint32_t	A bitfield for use for autopilot-specific flags.	0
System Status	MAV_STATE	uint8_t	MAV_STATE_ACTIVE - System is active and might be already airborne. Motors are engaged.	4
MAVLink Version		uint8_t	MAVLink version, not writable by user	default

PING (4)

Field Name	ENUM	Type	Official Description	FLIR Implementation
Time Unix		uint64_t	Timestamp (microseconds since UNIX epoch or microseconds since system boot)	Ignored
Sequence		uint32_t	PING sequence	Same as official
System ID		uint8_t	0: request ping from all receiving systems, if greater than 0: message is a ping response and number is the system id of the requesting system	See description above
Component ID		uint8_t	0: request ping from all receiving components, if greater than 0: message is a ping response and number is the system id of the requesting system	See description above

SYSTEM_TIME (2)

Field Name	ENUM	Type	Official Description	FLIR Implementation
Time Unix		uint64_t	Timestamp of the master clock in microseconds since UNIX epoch.	If time is valid, it will be set to the device.
Time Boot		uint32_t	Timestamp of the component clock since boot time in milliseconds.	Ignored

436-0013-10, Rev. 110 Vue Pro and Vue Pro R User Guide
 Information on this page is subject to change without notice



The World's Sixth Sense™

FLIR Vue Pro and Vue Pro R User Guide

ATTITUDE (30)

Field Name	Type	Official Description	FLIR Implementation
Time Boot	uint32_t	Timestamp (milliseconds since system boot)	Ignored
Roll	float	Roll angle (rad, -pi..+pi)	Meta = MAV Roll
Pitch	float	Pitch angle (rad, -pi..+pi)	Meta = MAV Pitch
Yaw	float	Yaw angle (rad, -pi..+pi)	Meta = MAV Yaw
Roll Rate	float	Roll angular velocity (rad/s)	Meta = MAV Roll Rate
Pitch Rate	float	Pitch angular velocity (rad/s)	Meta = MAV Pitch Rate
Yaw Rate	float	Yaw angular velocity (rad/s)	Meta = MAV Yaw Rate

GLOBAL_POSITION_INT (33)

Field Name	Type	Official Description	FLIR Implementation
Time Boot	uint32_t	Timestamp (milliseconds since system boot)	Ignored
Latitude	int32_t	Latitude, expressed as * 1E7	Meta = GPS Latitude
Longitude	int32_t	Longitude, expressed as * 1E7	Meta = GPS Longitude
Altitude (MSL)	int32_t	Altitude in meters, expressed as * 1000 (millimeters), AMSL (not WGS84 - note that virtually all GPS modules provide the AMSL as well)	Meta = GPS Altitude
Altitude (Relative)	int32_t	Altitude above ground in meters, expressed as * 1000 (millimeters)	Meta = MAVRelativeAltitude
Velocity X	int16_t	Ground X Speed (Latitude), expressed as m/s * 100	Calc = GPS Speed
Velocity Y	int16_t	Ground Y Speed (Longitude), expressed as m/s * 100	Calc = GPS Speed
Velocity Z	int16_t	Ground Z Speed (Altitude), expressed as m/s * 100	Calc = GPS Speed
Heading	uint16_t	Compass heading in degrees * 100, 0.0..359.99 degrees. If unknown, set to: UINT16_MAX	Meta = GPS Track

GLOBAL_POSITION_INT_COV (63)

Field Name	Type	Official Description	FLIR Implementation
------------	------	----------------------	---------------------

436-0013-10, Rev. 110 Vue Pro and Vue Pro R User Guide
 Information on this page is subject to change without notice



The World's Sixth Sense™

FLIR Vue Pro and Vue Pro R User Guide

Time Boot		uint32_t	Timestamp (milliseconds since system boot)	Ignored
Time Unix		uint64_t	Timestamp (microseconds since UNIX epoch) in UTC. 0 for unknown.	Ignored
estimator_type	MAV_ESTIMATOR_TYPE	uint8_t	Class id of the estimator this estimate originated from.	Ignored
Latitude		int32_t	Latitude, expressed as * 1E7	Meta = GPS Latitude
Longitude		int32_t	Longitude, expressed as * 1E7	Meta = GPS Longitude
Altitude (MSL)		int32_t	Altitude in meters, expressed as * 1000 (millimeters), AMSL (not WGS84 - note that virtually all GPS modules provide the AMSL as well)	Meta = GPS Altitude
Altitude (Relative)		int32_t	Altitude above ground in meters, expressed as * 1000 (millimeters)	Meta = MAVRelativeAltitude
Velocity X		float	Ground X Speed (Latitude), expressed as m/s * 100	Calc = GPS Speed
Velocity Y		float	Ground Y Speed (Longitude), expressed as m/s * 100	Calc = GPS Speed
Velocity Z		float	Ground Z Speed (Altitude), expressed as m/s * 100	Calc = GPS Speed
covariance		float[36]	Covariance matrix (first six entries are the first ROW, next six entries are the second row, etc.	Ignored

HIL_GPS (113)

Field Name		Type	Official Description	FLIR Implementation
time_usec		uint64_t	Timestamp (microseconds since UNIX epoch or microseconds since system boot)	Ignored
fix_type		uint8_t	0-1: no fix, 2: 2D fix, 3: 3D fix. Some applications will not use the value of this field unless it is at least two, so always correctly fill in the fix.	Ignored
lat		int32_t	Latitude (WGS84), in degrees * 1E7	Meta = GPS Latitude
lon		int32_t	Longitude (WGS84), in degrees * 1E7	Meta = GPS Longitude
alt		int32_t	Altitude (AMSL, not WGS84), in meters * 1000 (positive for up)	Meta = GPS Altitude
eph		uint16_t	GPS HDOP horizontal dilution of position in cm (m*100). If unknown, set to: 65535	Meta = GPSXYAccuracy
epv		uint16_t	GPS VDOP vertical dilution of position in cm (m*100). If unknown, set to: 65535	Meta = GPSZAccuracy
vel		uint16_t	GPS ground speed (m/s * 100). If unknown, set to: 65535	Ignored
vn		int16_t	GPS velocity in cm/s in NORTH direction in earth-fixed NED frame	Ignored
ve		int16_t	GPS velocity in cm/s in EAST direction in earth-fixed NED frame	Ignored
vd		int16_t	GPS velocity in cm/s in DOWN direction in earth-fixed NED frame	Ignored



FLIR Vue Pro and Vue Pro R User Guide

cog		uint16_t	Course over ground (NOT heading, but direction of movement) in degrees * 100, 0.0..359.99 degrees. If unknown, set to: 65535	Ignored
satellites_visible		uint8_t	Number of satellites visible. If unknown, set to 255	Ignored

MOUNT_STATUS (158)

Field Name		Type	Official Description	FLIR Implementation
pointing_a		uint32_t	Pitch (deg*100)	Meta = Yaw (camera)
pointing_a		uint32_t	Roll angle (rad, -pi..+pi)	Meta = Pitch (camera)
pointing_a		uint32_t	Pitch angle (rad, -pi..+pi)	Meta = Roll (camera)
Target System		uint8_t	Yaw angle (rad, -pi..+pi)	Ignored
Target Component		uint8_t	Roll angular velocity (rad/s)	Ignored

436-0013-10, Rev. 110 Vue Pro and Vue Pro R User Guide
 Information on this page is subject to change without notice



The World's Sixth Sense™

FLIR Vue Pro and Vue Pro R User Guide

FLIR Commercial Systems, 2011. All rights reserved worldwide. No parts of this manual, in whole or in part, may be copied, photocopied, translated, or transmitted to any electronic medium or machine readable form without the prior written permission of FLIR Commercial Systems

Names and marks appearing on the products herein are either registered trademarks or trademarks of FLIR Commercial Systems and/or its subsidiaries. All other trademarks, trade names, or company names referenced herein are used for identification only and are the property of their respective owners.

Liberation fonts are copyright 2009 by RedHat and are used under authority of the GNU public license. Information about these fonts and the GNU public license can be found at: <https://www.redhat.com/promo/fonts/>.

This product is protected by patents, design patents, patents pending, or design patents pending.

If you have questions that are not covered in this manual, or need service, contact FLIR Commercial Systems Customer Support at 805.964.9797 for additional information prior to returning a camera.

This documentation and the requirements specified herein are subject to change without notice.



This equipment must be disposed of as electronic waste. Contact your nearest FLIR Commercial Systems, Inc. representative for instructions on how to return the product to FLIR for proper disposal.

FCC Notice. This device is a subassembly designed for incorporation into other products in order to provide an infrared camera function. It is not an end-product fit for consumer use. When incorporated into a host device, the end-product will generate, use, and radiate radio frequency energy that may cause radio interference. As such, the end-product incorporating this subassembly must be tested and approved under the rules of the Federal Communications Commission (FCC) before the end-product may be offered for sale or lease, advertised, imported, sold, or leased in the United States. The FCC regulations are designed to provide reasonable protection against interference to radio communications. See 47 C.F.R. §§ 2.803 and 15.1 et seq.

Industry Canada Notice. This device is a subassembly designed for incorporation into other products in order to provide an infrared camera function. It is not an end-product fit for consumer use. When incorporated into a host device, the end-product will generate, use, and radiate radio frequency energy that may cause radio interference. As such, the end-product incorporating this subassembly must be tested for compliance with the Interference-Causing Equipment Standard, Digital Apparatus, ICES-003, of Industry Canada before the product incorporating this device may be: manufactured or offered for sale or lease, imported, distributed, sold, or leased in Canada.

Avis d'Industrie Canada. Cet appareil est un sous-ensemble conçu pour être intégré à un autre produit afin de fournir une fonction de caméra infrarouge. Ce n'est pas un produit final destiné aux consommateurs. Une fois intégré à un dispositif hôte, le produit final va générer, utiliser et émettre de l'énergie radiofréquence qui pourrait provoquer de l'interférence radio. En tant que tel, le produit final intégrant ce sous-ensemble doit être testé pour en vérifier la conformité avec la Norme sur le matériel brouilleur pour les appareils numériques (NMB-003) d'Industrie Canada avant que le produit intégrant ce dispositif puisse être fabriqué, mis en vente ou en location, importé, distribué, vendu ou loué au Canada.

EU Notice. This device is a subassembly or component intended only for product evaluation, development or incorporation into other products in order to provide an infrared camera function. It is not a finished end-product fit for general consumer use. Persons handling this device must have appropriate electronics training and observe good engineering practice standards. As such, this product does not fall within the scope of the European Union (EU) directives regarding electromagnetic compatibility (EMC). Any end-product intended for general consumer use that incorporates this device must be tested in accordance and comply with all applicable EU EMC and other relevant directives.