

**3283**  
**CLAMP ON**  
**LEAK HiTESTER**

---

---

**INSTRUCTION MANUAL**

## Contents

Introduction .....	1
Inspection .....	1
Safety Notes .....	2
Notes on Use .....	5
Chapter Summary .....	11
Chapter 1 Product Outline .....	13
1.1 Product Outline .....	13
1.2 Features .....	13
1.3 Parts and Functions .....	16
Chapter 2 Measurement Procedure .....	19
2.1 Preparations .....	19
2.2 Leak Current Measurement $\hat{A}$ .....	20
2.3 Filter Function FILTER .....	27
2.4 Data Hold Function <b>HOLD</b> .....	28
2.5 Recording Function REC .....	28
2.6 Auto Power-Off Function <b>APS</b> .....	33
2.7 Battery Low Warning <b>B</b> .....	33
2.8 Beep Tone .....	33
2.9 Fast Mode .....	34
2.10 Output Function OUTPUT .....	35
Chapter 3 Battery Replacement .....	39
Chapter 4 Attaching the Hand Strap .....	41
Chapter 5 Specifications .....	43
5.1 Measurement Specifications .....	43
5.1.1 AC current Arms(true rms indication) .....	44
5.1.2 Frequency Hz .....	45
5.2 General Specifications .....	46
Chapter 6 Troubleshooting .....	51
Chapter 7 Service .....	55

---

## Introduction

- Thank you for purchasing the HIOKI "3283 CLAMP ON LEAK HITESTER." To obtain maximum performance from the product, please read this manual first, and keep it handy for future reference.
- We have tried to bring this manual as close to perfection as we could achieve. If perchance you find any unclear portions, mistakes, omissions, or the like, we would be most obliged if you could please notify us of them via any HIOKI agent, or directly.

---

## Inspection

When you receive the product, inspect it carefully to ensure that no damage occurred during shipping. In particular, check the accessories, panel switches, keys, and terminals. If damage is evident, or if it fails to operate according to the specifications, contact your dealer or HIOKI representative.

### Accessories

9399 Carrying Case	1
Hand Strap	1
Battery: 6F22(006P)	1
Instruction manual	1

### Options

9094 OUTPUT CORD	
9445-02 AC ADAPTER	
(SA10-0910N, SINO-AMERICAN)	
9445-03 AC ADAPTER (EU)	
(SA10-0910G, SINO-AMERICAN)	

---

## Safety Notes

### DANGER









---

**This product is designed to conform to IEC 61010 Safety Standards, and has been thoroughly tested for safety prior to shipment. However, mishandling during use could result in injury or death, as well as damage to the product. Be certain that you understand the instructions and precautions in the manual before use. We disclaim any responsibility for accidents or injuries not resulting directly from product defects.**





---

This manual contains information and warnings essential for safe operation of the product and for maintaining it in safe operating condition. Before using the product, be sure to carefully read the following safety notes.

### Safety symbols

	<ul style="list-style-type: none"> <li>The  symbol printed on the product indicates that the user should refer to a corresponding topic in the manual (marked with the  symbol) before using the relevant function.</li> <li>In the manual, the  symbol indicates particularly important information that the user should read before using the product.</li> </ul>
	Indicates AC (Alternating Current).
	Indicates DC (Direct Current).
	Indicates a double-insulated device.
	Wear appropriate protective insulation (insulating rubber gloves and boots, helmet and etc.) when connecting and disconnecting from live electric circuits.

The following symbols in this manual indicate the relative importance of cautions and warnings.

 <b>DANGER</b>	Indicates that incorrect operation presents an extreme hazard that could result in serious injury or death to the user.
 <b>WARNING</b>	Indicates that incorrect operation presents a significant hazard that could result in serious injury or death to the user.
 <b>CAUTION</b>	Indicates that incorrect operation presents a possibility of injury to the user or damage to the product.
 <b>NOTE</b>	Advisory items related to performance or correct operation of the product.

---

**Measurement categories  
(Overvoltage categories)**

This product complies with CAT III safety requirements.

To ensure safe operation of measurement product, IEC 61010 establishes safety standards for various electrical environments, categorized as CAT I to CAT IV, and called measurement categories. These are defined as follows.

CAT I	Secondary electrical circuits connected to an AC electrical outlet through a transformer or similar device.
CAT II	Primary electrical circuits in equipment connected to an AC electrical outlet by a power cord (portable tools, household appliances, etc.)
CAT III	Primary electrical circuits of heavy equipment (fixed installations) connected directly to the distribution panel, and feeders from the distribution panel to outlets.
CAT IV	The circuit from the service drop to the service entrance, and to the power meter and primary overcurrent protection device (distribution panel).

Higher-numbered categories correspond to electrical environments with greater momentary energy. So a measurement device designed for CAT III environments can endure greater momentary energy than a device designed for CAT II.

Using a measurement product in an environment designated with a higher-numbered category than that for which the product is rated could result in a severe accident, and must be carefully avoided.

Never use a CAT I measuring product in CAT II, III, or IV environments.

The measurement categories comply with the Overvoltage Categories of the IEC60664 Standards.

---

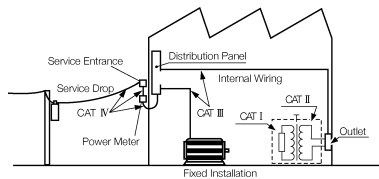

## Notes on Use



Follow these precautions to ensure safe operation and to obtain the full benefits of the various functions.

### DANGER

- Before using the product the first time, verify that it operates normally to ensure that no damage occurred during storage or shipping. If you find any damage, contact your dealer or Hioki representative.
- When conductors being measured carry in excess of the safe voltage level (SELV-E) and not more than 300 V, to prevent short circuits and electric shock while the clamp sensor jaw is open, make sure that conductors to be measured are insulated with material conforming to (1) Overvoltage Category III, (2) Pollution Degree 2, and (3) Basic Insulation Requirements for Working Voltages of 300 V. Refer to the following standards regarding the meanings of underlined terms.  
IEC61010-1  
IEC61010-2-031  
IEC61010-2-032

**⚠ DANGER** 

---

- Do not use clamp testers on bare conductors. When the clamp sensor jaw is open, there is a risk of short-circuits and accidents that could result in injury or death.
  - Use clamp testers only on power lines up to AC 300 V rms, to avoid short-circuits and accidents that could result in injury or death.
  - This product should only be connected to the secondary side of a breaker, so the breaker can prevent an accident if a short circuit occurs. Connections should never be made to the primary side of a breaker, because unrestricted current flow could cause a serious accident if a short circuit occurs.
  - Use only the specified Model 9445-02 (SA10-0910N, SINO-AMERICAN) or 9445-03 (for EU) (SA10-0910G, SINO-AMERICAN). AC adapter input voltage range is 100 to 240 V AC (with  $\pm$  10% stability) at 50/60 Hz. To avoid electrical hazards and damage to the product, do not apply voltage outside of this range.
-

---

 **WARNING**

- To avoid electric shock, do not allow the product to get wet, and do not use it when your hands are wet.
  - To avoid electric shock when measuring live lines, wear appropriate protective gear, such as insulated rubber gloves, boots and a safety helmet.
  - To avoid electric shock when measuring the ground conductor on a transformer Class 2 connection site, be careful not to approach high voltage devices or conductors. Also, if close to high voltage charging devices or if measurement is otherwise difficult, first change the route of the grounding wire.
  - To avoid electric shock when replacing the batteries, first disconnect the clamp portion from the object to be measured. Also, before using the product after replacing the batteries, replace the cover and screw.
  - When replacing the batteries, be sure to insert them with the correct polarity. Otherwise, poor performance or damage from battery leakage could result.
  - To avoid the possibility of explosion, do not short circuit, disassemble or incinerate batteries.
  - Handle and dispose of batteries in accordance with local regulations.
-

**CAUTION**

- This is a precision instrument: do not clamp any foreign objects in the end of the clamp sensor, or insert anything in the clamp sensor gap.
- To avoid damage to the product, protect it from vibration or shock during transport and handling, and be especially careful to avoid dropping. Do not exert excessive pressure on the clamp sensor or attempt to wedge the sensor into a tight spot for measurement.
- To avoid damage to the product, do not exceed the maximum input current rating, which depends on the frequency of the current being measured (see following Figure).

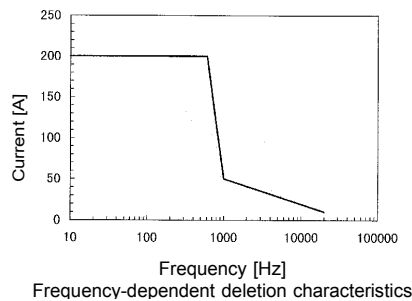

---

**⚠ CAUTION**

- Do not use the unit if the battery is exhausted (when the  mark lights in the display area). Be sure to replace the exhausted battery with a new one.
  - When replacing the battery, make sure that the metal battery snap fitting is firmly connected. If the metal fitting is loose, adjust it and recheck the connection. If it isn't connected securely, the power may not be turned on, and a power may be turned off during the use.
  - Adjustments and repairs should be made only by technically qualified personnel.
  - For the inside memory protection, make sure the power is turned off before connecting or disconnecting the AC adapter.
  - This product is designed for indoor use, and operates reliably from 0°C to 40°C.
  - Do not store or use the product where it could be exposed to direct sunlight, high temperature or humidity, or condensation. Under such conditions, the product may be damaged and insulation may deteriorate so that it no longer meets specifications.
-

- NOTE**
- For circuits which carry several superimposed currents, correct measurements may not be obtained.
  - Accurate measurement may be impossible in the presence of strong magnetic fields, such as near transformers and high-current conductors, or in the presence of strong electromagnetic fields such as near radio transmitters.



---

## Chapter Summary

This manual consists of the following chapters. "Introduction", "Safety Notes", "Notes on Use" describe precautions on use, overview, and features of this unit.

Be sure to read them all. Next, check Chapter 1 to 3 and the unit to confirm your understanding of the function.

### Chapter 1 Product Outline

Explains the parts and functions of the unit.

### Chapter 2 Measurement Procedure

Explains how to use the 3283 for measurement.

### Chapter 3 Battery Replacement

Explains how to replace the battery used to power the 3283.

### Chapter 4 Attaching the Hand Strap

Explains how to attach the hand strap, for easy handling of the unit in the field.

### Chapter 5 Specifications

Lists the specifications of the 3283 CLAMP ON LEAK HITESTER.

### Chapter 6 Troubleshooting

Describes points to check before requesting service.

### Chapter 7 Service

Explains how to get the unit serviced.

---

---

# Chapter 1

## Product Outline

---

### 1.1 Product Outline

The 3283 CLAMP ON LEAK HiTESTER is designed for wide-range measurement on live circuits, from very small leak currents up to load currents of 200 amperes. The clamp part is made of material with high magnetic permeability, to minimize adverse effects caused by external magnetic fields, and to reduce tolerances due to the position of the measured conductor.

---

### 1.2 Features

- High-sensitivity range with 10 mA full-scale point  
Allows accurate measurement even of minute leak currents (resolution 10  $\mu$  A).
- Wide measurement range  
Five range settings from 10 mA to 200 A make the 3283 suitable for many applications.
- Microprocessor-controlled functions  
In spite of the compact dimensions of the unit, versatile functions such as SLOW and MAX/MIN are made possible by the built-in microprocessor.

- True rms indication  
The true rms conversion circuit delivers accurate results not affected by leak current distortion.
- Filtering  
The widespread use of switching power supplies and equipment incorporating inverter technology frequently causes harmonics to be superimposed in the leak current waveform. The filter in the 3283 allows two kinds of measurement, for leak current caused by insulation faults and for leak currents including harmonics.
- Output jack  
The output jack allows easy connection to a level recorder or other equipment (level recorder output: DC, waveform output: AC).
- Unaffected by external magnetic fields and conductor position  
The clamp sensor and magnetic shield are made of material with high magnetic permeability, allowing precise measurement also in the vicinity of transformers, electric motors and other sources of magnetic fields. Since the influence of the conductor position on the measurement result is negligible, residual current characteristics are not a problem even when using the unit as a zero-phase transformer.
- Low power consumption  
Power consumption is less than 100 mV A, allowing the unit to operate continuously for up to 40 hours on a single 6F22 (006P) battery.

- **Dual power supply design**  
The unit can be powered using the optional 9445-02 AC adapter (SA10-0910N, SINO-AMERICAN), 9445-03 AC adapter (for EU) (SA10-0910G, SINO-AMERICAN), or from a battery.

### 1.3 Parts and Functions

Top and Side View

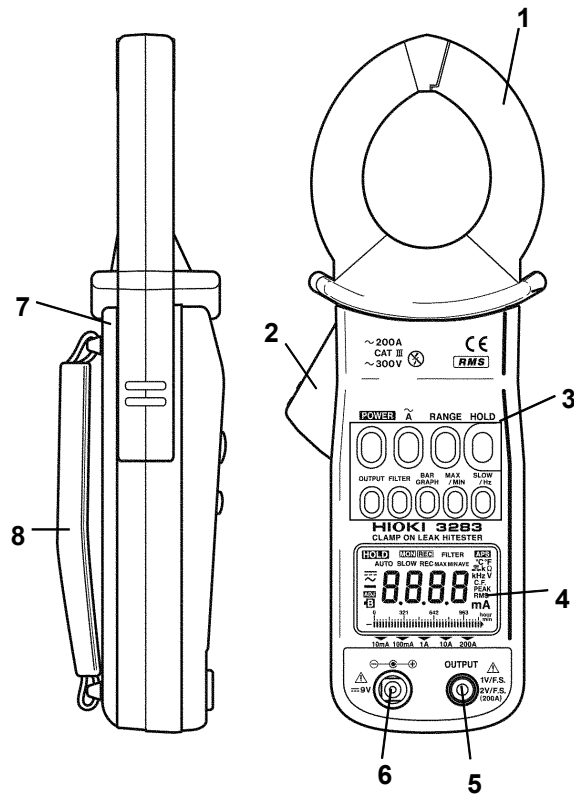

1. Clamp sensor
2. Operation lever
3. Key switches
4. Display (LCD)
5. Output jack
6. AC adapter jack
7. Rear cover
8. Hand Strap

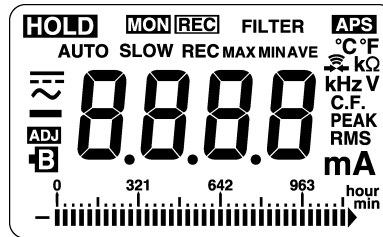

~	AC
<b>AUTO</b>	Auto-range
<b>SLOW</b>	Update display once every 3 seconds
<b>REC</b>	Record function
<b>MAX</b>	Maximum value
<b>MIN</b>	Minimum value
<b>AVE</b>	Average value = (maximum value + minimum value/2)
<b>min</b>	1 minute/segment (bar graph)
<b>hour</b>	1 hour/segment (bar graph)
<b>HOLD</b>	Data hold function
<b>APS</b>	Auto power off function
<b>MON</b>	Waveform output (AC) is active
<b>REC</b>	Recording output (DC) is active
<b>FILTER</b>	Filter function is active
<b>Hz</b>	Frequency
<b>A, mA</b>	current
<b>RMS</b>	True root mean square value
▶	Input over (bar graph)
⊖	Battery low warning

---

## Chapter 2 Measurement Procedure

---

### 2.1 Preparations

1. Remove the rear cover and insert the battery.  
(Refer to "Chapter 3 Battery Replacement".)
2. Press the **POWER** key to turn the unit on.  
Verify that all segments of the display light up briefly. Then the model name is shown, and the bar graph indicates the battery condition for a second.

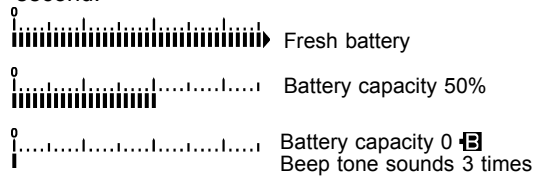

3. The AC current measurement mode is activated

#### **【 Battery low voltage power-off 】**

After the **Lo** mark lights and battery voltage drops below a certain level, for the inside memory protection, the power goes off automatically. When this occurs, **bAtt** and **Lo** are displayed.

When power goes off after display of these marks, replace the exhausted battery with a new one.

## 2.2 Leak Current Measurement $\hat{A}$

1. Press the  $\hat{A}$  key.
2. Clamp the tester on the conductor, so that the conductor passes through the center of the clamp sensor. For measurement of grounded leads, clamp the tester on one lead only (see a). For overall measurements, clamp the tester on the entire circuit path (see B).

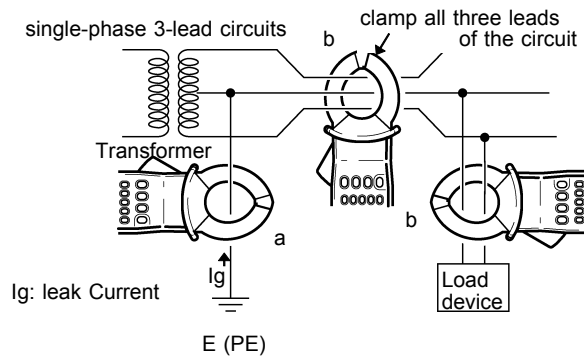

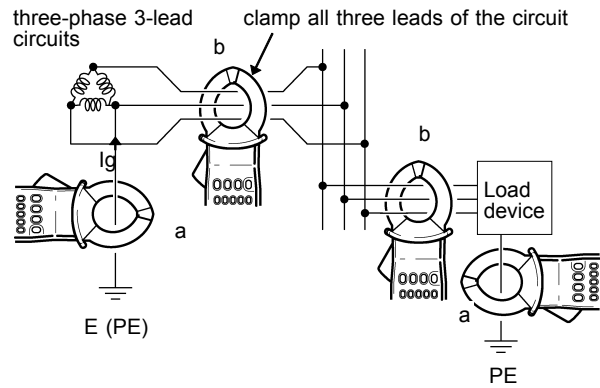
**NOTE**

- For measurement of single-phase 2-lead circuits, clamp both leads of the circuit.
- For measurement of three-phase 4-lead circuits, clamp all four leads of the circuit. If this is not possible, the measurement can also be carried out on the ground lead of the equipment.

3. The effective value (**RMS**) of the leak current is shown on the digital display. The selected current range is shown at the bottom of the display.

**NOTE**

- Do not input current that exceeds the maximum continuous input of the electric current range.
- Measurement may not be accurate in the cases below.
  - (1) When there is large current (of about 100 A) flowing through a nearby electric line
  - (2) When using the 3283 to measure special waveforms, such as those on the secondary side of an inverter
- Note that a value of several tens of amperes may be displayed when opening or closing the clamp sensor, or when changing the electric current range. This is not an error. It may take some time for the display to return to zero. However, starting measurement before the display returns to zero will not affect measurement.

### 【Checking for insulation faults】

Normally, for a E (PE) grounding installation of a transformer, the measurement will first be made to check for overall circuit leak current in the ground lead (a). Current changes can be used to diagnose the leak current condition. When leak current has been detected, the measurement should proceed from the power source towards the load, using overall measurement.

1. If an insulation fault in the wiring has occurred at position A in the illustration, leak current will be detected at position b using overall measurement, but not at position b'.
2. If an insulation fault in the load equipment has occurred at position B in the illustration, leak current will be detected at position c using overall measurement, but not at position c'.
3. For detection of intermittent leak current conditions (such as only when a certain piece of equipment is operating), the use of a level recorder will be helpful.

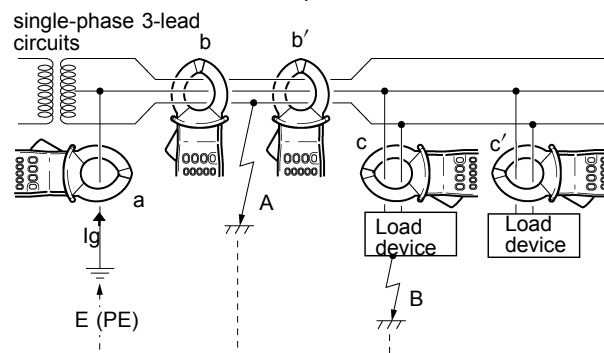

Chapter 2 Measurement Procedure

**[Range switching]**

Each push of the **RANGE** key switches the range in the order 10 mA → 100 mA → 1 A → 10 A → 200 A → **AUTO**.

**[Changing the display characteristics SLOW]**

If the indicated current value fluctuates rapidly and is hard to read, you can select a slower update rate (once every 3 seconds) by pressing the **SLOW/Hz** key.

The key cycles through the following modes:

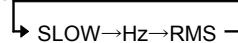

The update speed cannot be changed for frequency display.

**[Bar graph display BAR GRAPH]**

The current range display can be switched to bar graph operation. The bar graph shows the rms value of the measured current.

The bar graph display refresh rate is "FAST" (4 times per second).

1. Press the **BAR GRAPH** key.
2. The current range display is switched to bar graph operation.

Each push of the **BAR GRAPH** key toggles between the following modes:

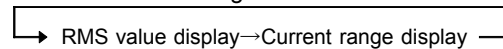

The flashing segment indicates the full-scale position.

**【Frequency (Hz) display】**

1. While the display is switched to **SLOW** mode, press the **SLOW/Hz** key.
2. The frequency of the measured current is displayed.  
If there is no input, and input is lower than 30Hz, "----" is shown.  
Each push of the **SLOW/Hz** key cycles through the following modes:

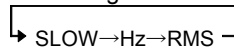

- NOTE**
- There is no frequency output function.
  - Enable the filter function (see 2.3) when conducting measurement in the cases below.
    - (1) When meaningless data is displayed due to noise
    - (2) When using the 3283 to measure special waveforms, such as those on the secondary side of an inverter
  - The 3283 may not be able to perform measurement in the cases below.
    - (1) When using input current that is 1/10 or less of the full electric current range
    - (2) When measuring high frequencies with the filter function enabled
  - The range display (**AUTO** and Bar graph) indicates the electric current range.

**【Load current measurement】**

Be sure to clamp only one lead of the conductor.

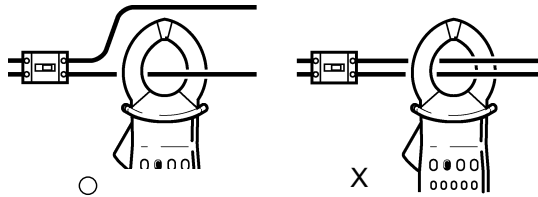

- NOTE**
- The frequency of special waveforms such as at the secondary side of an inverter may not be indicated correctly.
  - Depending on the magnitude and frequency of the input current, resonances may be heard from the clamp jaw. This does not affect the measurement.
  - When the size of input current is unknown, begin measurement with the 200 A range (filter function is invalid) selected .
  - Do not input a current which exceeds the maximum continuous input rating of the current range.

## 2.3 Filter Function FILTER

The widespread use of switching power supplies and equipment incorporating inverter technology can cause harmonics to be superimposed on the leak current waveform.

1. Press the **FILTER** key. The **FILTER** indication appears. The integrated low-pass filter is now active, cutting off unwanted higher-frequency components.
2. Pressing the **FILTER** key once more turns the low-pass filter off, allowing measurement of leak current including any high-frequency components. The **FILTER** indication disappears.

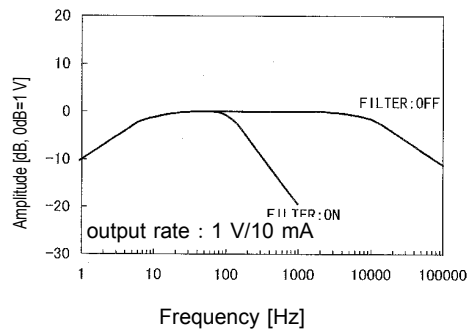

MON output frequency bandwidth (example: 10 mA range)

**NOTE** The effect of the filter function is reflected in numeric data output and waveform output.

## 2.4 Data Hold Function **HOLD**

This function allows freezing the display at any desired point for easy reading.

1. Press the **HOLD** key. The **HOLD** indication appears on the display and the digital display value is maintained.

To cancel the data hold function, press the **HOLD** key again.

---

## 2.5 Recording Function **REC**

The recording function can be used to display the maximum display value, minimum display value, maximum/minimum average, and the instantaneous value.

1. Press the **RANGE** key to select the current measurement range.
2. Press the **MAX/MIN** key while measuring current with the conductor clamped. The **REC** indication flashes and the maximum, minimum, or average value for the period starting when the key was pressed to the present point can be displayed. The instantaneous value can also be displayed. Only one of these values can be shown at any one time, but the other values are kept in memory.

**NOTE** Pressing the **MAX/MIN** key during auto-ranging (**AUTO**) fixes the range at the current setting.

- 
3. During measurement, the **MAX/MIN** key can be used to select the value that should be shown.

**MAX:** Maximum value is shown.

**MIN:** Minimum value is shown.

**AVE:** Average value is shown = (maximum value + minimum value)/2

If none of the **MAX**, **MIN**, or **AVE** indicators is shown, the display shows the instantaneous value.

4. Pressing the **HOLD** key will stop the recording function. The **HOLD** indication appears and the **REC** indication stops flashing. By pressing the **MAX/MIN** key in this condition, the **MAX**, **MIN**, and **AVE** values stored in the internal memory can be called up on the display, as follows.

→ MAX→MIN→AVE→instantaneous value —  
(no indication)

While **HOLD** is shown, the elapsed time is not incremented. Also if the clamp sensor is removed from the conductor for easier reading, the minimum value will not return to zero. Pressing the **HOLD** key once more causes the **HOLD** indication to go out. The recording function resumes, and **REC** flashes again.

- NOTE**
- Momentary power loss and power surges cannot be detected.
  - When the unit is turned off, accumulated data are lost.
  - The maximum recording duration depends on the remaining battery capacity.
  - The lowest possible frequency that can be displayed is 30.0 Hz.
  - If the measurement object was clamped after activating the recording function, the minimum value is always zero. To prevent this, clamp the conductor first and then press the **MAX/MIN** key to activate the recording function.
  - If the clamp sensor is removed from the measurement object while the recording function is active, the minimum value will become zero. To prevent this, press the **HOLD** key before removing the clamp sensor.
  - To turn off the recording function, press the **⏏** key. The maximum value, minimum value, and average value are cleared.

**[Bar graph indication BAR GRAPH]**

The bar graph display can be changed. It is also possible to display the current range, effective (rms) value of the measured current, and the elapsed time (hours and minutes).

1. Press the **[BAR GRAPH]** key.
2. The current range display switches to bar graph indication.

Each push of the **[BAR GRAPH]** key cycles through the following modes:

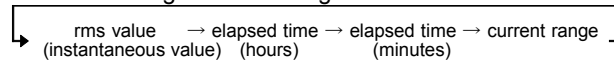

When the elapsed time display is activated, the bar graph segments flash and the elapsed time from the point when the **[MAX/MIN]** key was pressed is displayed.

When "min" is shown in the right-hand corner of the bar graph, each segment of the bar graph corresponds to one minute. Every time one minute elapses, one segment of the flashing bar graph goes on. When all segments on the bar graph go on, the elapsed time is 30 minutes.

When the elapsed time exceeds 30 minutes, one segment of the flashing bar graph goes off every time one minute elapses.

When the segments left of a flashing segment remain on: the number of "on" segments represents the elapsed time (0 to 29). The illustration below shows when 20 minutes have elapsed:



When the segments right of a flashing segment remain on: the number of "off" segments (+30) represents the elapsed time (30 to 59). The illustration below shows when 50 minutes have elapsed:

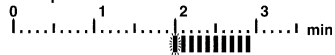

When "hour" is selected, one segment corresponds to one hour, and the maximum length of time that can be displayed is 59 hours.

The illustration below shows indication when 1 hour 40 minutes have elapsed.

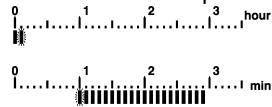

---

## 2.6 Auto Power-Off Function **APS**

When **APS** is displayed, the auto power-off function is active.

If no key is pressed for about 10 minutes, the unit turns itself off automatically.

Immediately before turning off, the **APS** indication flashes and a beep tone is heard for about 30 seconds.

Pressing any key except the **POWER** key will extend the powered state for another 10 minutes.

To disable the auto power-off function, hold down the **HOLD** key while turning the unit on by pressing the **POWER** key. The **APS** indication then is not shown.

While using the recording function or the output function of the unit, auto power-off is disabled.

---

## 2.7 Battery Low Warning **B**

When this indication appears, the battery is exhausted and correct measurement is not assured. Replace the battery as early as possible.

Refer to "Chapter 2 [Battery low voltage power-off]".

---

## 2.8 Beep Tone

To disable the beep tone, hold down the **RANGE** key while turning the unit on by pressing the **POWER** key.

---

## 2.9 Fast Mode

The display update rate can be set to 4 times per second. This is useful for example to measure load currents with frequent variations and similar applications.

1. Press the **[A]** key twice in succession. The indication "F" is briefly shown, and the unit switches to fast mode. From now on, the indication "F" will appear every time the **[A]** key is pressed. To cancel the fast mode, press the **[A]** key twice in succession.

**NOTE** If SLOW is selected while the unit is in fast mode, the display update rate will be normal (2 times per second).

### **[ Example to measure load currents with frequent variations ]**

1. Press the **[A]** key twice in succession to activate fast mode.
2. Press the **[RANGE]** key to set the current range to a fixed setting.  
When the drive current is unknown, begin measurement with the 200 A range selected
3. Use the recording function to record the maximum value, for easier reading.

**NOTE** Circuit time constant 200 ms MAX.



## 2.10 Output Function OUTPUT

The output type is indicated by the **REC** (recording output, DC) or **MON** (waveform output, AC) indication.

An output signal corresponding to the measured value can be obtained from the unit. The output voltage (AC/DC) normally is 1 V for the full-scale count (1000). In the 200 A range, the output voltage (AC/DC) is 2 V for the full-scale count (2000).

1. Press the **RANGE** key to set the current range to a fixed setting.
2. Press the **OUTPUT** key so that the **REC** indication appears. The output function is now active.  
Auto power-off is disabled. (The **APS** indication goes out.)

Each push of the **OUTPUT** key cycles through the following modes:

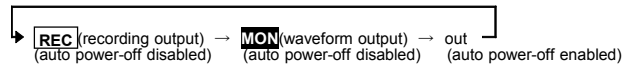

**【Output rate】**

**MON** (waveform output : AC)  
**REC** (recording output : DC)

Current Range	Output rate	Accuracy	Crest Factor
10 mA	AC/DC 1 V/10 mA	AC/DC: ±3.0% rdg. ±10 mV (40Hz to 2 kHz)	2.5 or less
100 mA	AC/DC 1 V/100 mA		
1 A	AC/DC 1 V/1 A		
10 A	AC/DC 1 V/10 A		
200 A	AC/DC 2 V/200 A		1.5 or less

**【Output response】**

REC	MON
(Circuit time constant) 200 ms or less	frequency bandwidth (-3 dB) 5 Hz to 15 kHz

- 
- NOTE**
- To use the output function, be sure to push the **OUTPUT** key so that either **REC** or **MON** is shown.
  - There is no frequency output function.
  - The filter function can be used to cut unwanted high-frequency components.
  - If the **OUTPUT** key is pressed while auto-range (**AUTO**) is enabled, the range is fixed at the current setting (**AUTO** indication goes out).
  - For connection to a level recorder, use the separately available 9094 OUTPUT CORD.
  - Use a high-impedance input device (e.g., recorder) for receiving output. (We recommend a device with input impedance of at least 100 k $\Omega$ .)

#### **【Using AC Adapter】**

For long-term recordings, use the AC adapter (option).

- NOTE**
- Even if the AC adapter is connected, if the battery is exhausted (the **B** mark lights), the power may turn off in order to preserve the data in the internal memory. To continue using the instrument, replace the depleted battery with a new battery, or remove the battery completely.
  - When the AC adapter is used and there is a high amount of noise in the power line, the display may show several counts or noise may be present in the output. In such a case, connect the ground terminal of the level recorder or the **L** side of the input to ground.
  - Pressing the **HOLD** key does not hold the output signal.
  - Please note that the output signal is available also when **REC** and **MON** indications are out, but the auto power-off function is enabled.

---

## Chapter 3 Battery Replacement

---

**CAUTION**

Do not fix the back casing screws too tightly.  
The torque about  $0.5\text{N}\cdot\text{m}$  is recommended.

---

1. Remove the two fastening screws of the rear cover, using a Phillips screwdriver.
2. Remove the rear cover.
3. Remove the old battery without pulling the codes of the snap.
4. Securely connect the battery to the battery snap.
5. Replace the rear cover and tighten the fastening screws.

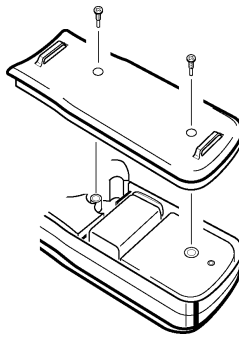
**NOTE**

Fix the terminals of battery snap and battery exactly.

---

## Chapter 4 Attaching the Hand Strap

---

Explains how to attach the hand strap, for easy handling of the unit in the field.

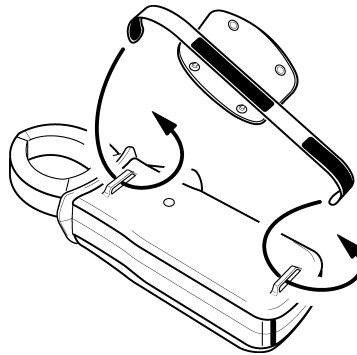

---

## Chapter 5 Specifications

---

### 5.1 Measurement Specifications

- **Temperature and humidity for guaranteed accuracy:**  $23^{\circ}\text{C} \pm 5^{\circ}\text{C}$  ( $73 \pm 9$ ), 80% RH or less
- **Guaranteed accuracy period:** 1 year, or opening and closing of the Clamp Sensor 10,000 times, whichever comes first

### 5.1.1 AC current Arms(true rms indication)

Current Range (Accuracy Range)	Resolution	Accuracy (NOTE) $\pm$ (%rdg.+dgt.)	Maximum permitted current
10 mA (1.00 to 10.00 mA)	0.01 mA	45 to 66 Hz: $\pm$ (1.0%+5) 40 to 45 66 to 2 kHz: $\pm$ (2.0%+5)	20 Arms AC, continuous (see fig. A)
100 mA (10.0 to 100.0 mA)	0.1 mA		
1 A (0.100 to 1.000 A)	0.001 A		
10 A (1.00 to 10.00 A)	0.01 A		
200 A (10.0 to 200.0 A)	0.1 A	45 to 66 Hz: $\pm$ (1.5%+5) 40 to 45 66 to 2 kHz: $\pm$ (2.0%+5)	200 Arms AC, continuous (see fig. A)

- NOTE**
- Accuracy with filter function disabled.
  - When the filter function is enabled.
    - 10 mA Range to 10 A Range:  
50 Hz to 60 Hz (1.5%+5)
    - 200 A Range: 50 Hz to 60 Hz (2.0%+5)

Effect of conductor position	within $\pm 0.1\%$ (in any direction from clamp sensor center) 100 A MAX: within $\pm 0.5\%$
Effect of external magnetic fields	AC 400 A/m corresponds to 5 mA, max. 7.5 mA
Maximum rated voltage to earth	max. 300 V rms AC (insulated conductor)

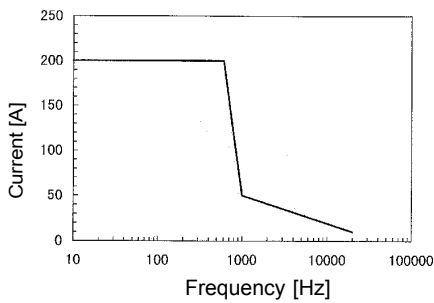

Fig.A Frequency-dependent deletion characteristics

### 5.1.2 Frequency Hz

Frequency Range (Accuracy Range)	Resolution	Accuracy $\pm$ (%rdg.+dgt.)
100 Hz (30.0 to 99.9 Hz)	0.1 Hz	$\pm$ (0.3%+1)
1000 Hz (95 to 1000 Hz)	1 Hz	$\pm$ (1.0%+1)

**NOTE** The frequency range is automatically specified.

---

## 5.2 General Specifications

---

### • Functions

Recording	Maximum (MAX), minimum (MIN), average (AVE) value display selectable for AC current and frequency measurement
Data hold	Data hold function
Auto power-off	Automatic shutdown after $10.5 \pm 1$ minutes. Beep tone warning. Extension and disabling possible.
Battery low voltage power-off	When the battery voltage falls below a certain level, the function shuts down the unit to prevent malfunctions.
Beep tone	ON/OFF
<hr/>	
<b>• Display</b>	
Display	LCD panel
Digital indication	2000 counts
Bar graph indication	35 segments Current range display or rms display selectable
Over-range indication	"O.L." ► (bar graph) Over range warning sound (buzzer)
Battery low warning	
Battery low voltage power-off	"bAtt Lo" (7 segments used) Power turned off after display

---

### Chapter 5 Specifications

Data hold indication	<b>HOLD</b>
Auto power-off indication	<b>APS</b>
Filter function	Cutoff frequency 180 Hz $\pm$ 30 Hz (-3 dB)
Display update rate	Digital indication NORMAL: 500 ms $\pm$ 25 ms (approx. 2 times/second) SLOW : 3 s $\pm$ 0.15 s (approx. 1 time/3seconds) FAST : 250 ms $\pm$ 12.5 ms (approx. 4 times/second) Bar graph indication FAST only
Display response time	2.2 s max.
Range switching	Auto range, manual (fixed) range (selectable). Frequency measurement with auto-range only.
Output function	REC (recording output), MON (waveform output) (selectable)
Output rate	REC : 1 V DC at full-scale point (In the 200 A range only, 2 V DC/f.s.) MON : 1 V AC at full-scale point (In the 200 A range only, 2 V AC/f.s.)
Output Accuracy	$\pm$ 3.0%rdg. $\pm$ 10 mV (40 to 2 kHz)
Output response	REC (DC) : circuit time constant 200 ms max. MON (AC) : frequency bandwidth (-3 dB) 5 Hz to 15 kHz
Output impedance	200 $\Omega$ max.

**Chapter 5 Specifications**

Circuit dynamic characteristics (crest factor)	2.5 max. (1.5 for 200 A range)
Withstand voltage	Chassis - clamp core: 3536 Vrms AC for 15 seconds
Insulation resistance	Clamp core - circuitry: 630 kilohms min.
Location for use	Indoor, altitude up to 2000 m
Applicable standards	<p><b>Safety:</b> EN 61010-1:2001 Voltage input: Pollution level 2, Measurement categories III (expected transient overvoltage: 4000 V) EN 61010-2-032:2002 Type B current sensor EN 60529:1991 IP40 (protected against access to hazardous parts with a wire)</p> <p><b>EMC:</b> EN 61326:1997+A1:1998+A2:2001+A3:2003 EN 61000-3-2:2000 EN 61000-3-3:1995+A1:2001</p>
Maximum conductor diameter for measurement	φ40 mm max.
Operating temperature and humidity range	0 to 40°C, 80%RH or less (no condensation)
Temperature characteristics	In 0 to 40°C range: 0.05 x accuracy specifications/°C
Storage temperature range	-10 to 50°C (no condensation)

---

**Chapter 5 Specifications**

---

Power source	One 6F22 (006P) 9 V battery or 9445-02 AC ADAPTER (SA10-0910N, SINO-AMERICAN) or 9445-03 AC ADAPTER (EU) (SA10- 0910G, SINO-AMERICAN) (option)
Maximum power consumption	100 mVA
Battery life	approx. 40 hours (continuous, no load)
External dimensions	approx. 62W x 225H x 39D mm
Mass	approx. 400 g
Accessories	9399 CARRYING CASE 1 Hand Strap 1 Battery: 6F22(006P) 1 Instruction manual 1
Options	9445-02 AC ADAPTER (SA10-0910N, SINO-AMERICAN) 9445-03 AC ADAPTER (EU) (SA10-0910G, SINO-AMERICAN) 9094 OUTPUT CORD



---

---

## Chapter 6 Troubleshooting

---

If the unit seems not to be working normally, check the following points first before requesting service.

Problem	Cause	Action
● Problems related to the power supply		
<ul style="list-style-type: none"> <li>• Power will not turn on</li> <li>• Power shuts off during operation</li> </ul>	The battery may be low or depleted	Replace it with a new battery
	The battery snap terminal may be deformed, causing contact failure	Remove the battery, then use radio pliers to straighten the battery snap terminal
	When the AC adapter is used, power is only supplied through the AC adapter	When using the battery, disconnect the AC adapter. Insert the AC adapter into the AC outlet
<ul style="list-style-type: none"> <li>•  lights</li> <li>•  lights, followed by immediate power shutdown</li> </ul>	The battery may be low or depleted	Replace it with a new battery

Problem	Cause	Action
• Problems related to display		
• An error between E.001 and E.005 or E.100 is displayed.	Internal memory may be damaged	Request repair
• Problems related to the clamp sensor		
• The clamp sensor generates a sound during measurement	When large current or high-frequency current is measured, resonance may occur, generating a sound	Reclamp the conductor. Measure micro-current or low-frequency current to determine whether a sound is generated

Problem	Cause	Action
● Problems related to output function		
<ul style="list-style-type: none"> <li>• The output rate differs from the specification</li> <li>• The output is too low</li> </ul>	The 200 A range is used	Check the electric current range. Unlike other ranges, the full scale of the 200 A range is 2 V/fs
	The input impedance of the device used to receive output is too low	Check the input impedance of the device used to receive output. We recommend input impedance of at least 100 kΩ
	MON output is used for measurement at high frequency	The guaranteed range of accuracy is 40 Hz to 2 kHz. The specified frequency band of 5 Hz to 15 Hz is a -3 dB band. At 15 kHz, the amplitude is reduced to approximately 70%

---

## Chapter 7 Service

---

- To clean the product, wipe it gently with a soft cloth moistened with water or mild detergent. Never use solvents such as benzene, alcohol, acetone, ether, ketones, thinners or gasoline, as they can deform and discolor the case.
- The minimum stocking period for replacement parts is five years after end of production.
- For information regarding service, please contact your dealer or the nearest HIOKI representative.
- If the unit is not functioning properly, check the battery. If a problem is found, contact your dealer or HIOKI representative. Pack the unit carefully so that it will not be damaged during transport, and write a detailed description of the problem. HIOKI cannot bear any responsibility for damage that occurs during shipment.

**HIOKI**

**DECLARATION OF CONFORMITY**

Manufacturer's Name: HIOKI E.E. CORPORATION  
Manufacturer's Address: 81 Koizumi, Ueda, Nagano 386-1192, Japan  
Product Name: CLAMP ON LEAK HITESTER  
Model Number: 3283  
Options: 9094 OUTPUT CORD  
9445-03 AC ADAPTER (SA10-0910G,  
SINO-AMERICAN)

The above mentioned products conform to the following product specifications:

Safety: EN61010-1:2001  
EN61010-2-032:2002  
EMC: EN61326:1997+A1:1998+A2:2001+A3:2003  
Class B equipment  
Minimum immunity test requirement  
Portable test, measuring and monitoring equipment  
used in low-voltage distribution systems  
EN61000-3-2:2000  
EN61000-3-3:1995+A1:2001

Supplementary Information:

The products herewith comply with the requirements of the Low Voltage Directive 73/23/EEC and the EMC Directive 89/336/EEC.

HIOKI E.E. CORPORATION

26 September 2006

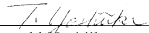
  
Tatsuyoshi Yoshiike  
President

3283A999-05

**HIOKI 3283 CLAMP ON LEAK HITESTER**  
Instruction Manual

Publication date: September 2006 Revised edition 13

Edited and published by HIOKI E.E. CORPORATION

Technical Sales Support Section

All inquiries to International Sales and Marketing  
Department

81 Koizumi, Ueda, Nagano, 386-1192, Japan

TEL: +81-268-28-0562 / FAX: +81-268-28-0568

E-mail: [os-com@hioki.co.jp](mailto:os-com@hioki.co.jp)

URL <http://www.hioki.co.jp/>

- All reasonable care has been taken in the production of this manual, but if you find any points which are unclear or in error, please contact your supplier or the International Sales and Marketing Department at HIOKI headquarters.
  - In the interests of product development, the contents of this manual are subject to revision without prior notice.
  - Unauthorized reproduction or copying of this manual is prohibited.
-