

Copyright© Chauvin Arnoux®, Inc. d.b.a. AEMC® Instruments. All rights reserved.

No part of this documentation may be reproduced in any form or by any means (including electronic storage and retrieval or translation into any other language) without prior agreement and written consent from Chauvin Arnoux®, Inc., as governed by United States and International copyright laws.

Chauvin Arnoux®, Inc. d.b.a. AEMC® Instruments
15 Faraday Drive • Dover, NH 03820 USA
Phone: (603) 749-6434 or (800) 343-1391 • Fax: (603) 742-2346

This documentation is provided **as is**, without warranty of any kind, express, implied, or otherwise. Chauvin Arnoux®, Inc. has made every reasonable effort to ensure that this documentation is accurate; but does not warrant the accuracy or completeness of the text, graphics, or other information contained in this documentation. Chauvin Arnoux®, Inc. shall not be liable for any damages, special, indirect, incidental, or inconsequential; including (but not limited to) physical, emotional or monetary damages due to lost revenues or lost profits that may result from the use of this documentation, whether or not the user of the documentation has been advised of the possibility of such damages.

Statement of Compliance

Chauvin Arnoux®, Inc. d.b.a. AEMC® Instruments certifies that this instrument has been calibrated using standards and instruments traceable to international standards.

We guarantee that at the time of shipping your instrument has met the instrument's published specifications.

An NIST traceable certificate may be requested at the time of purchase, or obtained by returning the instrument to our repair and calibration facility, for a nominal charge.

The recommended calibration interval for this instrument is 12 months and begins on the date of receipt by the customer. For recalibration, please use our calibration services. Refer to our repair and calibration section at www.aemc.com/calibration.

Serial #: _____

Catalog #: 2129.84

Model #: 6255

Please fill in the appropriate date as indicated:

Date Received: _____



Date Calibration Due: _____



Chauvin Arnoux®, Inc.
d.b.a AEMC® Instruments
www.aemc.com

TABLE OF CONTENTS

1. INTRODUCTION	7
1.1 INTERNATIONAL ELECTRICAL SYMBOLS.....	7
1.2 DEFINITION OF MEASUREMENT CATEGORIES (CAT)	7
1.3 PRECAUTIONS FOR USE 	7
1.4 BATTERY HANDLING.....	8
1.5 RECEIVING YOUR SHIPMENT	9
1.6 ORDERING INFORMATION.....	9
1.6.1 Accessories.....	9
1.6.2 Replacement Parts	10
2. FEATURES	11
2.1 DESCRIPTION.....	11
2.2 APPLICATIONS.....	11
2.3 KEY FEATURES.....	12
2.4 CONTROL FEATURES	13
2.5 BUTTON FUNCTIONS.....	14
2.6 DISPLAY SYMBOLS	15
3. SPECIFICATIONS	17
3.1 ELECTRICAL	17
3.2 MECHANICAL	18
3.3 DISPLAY.....	18
3.4 ENVIRONMENTAL	18
3.5 SAFETY.....	18
4. OPERATION	19
4.1 QUICK SUMMARY	19
4.2 INSTRUMENT CONFIGURATION (SET-UP MODE).....	20
4.2.1 Program Menu Tree	20
4.2.2 Program the 9-Pin Interface Port (rS).....	21
4.2.3 Setting the Buzzer Level (bUZZ).....	22
4.2.4 Reading the Internal Serial Number (EdSn).....	22
4.2.5 Reading the Internal Software Version (EdPP).....	22
4.2.6 Setting the Language used for Printing Reports (LANg).....	22
4.2.7 Setting the Value for the Reference Temperature (trEF).....	23
4.2.8 Selecting Method and Value for Ambient Temperature (tAnb).....	23

4.2.9	Selecting the Metal Type (nEtA)	24
4.2.10	Programming the Alpha Value (ALPH)	24
4.2.11	Selecting Temperature Units (dEg)	24
4.2.12	Setting Alarm Set Point, Direction and Buzzer Level (ALAr)	25
4.2.13	Setting the Display Timeout (LlgH)	25
4.2.14	Clearing the Memory (nEn)	26
4.3	OPERATING PROCEDURE	27
4.3.1	Connections and Readings	27
4.3.2	Test Lead Connection	28
4.3.3	Very Low Resistance	28
4.3.4	Meter Readings	28
4.3.5	Stand-by (ST BY) State	29
4.4	SELECTING THE TEST RANGE	29
4.5	MEASUREMENT MODES	30
4.5.1	Measurement Safety Warnings	30
4.5.2	Inductive Resistance Measurement Mode ()	30
4.5.3	Resistance Measurement Mode ()	31
4.5.4	Low Inductive Resistance Automatic Triggering Measurement Mode	33
4.6	AMBIENT TEMPERATURE COMPENSATION	33
4.6.1	Activating the Compensation Function	36
4.7	ACTIVATING ALARMS	37
5.	MEMORY / PRINTING	38
5.1	MANAGING AND PRINTING THE DATA IN MEMORY	38
5.2	DISPLAYING AND PRINTING STORED MEASUREMENTS	38
5.3	CABLES AND PRINTERS USED WITH THE INTERFACE PORT	40
6.	DATAVIEW®	42
7.	TROUBLESHOOTING	43
7.1	FAULT INDICATORS	43
8.	APPLICATION EXAMPLES	44
8.1	MEASURING WINDING RESISTANCE OF MOTORS AND TRANSFORMERS	44
8.2	MEASURING RESISTANCE ON ELECTRIC MOTORS	44
8.3	BATTERY STRAP MEASUREMENTS	45







9. MAINTENANCE46
9.1 WARNING..... 46
9.2 CLEANING..... 46
9.3 CHARGING THE BATTERY 46
9.4 BATTERY AND FUSE REPLACEMENT 47
9.5 REPAIR AND CALIBRATION 48
9.6 TECHNICAL ASSISTANCE 48
9.7 LIMITED WARRANTY..... 49
 9.7.1 Warranty Repairs..... 49

1. INTRODUCTION

Thank you for purchasing an AEMC® Instruments **Micro-Ohmmeter Model 6255**.

For best results from your instrument and for your safety, read the enclosed operating instructions carefully and comply with the precautions for use. Only qualified and trained operators should use this product.

1.1 INTERNATIONAL ELECTRICAL SYMBOLS

	Signifies that the instrument is protected by double or reinforced insulation.
	Indicates a risk of electric shock. The voltage at the parts marked with this symbol may be dangerous.
	CAUTION - Risk of Danger! Indicates a WARNING . Whenever this symbol is present, the operator must refer to the user manual before operation.
	Battery
	Indicates Important information to acknowledge
	This product complies with the Low Voltage & Electromagnetic Compatibility European directives.

1.2 DEFINITION OF MEASUREMENT CATEGORIES (CAT)

- CAT IV:** Corresponds to measurements performed at primary electrical supply (< 1000 V).
Example: primary overcurrent protection devices, ripple control units, and meters.
- CAT III:** Corresponds to measurements performed in the building installation at the distribution level.
Example: hardwired equipment in fixed installation and circuit breakers.
- CAT II:** Corresponds to measurements performed on circuits directly connected to the electrical distribution system.
Example: measurements on household appliances and portable tools.

1.3 PRECAUTIONS FOR USE

Refer to the following warnings to ensure personnel safety and proper instrument operation.

Failure to observe the safety instructions may result in electric shock, fire, explosion, and destruction of the instrument and of the installations.

- Read the user manual before performing any tests with this instrument.
- Only test de-energized circuits. Never connect to a live circuit.

- When measuring resistance with a high inductive component (transformers, motors, etc.), after ending the measurement the instrument discharges the inductive sample and the warning icon appears for the entire duration. Never disconnect the connection wires before this icon disappears.
- Do not use the instrument in an explosive environment, including poorly ventilated battery rooms and enclosures.
- Ensure the battery is fully charged prior to testing. If unused for several months, charge the battery. (We recommend monthly charging.)
- Use only direct replacements for blown fuses.
- Do not use alcohol or oil based cleaners when cleaning the instrument. Only use soapy water with a damp cloth or sponge.
- Test leads and measuring wires must be in good condition; replace immediately if there is any deterioration (insulation split, burnt, etc.).
- Never exceed the safety values indicated in the specifications.

1.4 BATTERY HANDLING

Your instrument is equipped with a NiMH battery. This technology offers several advantages:

- Long battery charge life for a limited volume and weight.
- Possibility of quickly charging your battery.
- Significantly reduced memory effect: you can charge your battery even if it is not fully discharged.
- Respect for the environment: no pollutant materials such as lead or cadmium, in compliance with the applicable regulations.

After prolonged storage, the battery may be completely discharged. If so, it must be completely charged. Full charging of a completely discharged battery may take several hours.



NOTE: The instrument cannot be used while the battery is charging.



NOTE: At least 5 charge/discharge cycles will be necessary for your battery to recover 95 % of its capacity.

To maximize battery life:

- Only charge your instrument at temperatures between (32 and 104) °F (0 and 40) °C.
- Comply with the conditions of use defined in this user manual.
- Comply with the storage conditions specified in this user manual.

NiMH technology allows a limited number of charge/discharge cycles depending significantly on:

- The conditions of use.
- The charging conditions.

See § 9 for battery replacement instructions.

1.5 RECEIVING YOUR SHIPMENT

Upon receiving your shipment, make sure that the contents are consistent with the packing list. Notify your distributor of any missing items. If the equipment appears to be damaged, file a claim immediately with the carrier and notify your distributor at once, giving a detailed description of any damage. Save the damaged packing container to substantiate your claim.

1.6 ORDERING INFORMATION

Micro-Ohmmeter Model 6255 **Cat. #2129.84**
Includes extra-large tool bag, set of two 10 ft (3 m) Kelvin clips (10 A - Hippo), set of two 10 ft (3 m) Kelvin Probes (1 A - Spring Loaded), RS-232 DB9 F/F 6 ft null modem cable, RS-232 to USB adapter, US 115 V power cord, quick reference guide, NiMH rechargeable 6 V 9000 mAh battery pack, and USB thumb drive supplied with user manual and DataView® software.

1.6.1 Accessories

Kelvin Clips 20 ft (6 m) 10 A-Hippo.....Cat. #2118.70
Kelvin Probes 20 ft (6 m) 1 A Spring Loaded.....Cat. #2118.74
Kelvin Probes 10 ft (3 m) 10 A Spring Loaded.....Cat. #2118.77
Kelvin Probes 20 ft (6 m) 10 A Spring Loaded.....Cat. #2118.78
Kelvin Clips 10 ft (3 m) 1-10 A.....Cat. #2118.79
Kelvin Clips 20 ft (6 m) 1-10 A.....Cat. #2118.80
Kelvin Probes Pistol Grip 10 ft (3 m) 25 A Spring Loaded.....Cat. #2118.84
Kelvin Probes Pistol Grip 20 ft (6 m) 25 A Spring Loaded.....Cat. #2118.85
RTD Temperature ProbeCat. #2129.95
RTD Temperature Probe with 7 ft (2 m) Extension CableCat. #2129.96
Inverter – 12 V_{DC} to 120 V_{AC} 200 W for Vehicle UseCat. #2135.43

1.6.2 Replacement Parts

Kelvin Clips 10 ft (3 m) 10 A-Hippo.....	Cat. #1017.84
Kelvin Probes 10 ft (3 m) 1 A Spring Loaded.....	Cat. #2118.73
Cable - PC RS-232 DB9 F/F 6 ft (1.8 m) Null Modem Cable	Cat. #2119.45
Extra-large Classic Tool Bag	Cat. #2133.73
Battery Pack - Replacement NiMH 6 V 9000 mAh for Models 6240, 6250 and 6255	Cat. #2129.91
Fuse, set of 3, 16 A/250 V, 1 1/4 x 1/4 in (6.3 x 32 mm) fast blow	Cat. #2129.98
Fuse, set of 10, 2 A/250 V, 3/4 x 3/16 in (5 x 20 mm) fast blow	Cat. #2129.99
115 V Power Cord	Cat. #5000.14
Adapter - RS-232 to USB 2.0 Adapter.....	Cat. #5000.60

Order Accessories and Replacement Parts Directly Online
Check our Storefront at www.aemc.com/store for availability

2. FEATURES

2.1 DESCRIPTION

The Micro-ohmmeter Model 6255 performs low resistance measurements from $1\ \mu\Omega$ to $2500\ \Omega$. This easy-to-use instrument measures all inductive or non-inductive resistances with test currents (continuous or pulsed) from 1 mA to 10 A. A built-in thermal switch protects the micro-ohmmeter against overheating on the 10 A range when in continuous use.

The large, easy-to-read liquid crystal display is 2.25 x 4.00 in. It displays the value of resistance, metal type, reference and ambient temperatures (if selected), alarm conditions (if selected), test current and range and test mode (Resistive, Inductive or Auto). You can perform long measurement campaigns (up to 60 minutes) at 10 A_{DC}. Other features include long battery life and fast load charging (measurement stabilization in under 2 seconds).

The Model 6255 employs a four-wire Kelvin configuration, which eliminates test lead resistance for a measurement accuracy of 0.05 %. A built-in circuit filters out AC signals. The instrument provides laboratory-level performance, offering a high precision of 0.05 % with a maximum resolution of $0.1\ \mu\Omega$ over seven ranges from 5 m Ω to 2.5 k Ω .

The Model 6255 is packaged in a sealed case. It provides a rating of IP64 with cover closed (IP53 with cover open) and locking metal measuring terminals. The instrument is primarily a field device, but can also be used in a shop or manufacturing process.

For operator safety and instrument protection, the instrument is fuse protected at the inputs. Two fuses, accessible behind the front panel, protect against stored energy in inductive loads. Enhanced internal circuitry protects against possible inductive kickback when the current is shut off.

2.2 APPLICATIONS

Some of the more popular and most frequent uses of the micro-ohmmeter are in applications for:

- Checking metallic coating resistance, especially in aeronautics
- Ground connections and continuity measurement
- Resistance measurements on motors and transformers
- Contact resistance measurements on breakers and switches
- Component measurement
- Electrical cable resistance measurement
- Mechanical bond tests
- Wire to terminal connections
- Aircraft and rail bonds
- Many other very low resistance samples

2.3 KEY FEATURES

- Measures from 1 $\mu\Omega$ to 2500 Ω
- Test current selection from 1 mA to 10 A
- RTD temperature measurement (optional)
- Automatic or manual temperature compensation
- Two programmable alarms with high or low triggering
- Stores up to 1500 test results
- Selectable Inductive or Resistive test modes
- Operator safety by automatic discharge of residual charge on the equipment under test
- Instantaneous, continuous or multiple test operation
- Selectable metal type (copper, aluminum or other) for temperature compensation
- Internal, rechargeable batteries conduct up to 5000 tests at 10 A
- A built-in battery pack recharger charges the batteries by connecting to the AC line (90 V/264 V, 45 Hz/420 Hz) using a standard line cord
- 4-Wire measurement with automatic compensation of undesirable voltages and lead resistance
- Large multi-function backlit display
- Direct display of the measurement with its units, range, measurement mode, and (if activated) temperature compensation.
- Measurement can be initiated from the front panel or remotely through the 9-pin communication port
- Rugged, sealed case

2.4 CONTROL FEATURES

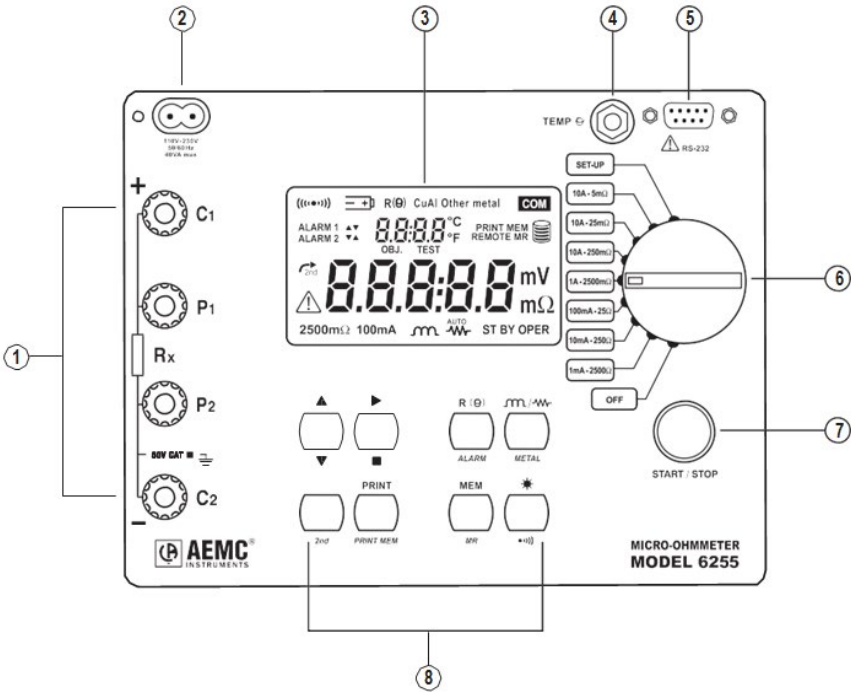















Figure 2-1

1	Kelvin input terminals
2	AC line recharging receptacle
3	Large multi-line backlit liquid crystal display
4	RTD temperature input
5	Communication / remote operation port
6	Range selection switch
7	Test, Start/Stop button
8	Eight program / function buttons

2.5 BUTTON FUNCTIONS

	In SET-UP mode, selects a function or increments a flashing parameter.
	In SET-UP mode, selects a function or decrements a flashing parameter.
	In SET-UP mode, accesses the function to be modified. In Wrap-Around mode, selects the parameter to be modified (from left to right).
	In SET-UP mode, shifts the decimal point and selects the unit.
2nd	Activates the secondary function of a button. The  symbol appears on the left side of the display.
PRINT	Immediate printing of the measurement to a serial printer. If the temperature compensation function has been activated, the calculated result and the temperatures involved are also printed.
PRINT MEM	Retrieves stored data for printing (this function is independent of the setting of the switch) except in the OFF and SET-UP positions.
R (Θ)	Activates or deactivates the temperature compensation function to calculate the resistance measured at a temperature other than ambient measurement temperature.
ALARM	Activates or deactivates the alarms. High or low triggering values are adjusted in SET-UP.
	Selects the desired measurement mode prior to starting one of the following measurements: Inductive mode (continuous test), non-inductive mode (instantaneous test) or non-inductive mode with automatic triggering (multiple tests).
METAL	Selects the metal type for the temperature compensation calculation: Cu, Al, or Other metal.
MEM	Stores the measurement at an address identified by an object number (OBJ) and a test number (TEST). Two presses on this button are required, one to select the location (use the  and  buttons to change the location) and another to store the measurement.
MR	Retrieves stored data (this function is independent of the selector setting of the switch) except for the OFF and SET-UP positions. Data is viewed using the  and  buttons. The R (Θ) ,  , and ALARM buttons can be used.
	Turns the display backlight ON or OFF.
	Activates or deactivates the buzzer and adjusts the sound level.

2.6 DISPLAY SYMBOLS

The display incorporates two lines of characters to display test results, as well as a library of symbols to assist the operator in determining conditions at a glance. The symbols that can appear are shown in Figure 2-2 and are described below.

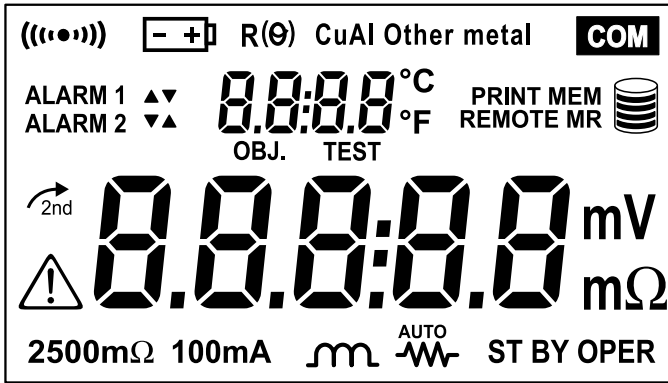







Figure 2-2

((••••))	Buzzer ON
- +	Battery condition
R (Θ)	Temperature compensation ON
Cu	Copper metal type selected
Al	Aluminum metal type selected
Other metal	User defined metal type selected
COM	Communication port active
Alarm 1 ▲	Alarm 1 active with high set point
Alarm 1 ▼	Alarm 1 active with low set point
Alarm 2 ▲	Alarm 2 active with high set point
Alarm 2 ▼	Alarm 2 active with low set point
OBJ.	First position locator for data stored in memory
TEST	Second position locator for data stored in memory
°C / °F	Temperature displayed in either degrees Centigrade or Fahrenheit
PRINT	Printing current test result or tests stored in memory

MEM	Displayed measurement about to be stored in memory
REMOTE	Instrument under computer control
MR	Memory recall
	Memory utilization indicator
mV mΩ	Units of measure
	Resistive material test mode selected
	Inductive material test mode selected
AUTO	Repetitive test mode selected
ST BY	System idle ready to start a test
OPER	Test in process
	Second function of a button activated
	CAUTION! Refer to the user manual before using the instrument
2500Ω 1mA	2500 ohm, 1 milliamp test range selected
250Ω 10mA	250 ohm, 10 milliamp test range selected
25Ω 100mA	25 ohm, 100 milliamp test range selected
2500mΩ 1A	2500 milliohm, 1 Amp test range selected
250mΩ 10A	250 milliohm, 10 Amp test range selected
25mΩ 10A	25 milliohm, 10 Amp test range selected
5mΩ 10A	5 milliohm, 10 Amp test range selected

3. SPECIFICATIONS

3.1 ELECTRICAL

The Micro-ohmmeter Model 6255

Specifications are given for an ambient temperature of $73\text{ }^{\circ}\text{F} \pm 9\text{ }^{\circ}\text{F}$ ($23\text{ }^{\circ}\text{C} \pm 5\text{ }^{\circ}$), relative humidity of (45 to 75) % and a supply voltage of $6\text{ V} \pm 0.1\text{ V}$.

All specifications are subject to change without notice.

Measurement Method:

4-Wire Kelvin resistance measurement with compensation for stray/residual voltages.

Measurement Ranges:

Range	Resolution	Accuracy over 1 year $73\text{ }^{\circ}\text{F} \pm 9\text{ }^{\circ}\text{F}$ $(23\text{ }^{\circ}\text{C} \pm 5\text{ }^{\circ}\text{C})$	Measurement Current	Voltage Drop
5 m Ω	0.1 $\mu\Omega$	0.15 % \pm 1.0 $\mu\Omega$	10 A	50 mV
25 m Ω	1 $\mu\Omega$	0.05 % \pm 3 $\mu\Omega$	10 A	250 mV
250 m Ω	10 $\mu\Omega$	0.05 % \pm 30 $\mu\Omega$	10 A	2500 mV
2500 m Ω	0.1 m Ω	0.05 % \pm 0.3 m Ω	1 A	2500 mV
25 Ω	1 m Ω	0.05 % \pm 3 m Ω	100 mA	2500 mV
250 Ω	10 m Ω	0.05 % \pm 30 m Ω	10 mA	2500 mV
2500 Ω	100 m Ω	0.05 % \pm 300 m Ω	1 mA	2500 mV

Temperature Measurement: 3-wire 100 Ω Platinum RTD

Accuracy: $\pm 0.5\text{ }^{\circ}\text{C}$

Resolution: 0.1 $^{\circ}\text{C}$

Influence From Environment Conditions:

Temperature: 0.1 % per 10 $^{\circ}\text{C}$ typical, 0.25 % max

Humidity: 0.5 % max from (10 to 90) %

Battery Voltage: $\pm 0.1\text{ }%$ from (4.5 to 7.5) V

Open Circuit Voltage: 7 V_{DC} max

Operating Voltage: (5 to 6) V_{DC}

Power Source:

Rechargeable 6 V, 8.5 A·h NiMH battery pack, built-in (90 to 256) V (45 to 420) Hz charger

Battery Life: 5000 10 A tests (typical)

Battery Charging: 120/240 V_{AC} $\pm 20\text{ }%$ (45 to 400) Hz line voltage

Auto-Power Off: when battery voltage $<5.0\text{ V}$

Low Battery Indication: The  symbol is displayed when the battery needs to be charged.

Overload Input Protection: 250 V_{RMS}

Fuses:

- F1 - 1 1/4 x 1/4 in (6.3 x 32 mm), fast acting, 16 A/250 V current source protection
- F2 - 3/4 x 3/16 in (5 x 20 mm), fast acting, 2 A/250 V charging circuit protection

3.2 MECHANICAL

Dimensions: (10.63 x 9.84 x 7.09) in (270 x 250 x 180) mm

Weight: 8.1 lbs (approximately 3.69 kg) without leads

Case Protection: ABS plastic polycarbonate: watertight to IP64 (cover closed), water resistant to IP53 (cover open)

Color: Safety yellow case with gray faceplate

3.3 DISPLAY

Blue Electroluminescent backlit Liquid Crystal Display (LCD), 2.25 x 4.00 in (57.2 x 102 mm) with icons and two numeric fields for data presentation.

One numeric field contains 4 digits for displaying ambient and reference temperature levels on the top line in **temperature compensation** mode. The other contains 5 digits and is used to display the measured values on the bottom line. Error messages are also listed on the bottom line.

3.4 ENVIRONMENTAL

Operating Temperature:

(14 to 132) °F (-10 to 55) °C, (10 to 80) % (non-condensing)

Storage Temperature: (-40 to 140) °F (-40 to 60) °C

3.5 SAFETY



EN 61010-1, 50 V, CAT III, Pollution Degree 2

Conducted and radiated emission:

EN 55022, class B

EN 61000-3-2

EN 61000-3-3

Immunity:

EN 61000-4-2 electrostatic discharges

EN 61000-4-3 radiated fields

EN 61000-4-5 shock

EN 61000-4-6 conducted disturbances

EN 61000-4-11 voltage drops

EN 61000-4-4 bursts

4. OPERATION







NOTE: Fully charge the instrument's battery before use.

4.1 QUICK SUMMARY

The following is a summary instruction set that will assist the operator in performing measurements. For complete details on each function and test method refer to the operating procedure section (§ 4.3) and instrument configuration section (§ 4.2) in this manual.



WARNING: Read and follow all safety warnings outlined in Section 1.3 **Precautions for Use**, before operating this instrument.

1. Turn the instrument on and select a test range by turning the rotary switch to the desired position. If the resistance of the device under test is unknown, start with the highest range (2500 Ω) and work down to increase resolution as necessary.
2. Select the test method best suited for the measurement by pressing the  button to select inductive (continuous test), resistive (instantaneous test) or AUTO (multiple testing).
3. Activate the backlight, if necessary, by pressing the  button.
4. Activate the buzzer, if desired, by pressing yellow **2nd** button followed by the  button.
5. Activate alarms, if desired, by pressing the yellow **2nd** button followed by the **ALARM** button. Successive presses of this two-button sequence will select Alarm 1, Alarm 2 or both.
6. Select the metal type for the device under test by pressing the yellow **2nd** button followed by the **METAL** button. Successive presses of this two-button sequence will select Copper (Cu), Aluminum (Al) or Other metal. This will be needed for temperature compensation.
7. Activate temperature compensation by pressing the **R** (). The reference temperature will appear followed by the ambient temperature on the top line of the display.
8. Start the test by pressing the **START/STOP** button. The resistance reading will appear on the lower line of the display. The symbol **OPER** will appear on the lower left to indicate that a test is in process. The Stand-by symbol **ST BY** will appear when the test is completed. Resistive element tests will stop automatically. Inductive and AUTO testing will stop when you push the **START/ STOP** button a second time.
9. Store the test result in memory by pressing the **MEM** button at the conclusion of a test. The next available location will be presented on the top line of the display. To use this location, press the **MEM** button a second time.

10. Recall readings from memory by pressing the yellow **2nd** button followed by the **MEM** button. The last measurement stored in location OBJ: X TEST: X will be displayed.

Use the **▲**, **▼** and **▶** buttons to select the object and test memory location to review. All information from the measurement is available for review including metal type, ambient and reference temperatures, resistance at ambient and reference temperatures, test range and test current.

Typical Operational Display:

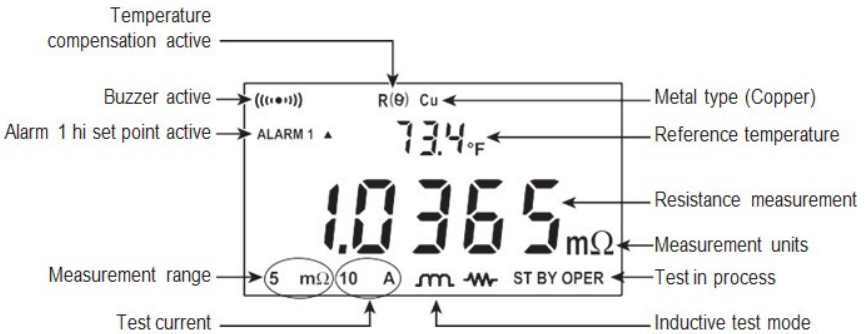

Figure 4-1

4.2 INSTRUMENT CONFIGURATION (SET-UP MODE)

4.2.1 Program Menu Tree

The menu tree below shows the order in which functions appear in the Menu and sub-menus of set up mode.

Set

r5 – OFF – Trig – PC – uT100 – Print

buzz – off – low high

EdSn – displays internal serial number

EdPP – displays firmware number

Lang – Lg Gb – Lg F

trEF – value

tAnb – Prb – nPrb

nEtA – Copper alpha – Aluminum alpha, Other Metal

ALPH – value

dEg – dEgF – dEgC

ALAr – Alarm 1 – Alarm 2

LlgH – t=OFF – t=1 – t=5 – t=10

nEn – dEL – dEL O – Y – n

The cursor buttons ▲, ▼ and ► have the following functions in the SET-UP menu:

- The up Arrow ▲ button selects the next function to be programmed in the top level menu and increments the value of the flashing variable in the sub-menus.
- The down Arrow ▼ button selects the previous function to be programmed in the top level menu and decrements the value of the flashing variable in the sub-menus.
- The right arrow ► button selects the function displayed in the top level menu and moves the cursor one place to the right or validates the programming in the sub-menus. See Cables and Printer Used with the Interface Port (§ 5.3) for proper connections.

4.2.2 Program the 9-Pin Interface Port (rS)

The 9-pin interface port on the top right side of the front panel can be programmed to any of five communication methods. These consist of:

- **Off:** Disable input and output functions of the interface port. This saves battery power.
- **Trigger:** Enables the remote measurement function.
- **PC:** Activates an RS-232 link between a computer and the unit for configuring the Model 6255 and for conducting tests and storing results. When activated, the **COM** icon will appear on the display.
- **VT100:** Activates an RS-232 link between a display terminal and the Model 6255. When activated, the **COM** icon will appear on the display.
- **Print:** Activates the RS-232 link between a printer and the Model 6255 for direct printing of test results. When activated, the **COM** icon will appear on the display.

The RS-232 modes also allow programming of transmission speed. The baud rate choices are: 4800, 9600, 19200 and 31250.

The required data configuration settings are: 8 bits, no parity, 1 stop bit, hardware control (CTS).

1. Turn the rotary switch to the SET-UP position.
2. Press the ▲ button until **rS** appears on the top line of the display.
3. Press the ► button, OFF will appear in the display.
4. Press the ► button to accept this setting or press the ▲ button to scroll through the other choices of trigger (trIG), PC, Terminal (ut100) and Print.
5. The choices of PC, terminal and print also require a baud rate selection.
6. After selecting PC, ut100 or Print, pressing the ► button will enter the baud rate selection menu.
7. Press the ▲ button to toggle the choices for 4800, 9600, 19200 and 31250. When the desired baud rate is in the display, validate it by pressing the ► button to return to the top level **rS** menu. The **COM** icon will appear in the display.
8. Proceed to the next programming variable by pressing the ▲ button.

4.2.3 Setting the Buzzer Level (bUZZ)

1. Turn the rotary switch to the SET-UP position.
2. Press the ▲ button until **bUZZ** appears on the top line of the display.
3. Press the ► button to scroll through the choices of OFF (no icon displayed), LOW (small buzzer icon (●●●) displayed) or HIGH (large buzzer icon (●●●●)) displayed). Each choice will display the corresponding icon in the top left corner of the display along with the associated audible sound.
4. When the desired sound level is displayed, press the ► button to accept it and return to the top level of buzzer set-up.
5. To proceed to the next programming variable, press the ▲ button.

4.2.4 Reading the Internal Serial Number (EdSn)

1. Turn the rotary switch to the SET-UP position.
2. Press the ▲ button until **EdSn** appears on the top line of the display.
3. Press the ► button to scroll through the serial number. There are 10 digits in the serial number. The first press will display the first five digits. The second press will display the second five digits.

EXAMPLE: First press displays: t0302
Second press displays: 044-0
Third press displays: 0001 A

4. Press the ► button again to return to the top level of the Serial Number set-up menu.
5. To proceed to the next programming variable, press the ▲ button.

4.2.5 Reading the Internal Software Version (EdPP)

1. Turn the rotary switch to the SET-UP position.
2. Press the ▲ button until **EdPP** appears on the top line of the display.
3. Press the ► button to display the firmware version.
4. Press the ► button again to return to the top level of the Software Version set-up menu.
5. To proceed to the next programming variable, press the ▲ button.

4.2.6 Setting the Language used for Printing Reports (LAnG)

1. Turn the rotary switch to the SET-UP position.
2. Press the ▲ button until **LAnG** appears on the top line of the display.
3. Press the ► button to enter the language selection sub-menu.
4. Next, press the ▲ button to toggle between English (Lg Gb) or French (Lg F).
5. Press the ► button to validate the selection and return to the top level of the Language set-up menu.
6. To proceed to the next programming variable, press the ▲ button.

4.2.7 Setting the Value for the Reference Temperature (trEF)

1. Turn the rotary switch to the SET-UP position.
2. Press the ▲ button until **trEF** appears on the top line of the display.
3. Press the ► button to enter the reference temperature sub-menu. The current reference temperature will be displayed with the leading digit flashing.
4. Use the ▲ button to change the leading digit. The minus (-) symbol can also be programmed in this location.
5. When the desired value is reached, press the ► button to move the next digit to the right.
6. Use the ▲ button to change this digit, then press the ► button to again move to the next digit to the right.
7. Repeat this process for each of the 5 digit locations.
8. After the 5th digit is programmed, press the ► button again to return to the top level of the Reference Temperature set-up menu.
9. To proceed to the next programming variable, press the ▲ button.



NOTE: The program limits for the reference temperature are (32.0 to 130.0) °F and (-10.0 to 130.0) °C. Attempting to set values outside these limits will cause error message **Err23** (Entry Out of Range) to appear in the display.

4.2.8 Selecting Method and Value for Ambient Temperature (tAnb)

1. Turn the rotary switch to the SET-UP position.
2. Press the ▲ button until **tAnb** appears on the top line of the display.
3. Press the ► button to enter the ambient temperature sub-menu.
4. The first choice here is to decide if ambient temperature will be measured using the RTD temperature probe accessory or if it will be programmed using the same method as described for reference temperature. **Prb** (measure the ambient temperature using the RTD probe accessory) or **nPrb** (no probe, manually enter the ambient temperature) will be displayed, press the ▲ button to toggle between the two choices.
5. If measuring the ambient temperature is desired, press the ► button when **Prb** is in the display. The lower display will momentarily show dashes **----** and then return to the top level ambient temperature menu.
6. If manually entering the ambient temperature is desired, press the ► button when **nPrb** is in the display. The ambient temperature may now be manually entered.
7. The current programmed ambient temperature will be displayed with the leading digit flashing.
8. Use the ▲ button to change the leading digit. The minus (-) symbol can also be programmed in this location.
9. When the desired value is reached, press the ► button to move the next digit to the right.

10. Use the ▲ button to change this digit then press the ► button to again move to the next digit to the right.
11. Repeat this process for each of the 5 digit locations.
12. After the 5th digit is programmed, press the ► button again to return to the top level of the ambient temperature set-up menu.
13. To proceed to the next programming variable, press the ▲ button.



NOTE: The program limits for the reference temperature are (32.0 to 130.0) °F and (-10.0 to 130.0) °C. Attempting to set values outside these limits will cause error message **Err23** (Entry Out of Range) to appear in the display.

4.2.9 Selecting the Metal Type (nEtA)

1. Turn the rotary switch to the SET-UP position.
2. Press the ▲ button until **nEtA** appears on the top line of the display.
3. Press the ► button to toggle through the choices of Copper (Cu), Aluminum (Al) or Other Metal. With each press of the right arrow button, the metal type icon appears at the top of the display. **nEtA** appears on the small display and the five digit alpha value appears on the large display and then automatically returns to the top level of the metal set-up menu.
4. To proceed to the next programming variable, press the ▲ button.

4.2.10 Programming the Alpha Value (ALPH)

1. Turn the rotary switch to the SET-UP position.
2. Press the ▲ button until **ALPH** appears on the top line of the display.
3. Press the ► button to begin programming the alpha value. See Table 2 in § 4.6 for common alpha values.
4. The current alpha value will be displayed with the leading digit flashing.
5. Use the ▲ button to change the leading digit. When the desired value is reached, press the ► button to move the next digit to the right.
6. Use the ▲ button to change this digit, then press the ► button to again move to the next digit to the right.
7. Repeat this process for each of the 5 digit locations.
8. After the 5th digit is programmed, press the ► button again to return to the top level of the alpha set up menu.
9. To proceed to the next programming variable, press the ▲ button.

4.2.11 Selecting Temperature Units (dEg)

1. Turn the rotary switch to the SET-UP position.
2. Press the ▲ button until **dEg** appears on the top line of the display.
3. Press the ► button to enter the degree units sub-menu.
4. Use the ▲ button to toggle through the choices of Fahrenheit (**dEGF**) or Centigrade (**dEGC**).

5. Press the ► button to validate the selection and return to the top level of the Temperature units set-up menu.
6. To proceed to the next programming variable, press the ▲ button.

4.2.12 Setting Alarm Set Point, Direction and Buzzer Level (ALAr)

1. Turn the rotary switch to the SET-UP position.
2. Press the ▲ button until **ALAr** appears on the top line of the display.
3. Press the ► button, Alarm 1 and its set point, direction and buzzer level will appear with ALARM 1 flashing.
4. To modify the settings of Alarm 1, press the ► button. The direction arrow will now be flashing. To modify Alarm 2 press the ▲ button, ALARM 2 will then be flashing.
5. When the direction arrow is flashing, it may be changed by pressing the ▲ button to toggle between HIGH (▲ activates above set point) and LOW (▼ activates below set point).
6. Press the ► button to adjust the buzzer level for this alarm. The buzzer icon (●●) will be flashing. The choices are OFF (no icon displayed), LOW (small buzzer icon (●●) displayed) or HIGH (large buzzer icon (●●●)) displayed). The selection is made by pressing the ▲ button while the icon is flashing.
7. Program the set point value used to trigger the alarm (ignoring the decimal point) by pressing the ► button. The leading digit will be flashing. Adjust the digit value using the ▲ button then press the ► button to move to the next digit to the right.
8. Repeat the process for each of the five digits.
9. Press the ► button when the numeric value is set to the desired number. The decimal point and units (mΩ or Ω) will be flashing.
10. Set the desired resolution and units by pressing the ▲ button. Each press will move the decimal point one place to the right. Cycling through milliohms and then through ohms.
11. To accept the alarm settings once the decimal point and units are at the desired values, press the ► button. This will bring you to Alarm 2. Repeat the process as necessary to set Alarm 2's conditions.
12. When Alarm 2 is set press the ► button to return to the top level of the alarm programming menu. **ALAr** will again appear on the top line and the bottom line will be blank.
13. To proceed to the next programming variable, press the ▲ button.

4.2.13 Setting the Display Timeout (LigH)

This setting determines the length of time that the backlight will stay on after the last button press. The choices are OFF (function disabled, backlight stays on continuously when activated), 1, 5 or 10 minutes.

1. Turn the rotary switch to the SET-UP position.
2. Press the ▲ button until **LigH** appears on the top line of the display.

3. Press the ► button. The last programmed value will appear in the display.
4. Press the ▲ button to toggle through the choices of OFF, t=1, t=5 and t=10.
5. When the desired length of time is in the display, press the ► button to validate the selection.
6. To proceed to the next programming variable, press the ▲ button.

4.2.14 Clearing the Memory (nEn)

You can choose to clear the entire memory or the contents of a specific object.

1. Turn the rotary switch to the SET-UP position.
2. Press the ▲ button until **nEn** appears on the top line of the display.
3. Press the ► button. **dEL** will appear on the lower line of the display.
4. Toggle between clearing the entire memory (dEL) or a specific object (dEL O) using the ▲ button.
5. To clear a specific object, press the ► button when **dEL. O** is in the display. The top line will display **Obj 01** with the **0** flashing. Use the arrow buttons to select the object to be deleted.
6. The lower display will show **dEL.02** for example if object number 2 is selected for deletion. As you press the ▲ button, the selected object will increment accordingly.
7. Delete the selected object by first pressing the ► button and toggling between Yes **dEL. Y** or No **dEL. n**
8. Pressing the ► button while **dEL. Y** is in the display will delete the contents of the selected object. The display will momentarily display dashes **----** and then return to display the next highest object location.
9. Pressing the ► button while **dEL. n** is in the display will cancel the request.
10. Repeat this process for each object to be deleted.
11. To clear the entire memory contents, turn the rotary switch to the SET-UP position.
12. Press the ▲ button until **nEn** appears on the top line of the display.
13. Press the ► button, **dEL** will appear on the lower line of the display.
14. Delete all data from memory by first pressing the ► button, then toggling between Yes **dEL. Y** or No **dEL. n**
15. Pressing the ► button while **dEL. Y** is in the display will clear all memory of stored measurements.
16. Pressing the ► button while **dEL. n** is in the display will cancel the request.



NOTE: Only objects with data stored in them can be accessed.

To return to the beginning of the SET-UP menu, press the ▲ button when **nEn** is on the top line of the display.

4.3 OPERATING PROCEDURE



WARNING: Before performing the resistance test, verify that the sample under test is not energized.

4.3.1 Connections and Readings

Clean all surfaces before connecting test leads. Verify a solid connection between test leads and the sample. Set the range selector switch to the desired range for the test. If the anticipated resistance is not known, begin with the highest range (2500 Ω) and successively lower the range selection until adequate resolution is achieved. The START/STOP button will need to be pressed each time you change ranges. The range selection may be changed while the instrument is on.

A diagram of the measurement system is shown in Figure 4-2. The Model 6255 generates a current (I) from the internal voltage source (V). A voltmeter measures the voltage drop V_x at the Kelvin probe contact points to the resistance to be measured (R_x) and displays the resistance measurement (R_x) directly using the formula $R_x = V_x / I$.

The result is not affected by the other resistances encountered in the current loop (R_i , R_f , R_c), as long as the total voltage drop induced across R_x remains below the voltage supplied by the source which is between (5 to 6) V. The maximum admissible lead resistance level is $R_f \approx (V - V_x) / I$. The use of Kelvin probes helps, as they eliminate the effect of the lead resistance (R_f).

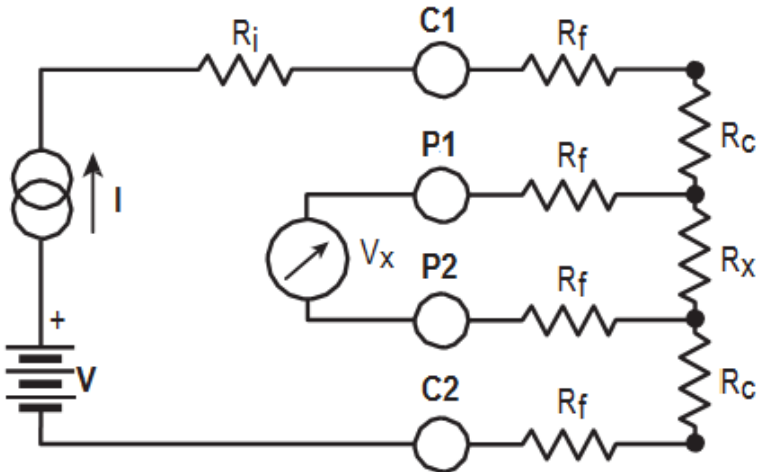

Figure 4-2

R_i = Unit internal resistance

R_c = Contact resistance

R_f = Lead resistance

R_x = Resistance to be measured

4.3.2 Test Lead Connection

The measurement leads are connected using the four binding posts on the left side of the front panel as shown in Figure 4-3.

Any drop in the voltage on the load terminals is measured between the two **voltage (V)** leads, P1 and P2. The current leads (C1 and C2) can deliver current from 1 mA to 10 A.

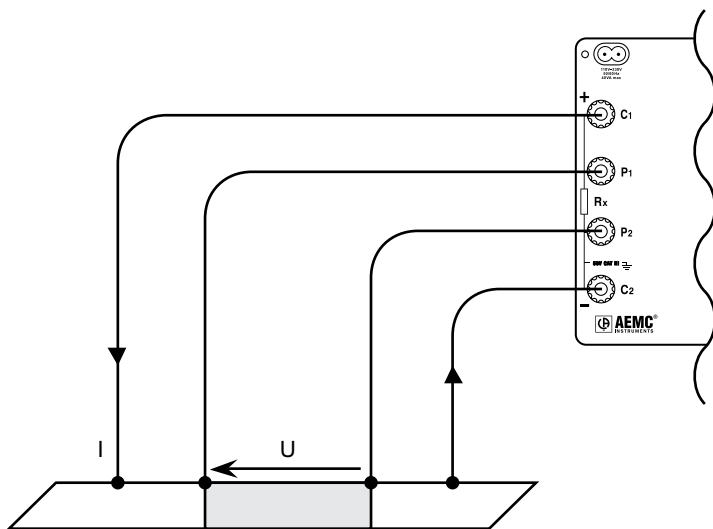

Figure 4-3

4.3.3 Very Low Resistance

When measuring very low resistive values in the $\mu\Omega$ range, the presence of stray DC currents may affect the accuracy of the measurements. These currents can be present due to a variety of reasons including chemical or thermal EMF in samples made of dissimilar metals. These EMFs are automatically compensated for during the measurement process.

The presence of AC interference in the sample under test may cause the measured value on the display to fluctuate. This interference may become more noticeable in the presence of strong electric fields. The effects of this interference may be reduced by twisting the leads around each other.

4.3.4 Meter Readings

When testing resistive samples, the meter reading will stabilize within the first few hundred milliseconds. On inductive loads (e.g. transformers), the measurement reading may take from several seconds to a few minutes to stabilize and depends greatly on the type of equipment and the impedance of the equipment under test. On very large samples such as utility transformers, (10 to 15) minutes charging time may be necessary.

4.3.5 Stand-by (ST BY) State

This is the position that the Model 6255 returns to at the end of a measurement cycle after:

- the operator presses the START/STOP button during a test
- any changes to the position of the rotary switch
- every low inductive mode measurement
- an error is detected

4.4 SELECTING THE TEST RANGE

The Model 6255 has seven test ranges to choose from. Table 1 lists the maximum resistance, test current and resolution for each range.

Resistance Range	Test Current	Resolution
2500 Ω	1 mA	100 m Ω
250 Ω	10 mA	10 m Ω
25 Ω	100 mA	1 m Ω
2500 m Ω	1 A	0.1 m Ω
250 m Ω	10 A	10 $\mu\Omega$
25 m Ω	10 A	1 $\mu\Omega$
5 m Ω	10 A	0.1 $\mu\Omega$

Table 1

Turn the rotary switch to the desired range, the range and test current will appear on the lower left side of the display.

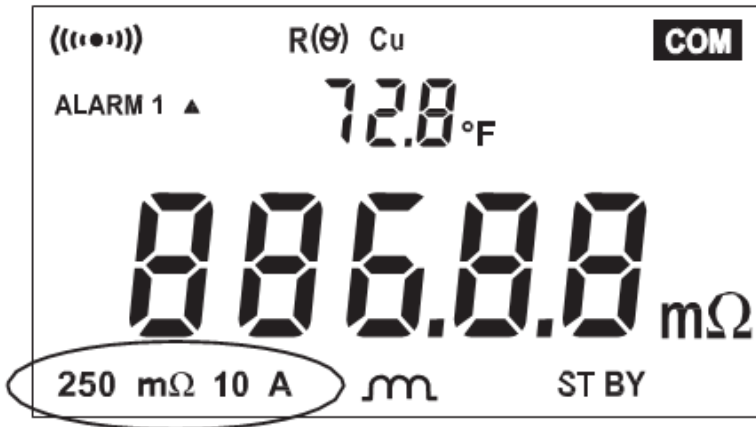

Figure 4-4

The Model 6255 is now ready to start a test.

4.5 MEASUREMENT MODES



NOTE: For descriptions of all Fault Indicator (Error) codes, refer to § 7, Troubleshooting.

4.5.1 Measurement Safety Warnings

WARNINGS

- Never use test leads or measuring wires if there is any evidence of deterioration (insulation split, burnt, etc.).
- Never exceed the safety values indicated in the specifications.
- Never connect the unit to a live circuit.

When the unit is measuring resistance showing a high inductive component (transformers, motors, etc.) after ending the measurement (with the measurement current cut-off), the unit then discharges this inductance and displays the icon for this entire duration.

- Never disconnect the connection wires before the icon disappears.

4.5.2 Inductive Resistance Measurement Mode ()

This mode is intended for performing measurements on inductive devices. Press the button until the icon shows on the display.

From the Stand-by state, start a test by performing the following:

1. Connect the Kelvin probes to the test specimen.
2. Press the **START/STOP** button.
3. If the Kelvin probes are incorrectly connected, the display will show error message **Err 11** (current leads incorrectly connected), or **Err 12** (voltage leads incorrectly connected). The instrument will then return to the Stand-by state. When the error is corrected, the test automatically begins again.
4. With the current switched off, the residual voltage (V_0) across the resistor terminals is measured and displayed. If this voltage level is too high, **Err 13** will be displayed.
5. The current (I) is switched on at the start of a measurement and remains on continuously until the unit is manually returned to the Stand-by state by pressing the **START/STOP** button.
6. The voltage across the resistor terminals (V_1) is measured and the measurement $R = (V_1 - V_0) / I$ is displayed.
7. All subsequent measurements comprise only a V_n measurement as V_0 remains in memory. The timing sequence for measurement is shown in Figure 4-5.



NOTE: After ending the measurement, with the current turned off, the Model 6255 will discharge the device under test as long as the test leads are connected to the device.

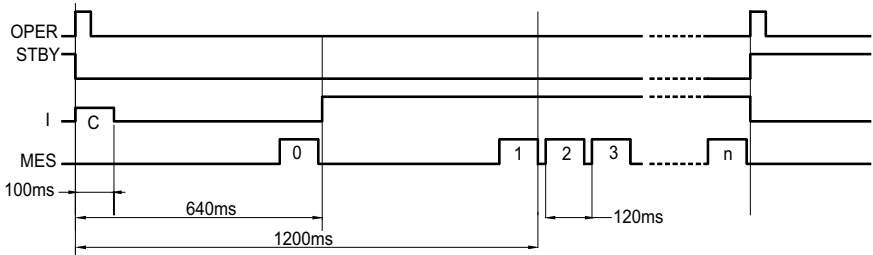

Figure 4-5

C = connection check

0 = residual voltage measurement (stored)

1,2,3...n = successive voltage measurements across the resistor terminals

8. The test is stopped by pressing the **START/STOP** button.
9. Store the measurement by first pressing the **MEM** button, then select the object and test location to store the measurement using the arrow buttons. When the desired location has been selected, press the **MEM** button a second time to complete the data storage process.



4.5.3 Resistance Measurement Mode ()

This mode is intended for measuring contact and metal plating resistance levels. As a general rule, any resistance level on material with a time constant that is less than a few milliseconds.

In this mode, only one measurement is performed per cycle. When the **START/STOP** button is pressed, the test current is applied for approximately 400 milliseconds. Residual voltage is measured, a resistance measurement is taken and the test stops automatically.

The advantages of the resistance mode include:

- Reduced power consumption as the test current is off between measurements.
- Less heating of the measured resistance.
- Improved compensation of stray voltages as these are measured and compensated before each resistance measurement.

Press the  button until the  icon shows on the display.

From the Stand-by state, start a test by performing the following:

1. Connect the Kelvin probes to the test specimen.
2. Press the **START/STOP** button.
3. If the Kelvin probes are incorrectly connected, the display will show error message **Err 11** (current leads incorrectly connected), or **Err 12** (voltage leads incorrectly connected). The unit will then return to the Stand-by state. When the error is corrected, the test can begin again by pressing the **START/STOP** button.
4. With the current switched off, the residual voltage (V_0) across the resistor terminals is measured. If this voltage level is too high, the unit displays **Err 13** and returns to Stand-by position. (Refer to § 7, Troubleshooting, for all error message descriptions.)
5. The current (I) is switched on when the **START/STOP** button is pressed.
6. The voltage across the resistor terminals (V_1) is measured and then the current is removed.
7. The measurement resistance result $R = (V_1 - V_0) / I$ is displayed or error message **Err 07** is displayed, if an over range condition occurs.

The Model 6255 then returns to the Stand-by state at the end of the measurement. The instrument is ready to perform another measurement.

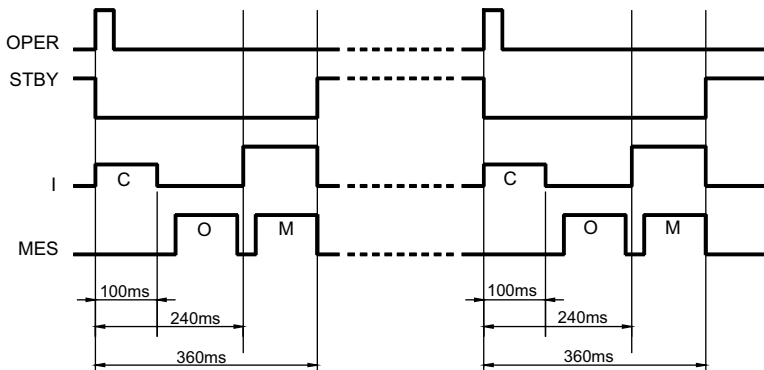

Figure 4-6

C = connection check

O = residual voltage measurement

M = measurement of the voltage across the resistor terminals.

8. Store the measurement by first pressing the **MEM** button, then select the object and test location to store the measurement using the arrow buttons. When the desired location has been selected, press the **MEM** button a second time to complete the data storage process.

4.5.4 Low Inductive Resistance Automatic Triggering Measurement Mode

This mode is intended only for measuring resistance on material without a time constant (non-inductive). The use of the spring loaded Kelvin pistol grip probes (Cat. #2118.84 or Cat. #2118.85) listed in the Accessories section is recommended for this mode.

From the Stand-by state, start a test by performing the following:

1. Press the  button until the **AUTO** icon shows on the display.
2. Press the **START/STOP** button.
3. Connect the probes to the specimen. The unit waits until it detects that the current and voltage leads are connected correctly.
4. Residual voltage (V_0) measurement across the resistor terminals is measured.
5. The measurement current (I) is established, the voltage across the resistor terminals (V_1) is measured and the measurement resistance result $R = (V_1 - V_0) / I$ is displayed.
6. To start a new measurement cycle, Release at least one probe, and then reconnect it to the next point or specimen.

NOTE: If the range is exceeded, the instrument displays **Err 07**.



Changing the range switch position will stop the test cycle and return to the Stand-by state. Each measurement taken during the test cycle can be temperature compensated and stored while the test cycle is running.

-
7. Store the measurement of each specimen or point by first pressing the **MEM** button, then select the object and test location to store the measurement using the arrow buttons. When the desired location has been selected, press the **MEM** button a second time to complete the data storage process.
 8. The test is stopped by pressing the **START/STOP** button.

4.6 AMBIENT TEMPERATURE COMPENSATION

The metals used in the windings of certain devices (for example, the copper wire used in transformer or motor windings) have high temperature coefficients in the order of 0.4 %/°C (for copper or aluminum). This results in resistance measurements that are highly dependent on the temperature of the device. Activating temperature compensation will correct for this condition.

The Temperature Compensation function can be accessed by pressing the **R** () button before the start of a test in Resistance and Inductive resistance measurement mode. It can also be activated at any time during Auto measurement mode.

Its purpose is to compensate the measured or resistance value at the ambient temperature (whether measured or programmed), to the resistance value that it should have at a reference temperature.

The compensated resistance level is expressed as follows:

$$R(T_{ref}) = \frac{R(T_{amb}) * (1 + \alpha * T_{ref})}{1 + (\alpha * T_{amb})}$$

Where:

R(T_{amb}) = the resistance value measured at ambient temperature

T_{amb} = the temperature measured by a Pt100 probe or programmed by the operator

alpha = the temperature coefficient of the chosen metal (Aluminum, Copper, Other metal)

T_{ref} = the programmed reference temperature to which the measurement is compensated

The Temperature Coefficient of copper (near room temperature) is +0.393 percent per degree C. This means if the temperature increases 1 °C the resistance will increase 0.393 %.

EXAMPLE: You have 100 ft of 20 gage wire and its resistance is 1.015 Ω at 20 °C (room temp). If the temperature of the wire goes up 10 °C the resistance will change by 0.0399 Ω (10 ° * 0.00393 / ° * 1.015 Ω = 0.0399 Ω).

The wire resistance will now be 1.015 Ω + 0.0399 Ω= 1.0549 Ω.

The following table provides the temperature coefficients of the more common metals and alloys.

The alpha values for copper and aluminum are pre-programmed into the Model 6255. Others may be programmed by selecting **Other Metals** and then programming in the alpha constant from the table or other sources.

Material	Element / Alloy	alpha per ° C x 10 ⁻³
Aluminum	Element	4.030
Copper	Element	3.930
Nickel	Element	5.866
Iron	Element	5.671
Molybdenum	Element	4.579
Tungsten	Element	4.403
Silver	Element	3.819
Platinum	Element	3.729
Gold	Element	3.715
Zinc	Element	0.847
Steel	Alloy	3.000
Nichrome	Alloy	0.170
Nichrome V	Alloy	0.130

Table 2

A 100 Ω platinum RTD can be connected to the front panel of the Model 6255 to perform compensated measurements. The temperature sensor and extension cable assembly, listed in the Accessories section, are recommended. The three pin temperature compensation port is located to the left of the interface port and is configured as shown in Figure 4-7.

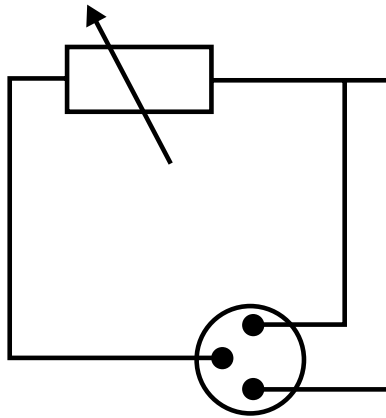

Pt100 connector

Figure 4-7

To measure the ambient air temperature at the Model 6255, plug the optional temperature sensor directly into the temperature port on the front panel as shown in Figure 4-8.



Figure 4-8

To measure the ambient temperature at the specimen, plug the optional temperature sensor onto the extension cable and plug the extension cable into the temperature port on the front panel as shown in Figure 4-9.

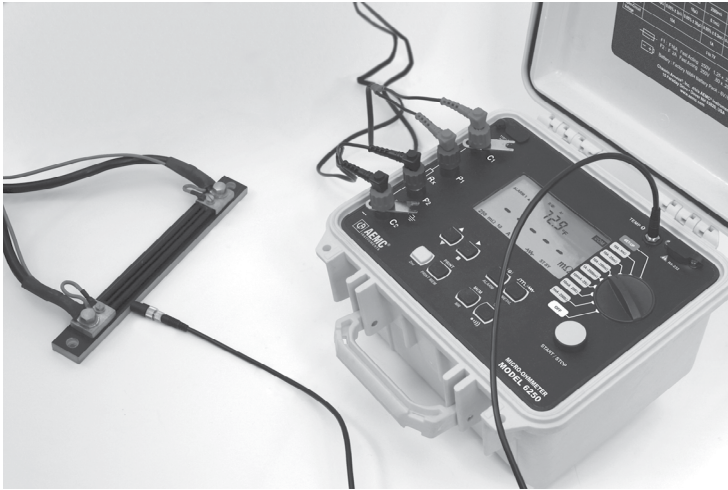

Figure 4-9

Place the temperature sensor in contact with the specimen or in close proximity to it. Allow two minutes for the sensor to normalize to the specimen temperature before starting a temperature compensated measurement.

4.6.1 Activating the Compensation Function

Check to ensure that all desired programming and connections are made correctly. See **Setting the Value for the Reference Temperature** (§ 4.2.7) and **Selecting the Method for Ambient Temperature** (§ 4.2.8).

1. Select the range and the measurement mode.
2. Press the **R (Θ)** button. The following information will be displayed on-screen:
 - R (Θ)**
 - Metal type selected (Cu, Al or Other Metal)
 - Temperature levels T_{ref} followed by T_{amb}
3. Press the **START/STOP** button.
4. The unit performs a measurement cycle and directly displays the compensated resistance value and, depending on set-up, displays one of the following:
 - Programmed ambient temperature level
 - Temperature level measured by the temperature sensor
 - if the temperature sensor is activated but is incorrectly connected or not connected at all
 - Measured temperature is out of range (14 to 131) °F (-10 to 55) °C)

If the temperature is out of range or if the sensor leads are disconnected, the Model 6255 displays **Err 10**.

Temperature compensation can be toggled ON or OFF after the measurement is completed, in resistive and inductive modes or at any time in AUTO mode.

4.7 ACTIVATING ALARMS

The alarm programming menu offers the option of choosing one or two alarm thresholds. An alarm comprises a value, an activation direction (above ▲ or below ▼ the set point) and a sound level setting for the buzzer, should the alarm become active.



NOTE: Alarms are activated by successively pressing the **2nd** button followed by the **ALARM** button.

The display will indicate one of the following after each set of button presses:

- Alarm 1 and the activation direction, ▲ or ▼
- Alarm 2 and the activation direction, ▲ or ▼
- Alarm 1 and Alarm 2 and activation directions, ▲ or ▼ for each

These values and direction parameters are programmable. See **Setting Alarm Set Point, Direction and Buzzer Levels** (§ 4.2.12). The buzzer will sound when Alarm 1 and/or Alarm 2 threshold values are reached.

5. MEMORY / PRINTING

5.1 MANAGING AND PRINTING THE DATA IN MEMORY

The memory is organized into locations called Objects and Tests.

There are 99 objects, each containing a maximum of 99 tests (measurements). The maximum number of measurements that can be stored is approximately 1500.

After taking a measurement, it may be stored in memory by pressing the **MEM** button. The **MEM** icon blinks and the first available Object and Test location for storing this measurement is displayed with the last digit of the test number blinking.

EXAMPLE: Object 1 and Test 4 are displayed and the 4 will be blinking.

01:04.

OBJ : TEST

The object and test location can be changed using the arrow buttons.

- **FREE** is displayed when the location is empty
- **OCC** is displayed when the location has data stored in it

After choosing the measurement's memory location, pressing the **MEM** button a second time validates memory storage in a **FREE** location.

If an occupied location is selected, the **OCC** message blinks to warn that this memory location is already taken. Storage action in this location requires pressing the **MEM** button again. The previous measurement in this location will be replaced by the new measurement.

5.2 DISPLAYING AND PRINTING STORED MEASUREMENTS



NOTE: To display or print a measurement result stored in memory, press the yellow **2nd** button followed by the **MR** button.

The measurement value for the last object and test saved is displayed.

EXAMPLE: Object Object 1 and Test 3 are displayed.

01:03.

OBJ : TEST

The test unit number will be blinking. In this example the 3 will be blinking.

Change the object and test numbers using the arrow buttons. As you change memory locations, the stored measurement value will be displayed. The following measurement components are also accessible if stored.

The selected memory location will display:

- Number of the object and test that correspond to the memory location
- Active range and current level during the measurement
- Measurement value with any compensation used
- Alarm icon for any active alarms that occurred during the measurement

The parameters set for the alarm threshold, reference temperature, ambient temperature and metal correction coefficient are not directly accessible. They are accessible by pressing the following:

- Press the **R** (⊖) button to display ambient temperature at the time of the stored measurement.
- Press the **R** (⊖) button a second time to display the reference temperature that the measurement was compensated to.
- Press the **Ⓜ** / **Ⓜ** button to display the type of metal and alpha value used for compensation at the time of the measurement.
- Press the **PRINT** button to print the measurement results stored at the current memory location. An optional serial printer is required for this feature.



NOTE: Only memory locations with stored measurements are accessible.

Measurement data stored in memory can be accessed directly from any switch position except OFF and SET-UP for printing.

- Press the yellow **2nd** button followed by the **PRINT MEM** button to access measurement results stored in memory for printing. An optional serial printer is required for this feature. Use the arrow buttons to select the object and test to be printed.

A typical printed report using an optional printer is shown below.

```

_____  

CHAUVIN ARNOUX - CA6250  

NUMBER : .....  

_____  

OBJECT:                TEST:  

DESCRIPTION: .....  

.....  

.....  

Meas. Date   :      _/ _/ _  

Meas. Type   :                LOW INDUCTIVE  

Metal Type   :                Cu  

Coeff. Metal :                3.93  

Measurement Temperature :    23.2 C  

Reference Temperature   :    20.0 C  

Resistance Value (Tamb)  :    1294.6 Ohm  

Resistance Value (Tref)  :    1287.2 Ohm  

COMMENTS : .....  

.....  

.....  

Next test date :      _/ _/ _
    
```

Figure 5-1

Blank report forms can be downloaded from the AEMC® Instruments web site. Visit www.aemc.com/techinfo/index.asp and open the **Micro-Ohmmeters** link.

5.3 CABLES AND PRINTERS USED WITH THE INTERFACE PORT

The DB9 interface port can be used to trigger remote measurements

(TRIG). Wiring for remote triggering of a test is illustrated in Figure 5-2. The READY LED indicates that a measurement can be made.

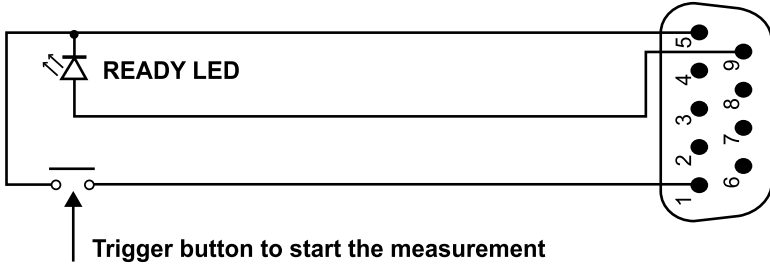
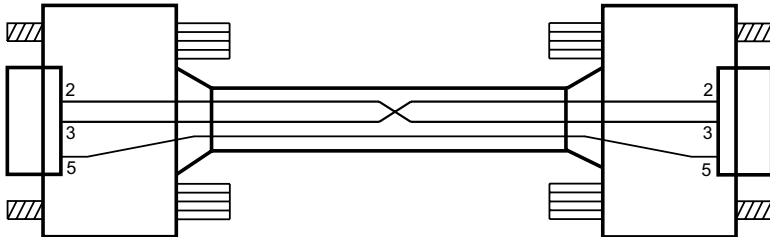

Figure 5-2

The DB9 interface port can be used for RS-232 communication with a PC, terminal or a printer. The main connection pins used are shown in Figures 5-3 and 5-4 respectively.

Connection to a PC or Terminal:



Male Connector	
Printer end	
	Pin
Rx	2
Tx	3
Gnd	5

Female Connector	
Printer end	
6255 end	
3	Tx
2	Rx
5	Grid

Figure 5-3

Direct Printer Connection:

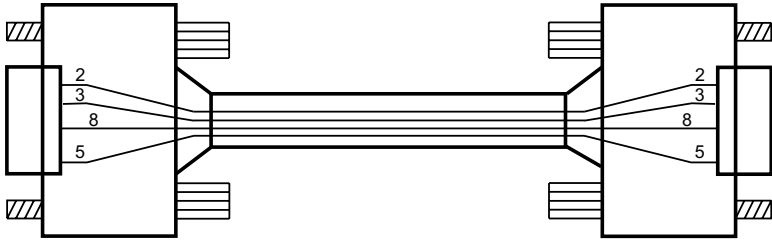

Male Connector	
Printer end	Pin
Rx	2
Tx	3
Gnd	5
CTS	8

Female Connector	
Printer end	Pin
3	Tx
2	Rx
5	Grid
8	CTS

Figure 5-4

6. DATAVIEW®

DataView® software with the Micro-Ohmmeter Control Panel (provided free with the product in North America, South America, and Australia) allows you to:

- Connect the instrument to a computer
- Configure and schedule a recording session on the instrument
- Download recorded data from the instrument to the computer
- Generate reports from downloaded data
- View instrument measurements in real time on the computer



NOTE: Do not connect the instrument to the computer before installing the software and drivers.

To install DataView on a computer:

1. Insert the USB drive that comes with the instrument into a USB port on your computer.
2. If Autorun is enabled, an AutoPlay window appears on your screen. Click **Open folder to view files** to display the DataView folder. If Autorun is not enabled or allowed, use Windows Explorer to locate and open the USB drive labeled **DataView**.
3. When the DataView folder is open, double-click the file **Setup.exe** in the root directory.
4. The Setup screen appears. This enables you to select the language version of the setup program. You can also select additional install options (each option is explained in the Description field). Make your selections and click **Install**.
5. Click **OK** to confirm setup. The InstallShield Wizard screen appears. This program leads you through the DataView install process. As you complete these screens, be sure to check **Micro-Ohmmeters** when prompted to select features to install.
6. When the InstallShield Wizard finishes installing DataView, the Setup screen appears. Click **Exit** to close. The DataView folder appears on your computer desktop.
7. Open the DataView folder on your desktop. This displays a list of icons for the Control Panel(s) installed with DataView.
8. Open the DataView Micro-Ohmmeter Control Panel by clicking the  icon.

For more information, consult the DataView Micro-Ohmmeter Control Panel Help.

7. TROUBLESHOOTING

The Model 6255 incorporates internal diagnostics and will inform the operator of any condition needing attention through the use of error messages. The available messages are described below.

7.1 FAULT INDICATORS

Err 1	Low battery level
Err 2	Internal problem
Err 3	Unable to measure battery
Err 4	Unable to measure temperature
Err 5	Internal temperature too high - let the instrument cool down
Err 6	Unable to establish current measurement
Err 7	Measurement out of range
Err 8	Internal problem
Err 9	Measurement cycle stopped
Err 10	Temperature sensor incorrectly connected or missing
Err 11	Current leads incorrectly connected
Err 12	Voltage leads incorrectly connected or measured resistance too high
Err 13	Residual voltage too high
Err 21	Adjustment out of range
Err 22	Measured value out of range
Err 23	Entry out of range
Err 24	Unable to write to memory
Err 25	Unable to read memory
Err 26	Memory full
Err 27	Memory empty; no data available
Err 28	Memory check problem
Err 29	Object or test number incorrect



WARNING: If error message 2, 3, 4, or 8 appears, the instrument must be sent to a qualified organization for repair. See the Repair and Calibration section (§ 9.5) of this manual for return instructions.

8. APPLICATION EXAMPLES

The proper procedures for using the Model 6255 in some specific applications are described in this section.

8.1 MEASURING WINDING RESISTANCE OF MOTORS AND TRANSFORMERS



WARNING: Prior to and after testing a transformer winding, the energy stored in the magnetic field must be dissipated by shorting the transformer terminals. For additional safety, the transformer terminals should be jumpered together before the instrument is disconnected.

One terminal of the test specimen should be grounded for safety!

Make connections to the transformer as shown in Figure 8-1. On larger transformers, the measurement stabilization time will increase.

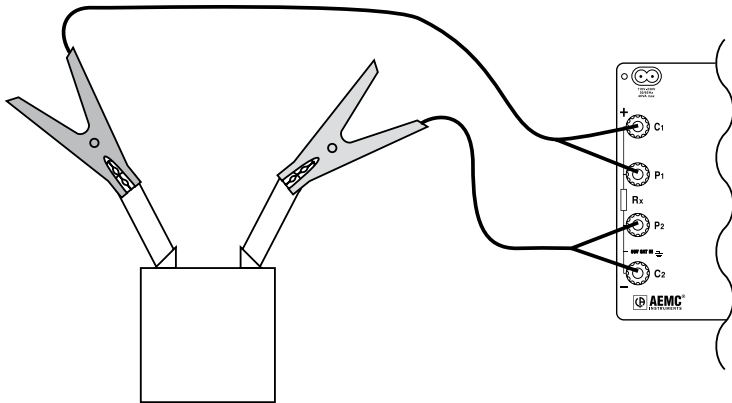

Figure 8-1

8.2 MEASURING RESISTANCE ON ELECTRIC MOTORS

For this test, Kelvin probes should be used (Figure 8-2). Make contact with each segment on the motor commutator. Allow approximately two seconds for the display to stabilize.

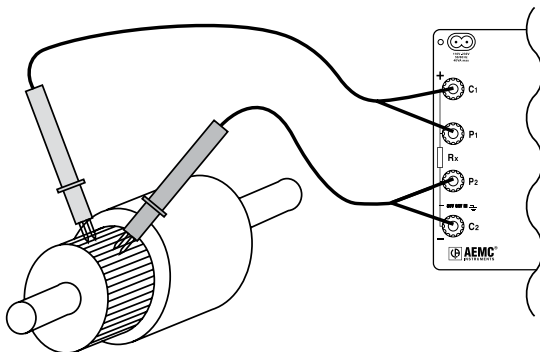

Figure 8-2

8.3 BATTERY STRAP MEASUREMENTS

Proper battery strap resistance measurements will help ensure proper voltage output. The resistance on battery strap connections should be measured using the Kelvin probes (see Figure 8-3). Measurements must be made with the system power turned off.

The average resistance of all the intercell connections should be determined by totaling the individual resistances and dividing by the number of connectors. Each individual cell resistance should not exceed the average by more than 10 %. See the manufacturer's specifications for typical resistance values.

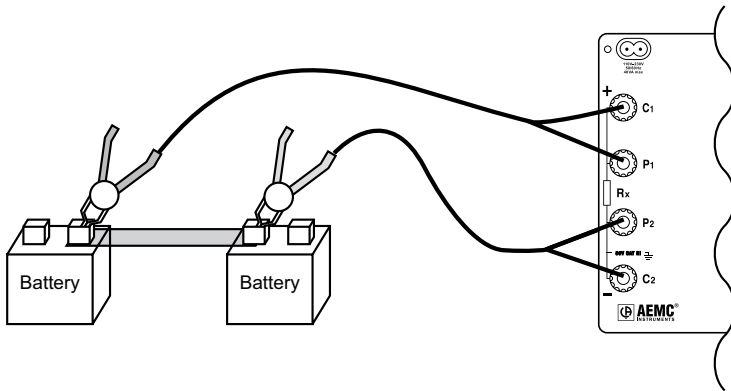

Figure 8-3

9. MAINTENANCE

Use only factory specified replacement parts. AEMC® Instruments will not be held responsible for any accident, incident, or malfunction following a repair done other than by its service center or by an approved repair center.

9.1 WARNING

- To avoid electrical shock, do not attempt to perform any servicing unless you are qualified to do so.
- Do not perform any service while the micro-ohmmeter is on any circuit.
- To avoid electrical shock and/or damage to the instrument, do not allow water or other foreign agents into the electronic module.
- Make sure the internal battery is fully charged prior to testing. If the instrument has been left unused for several months, charge the battery.
- We recommend charging the micro-ohmmeter every month to ensure a full battery charge when used.
- When replacing fuses, install only fuses which are direct replacements.

9.2 CLEANING



WARNING: Disconnect the instrument from any source of electricity.

- If the case needs cleaning, do not use any alcohol or oil based cleaners. Preferably use soapy water with a damp cloth or sponge.
- Dry immediately after cleaning. Avoid water penetration into the electronic module.
- Make sure the micro-ohmmeter and all leads are dry before further use.

9.3 CHARGING THE BATTERY

AC POWER SELECTION

The Model 6255 may be charged from (90 to 264) V_{AC} (45 to 420) Hz. The instrument includes a 110 V line cord, which provides the charging voltage for the rechargeable battery.

CHARGING THE BATTERY

The Model 6255 should be fully charged before using it for the first time. This may take up to 6 hours for a completely discharged battery.

If the instrument is in Standby mode and the battery symbol  is flashing (or <<Err01>> is displayed during a measurement), the battery needs to be charged. The battery will charge in both the ON and OFF mode.



- ON mode, the charging indicators will show on the display.
- OFF mode, no display will show during charging.

Connect the Model 6255 to 120 V_{AC} using the power cord provided (charging starts automatically).



NOTE: Testing cannot be conducted while charging the batteries. Button presses are ignored when charging is in process.

CHARGING INDICATORS

- **CHrg L:** instrument is **trickle charging**.
- **bAt CHrg:** with  flashing: instrument in **fast charge** mode.
- **bAt FULL** with  displayed (not flashing): charging is complete.

If the instrument continues to display **CHrg L** after several hours of charging, unplug the power cord and then plug it back in. The instrument should start in **fast charge** mode; if not the battery may be defective and need to be replaced.

9.4 BATTERY AND FUSE REPLACEMENT



NOTE: Ensure no terminals are connected and that the switch is in the OFF position before opening the front panel.

BATTERY

- Replacing the battery causes data to be lost from the memory.
- The battery should only be replaced by a qualified technician or sent back to the factory for replacement and standard calibration. See the Repair and Calibration section for return instructions.

FUSES

- Before replacing the internal batteries or fuses, the front panel must first be removed. Use a Phillips head screwdriver to remove the four screws from the feet on the bottom of the case.
- Pull out the chassis from the top.
- The two fuses are located on the left side of the chassis.
 - F1 is located near the C1 and P1 terminals.
 - F2 is located directly below on the bottom power supply board assembly.
- Fuse F1, is 0.25 x 1.26 in (6.3 x 32 mm) fast acting, 16 A/250 V, low internal resistance, protecting the current source from outside voltages on energized specimens.
- Fuse F2, is 0.2 x 0.79 in (5.0 x 20 mm) fast acting, 2 A/250 V, protecting the battery charger power supply board.

9.5 REPAIR AND CALIBRATION

To ensure that your instrument meets factory specifications, we recommend that it be sent back to our factory Service Center at one-year intervals for recalibration or as required by other standards or internal procedures.

For instrument repair and calibration:

You must contact our Service Center for a Customer Service Authorization Number (CSA#). Send an email to repair@aemc.com requesting a CSA#, you will be provided a CSA Form and other required paperwork along with the next steps to complete the request. Then return the instrument along with the signed CSA Form. This will ensure that when your instrument arrives, it will be tracked and processed promptly. Please write the CSA# on the outside of the shipping container. If the instrument is returned for calibration, we need to know if you want a standard calibration or a calibration traceable to N.I.S.T. (includes calibration certificate plus recorded calibration data).

Ship To: Chauvin Arnoux®, Inc. d.b.a. AEMC® Instruments
15 Faraday Drive ▪ Dover, NH 03820 USA
Phone: (800) 945-2362 (Ext. 360) / (603) 749-6434 (Ext. 360)
Fax: (603) 742-2346
E-mail: repair@aemc.com

(Or contact your authorized distributor.)

Contact us for the costs for repair, standard calibration, and calibration traceable to N.I.S.T.



NOTE: You must obtain a CSA# before returning any instrument.

9.6 TECHNICAL ASSISTANCE

If you are experiencing any technical problems or require any assistance with the proper operation or application of your instrument, please call, e-mail or fax our technical support team:

Chauvin Arnoux®, Inc. d.b.a. AEMC® Instruments
Phone: (800) 343-1391 (Ext. 351)
Fax: (603) 742-2346
E-mail: techsupport@aemc.com
www.aemc.com

9.7 LIMITED WARRANTY

The instrument is warranted to the owner for a period of two years from the date of original purchase against defects in manufacture. This limited warranty is given by AEMC® Instruments, not by the distributor from whom it was purchased. This warranty is void if the unit has been tampered with, abused, or if the defect is related to service not performed by AEMC® Instruments.

Full warranty coverage and product registration is available on our website at www.aemc.com/warranty.html

Please print the online Warranty Coverage Information for your records.

What AEMC® Instruments will do:

If a malfunction occurs within the warranty period, you may return the instrument to us for repair, provided we have your warranty registration information on file or a proof of purchase. AEMC® Instruments will repair or replace the faulty material at our discretion.

REGISTER ONLINE AT: www.aemc.com/warranty.html

9.7.1 Warranty Repairs

What you must do to return an Instrument for Warranty Repair:

First, send an email to repair@aemc.com requesting a Customer Service Authorization Number (CSA#) from our Service Department. You will be provided a CSA Form and other required paperwork along with the next steps to complete the request. Then return the instrument along with the signed CSA Form. Please write the CSA# on the outside of the shipping container. Return the instrument, postage or shipment prepaid to:

Chauvin Arnoux®, Inc. d.b.a. AEMC® Instruments
15 Faraday Drive, Dover, NH 03820 USA
Phone: (800) 945-2362 (Ext. 360)
(603) 749-6434 (Ext. 360)
Fax: (603) 742-2346
E-mail: repair@aemc.com

Caution: To protect yourself against in-transit loss, we recommend that you insure your returned material.



NOTE: You must obtain a CSA# before returning any instrument.

NOTES:

NOTES:



06/24
99-MAN 100458 v08

AEMC[®] Instruments
15 Faraday Drive • Dover, NH 03820 USA
Phone: +1 (603) 749-6434 • +1 (800) 343-1391 • Fax: +1 (603) 742-2346
www.aemc.com
