

Be safe, do more and save with the complete gas detection solution for your building's mechanical system – by Honeywell Analytics

The Complete Gas Detection System for Chiller Rooms



Chiller Room Monitoring

Eliminate the guesswork and hassle of knowing whether all your bases are covered. One complete system from Honeywell Analytics keeps you in compliance with ASHRAE 15 and CSA-B52, keeps you environmentally responsible by detecting the latest refrigerant gases, and maximizes protection from leaks. Our continuous, real-time monitoring system is the quickest, most reliable way to detect and respond to leaks. Unlike sample draw systems which take periodic samples of the air over time, our diffusion technology alerts you of a leak at the absolute earliest by continuously monitoring the air quality in real time. With no pumps, filters or tubes, installation and maintenance costs are also reduced.



301EM-20

Controller

The 301EM-20 is a controller for up to 20 sensors for refrigerant, toxic and combustible gases suiting a variety of gas detection system solutions for mechanical rooms.

301IRFS

Infrared refrigerant gas detector



The 301IRFS is an infrared refrigerant gas sensor used with the 301EM-20 in the complete mechanical room solution.



301EMRP-20

Controller remote panel

The 301EMRP-20 Remote Panel offers four relay outputs and visual indication of the gas concentration outside or inside the mechanical room and can connect to ten 301EMRP-20 Remote Panels.

Chiller Room Monitoring System



Figure 1 – Typical mechanical equipment room monitoring system

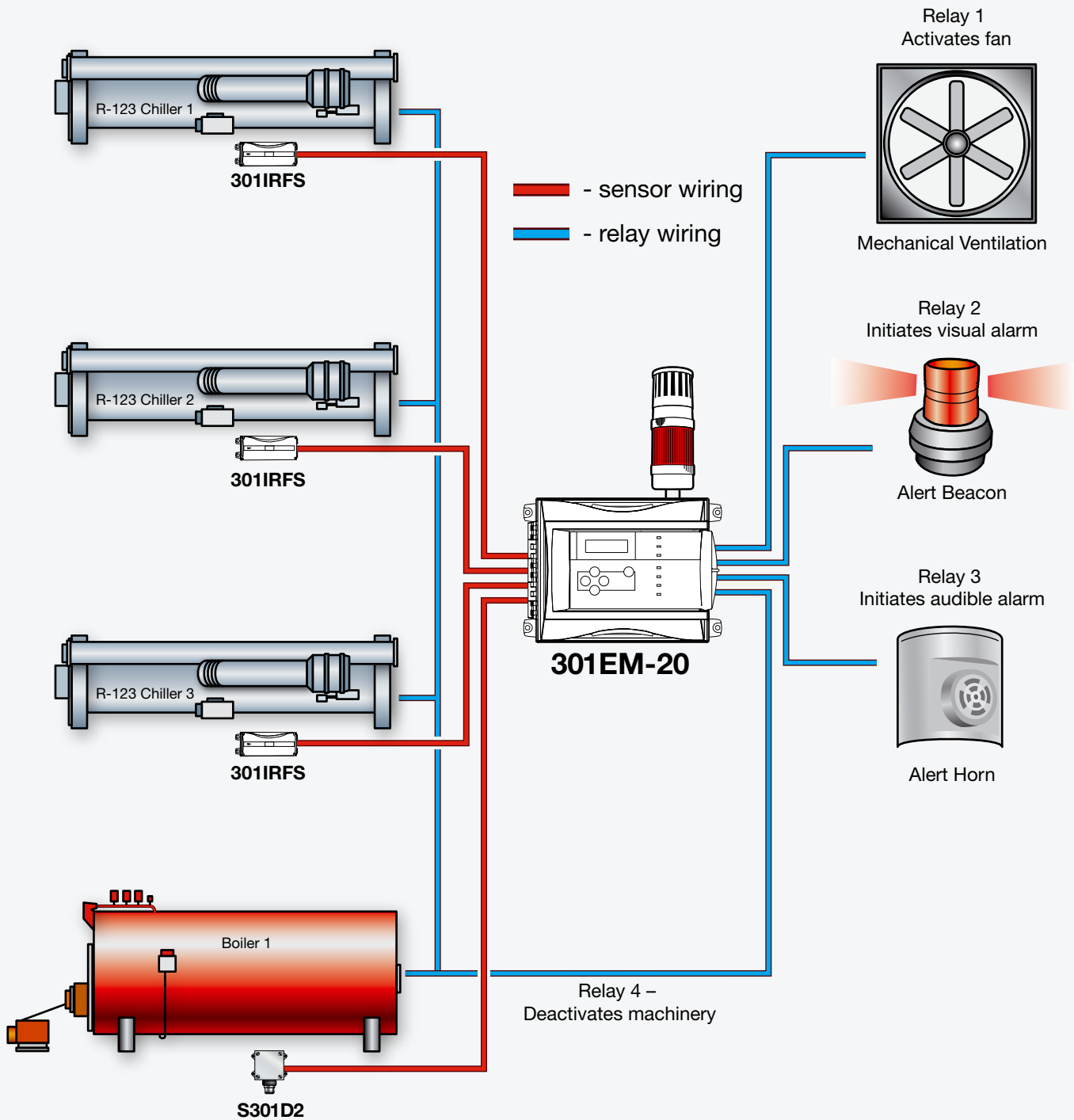

Mechanical Room Codes and Standards



This step-by-step guideline helps designers select an optimal monitoring system in order to provide a safe mechanical equipment room.

Mechanical Room Codes and Standards

Step 1: Determine the reason why you want to monitor gas in your mechanical room.

- Area monitoring: Applying stationary sensor(s) where permanent monitoring is required in mechanical equipment rooms.
- Leak pinpointing: This requires portable hand-held equipment to check for an individual leak(s) in refrigeration equipment (this document is not intended for leak pinpointing applications).
- Gas monitors satisfy the requirements for equipment room emissions included in EPA regulations.

Step 2: Be aware of the requirements of ASHRAE standard 15-2007 and applicable local building codes:

- Each machinery room shall contain a detector located where a refrigerant leak would concentrate.
- The detector shall trigger an audible and visual alarm both inside and outside the mechanical room and actuate mechanical ventilation. (See Table 1 for recommended alarm levels.)

- The detector shall shut down any combustion process in or near the mechanical room in the event of a refrigerant leak.
- A self-contained breathing apparatus (SCBA) is required. A second SCBA is recommended as a back-up. (See step 13 for details.)

Sequence of Operation

Step 3: Actuation of mechanical ventilation

The mechanical ventilation should be designed to meet the requirements of ASHRAE Standard 15-2007. Two distinct ventilation rates are defined for the mechanical equipment room (MER). The first is normal ventilation at a rate of 0.5 cfm per square foot (or more, if excessive heat is produced in the room), and is required whenever the MER is occupied; the second is the purge ventilation rate, and is based on the mass of refrigerant in the refrigeration system.

Step 4: Combustion process shutdown in the mechanical equipment room

As per ASHRAE Standard 15-2007: A refrigerant detector is employed to automatically shut down the combustion process in the event of refrigerant leakage. This only

applies when both boilers and chillers are in the same mechanical equipment room.

Step 5: Gas detection central panel and relay module

- Must be easily accessible and visible.
- Normally close to the main entrance door of the mechanical equipment room.
- Should be installed inside the mechanical equipment room.

Step 6: Self-test diagnostic and malfunction warning

- Not all monitors offer such features.
- Ensures refrigerant leak protection at all times.

Step 7: Output signals

- Alarm relay output: generally two are required (low- and high-level alarms).
- Failure relay output: only one required (indicates monitor failure).
- Analog output: one per type of refrigerant monitored (normally interlocked with BAS).

Mechanical Room Codes and Standards

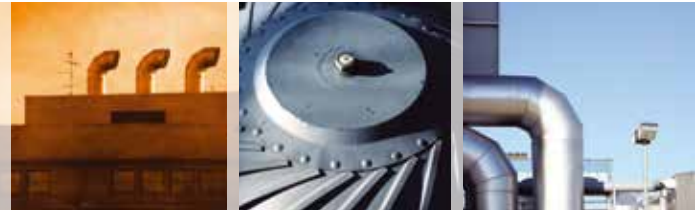

Sensors

Step 8: Locating sensors

The following considerations should be kept in mind when determining the location of the actual refrigerant sensor:

- 1) Determine the air flow pattern in the mechanical equipment room to:
 - a) see where a refrigerant leak may accumulate if areas of the chiller room air flow become stagnant, creating pockets where refrigerant vapors can concentrate.
 - b) locate the sensor in the air stream produced by the mechanical ventilation in the room. (See Figure 2.)
- 2) Remember that occupant safety is the primary motive for installing the sensor(s).

- 3) Recognize that occupants of the mechanical equipment room are most likely to be exposed to refrigerants through direct inhalation.

The quantity of sensors is generally governed by the following rules:

- 1) Consider a 20 ft. (6.1 m) radius per sensor – the sensor must be located within 20 ft. (6.1 m) of the chiller. (See Figure 3.)
- 2) There should be at least as many sensors in a given mechanical room as there are different types of refrigerants.
- 3) As refrigerants are heavier than air, monitor the presence of refrigerant in locations like pits, stairwells and trenches.
- 4) If possible, monitor the vent line of the chiller.
- 5) Remember to monitor the cylinder storage area if inside or near the

chiller room in case of cylinder leakage.

- 6) Remember, as per ASHRAE Standard 15-2007: locate the sensor where refrigerant is likely to concentrate.

After an optimal location is determined based upon the above recommendations, consider accessibility and maintenance issues. Sometimes a minor change in location of a sensor will enhance access with no detriment to functionality.

Step 9: Height of sensors

CFC-, HCFC- and HFC-based refrigerants are all heavier than air. It is recommended to locate the sensor module 18 inches above the floor.

Table 1 – Refrigerant data and suggested alarm levels

Prefix: "R" or...	No.	Chemical Name	Chemical Formula	1st Alarm Level Low	2nd Alarm Level High
CFC	11	Trichlorofluoromethane	CCl ₃ F	250 ppm ⁷	500 ppm ¹
CFC	12	Dichlorodifluoromethane	CCl ₂ F ₂	250 ppm ⁷	500 ppm ²
HCFC	22	Chlorodifluoromethane	CHClF ₂	250 ppm ⁷	500 ppm ³
HCFC	123	2,2-dichloro1,1,1-trifluoroethane	CHCl ₂ CF ₃	50 ppm ⁴	150 ppm ⁵
HFC	134A	1,1,1,2-tetrafluoroethane	CF ₃ CH ₂ F	250 ppm ⁷	500 ppm ⁶

- 1 - 50% of TWA, 8 Hr, PEL (OSHA) – Ceiling, TLV (ACGIH)
- 2 - 50% of TWA, 8 and 12 Hr, AEL (DuPont), WEEL (AIHA)
- 3 - 50% of TWA, 8 Hr, TLV (ACGIH)
- 4 - TWA, 8 Hr and 12 Hr, AEL (DuPont), WEEL (AIHA)

- 5 - Upon recommendation of DuPont
- 6 - 50% of TWA, 8 Hr and 12 Hr, AEL (DuPont), WEEL (AIHA)
- 7 - Early detection level

A broad range of other refrigerants can be detected. Alarm levels can be modified upon customer requirements.

Abbreviations:

ACGIH: American Conference of Governmental Industrial Hygienists
 AEL: Acceptable Exposure Limit
 AIHA : American Industrial Hygiene Association

OSHA: Occupational Safety and Health Administration
 TLV: Threshold Limit Value

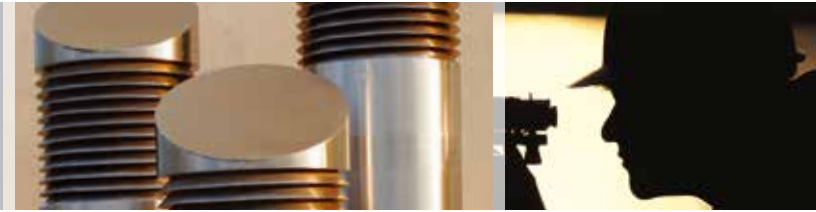
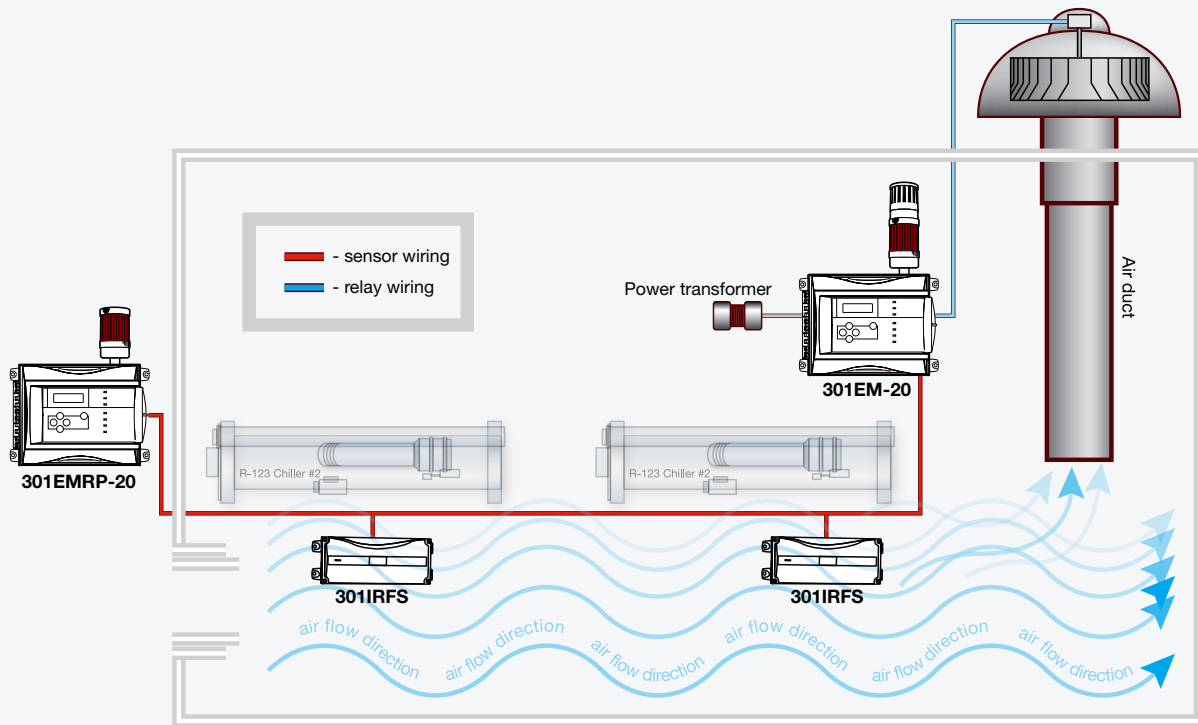

Figure 2 – Gas detection equipment location and airflow



Accessories

Step 10: Self-contained breathing apparatus (SCBA)

- SCBAs should be NIOSH-approved and contain the following:
 - 1) 30-minute aluminum cylinder (filled with breathing air), adjustable harness and backpack
 - 2) Face mask, whistle and pressure gauge with luminous face
 - 3) Medium pressure hose, first stage pressure regulator and positive pressure second stage regulator
- Avoid using NFPA-compliant SCBAs as they are made for firefighting
- As per ASHRAE Standard 15-2007: When a mechanical room is required per the rules of 7.4, at least one

approved self-contained breathing apparatus, suitable for the refrigerant used, shall be located outside of, but close to, the machinery room. A second, backup, self-contained breathing apparatus shall also be provided.

- SCBAs must be installed in dedicated wall mountable cases. (See Figure 4.)

Step 11: Warning signs

- Signs should be 12 to 16 in. (30 to 40 cm) square.
- Black engraved letters on white bond.
- They must designate and identify the meaning of all system status from visual and audible alarm devices. (See Figure 5.)

- They should be located close to every warning device.
- Warning signs should also be installed at each door entrance of the mechanical room.

Mechanical Room Codes and Standards



Figure 3 – Sensor location general guidelines

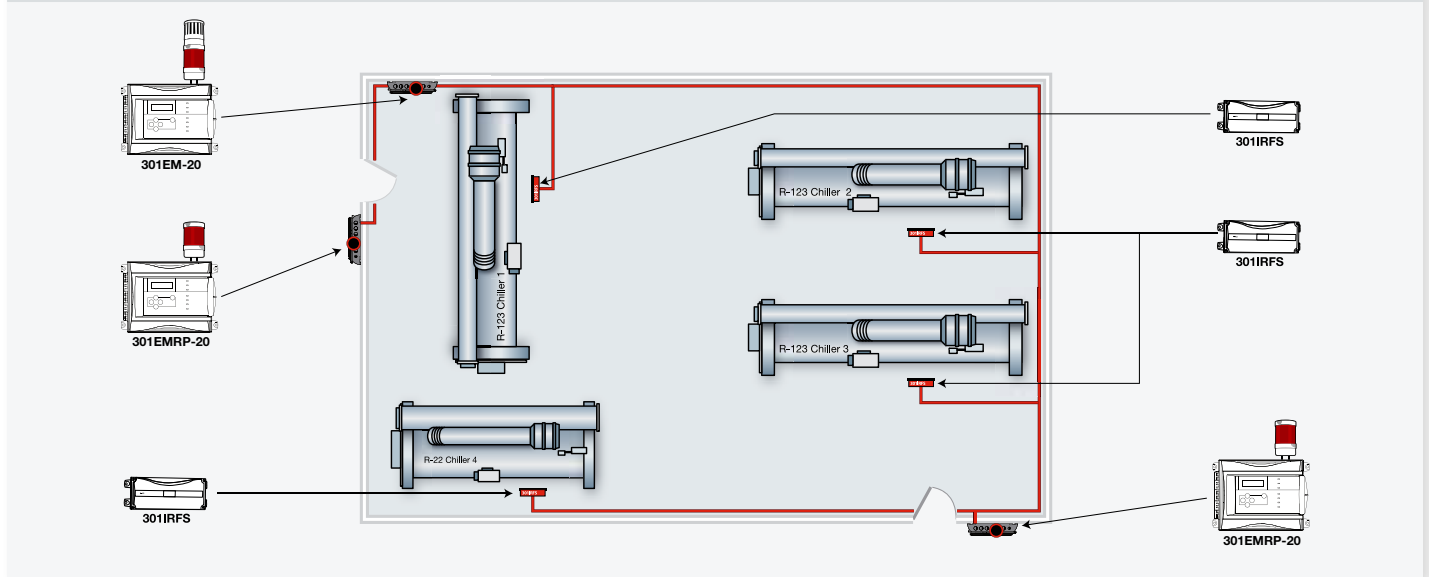

Closeout Procedures

Step 12: Demonstration and training

Utilize a factory-authorized service representative to train owner's maintenance personnel to adjust, operate, diagnose, calibrate and maintain the refrigerant monitoring system.

Step 13: Calibration

- Calibration intervals must comply with manufacturer's recommendations.
- Calibration kits should be provided on the delivery date of the gas detection system.
- Owner may consider using factory-authorized service representative to maintain and calibrate the gas monitoring system periodically.

Mechanical Room Codes and Standards



Figure 4 – Accessory layouts

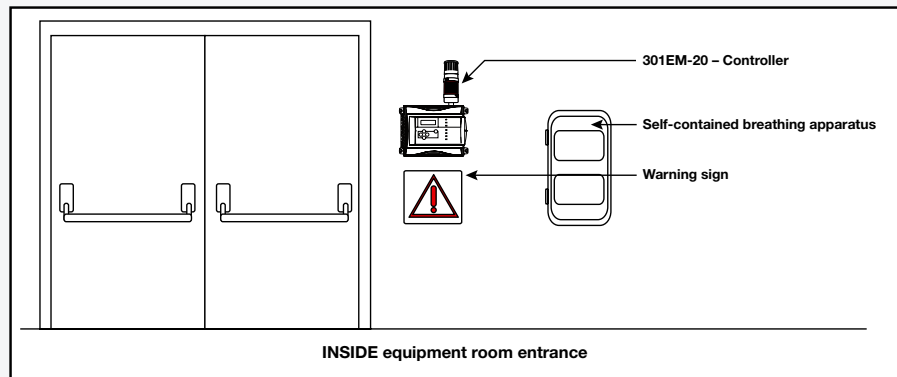
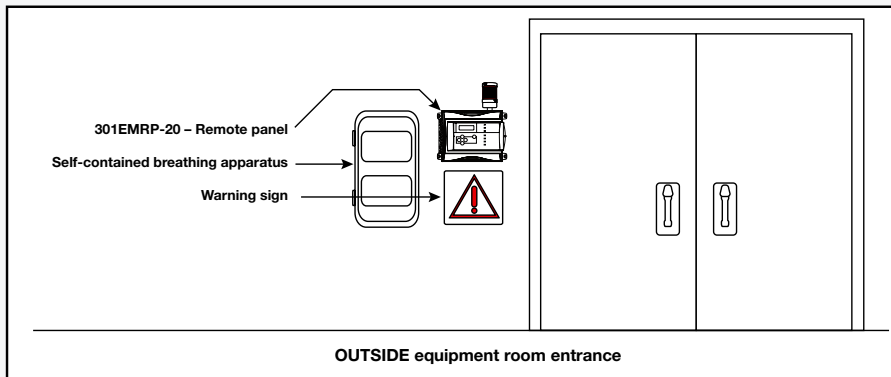

Figure 5 – Warning signs

INSIDE Mechanical Room

DANGER! **REFRIGERANT R123**

Leave room **IMMEDIATELY** when alarm sounds.

SIGN 1 to be installed close to the main entrance door inside the mechanical equipment room

OUTSIDE Mechanical Room

DANGER! **REFRIGERANT R123**

When alarm sounds, **DO NOT ENTER ROOM** without self-contained breathing apparatus.

SIGN 2 to be installed at each entrance door outside of the mechanical equipment room

The Complete Gas Detection System for Boiler Rooms



The toxic and combustible gases in boiler rooms are potentially dangerous and can undermine safety if leaks occur. Eliminate the guesswork with Honeywell Analytics' complete mechanical room solution.

A building's mechanical room is the hub of its heating, ventilation and air conditioning (HVAC) system. This can include central utility plants, boiler and chiller rooms, mechanical and electrical rooms and fuel rooms. The equipment within these rooms have the potential to leak harmful combustible or toxic gases, including costly and environmentally harmful refrigerant gases.

Boiler Room Monitoring

Monitor your mechanical room's boiler equipment to ensure an adequate supply of combustion air and to help reduce the build-up of a flammable gas concentration. Working as a stand-alone system or networkable to your existing equipment, compliance couldn't be more reliable.

301C

Controller



The 301C controller continuously monitors and controls toxic gases, combustible gases and oxygen hazards. Designed for installation and operational simplicity, the 301C reduces the cost of installation and ownership.

E³Point

Toxic, combustible & oxygen gas detector & transmitter



E3Point is capable of detecting the widest range of toxic and combustible gases found in commercial building spaces and outbuildings.

Sensepoint[®] XCD

Toxic, combustible & oxygen gas detector & transmitter



The Sensepoint XCD transmitter provides comprehensive monitoring of combustible, toxic and oxygen gas hazards in potentially explosive atmospheres — and is marked by installation ease and user-friendly operation.

Boiler Room Standard Installation



Boilers Standard Installation

Step 1: Ventilation

The prime objective for boiler room ventilation is to ensure an adequate supply of combustion air. It can also help reduce the build-up of a flammable gas concentration; however, this cannot be guaranteed, which is why gas detection systems are so widely used.

Step 2: Detection system

A gas detection system consists of a number of strategically located sensors hard wired to a control panel. Upon the detection of gas, alarm relay contacts within the control panel are used to activate audible and visual alarms. Should the gas concentration reach a higher level, a second set of contacts are used to remove the power to an electrically operated solenoid valve fitted to the gas supply line. (See Figure 6.)

Another option is to use gas sensors that provide an output suitable for direct interface to a Building Management System (BMS). The BMS then cuts the gas supply and switches off any potential ignition sources.

Step 3: Gas sensors

Catalytic Bead Sensors are less prone to false alarms than Solid State or Semi-Conductor sensors, which are affected by changes in ambient temperature and humidity. The best catalytic bead detectors are 'poison resistant' which offer a longer operational life, typically 3-5 years or more.

Gas fired boiler rooms are usually designated as a 'safe area' (i.e., not requiring hazardous area certified

equipment). However, it is considered good practice to use certified gas sensors to remove the possibility of the sensor being the source of ignition. This permits the operation of the gas sensors when all other potential ignition sources have been switched off at the second or higher alarm level.

Honeywell Analytics produces gas sensors certified to the latest Class I, Div. 1 or applicable regulations.

Step 4: Location of gas sensors

Natural gas is lighter than air; therefore, gas sensors should be located over potential leak areas. These include:

- The gas burner assembly
- The gas train assembly
- The pressure boosters (if fitted)
- The gas shutoff valve
- The combustion air intake
- The gas meter

On a small gas boiler installation a number of these points may be close together requiring a single point of detection. On installations using large shell type boilers (as in hospitals, factories or large blocks of flats), it may be necessary to install one detector over each of these areas.

Consideration must be paid to mechanical ventilation and its likely effect upon the path of leaking gas when locating a gas sensor.

For installations using Liquefied Petroleum Gas (LPG), which is heavier than air, gas sensors would need to be mounted near to the floor or in pipe and cable ducts.

Step 5: Location of control equipment

Most gas detection control panels are not certified for use in hazardous areas and should be mounted away from the gas installation, ideally outside the boiler room to ensure gas readings can be checked prior to entry.

Control panels are available in a number of mechanical configurations for ease of application, these include:

- Din rail mounting for inclusion within other plant control panels
- Wall mounting
- Rack mounting

An alternative power supply in the event of power failure is also good practice and battery back-up systems are also available.

References:

EN50073:1999 Guide for selection, installation, use and maintenance of apparatus for the detection and measurement of combustible gases or oxygen.

BS EN61779-1:2000 electrical apparatus for the detection and measurement of flammable gases – Part 1: General requirements and test methods.

EN60079 Series, Electrical Apparatus for use in explosive atmospheres.

Honeywell Analytics Lines of Business



Commercial

Gas detection from standalone units to fully engineered, multi-point systems, all offering cost-effective regulatory compliance

- » Applications: parking structures, chillers, mechanical rooms, office towers, commercial buildings, shopping centers, swimming pools, golf courses, schools and universities, laboratories

Industrial

Renowned Sieger and Manning gas detection systems with advanced electrochemical, infrared and open path sensing technologies

- » Applications: oil and gas, cold storage, water/wastewater treatment, chemicals, engine rooms, plastics and fibers, agriculture, printing and light industrial

Portables

Single or multi-gas Lumidor and other premium detectors with compact, lightweight designs ranging from simple alarm only units to advanced, fully configurable and serviceable instruments

- » Applications: underground utility and electricity ducts, boiler rooms, post-fire sites, sewers, industrial plants, industrial hygiene, first responder teams, remote fleets



High Tech/Government

A complete portfolio of gas and chemical detection instrumentation including infrared spectroscopy (MST) with no cross interference, to Chemcassette paper-based solutions (MDA Scientific) offering detection down to parts per billion

- » Applications: semiconductor manufacturing and nanotechnology, aerospace propulsion and safety, specialty chemicals industry, research laboratories, emergency response

Technical Services

24/7 global network includes post-sales service and Systems Integration teams

- » Emergency call out, service contracts, on/off-site repair, training and commissioning
- » Complete range of spares, consumables and accessories

Please Note:

While every effort has been made to ensure accuracy in this publication, no responsibility can be accepted for errors or omissions. Data may change, as well as legislation, and you are strongly advised to obtain copies of the most recently issued regulations, standards, and guidelines. This publication is not intended to form the basis of a contract.

APN068_v6 10/14

© 2014 Honeywell Analytics

Honeywell

1.800.561.8187

www.itm.com

information@itm.com