

# TRUE ECHO®

General Purpose  
CR-L Radar Liquid Level Sensor

## User Manual



Doc # 9006834

Part # 201120

Rev F2, 02/2026

1.800.561.8187

www.itm.com

information@itm.com

# CONTENTS

<b>INTRODUCTION</b>	III
<b>WARRANTY AND WARRANTY RESTRICTIONS</b>	IV
Repair and Returns	IV
<b>CHAPTER 1: DIMENSIONS AND WIRING</b>	1
Dimensions	1
Electrical Pinout and Power Supply Tables	2
Wiring Information	2
<b>CHAPTER 2: INSTALLATION AND REMOVAL PROCEDURES</b>	3
Physical Installation Notes	3
Tools Needed	3
Mounting Instructions	3
Sensor Placement	4
Removal Instructions	5
<b>CHAPTER 3: PROGRAMMING WITH THE APP</b>	6
Connect Short-Range Wireless Communication	6
Setting Descriptions	8
4-20 mA Specific Options	14
RS-485 Specific Options	15
<b>CHAPTER 4: MODBUS PROGRAMMING</b>	16
RS-485 (4-Wire) Units Only	16
<b>CHAPTER 5: APPLICATION EXAMPLES</b>	18
Water Tank Level Management (4-20 mA Output)	18
Flowing Water Level Management (4-20 mA Output)	19
<b>CHAPTER 6: MAINTENANCE</b>	20
General Care	20
<b>APPENDIX: BEAM ANGLE REFERENCE TABLE</b>	21



# INTRODUCTION

Thank you for purchasing a TRUE ECHO® CR-L Radar Liquid Level Sensor from APG. We appreciate your business! Please take a few minutes to familiarize yourself with your sensor and this manual.

The TRUE ECHO CR-L radar is a Frequency Modulated Continuous Wave (FMCW) radar operating at 76-81 GHz. It has a maximum measuring range of 49.2 feet (15 m) and a minimum blind zone of 7.87 inches (0.2 m). The TRUE ECHO CR-L brings the accurate level readings of radar sensors to industrial liquid measurements. It can accurately measure in many adverse environments. Its narrow beam can detect small targets and achieve precise positioning with high resolution. All TRUE ECHO CR-L sensors can be easily setup and field adjusted via the TRUE ECHO app.

## Reading your label

Every TRUE ECHO sensor comes with a label that includes the instrument's part number, model number, and serial number. Please ensure that the part number on your label matches your order.

## Key Features

- Accurate level measurements in various adverse environmental conditions.
- Millimeter wave technology allows higher signal-to-noise ratio and smaller blind zone.
- The 4° antenna beam half angle means the environmental interference has less impact on the sensor and the installation is more convenient.
- Integrated design, small size.
- Chemical resistance
- 4-20 mA (2 wire), and RS-485 (4 wire) outputs.
- Short-Range wireless communication to facilitate on-site personnel maintenance work.

IMPORTANT: FCC regulations require 75-85 GHz radars to be installed to ensure a vertically downward orientation at fixed locations only. They must not operate while being moved or while inside a moving container. Hand-held applications are prohibited as well as marketing to residential consumers.

## WARRANTY AND WARRANTY RESTRICTIONS

This product is covered by APG's warranty to be free from defects in material and workmanship under normal use and service of the product for 24 months. For a full explanation of our Warranty, please visit [apgsensors.com/warranty-returns](http://apgsensors.com/warranty-returns). Contact Technical Support to receive a Return Material Authorization before shipping your product back.

### Repair and Returns

Should your TRUE ECHO Radar require service, please contact the factory via phone, email, or online chat. We will issue you a Return Material Authorization (RMA) number with instructions. You can also find the form on our website by clicking "RMA" in the web footer

# CHAPTER 1: DIMENSIONS AND WIRING

## Dimensions

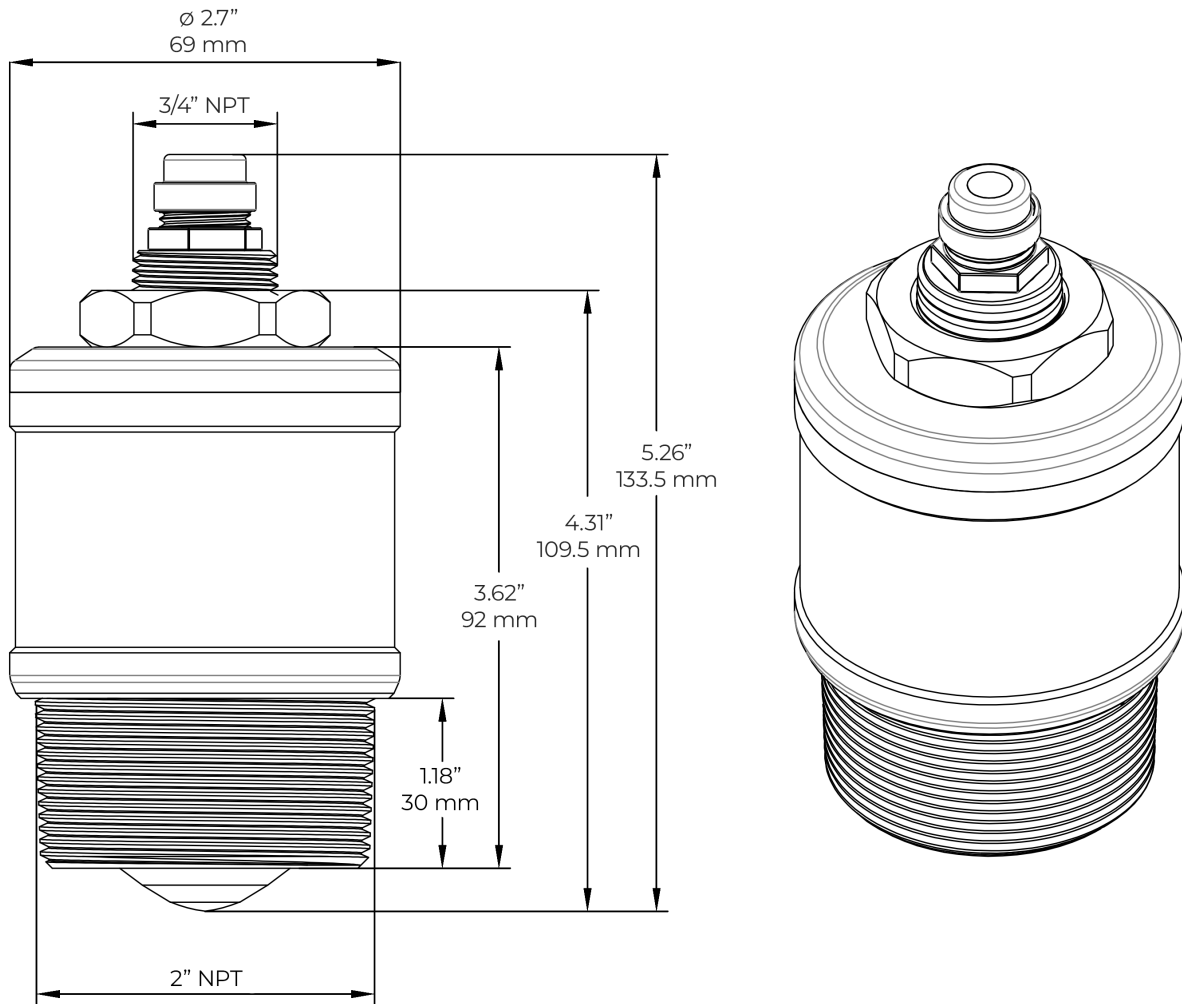

*TRUE ECHO CR-L General Purpose Radar*

# Electrical Pinout and Power Supply Tables

## Pin Out Tables

	<b>4-20 mA</b>
Red	Power Supply + 12 to 28 VDC
Black	4-20 mA Out
Yellow	Shield, Earth Ground

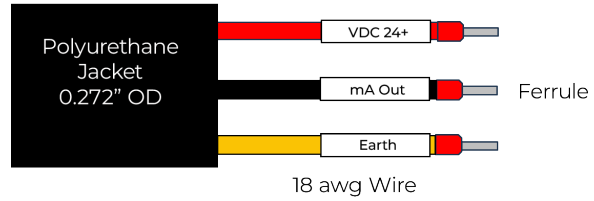

	<b>RS-485</b>
Red	Power Supply + 12 to 28 VDC
Black	Power Supply Ground -
Blue	RS-485 A+
White	RS-485 B-
Yellow	Shield, Earth Ground

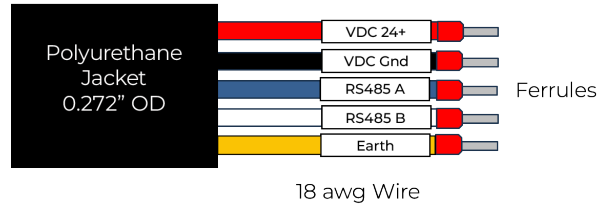

## Wiring Information

### Power Supply Table

Output	Voltage	Typical RMS Current	Peak Current 3.3ms Pulse Every 1sec Update Cycle
4-20 mA	12-28 VDC	4-20 mA	n/a
RS-485	12-28 VDC 24 VDC 12 VDC	— 9-12 mA 14.5-17.6 mA	— 145 mA 234 mA

#### 4-20 mA Connection:

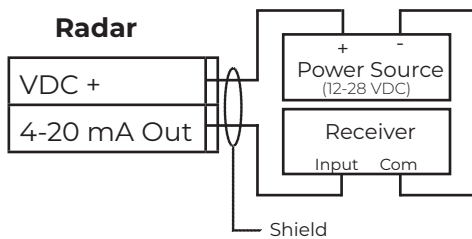

#### RS-485 Connection:

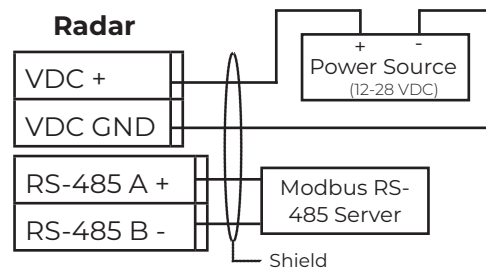

NOTE: Connect Shield wire to Power Supply Earth Ground.

# CHAPTER 2: INSTALLATION AND REMOVAL PROCEDURES

## Physical Installation Notes

- The material to be measured must have a dielectric constant greater than 2.
- In areas with direct sunlight, it is recommended to install the instrument in a cool place or use a sun visor to avoid excessive temperature and to provide good ventilation and heat dissipation.
- Mount your TRUE ECHO sensor so that it has a clear, perpendicular path to the surface being monitored.
- Install at least 8 inches from a side wall.
- The radar path should be free from obstructions and as open as possible for the 4° off axis beam pattern. Mount the sensor away from tank or vessel inlets.
- Wrap PTFE tape around threads before installing the radar into the tank opening. This will help it screw in easier. **Do not over tighten.**
- For proper performance and accuracy, do not suspend by cable without the use of the optional weight.
- Be careful not to scratch or damage the radar face.

## Tools Needed

- Tools to make electrical connection
- Mobile device with short-range wireless communication

## Mounting Instructions

- STEP 1:** Mount the radar using the 2 inch NPT bottom threads or the 3/4 inch NPT top threads and nut. **Do not over tighten.** If suspending the radar by the cable, use the 316SS weight accessory.
- STEP 2:** Attach the wires to your control system according to the Wire Diagrams on page 2.
- STEP 3:** Power on the radar. The radar will take the level reading within 6 seconds.
- STEP 4:** Use the TRUE ECHO app to connect to the radar via short-range wireless communication. See “Programming with the App” on page 6 for more information.



## Sensor Placement

Ensure the radar level transmitter is installed **perpendicular** to the liquid surface. Installing the radar at an angle will weaken the signal amplitude, cause unwanted reflections, and affect the normal range.

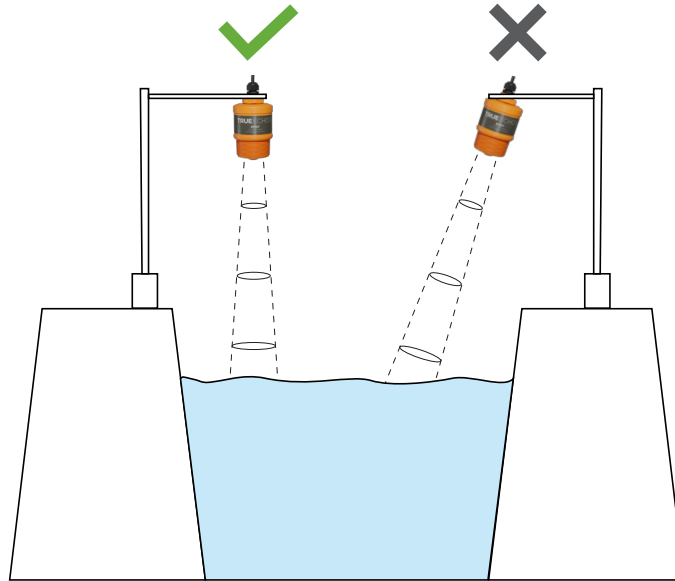

*Position radar perpendicular to surface.*

Ensure that there are no interferences within the beam angle, such as riverbanks, tank walls, ladders, steps, etc.

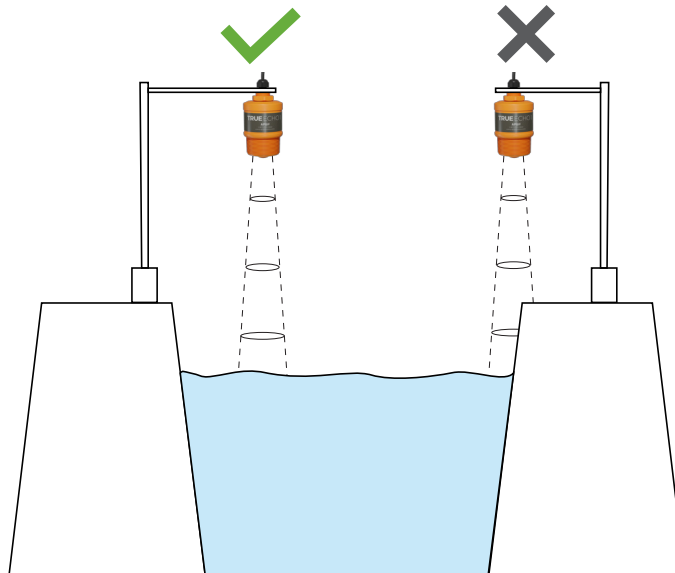

*Ensure no interference in the beam angle.*

Install the radar at least 7.9 inch (20 cm) away from side walls. When installing in wells or pipes, place the radar as close to the center as possible to avoid interference from the walls.

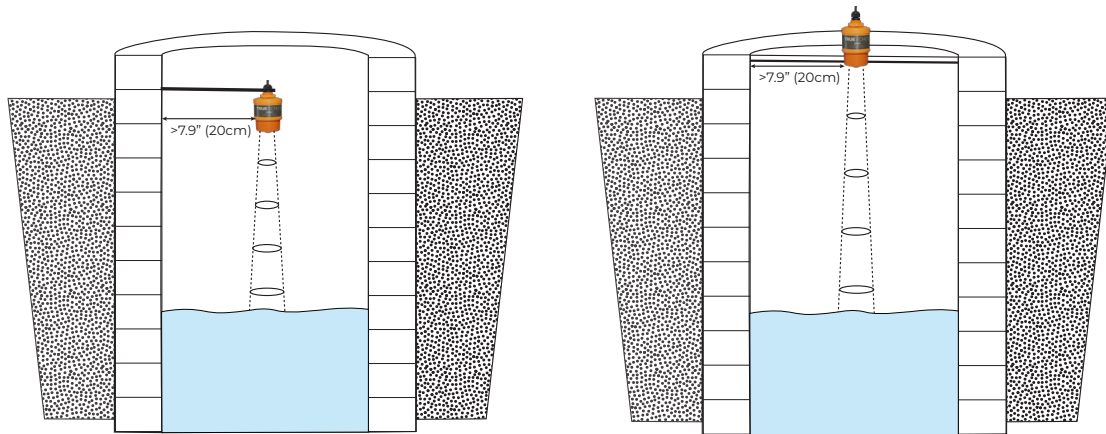

*Install radar away from walls in wells and pipes.*

When installing in tanks with domed lids, install off center to avoid additional false echoes.

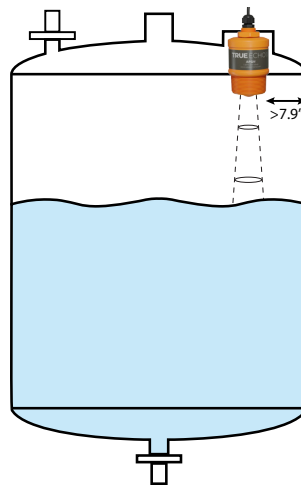

*Install radar off center in domed tanks, at least 7.9" away from side walls.*

## Removal Instructions

Removing your radar from service must be done with care.

- STEP 1:** Ensure power is turned off.
- STEP 2:** Disconnect the radar wires.
- STEP 3:** Remove the radar from its mount.
- STEP 4:** Store it in a dry place, at a temperature between -40° to 158°F (-40° to 70°C).

# CHAPTER 3: PROGRAMMING WITH THE APP

All TRUE ECHO radar sensors are compatible with our TRUE ECHO app. To change settings and parameters easily with your mobile device, download the free TRUE ECHO Radar App by searching “TRUE ECHO” in the Apple or Google Play Store.



TRUE ECHO app logo

## Connect Short-Range Wireless Communication

- STEP 1:** Install the TRUE ECHO app from the app store.
- STEP 2:** Open the TRUE ECHO app. On the Select Device screen, press “Liquid Level Sensor.”
- STEP 3:** Each radar’s wireless communication name is displayed with either its Level and Current for 4-20 mA units or its Level and Modbus Address for RS-485 units. Press the radar’s name to access it.
- STEP 4:** Enter the password. The factory default password is **000000**. This can be changed in the app settings.

NOTE: When opening the app for the first time after installation, the app will prompt users to accept the Privacy Policy and will request Location and Relative Position permissions. These permissions are required to connect to the radar.

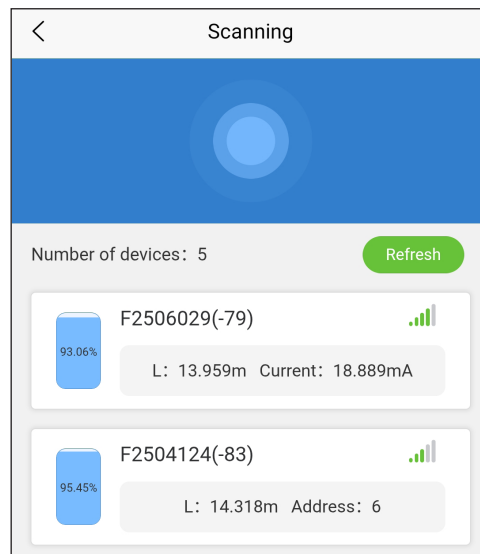
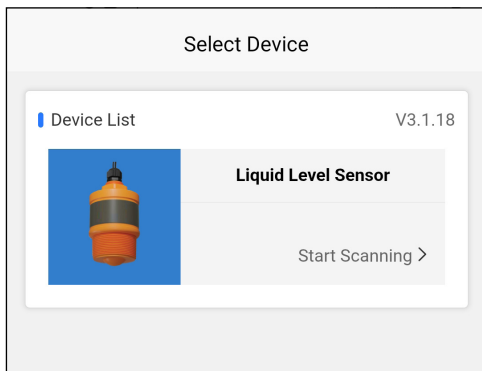

NOTE: If you don't see the device on the scanning screen, make sure the radar is wired correctly and powered on. Press “Refresh” to scan for devices.

The message “Reading all Settings” will be seen while the radar parameters are loaded into the app.

**Distance:** Distance from face of sensor to the target

**Level:** Range minus Distance

**Reliability:** Signal Strength

### 4-20mA App Menu

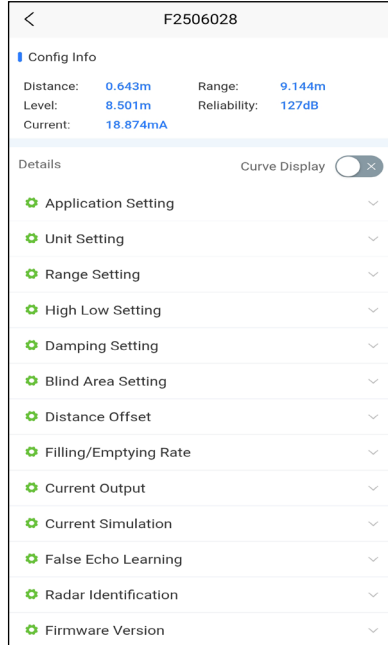

Press “Details” to see setting values

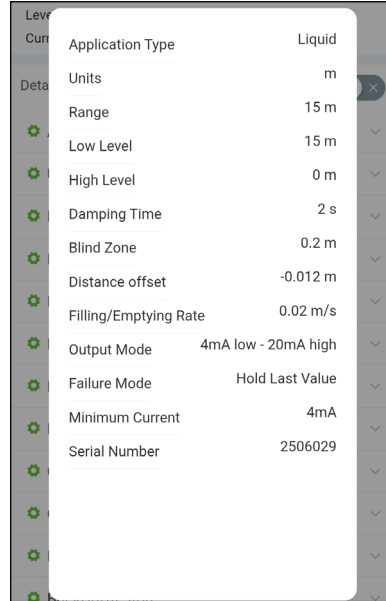

### RS-485 App Menu

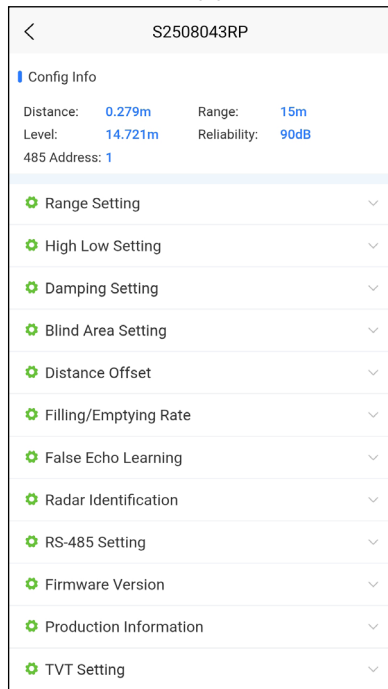

Press “Details” to see setting values

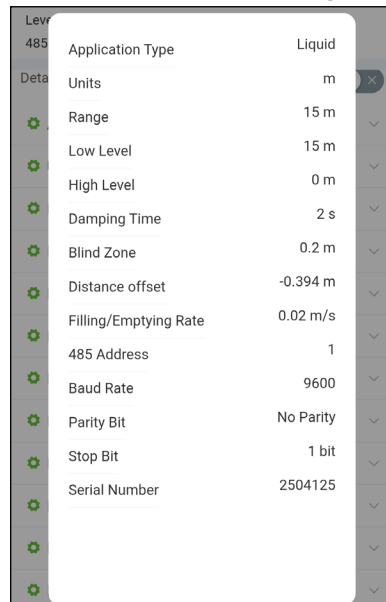

## Setting Descriptions

**Curve Display** is used to view the Echo Curve Graph. This is a visual representation of the echoes the radar is sensing from the target.

The vertical axis is the echo strength in dBs. The horizontal axis is the distance range in the selected unit starting at the sensor face at 0.

The green line is the echo curve and the red line is the threshold curve. The blue vertical line is the distance location of the current reading.

Use the *Curve Display* to validate the radar is sensing the target correctly during installation and setup.

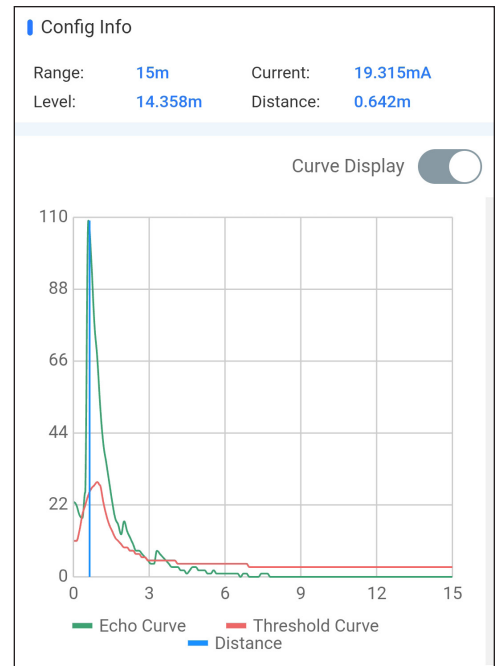

Press "Read" to view the current settings in each tab. Press "Write" to save changes.

## Application Setting

**Application Setting** selects the measuring application. The CR-L TRUE ECHO radar is best suited to measure liquids.

Options:

- Solid (Use for large solids. Not recommended for small particle bulk solids)
- Liquid (default)
- Demo (quick responses for demonstrations)

## Unit Setting

**Unit Setting** selects the displayed units in the app and RS-485 output.

Options:

- mm (millimeters)
- cm (centimeters)
- m (meters) (default)
- in (inch)
- ft (feet)

## Range Setting

**Range Setting** sets the maximum distance the sensor will look for a target measured from the sensor zero reference point. Typically, *Range* is set at or a little beyond the desired measuring range to achieve a fast and stable measurement and avoid false echoes.

- Range: 0.2 to 15 m (0.656 to 49.213 ft)
- Default: 15 m (49.213 ft)

## High and Low Setting

**Low Level** sets the **furthest** distance to be measured from the sensor zero reference point to the lowest point of the tank. *Low Level* must be less than or equal to the sensor *Range*. For 4-20 mA sensors, the *Low Level* will define either the 4 mA or 20 mA point (determined by *Current Output Mode* setting).

- Range: 0.2 to 15 m (0.656 to 49.213 ft)
- Default: 15 m (49.213 ft)

High and Low Setting	
*Low Level	15 m
*High Level	0 m

Read Write

**High Level** sets the **closest** point to be measured from the sensor zero reference point to the max fill point in the tank. The *High Level* value must be less than the *Low Level* value. For 4-20 mA sensors, the *High Level* will define either the 20 mA or 4 mA point (determined by the *Current Output Mode* setting).

- Range: 0 to 15 m (0 to 49.213 ft)
- Default: 0 m

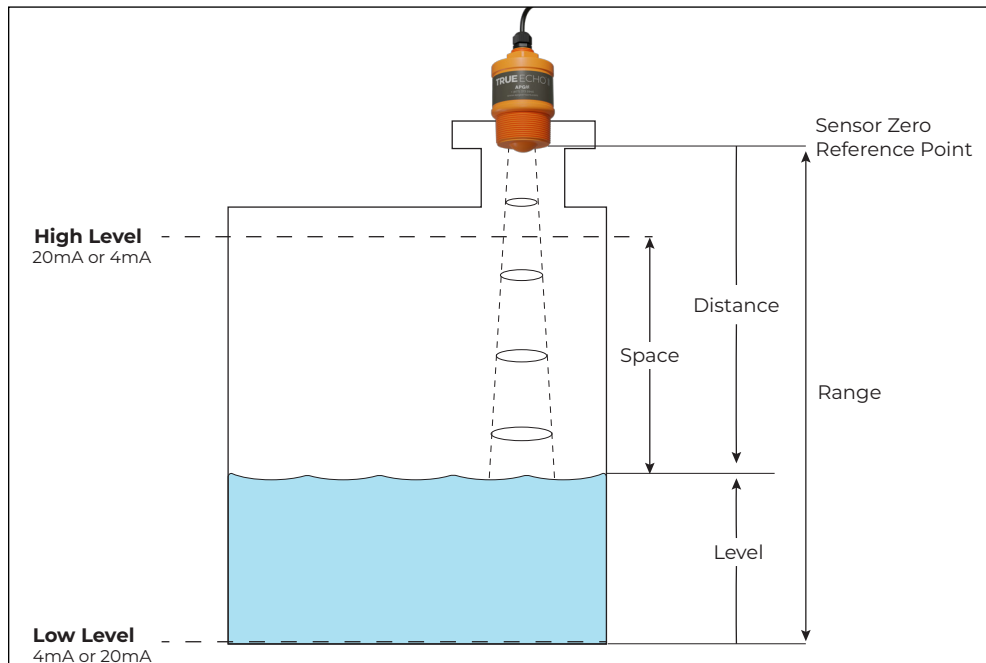

## Damping Setting

**Damping Setting** sets the time that is applied to a filter used to smooth sudden changes in the liquid level. A longer *Damping* time will provide more smoothing. A shorter *Damping* time will provide a quicker response with less stability in agitated conditions that may be undesirable.

- Range: 0 to 100 seconds
- Default: 2 seconds

If Damping is greater than 0 the following damping filter is applied:

$$D_{t+1} = \left[ D_t + \frac{(D_{target} - D_t)}{k} \right]$$

Where...  $D_{t+1}$  = Distance at the next second

$D_t$  = Current distance

$D_{target}$  = Target distance (distance without damping)

$k$  = Damping factor

In other words:

**New Damped Level = Current Damped Level + ((Current Level - Current Damped Level)/Damping)**

The following graph shows the smoothing applied with the *Damping* = 2 (default).

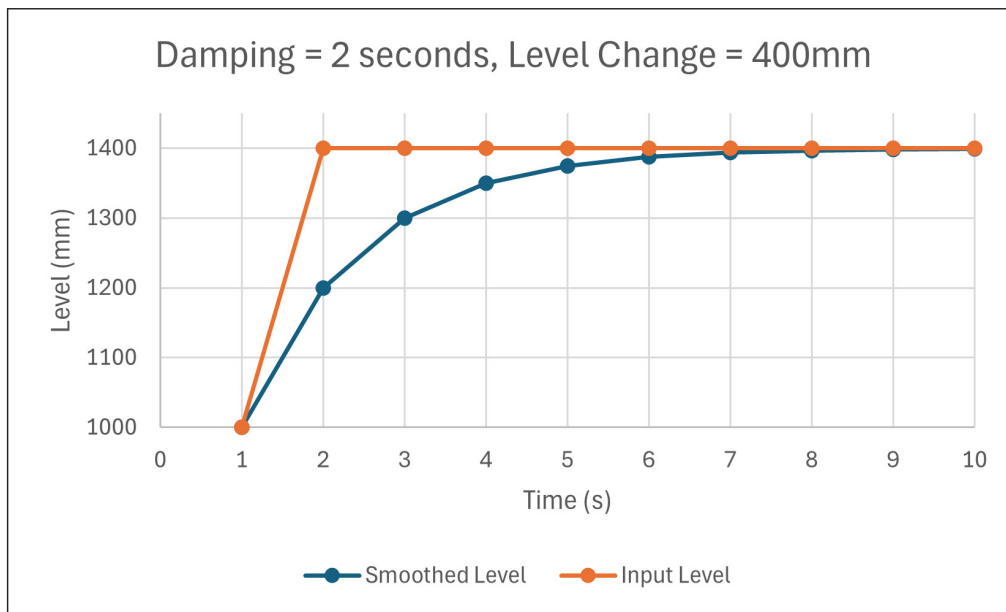

## Blind Area Setting

**Blind Area Setting** defines the distance in front of the sensor where it will not look for a valid target. Typically, it is set a little less than the closest liquid level to achieve a fast and stable measurement.

- Range: 0.2 to 15 m (0.656 to 49.213 ft)
- Default: 0.2 m (0.656 ft)

NOTE: The *Blind Area* and *Range* determine the processing bounds of the application. They should be set to avoid interference and false echoes and to achieve a fast and stable measurement.

## Distance Offset

**Distance Offset** positions the zero reference point of the sensor to be at the bottom of the NPT threads as indicated by point **A** in the figure to the right. It can also be used to offset the sensor reference point as needed.

- Range:  $\pm 0.3$  m (0.98 ft)
- Default: Calibrated at factory

To adjust the reference point to point **B**, enter the distance between points **A** and **B** as a negative value. If **A** is -0.197 ft and the desired reference point **B** is 1 foot in front of the sensor face, enter -1.197 ft.

To adjust the reference point to point **C**, enter the distance between points **A** and **C** as a positive value. If **A** is -0.197 ft and the desired reference point **C** is 1 foot behind the face, enter 0.803 ft.

**Note:** Some digital keyboards do not include a minus ( - ) key. A different digital keyboard may be needed to enter negative values.

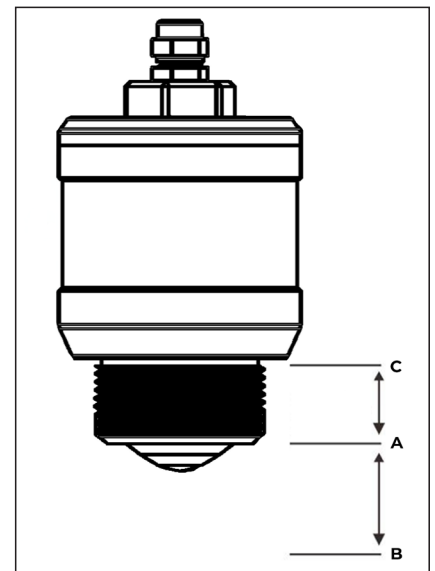

## Filling/Emptying Rate

**Filling/Emptying Rate** is used to adjust the response rate for tracking the actual liquid level change rate. Set it a little faster than the actual filling and emptying rate.

- Range: 0.001 to 0.05 m/s (0.003 to 0.164 ft/s)
- Default: 0.02 m/s (0.066 ft/s)

## False Echo Learning

**False Echo Learning** is used to manually mask out unwanted false echoes, usually caused by obstacles in the tank. Set the *Start* value to before the false echo. Set the *End* value to after the false echo.

- Range: 0 to 15 m (0 to 49.213 ft)
- Default: 0 (no masks)

**Note:** Multiple false echo masks can be applied. To delete all masks, press the False Echo Clear “Delete” button.

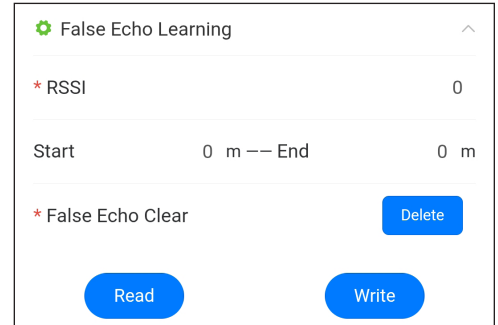

RSSI (Received Signal Strength Indicator), is used to increase the amplitude of each of the defined masks. This allows for amplitude fluctuations of the unwanted echo. Typically RSSI is left at zero.

No False Echo Mask applied

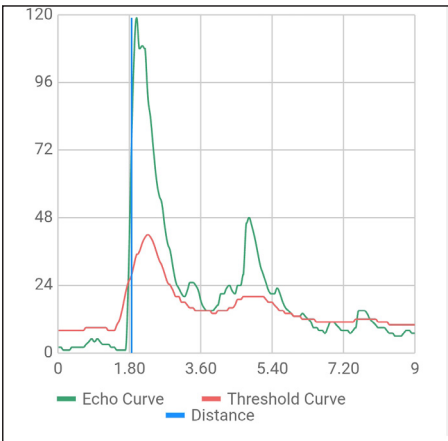

False Echo Start = 3.6 m  
False Echo End = 6.0 m  
RSSI = 0

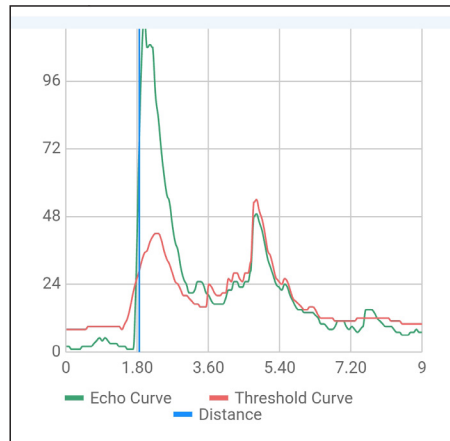

False Echo Start = 3.6 m  
False Echo End = 6.0 m  
RSSI = 5

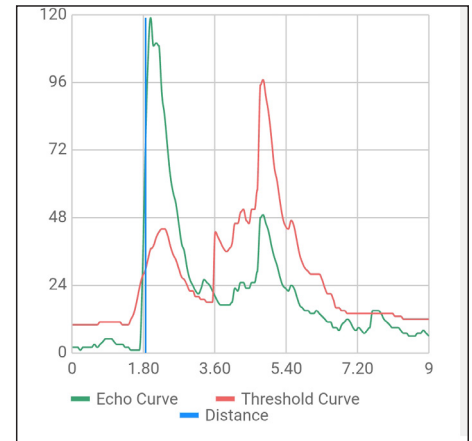

**NOTE:** The threshold curve will mask out low level background noise and defined false echoes.

## Radar Identification

**Radar Name** allows the 12-character radar name to be changed. Exit and re-enter the App to see the modified name. The radar Password must be entered to make this change.

**Radar Password** allows the 6-digit password to be changed from the factory default password 000000. The new password will be required the next time the app is opened. Entering an incorrect password will close the app.

**NOTE:** If the radar password is forgotten, contact APG for help. Please have the unit's serial number (located on the label) available.

## Firmware Version (Factory Use Only)

**Firmware Version** shows the electronics firmware version.

## Production Information (Factory Use Only)

**Production Date** shows the unit's production date.

**Serial Number** shows the numerical part of the factory serial number.

## TVT Setting

**TVT Margin** is used to change the threshold curve level (red line on the curve graph). All echoes below the threshold will be masked out.

- Range: 0 to 100
- Default: 15



TVT Setting: 15

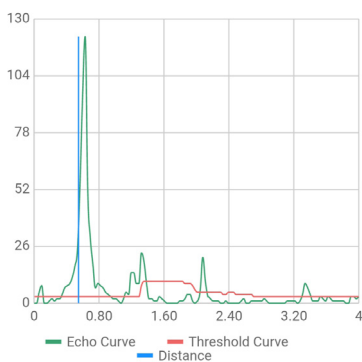

TVT Setting: 30

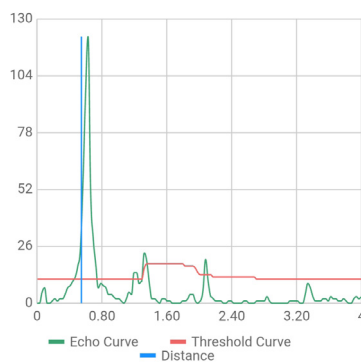

TVT Setting: 50

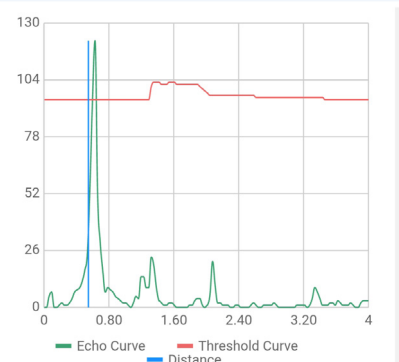

## 4-20 mA Specific Options

### Current Output

**Current Output** is used to define the mA values at the Low and High settings.

Options:

- 4 mA low - 20 mA high (default)
- 20 mA low - 4 mA high

**Failure Mode** is used to define the output level when a loss of echo or a fault occurs.

Options:

- Hold Last Value (default)
- 20.5 mA
- 22 mA
- 3.9 mA
- 3.8 mA
- 4 mA
- 20 mA
- 3.6 mA

**Minimum Current** is used to define the lowest current output during normal operations.

Options:

- 4 mA (default)
- 3.9 mA

Current Output	
Output Mode	4mA low - 20mA high
Failure Mode	Hold Last Value
Minimum Current	4mA

Read Write

### Current Simulation

**Current Simulation** allows the user to temporarily output a specific mA value for system testing. The output will return to a normal level when the “exit” button is pressed.

- Range: 3.600mA to 22.000mA
- Resolution: 0.001mA

Current Simulation	
Current Simulation	0 mA Set
* Simulation exit	exit

## RS-485 Specific Options

### 485 Setting

Using short-range wireless communication to change the RS-485 settings simplifies installation as units do not have to be isolated to change the Bus Address, Baud Rate, Parity Bit, and Stop Bit settings. See Chapter 4: Modbus Programming for more information about RS-485 programming.

**485 Address**, also known as Bus Address.

- Options: Address 1 to 247
- Default: Address 1

**Baud Rate:**

- Options: 1200, 2400, 4800, 9600, 14400, 19200, 38400, 56000, 115200, 156000, 460800, 500000, 51200, 600000, 750000, 921600, 1000000, 150000, 200000
- Default: 9600

**Parity Bit:**

- Options: No Parity, Odd Parity, Even Parity
- Default: No Parity

**Stop Bit:**

- Options: 1 bit, 1.5 bits, 2 bits
- Default: 1 bit

# CHAPTER 4: MODBUS PROGRAMMING

## RS-485 (4-Wire) Units Only

TRUE ECHO Radar sensors use standard RS-485 Modbus RTU protocol. The sensors can only operate as server devices. Sensor default transmission settings are 9600 Baud, 8 Bits, 1 Stop Bit, No Parity, and require a minimum delay of 100 ms between transactions. The default Modbus ID = 1.

For explanations about specific settings, go to Chapter 3: Programming with the App.

Modbus communication may override short-range wireless communication. Using both simultaneously may result in slower app response times.

### Read Input Registers 3x (Function Code 04)

<b>Modbus Register</b>	<b>Data Type</b>	<b>Function</b>
0000	Uint, 16	Distance (cm)
0001	Uint, 16	Distance (mm)
0002	Uint, 16	Level (cm)
0003	Uint, 16	Level (mm)
0036	Float 32, CDAB	Space (selected units)
0038	Float 32, CDAB	Level (selected units)
0040	Float 32, CDAB	Distance (selected units)

## Read Holding Registers 4x (Function Code 03)\*

Modbus Register	Data Type	Function	Value Range	Default
0062	Hex, 16 bit	Application Type	0000: Solid 2000: Liquid 4000: Demo	2000: Liquid
0063	Hex, 16 bit	Unit Setting	0000: Millimeter 0800: Centimeter 1000: Meter 1800: Inch 2000: Feet	1000: Meter
0064	Float 32, CDAB	Damping Setting	0 to 100 seconds	2 seconds
0066	Float 32, CDAB	Blind Zone Setting	0 to 15 meters	0.2 meters
0068	Float 32, CDAB	Range Setting	0 to 15 meters	15 meters
0070	Float 32, CDAB	High Level Setting	0 to 14.9 meters	0 meters
0072	Float 32, CDAB	Low Level Setting	0 to 15 meters	15 meters
0080	Float 32, CDAB	Distance Offset	15 to -15 meters	0 meters
0096	Float 32, CDAB	Filling/ Emptying Rate	0.001 to 0.1 meter/ second	0.002 meter/ second
0098	Float 32, CDAB	FalseEchoLearn, Start	0 to 15 meters	0 meters
0100	Float 32, CDAB	FalseEchoLearn, End	0 to 15 meters	0 meters
0108	ASCII Hex,	Radar Name	2F to F2	See Radar Label. i.e. F2504125
0109	Swap		05 to 50	
0110	Characters		14 to 41	
0111			52 to 25	
5121	Hex, 16	Factory Reset	0001	0
5893	Uint, 16	Baud Rate	0 = 1200 1 = 2400 2 = 4800 3 = 9600 4 = 14400 5 = 19200 6 = 38400 7 = 56000 8 = 115200 9 = 256000	3 = 9600
5894	Uint, 16	Address	1-247	1
5895	Hex, 16	Parity	High 8 bits 0 = None 1 = Odd 2 = Even	None
		Stop Bit	Low 8 bits 0 = 1 bit 1 = 1.5 bits 2 = 2 bits	1

\*NOTE: Use Write Function Code 16. Write Function Code 6 is not supported.

# CHAPTER 5: APPLICATION EXAMPLES

## Water Tank Level Management (4-20 mA Output)

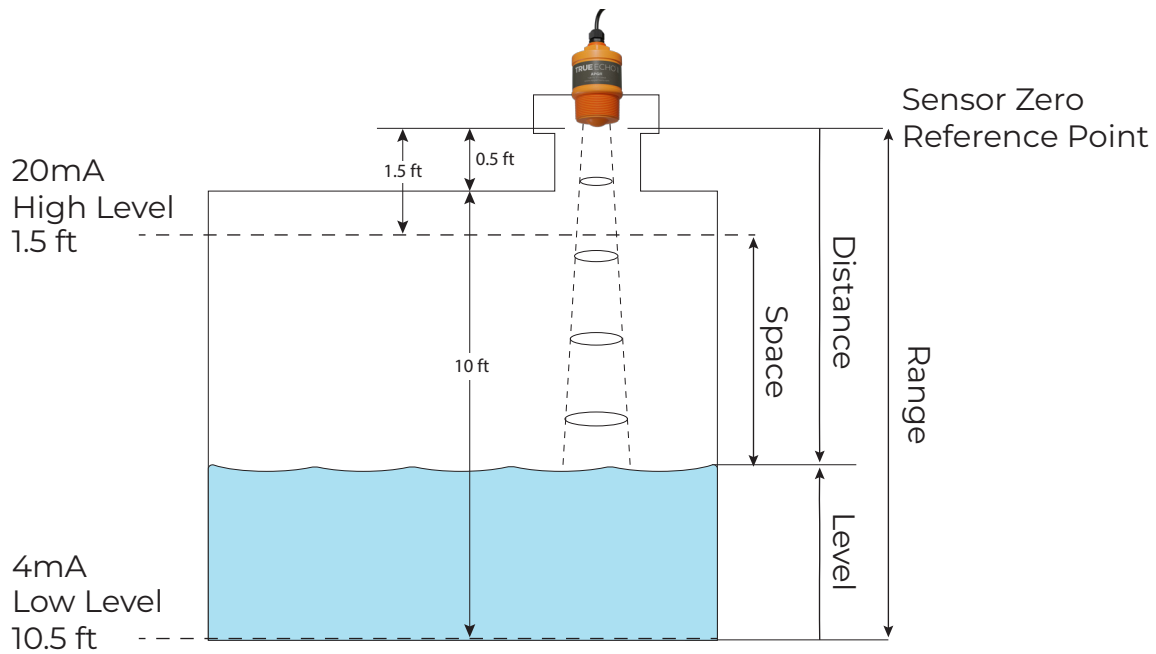

Water tank example

### General Setup

Setting	Value	Details
Application Setting	Liquid	Default setting
Unit Setting	Ft	
Range Setting	10.5 ft	Low Level
High/Low Setting		
Low Level	10.5 ft	Sensor zero ref to desired lowest measured point
High Level	1.5 ft	Sensor zero ref to desired highest measured point
Damping Setting	2 s	Default Value (increase if ripples cause spikes)

### 4-20 mA Specific Setup

Current Output		
Output Mode	4 mA Low, 20 mA High	Default Setting (4 mA at 10.5 ft, 20 mA at 1.5 ft)
Failure Mode	Hold Last Value	Default Setting

## Flowing Water Level Management (4-20 mA Output)

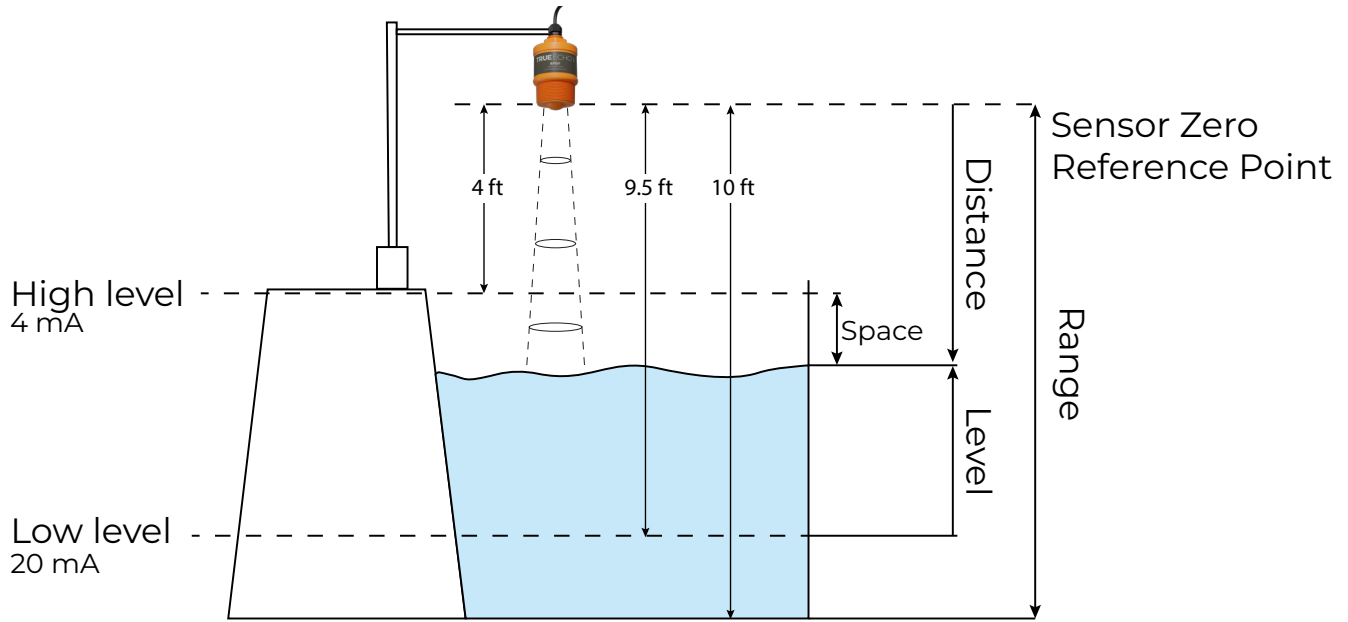

Flowing water example

### General Setup

Setting	Value	Details
Application Setting	Liquid	Default setting
Unit Setting	Ft	
Range Setting	10 ft	Lowest Measurable Point
High/Low Setting		
Low Level	9.5 ft	Sensor zero ref to desired lowest measured point
High Level	4 ft	Sensor zero ref to desired highest measured point
Damping Setting	2 s	Default Value (increase if ripples cause spikes)

### 4-20 mA Specific Setup

Current Output		
Output Mode	20 mA Low, 4 mA High	20 mA at 9.5 ft, 4 mA at 4 ft
Failure Mode	Hold Last Value	Default Setting

# CHAPTER 6: MAINTENANCE

## General Care

Your radar is very low maintenance and will need little care as long as it is installed correctly. However, in general, you should:

- Avoid applications for which the sensor was not designed, such as extreme temperatures, contact with incompatible corrosive chemicals, or other damaging environments.
- Inspect the threads whenever you remove the sensor from duty or change its location.

# APPENDIX: BEAM ANGLE REFERENCE TABLE

The CR-L General Purpose Radar has a 4° half angle beam. The diameter of the measuring spot can be calculated using:

$$\text{Distance} * \tan(4) * 2$$

Distance (ft)	Diameter of measuring spot (ft)
1	0.140
2	0.280
4	0.559
6	0.839
8	1.119
10	1.399
12	1.678
14	1.958
16	2.238
18	2.517
20	2.797
22	3.077
24	3.356
26	3.636
28	3.916
30	4.196
32	4.475
34	4.755
36	5.035
38	5.314
40	5.594
42	5.874
44	6.154
46	6.433
48	6.713
49.213	6.883

Distance (m)	Diameter of measuring spot (m)
1	0.140
2	0.280
3	0.420
4	0.559
5	0.699
6	0.839
7	0.979
8	1.119
9	1.259
10	1.399
11	1.538
12	1.678
13	1.818
14	1.958
15	2.098

