

User manual
mA Loop Calibrator
Jofra mAcal

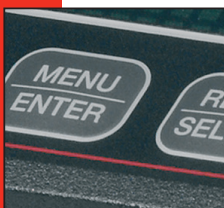

User Manual
mAcal
mA loop Calibrator
© Copyright 2005 AMETEK DENMARK A/S



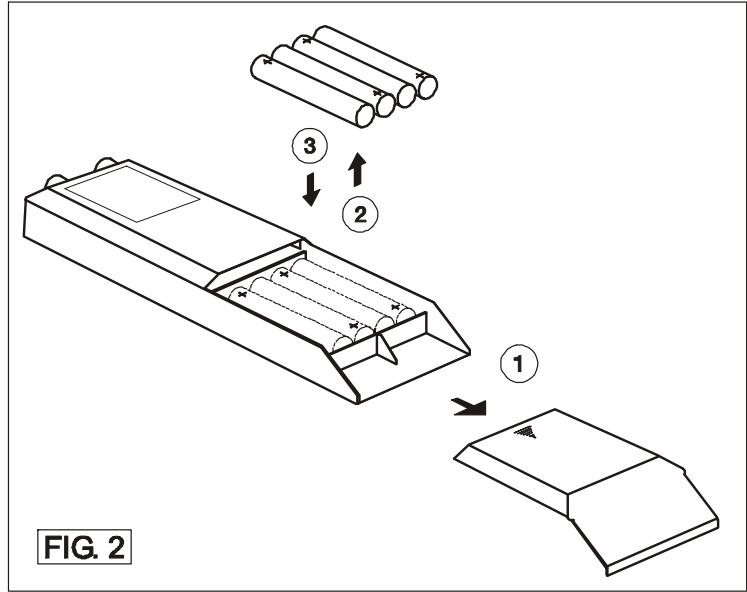
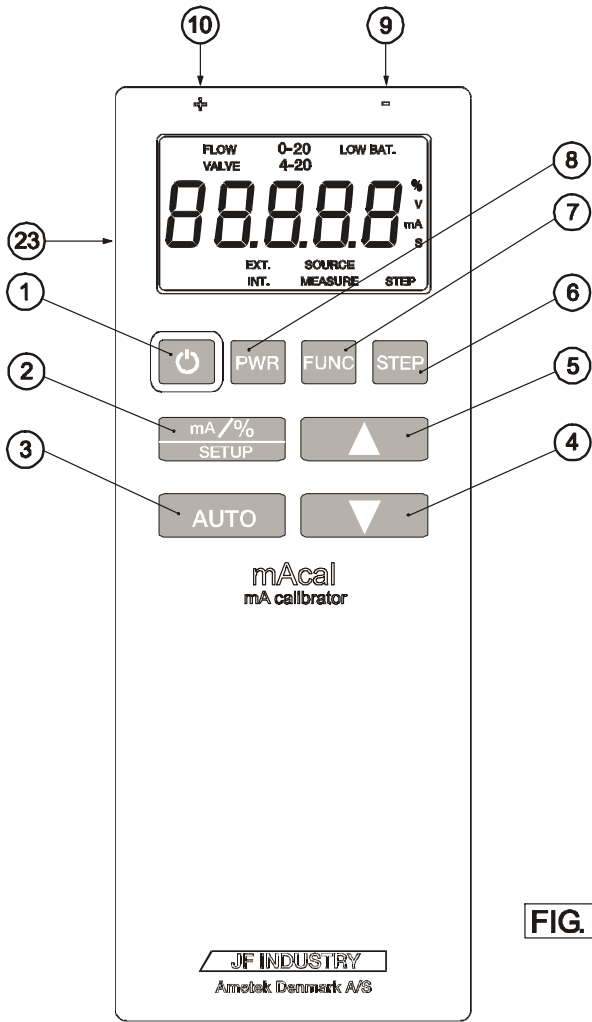

FIG. 2

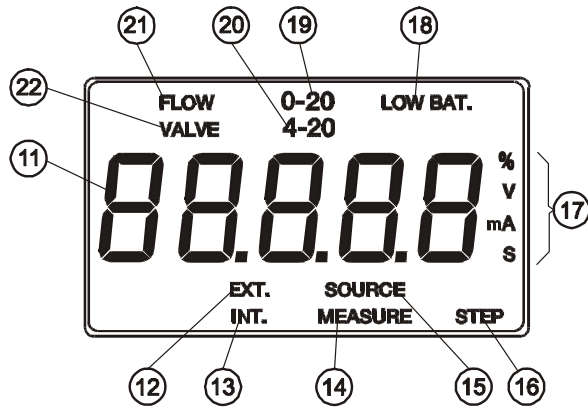
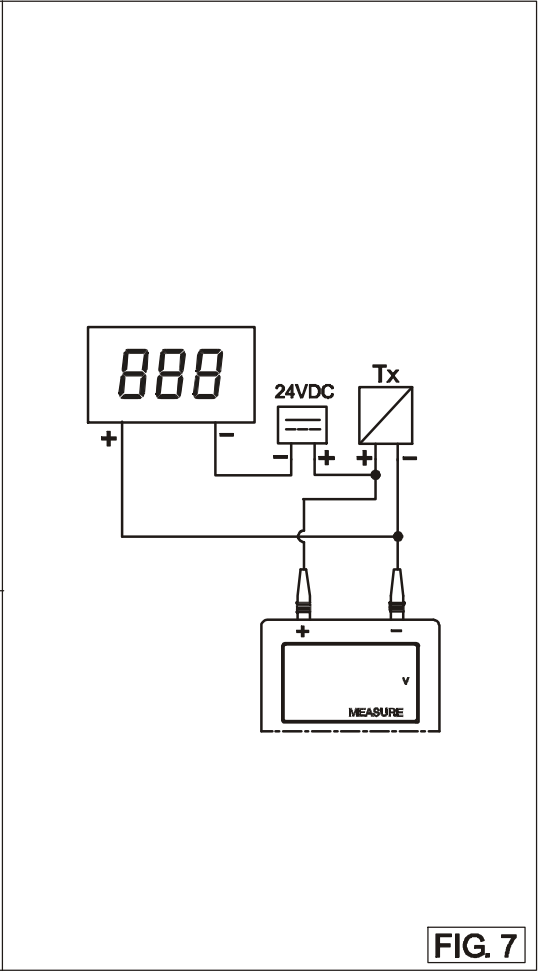
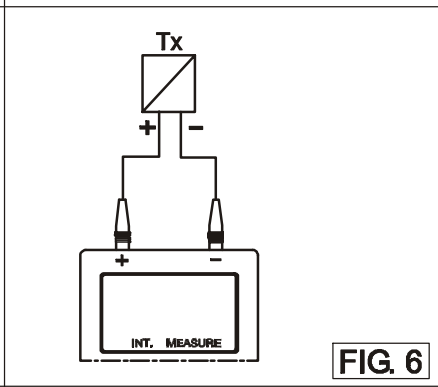
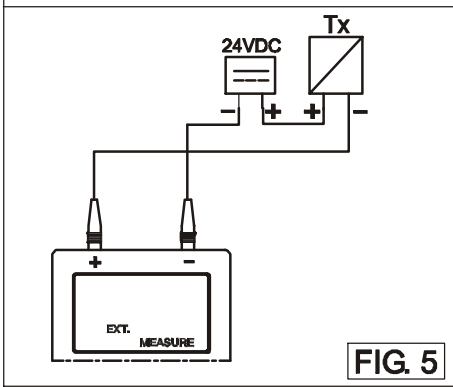
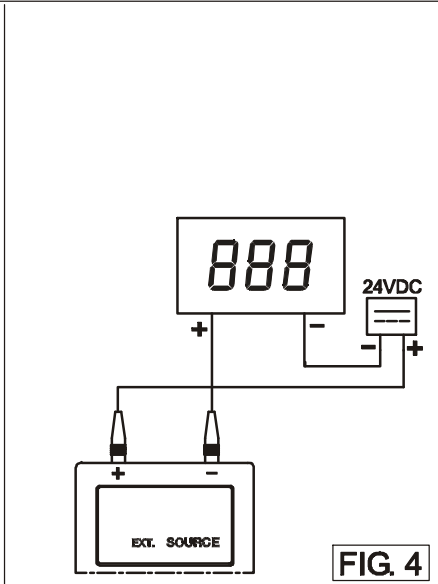
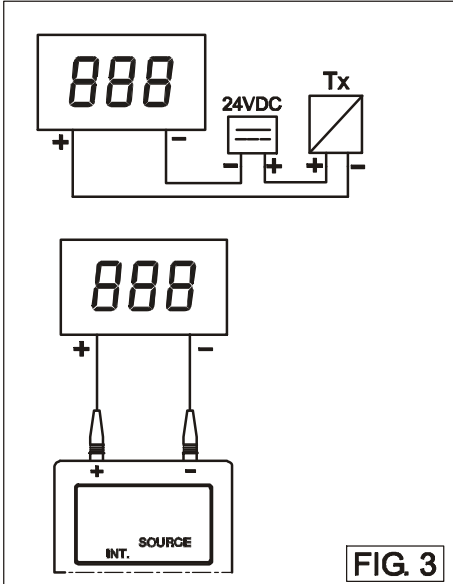

FIG. 1



LIST OF CONTENTS

1.	INTRODUCTION	
1.1	PACKING LIST.....	2
2.	SAFETY INSTRUCTIONS.....	3
3.	OPERATION	5
3.1	DISPLAY AND KEYBOARD	5
3.2	SWITCHING THE mAcal ON/OFF	7
3.3	HOW THE CURRENT IS GENERATED.....	7
3.4	HOW THE CURRENT IS MEASURED.....	8
3.5	HOW THE VOLTAGE IS MEASURED.....	9
3.6	HOW NEW PARAMETERS ARE SELECTED (SETUP).....	9
3.6.1	SELECTION OF MODE.....	9
3.6.2	SELECTION OF SLOPE TIME.....	10
3.6.3	SELECTION OF STEP SIZE	10
3.6.4	SELECTION OF STEP TIME	10
3.6.5	SELECTION OR DE-SELECTION OF AUTOMATIC OFF FUNCTION.....	10
4.	ERROR SITUATIONS.....	12
4.1	TEST FOR “OPEN LOOP”	12
4.2	TEST FOR INCORRECT POLARITY.....	12
4.3	TEST FOR “OVERRANGE”	12
4.4	INDICATION OF BATTERY STATUS.....	13
5.	HOW mAcal IS ADJUSTED (service mode)	14
6.	TECHNICAL SPECIFICATIONS (23°C±3°C).....	16

1. INTRODUCTION

The mAcal is a loop calibrator for measuring and generating mA. The mAcal is specially designed for use in industrial plants with 4-20mA signals. The mAcal can be operated with one hand, and operation is simple and intuitive.

ISO-9001 certified

AMETEK Denmark A/S was ISO-9001 certified in September 1994 by Bureau Veritas Certification Denmark.

CE-label



Your new loop calibrator bears the CE label and conforms to the Electromagnetic Compatibility (EMC) Directive 2014/30/EU and the Low Voltage Directive 2014/35/EU and RoHS Directive 2011/65/EU amended by Directive 2015/863/EU*.

Technical assistance

Please contact the dealer from whom you acquired the instrument if you require technical assistance.

1.1 PACKING LIST

When the instrument is received, the box should contain the following:

- mAcal
- Bag
- 2 test leads with crocodile clip
- 4 batteries, type LR6, AA
- 1 USB key containing documentation

mAcal from serial no. xxxxxx-09033

2. SAFETY INSTRUCTIONS



Read this manual carefully before using the instrument!

In order to avoid any personal injuries and/or damage to the instrument all safety instructions and warnings must be observed.

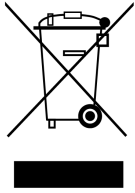

Disposal – WEEE Directive

These calibrators contain Electrical and Electronic circuits and must be recycled or disposed of properly (in accordance with the WEEE Directive 2012/19/EU).



WARNING:

- The calibrator **must not** be used for any purposes other than those described in this manual.
- Follow all equipment safety procedures.
- The calibrator has been designed for **interior use only** and should **not be used in hazardous areas**, where vapour or gas leaks, etc. may constitute a danger of explosion.
- **Do not** apply more than the rated voltage. See specifications for supported ranges.
- **Do not** use the calibrator if it is damaged. Before you use the calibrator, inspect the case. Look for cracks or missing plastic. Pay particular attention to the insulation surrounding the connectors.
- Select the proper function and range for your measurement.
- Make sure the battery cover is closed and latched before you operate the calibrator.
- Remove test leads from the calibrator before you open the battery door.
- Inspect the test leads for damaged insulation or exposed metal. Check test leads continuity. Replace damaged test leads before you use the calibrator.
- When using the probes, keep your fingers away from the probe contacts. Keep your fingers behind the finger guards on the probes.
- **Do not** use the calibrator if it operates abnormally. Protection may be impaired. When in doubt, have the calibrator serviced.
- Disconnect test leads before changing to another measure or source function.

- To avoid false readings, which could lead to possible electric shock or personal injury, replace the battery as soon as the battery indicator appears.
- To avoid personal injury or damage to the calibrator, use only the specified replacement parts and do not allow water into the case.



Caution...

- Disconnect the power and discharge all high-voltage capacitors before testing resistance or continuity.
- Use the proper jacks, function and range for your measurement or sourcing application.
- To avoid damaging the plastic lens and case, **do not** use solvents or abrasive cleansers.

3. OPERATION

3.1 DISPLAY AND KEYBOARD

The various keys on the keyboard have the following functions (cf. Fig. 1 on the cover of the user's guide):

ITEM	KEYBOARD	Description:
①	ON/OFF	Switching instrument on/off.
②	% mA / SETUP	Alternating between readout in mA and %. If the key is held down for more than 2 sec., a change to SETUP takes place. Under SETUP this key is used to select next parameter.
③	AUTO	AUTO ramp or AUTO-STEP function is started or stopped.
④	DOWN ARROW	"Less" key. If the key is held down, the key press is repeated.
⑤	UP ARROW	"More" key. If the key is held down, the key press is repeated.
⑥	STEP	The STEP function is activated or de-activated.
⑦	FUNC. (FUNCTION)	Change-over takes place between SOURCE mA, MEASURE mA and MEASURE Volt function.
⑧	PWR. (POWER)	Change-over takes place between EXT. (the +24VDC of the current loop is generated by an external power supply) and INT. (the +24VDC of the current loop is generated by the mAcal itself).

The various segments of the display indicate the following (cf. Fig. 1 on the cover of the user's guide):

ITEM	DISPLAY SEGMENT	Description:
⑪	888.88	Shows numerical value in mA, %, V or sec., and for readout of error codes etc.
⑫	EXT (EXTERNAL)	External loop supply is selected.
⑬	INT (INTERNAL)	Internal loop supply is selected, the internal +24VDC of the mAcal being used to supply the current loop with power.
⑭	MEASURE	Measurement of current or voltage is selected (indicated by unit).
⑮	SOURCE	Generation of current is selected.
⑯	STEP	The STEP function is active. When the segment flashes, this indicates that the AUTO-STEP function is activated.
⑰	%, s, V or mA	Indication of unit for readout numerical values.

ITEM	DISPLAY SEGMENT	Description:
18	LOW BAT (LOW BATTERY)	When this segment is lit, the voltage in the batteries is less than 3.5 V, and they should be replaced. When the segment flashes, the voltage is less than 3.1 V and the instrument cannot be operated.
19	0-20	0-20mA is selected as the range, which affects the readout in %, as well as STEP values.
20	4-20	4-20mA is selected as the range, which affects the readout in %, as well as STEP values
21	FLOW	FLOW transmitters are selected, which affects the readout in %, as well as STEP values.
22	VALVE	Proportional transmitters are selected, which affects STEP values and the AUTO-STEP function.

ITEM	CONNECTIONS	Description:
9	-	Connection of black test lead -
10	+	Connection of red test lead +
23		Connectio230mA.n to mains adaptor  + 6V DC, 230mA. Note : The mains adapter does not charge rechargeable batteries.

3.2 SWITCHING THE mAcal ON/OFF

1. Press  and the unit is switched on/off.

When the unit is switched on, the present battery voltage appears in the display for approx. 1 second.



Fit the red test lead into the connector marked “+”.

Fit the black lead into the connector marked “-”.

The mAcal is now ready for use. The unit automatically starts up in the function (SOURCE mA, MEASURE mA or MEASURE Volt) which was active when it was last switched off.

3.3 HOW THE CURRENT IS GENERATED

Connect the mAcal to the instrument to be tested as shown in Fig. 3 or Fig. 4 on the cover of the user’s guide and switch the unit on.



1. Press  until the display shows **SOURCE mA** or **SOURCE%**.
2. Press  for selection of INT or EXT (the present selection is shown in the display).

If INT. is selected, the +24VDC of the current loop is generated by the mAcal itself. If EXT is selected, the +24VDC of the current loop is generated by an external power supply.

3. Press  for selection of readout in mA or %.

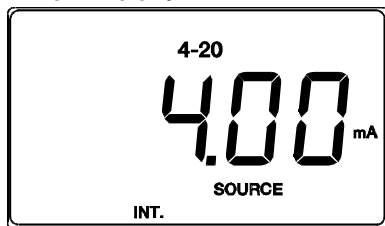
The display has the following appearance when 4mA is generated with internal loop supply:



4. Press  and the generated current is increased.
5. Press  and the generated current is decreased.

6. Press **STEP** for activation of pre-defined current values (values depend on selection of MODE and STEP SIZE).
7. Press **AUTO** for automatic changing of current value. If STEP is selected (the AUTO-STEP function), change-over takes place automatically between the pre-defined current values. For proportional transmitters (VALVE), change-over takes place between 3.8 - 4 - 4.2 - 4..... and 19 - 20 - 21 - 20..... mA (the range is selected using the “up arrow” or “down arrow” keys).

The mAcal now generates the current shown in the display.

3.4 HOW THE CURRENT IS MEASURED

Connect the mAcal to the transmitter to be tested as shown in Fig. 5 or Fig. 6 on the cover of the user’s guide and switch the unit on.

1. Press **FUNC** until the display shows **MEASURE mA** or **MEASURE %**
2. Press **PWR** for selection of INT or EXT (the present selection is shown in the display).

If INT is selected, the +24VDC of the current loop is generated by the mAcal itself. If EXT is selected, the +24VDC of the current loop is generated by an external power supply.

3. Press **mA/%
SETUP** for selection of readout in mA or %.

The display thus has the following appearance in the measurement of 20mA in the current loop.

The current is printed out with a resolution of 0.001mA:

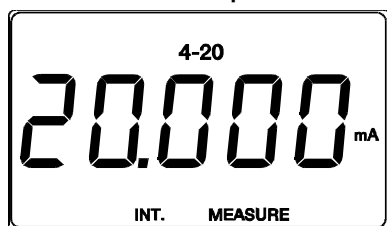

The mAcal now measures the current shown in the display.

3.5 HOW THE VOLTAGE IS MEASURED

Connect the mAcal to the instrument to be tested as shown in Fig. 7 on the cover of the user's guide and switch on the unit.

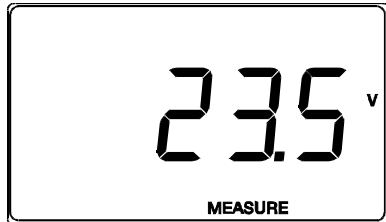

1. Press  until the display shows **MEASURE V**. Readout in % cannot be selected.

The display thus has the following appearance in the measurement in V. The voltage is printed out with a resolution of 0.1Volt:



The mAcal now measures the voltage shown in the display.

3.6 HOW NEW PARAMETERS ARE SELECTED (SETUP)

1. Press  for approx. 2 seconds. The present selection of MODE is now shown in the display, e.g. **4-20 mA**.
2. Press  to cancel a selection. SETUP is exited and it is necessary to start all over again. This option can be selected at any time.

3.6.1 Selection of MODE

It is possible to choose between 5 different MODES:

- 4-20mA LIN
- 0-20mA LIN
- 4-20mA FLOW
- 0-20mA FLOW
- 4-20mA VALVE

LIN - % calculated linearly.

FLOW - % calculated logarithmically.

VALVE - % not calculated.

AUTO-STEP function 3.8 - 4 - 4.2 - 4..... or 19 - 20 - 21 - 20..... mA.



1. Press  or  for selection of new MODE.

2. Press  to save the present selection.

3.6.2 Selection of SLOPE TIME

After MODE has been selected, SLOPE TIME (ramp time in the case of AUTO) can be changed.



The text **SLOPE s** is shown on the display for approx. 1 second.

1. Press  or  for setting of SLOPE TIME. The time can be adjusted between 30 - 999 S.

2. Press  to save the present selection.

3.6.3 Selection of STEP SIZE

After SLOPE TIME has been selected, STEP SIZE (step size in % of range) can be selected for the transmitter types LIN and FLOW. If MODE 4-20mA VALVE is selected, a fixed STEP SIZE is applied. The text **STEP** is shown in the display for approx. 1 second.

1. Press  or  for setting of STEP SIZE. A choice can be made between the step sizes 5%, 10%, 20%, 25%, 50% and 100%.

2. Press  to save the present selection.

3.6.4 Selection of STEP TIME

After STEP SIZE has been selected, STEP TIME (the time between changes in the AUTO-STEP function) can be changed. Either **30 s** or **10 s** is shown in the display.



1. Press  or  for setting of STEP TIME.

2. Press  to save the present selection.

3.6.5 Selection or de-selection of automatic OFF function

After STEP TIME has been selected, it is possible to select or de-select the AUTOMATIC OFF function (mAcal automatically switched off approx. 30 minutes after a key has last been activated).

The text **A-OFF** is shown in the display for approx. 1 second. Alongside, the text **ON** or **OFF** appears.

1. Press  and AUTOMATIC OFF is selected. **ON** appears in the display.
2. Press  and AUTOMATIC OFF is deselected. **OFF** appears in the display.
3. Press  to save the present selection.

SETUP is exited and the mAcal is now ready for normal operation with new parameters.

4. ERROR SITUATIONS

4.1 TEST FOR “OPEN LOOP”

The text **LOOP** flashes in the display:

CAUSE	The unit is unable to generate the desired current. The current loop is probably open or selection of PWR is incorrect.
REMEDY	<ul style="list-style-type: none">• Check whether instrument is connected correctly.• Check that PWR selection is correct.

4.2 TEST FOR INCORRECT POLARITY

The text **POL** flashes in the display:

CAUSE	The unit measures a negative current.
REMEDY	The test leads + and - are probably to be changed over.

4.3 TEST FOR “OVERRANGE”

The text **EEEE** flashes in the display:

CAUSE	The unit measures a current which is greater than 24mA or a voltage which is greater than +45Volts or less than -45Volts.
REMEDY	<ul style="list-style-type: none">• Measure only voltages in the range -45 to +45 Volts.• Measure only in current loops, where the current is less than 24mA.• Check that the instrument is connected properly. See Fig. 3 to Fig. 7 on the cover of the user's guide.

4.4 INDICATION OF BATTERY STATUS

- The text “**LOW BAT**” lights up in the display:
- The text “**LOW BAT**” flashes in the display:

CAUSE	<p><u>“LOW BAT” lights up:</u></p> <p>The batteries are about to be used up. However, the instrument can still be used.</p> <p><u>“LOW BAT” flashes:</u></p> <p>The batteries are used up. The instrument cannot be used. The display goes out. However, the keyed-in values are retained.</p>
REMEDY	<p><u>“LOW BAT” lights up:</u></p> <p>Change the batteries. See Fig. 2 on the cover of the user’s guide.</p> <p><u>“LOW BAT” flashes:</u></p> <p>The batteries must be changed. See Fig. 2 on the cover of the user’s guide. The 4 used LR6, AA batteries are removed and new ones inserted.</p>

5. HOW mAcal IS ADJUSTED (service mode)

Connect the mAcal to an external precision instrument (with an accuracy higher than 0.02% of F.S.) as shown in Fig. 3 on the cover of the user's guide.

1. Hold  down and press 

3 images appear in the display:

- The first display image shows the software version.
- After approx. 1 second, the serial number of the pcb is shown.
- After another approx. 1 second, the text **CODE** is shown (code must be keyed in).



2. Press  to exit service mode. This option can be selected at any time.

Key in the following code:

3. Press  3 times.
4. Press  5 times.
5. Press  Twice.
6. Press  Once.

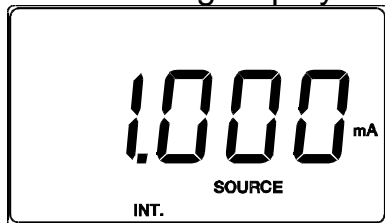

The following display image appears:

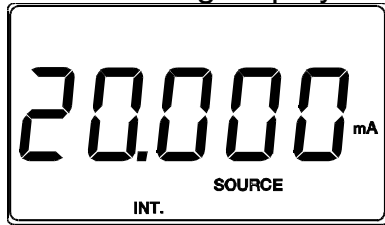

7. Press  or  until the display shows the same value as that measured with the external precision instrument.
8. Press  to approve the value.

The following display image appears:



9. Press  or  until the display shows the same value as is measured with the external precision instrument.
10. Press  to approve the value.

The mAcal now carries out a self-calibration and adapts its circuits to that measured. Switch on the mAcal. It is now adjusted and ready for use.

6. TECHNICAL SPECIFICATIONS (23°C±3°C)

Current generation	:	
Range	:	0-24mA
Resolution	:	0.01mA
Accuracy (k=2)	:	0.05% F.S.
Max. load	:	900 Ohm
Current measurement	:	
Range	:	0-24mA
Resolution	:	0.001mA
Accuracy (k=2)	:	0.05% F.S.
Input impedance	:	10 Ohm
Voltage measurement	:	
Range	:	0V to +45V
Resolution	:	0.1V
Accuracy	:	0.5V
Operation temperature	:	-10°C to +40°C
Storage temperature	:	-20°C to +50°C
Electromagnetic environment	:	Designed for use in basic electromagnetic environment as defined in EN61326-1 : 2013.
Battery life	:	200 hours with external loop pwr. 20 hours with 12mA output/internal loop pwr.
Battery types	:	4 types LR6, AA, 1.5V – Alkaline
Mains adapter	:	103950, 6V DC/230mA EURO with 1.3 mm DC female connector 103957, 6V DC/230mA UK, with 1.3mm DC female connector 103964, 6V DC/240mA US/JAPAN with 1.3 mm DC female connector
Dimensions l x w x h	:	174 x 66 x 26mm
Weight (incl. batteries, bag and test leads)	:	355 gr.

**Standard complied with
Warrenty**

:

(2014/30/EU), EN61326-1 : 2013
Electrical equipment for measurement,
control and laboratory use – EMC
requirements

According to current terms of sale and
Delivery. The guarantee only applies to
factory faults and ceases to apply if the
instrument has been subjected to un-
authorised interference and/or incorrect
operation.

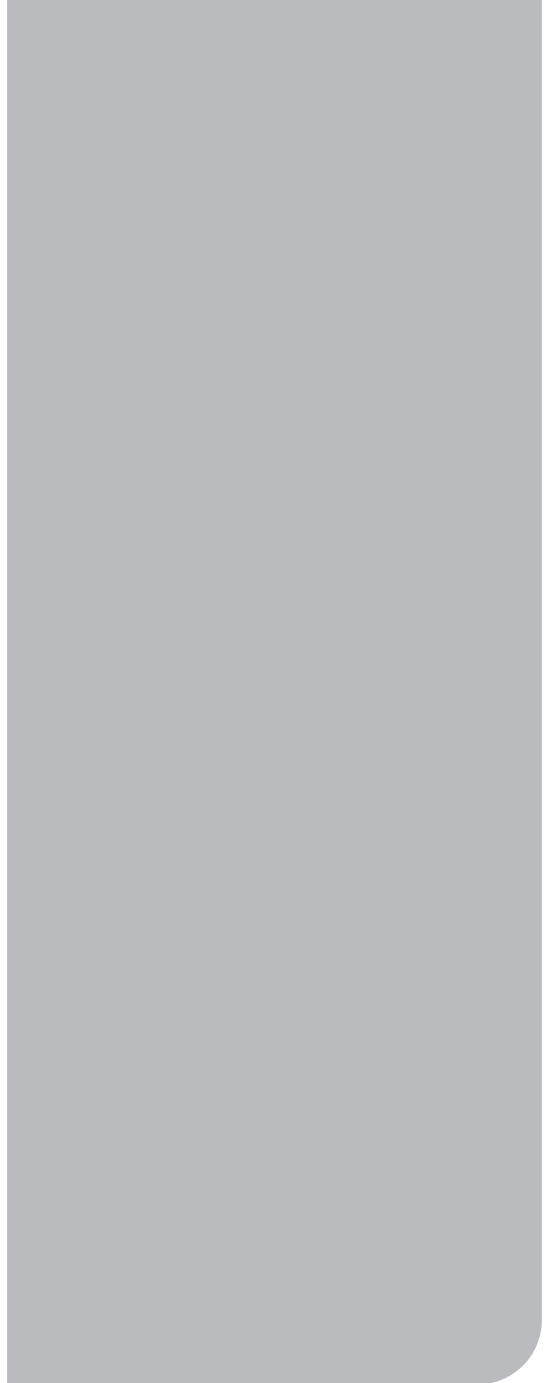

AMETEK[®]
SENSORS, TEST & CALIBRATION