

testo 445 · testo 645

Instruction manual

en



## Contents

Contents .....	2
Foreword.....	3
Initial operation .....	4
First measurement.....	5
Instrument description	
-Keypad/ connection assignment.....	6
-Display.....	7
Overview of controls.....	8-9
1. Current measurement.....	10
Switching on, selecting parameter in display .....	10
Saving, printing .....	10
2. Measurement functions 11-13	
Freezing readings.....	11
Maximum readings.....	11
Minimum readings.....	11
Multi-point mean calculation.....	12
Timed mean calculation .....	13
3. Location selection .....	14
4. Parameter settings .....	15-17
System adjustment ( <b>testo 645</b> ) .....	15
Adjusting humidity probes.....	16
Displaying calculated humidity parameters (td°C; g/m <sup>3</sup> ; g/kg; J/g).....	16
Switches CO <sub>2</sub> ppm → Vol% ( <b>testo 445</b> ) .....	16
Initialising differential pressure probe ( <b>testo 445</b> ).....	17
Activating m/s in differential pressure probes ( <b>testo 445</b> ) .....	17
Activates volume flow and sets duct cross-sections for velocity and differential pressure probes ( <b>testo 445</b> ) .....	17
5. Memory settings.....	18-21
Overview .....	18
Manual saving .....	19
Automatic saving.....	19
Reading or printing memory contents .....	20
Clearing memory contents .....	21



According to the conformity certificate, the instruments fulfill **2014/30/EC** guidelines.

© 1999 Copyright Testo GmbH & Co.  
The software and software structure included in the product **testo 445/645** are protected by copyright laws worldwide.

## Contents

---

6. Instrument configuration.....	22-26
"AutoOFF" power save function .....	22
Setting power supply, with rechargeable battery or battery.....	23
Setting date/time.....	24
Setting parameters for absolute pressure and density compensation.....	25
Unit selection .....	26
Factory reset.....	26
7. Velocity measurement .....	27-28
Volume flow funnel ( <b>testo 445</b> ).....	27
Pitot tube and pressure probe (testo 445).....	28
Thermal anemometer probes (testo 445) .....	28
8. CO/CO <sub>2</sub> measurement.....	29-30
Measuring absolute pressure.....	31-32
Error messages .....	33
Technical data.....	34-35
Ordering data .....	36-41

## Foreword

Dear Customer

You have made the right decision by choosing a measuring instrument from Testo. Every year, thousands of customers purchase our high-quality products. There are many good reasons for this.

- 1) We offer value for money. Reliable quality at the right price.
- 2) Considerably longer guarantee periods of up to 3 years - depending on the instrument.
- 3) With over 40 years of specialist experience we are optimally equipped to solve your measuring tasks.
- 4) Our high quality standards are confirmed by ISO 9001 certification.
- 5) It goes without saying that our instruments bear the CE mark required by the EU.

### Please read prior to measurement



Do not measure on live parts.

Do not switch instrument on or off with the  button  
- during instrument configuration  
- during automatic saving

Complete automatic saving before connecting instrument to the Comfort software.

If the instrument does not function remove battery and put it in again. The respective error message is shown in the display. Refer to the information on "Error messages" on page 33 of the Instruction manual.

Observe storage and transport temperature and max. operating temperature (e.g. protect measuring instrument from direct sunlight)

When changing configurations (e.g. changing the probe), the instrument should be switched off because the values specific to the probe can only be read when the instrument is switched on. The V24 cable (PC connection) can be inserted anytime.

A simultaneous print command is not possible if the PC cable is connected.

Ensure that the contacts are correct in probes with a plug-in head.  
The swivel nut in the probe handle should be securely tightened.

Opening the instrument, inexperienced handling and use of force cancels your warranty.

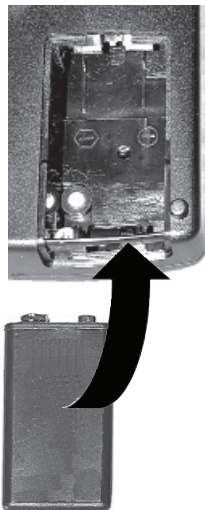

### Putting in the batteries

9V block battery is included in delivery.

Open the battery compartment at the back of the instrument.  
Put in block battery. **Observe polarisation.**  
Close battery compartment.

Refer to "Power supply" Chapter for more information on alternative power supply, charge, battery quality, charging procedure.



Observe instrument configuration when using rechargeable batteries.

## First measurement

---

**A description of the instrument and an overview of the controls guarantee a quick introduction.**

**Note:** The measuring instrument must be switched off before a probe is connected.



Instrument configuration

You will receive up-to-date readings once a probe is inserted and the measuring instrument is switched on. However, you will still need to update or define the data in the instrument:

- ⇒ Date/Time:
- ⇒ Auto Off:
- ⇒ Units:

Some things can only be set via PC software (See Ordering data):

- ⇒ Location name (8 characters)
- ⇒ Log head (24 characters), e.g. your company name - is also printed when readings are printed.

## Instrument description

### Keypad/Connection assignment

#### Connection assignment:

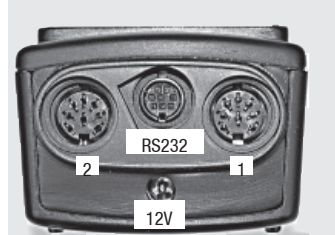

#### testo 445

##### Socket 1:

- Thermal velocity probes (heated wire or ball)
- Vanes (inductive)
- Temperature probes (Type K/J/S T/C or NTC)
- Differential pressure probes (piezoresistive)
- Absolute pressure probes (piezoresistive)
- CO<sub>2</sub> probe (2 beam infrared sensor)
- CO probe

##### Socket 2:

- Combined probe for humidity (capacitive) and temperature (NTC or Ni 10000)
- 3-function probe for humidity (capacitive), temperature (NTC) and velocity (ball)

**RS232:** PC connection

**12V:** Mains connection

#### testo 645

##### Socket 1:

- Temperature probes (T/C type K/J/S or NTC)

##### Socket 2:

- Combined probe for humidity (capacitive) and temperature (NTC or Ni 10000)
- Temperature probes (PT100)

**RS232:** Connection for PC

**12V:** Mains unit connection

#### Keypad:

On/Off

Prints

Confirms menu setting/  
executes function

Saves

Return to current measurement/  
location

Arrow buttons  
move the cursor

Hold Max Min  
Mean

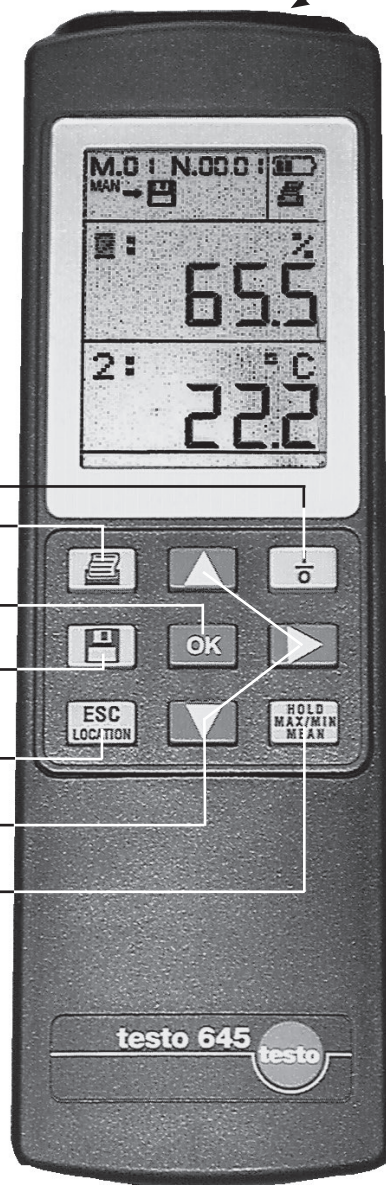

## Instrument description

### Display

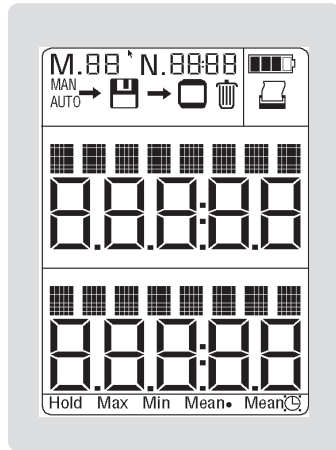

➡ The symbols on the top line are explained below

➡ Name of input socket and parameter

➡ Displays reading in line 1

➡ Name of input socket and parameter

➡ Displays reading in line 2

➡ Displays measurement functions

#### Explanation of symbols:

Counter for the log number in the memory.

When saving manually: number of a measurement saved.

When saving automatically: number of a measurement series.

This counter is needed in order to be able to find single logs or a measurement series when reading the memory.

M. 00

Counter for saving a measurement cycle (is only required with automatic saving).

The measurement cycle in a measurement series can be found.

N. 0000



Manual saving of a single measurement by pressing the save button .



Automatic saving program has been set up. Saving is activated by pressing the button.



Symbol for reading contents of memory on display.



Symbol for deleting memory contents



If this symbol appears, the printing function is activated.

The symbol flashes while data is being transmitted. You can print on the desktop printer by pressing the print button .



Shows capacity of battery and rechargeable battery.



If the inner segment no longer appears (symbol flashes), the battery has to be changed or the rechargeable battery has to be recharged. The instrument switches itself off automatically after 1 minute.

## Overview of controls

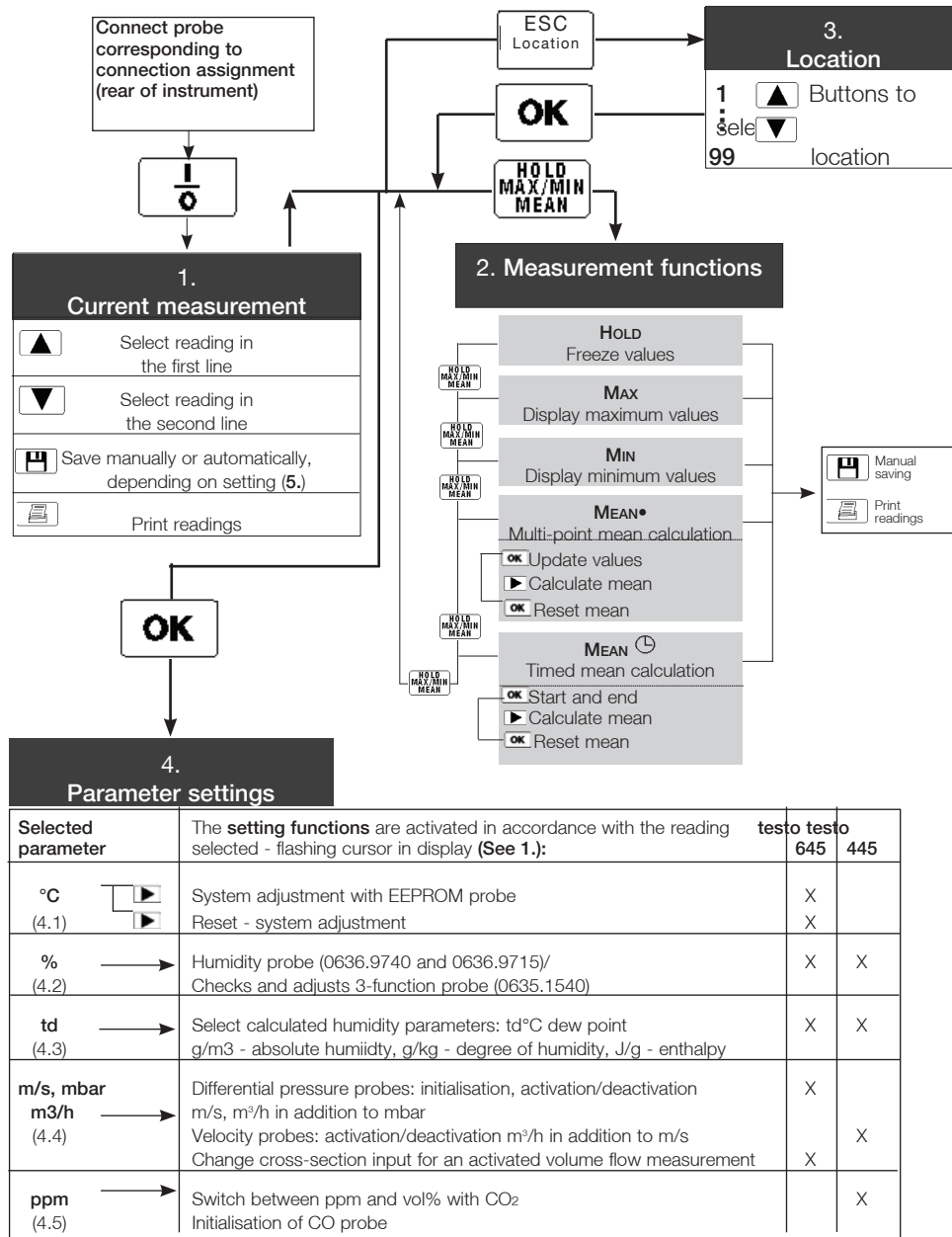

Selected parameter	The <b>setting functions</b> are activated in accordance with the reading selected - flashing cursor in display ( <b>See 1.</b> ):	testo 645	testo 445
°C (4.1)	System adjustment with EEPROM probe Reset - system adjustment	X	X
% (4.2)	Humidity probe (0636.9740 and 0636.9715)/ Checks and adjusts 3-function probe (0635.1540)	X	X
td (4.3)	Select calculated humidity parameters: td°C dew point g/m <sup>3</sup> - absolute humidity, g/kg - degree of humidity, J/g - enthalpy	X	X
m/s, mbar m <sup>3</sup> /h (4.4)	Differential pressure probes: initialisation, activation/deactivation m/s, m <sup>3</sup> /h in addition to mbar Velocity probes: activation/deactivation m <sup>3</sup> /h in addition to m/s Change cross-section input for an activated volume flow measurement	X	X
ppm (4.5)	Switch between ppm and vol% with CO <sub>2</sub> Initialisation of CO probe		X



## 1. Current measurement

### Switching on / Selecting parameters / Saving / Printing

Connect measurement probes

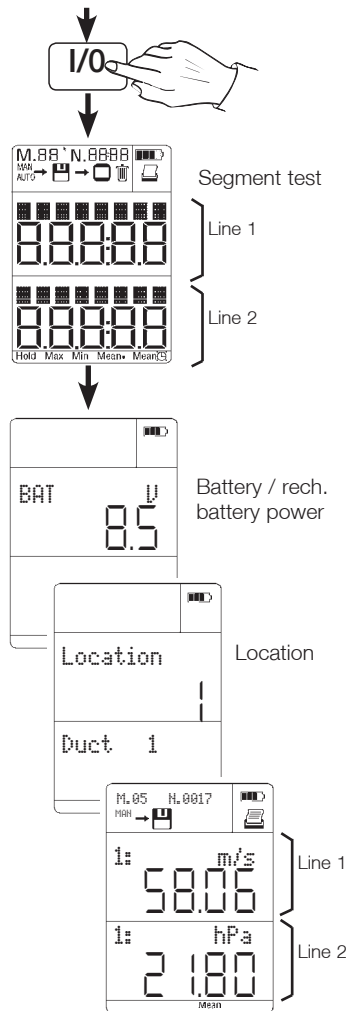

Current readings - different, depending on probe(s) connected.

All of the readings, made available by the probes connected to socket 1 and 2, on both lines of the reading display can be called up with the exception of the value selected in the other line.

Scroll with ▲ button in line 1:

① Select socket.

② Select parameter.

If this button in multi-function probes is pressed repeatedly, it is possible to select the parameter (°C, m/s...) to be displayed.

Scroll with ▼ button in line 2:

① Select socket.

② Select parameter.



If this button in multi-function probes is pressed repeatedly, it is possible to select the parameter (°C, m/s...) to be displayed.

There are different processing options available in the menus described below corresponding to the parameters selected.

Example of a reading:



It is possible to activate the following functions during measuring at the touch of a button.

-  **Save readings**  
Manual or automatic saving is determined by the save setting (Chapter 5)
-  **Print readings.**

**Note on printing:**

A distance of 0.5 m should not be exceeded in order to guarantee problem-free data transfer. Objects between instrument and printer prevent the data from being transferred. Please observe notes in the instruction manual on the printer.

## 2. Measurement functions

### Hold/Max/Min

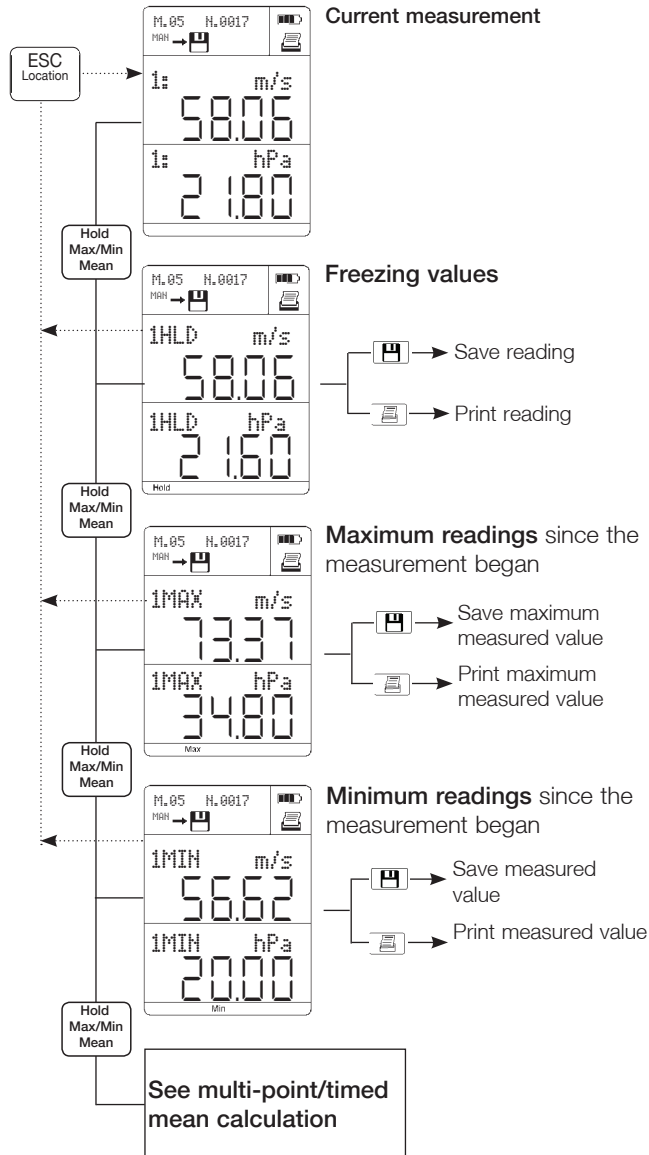

## 2. Measurement functions

Multi-point mean calculation **Mean•**  
Only for parameter in the 1st line

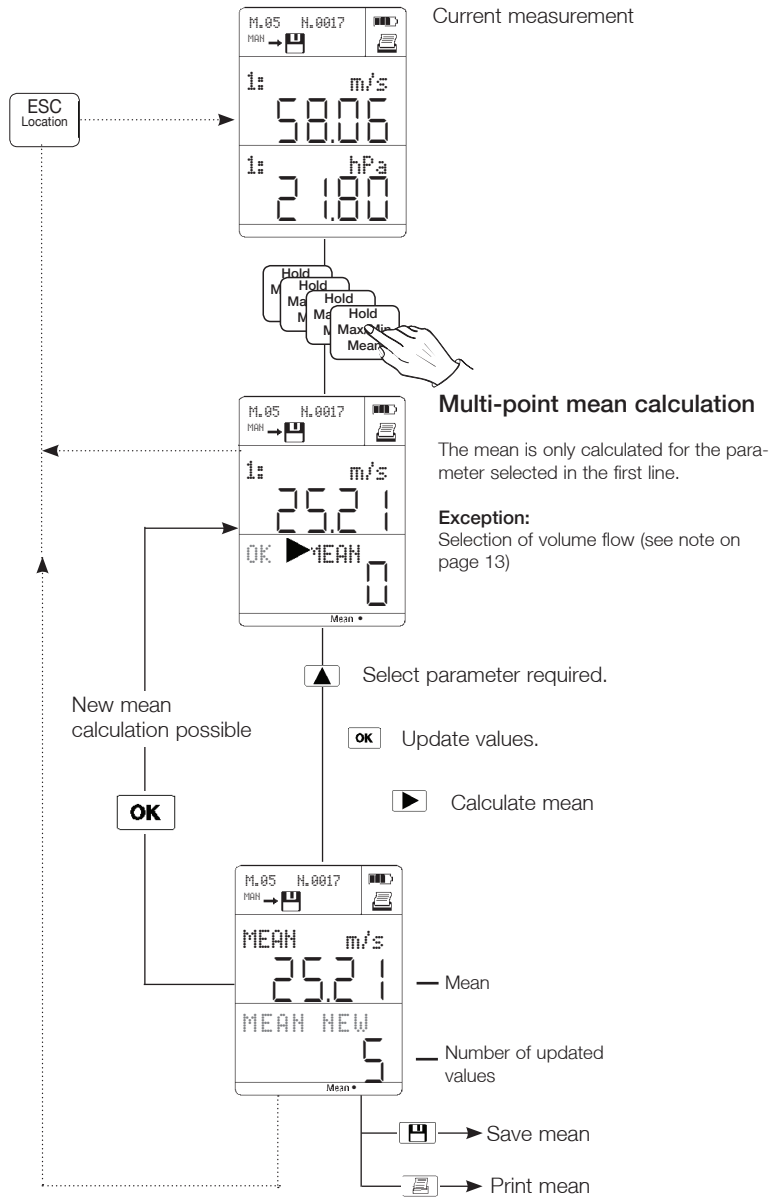

## 2. Measurement functions

Current measurement

Timed mean calculation **Mean** ⌚  
Only for parameter in the 1st line

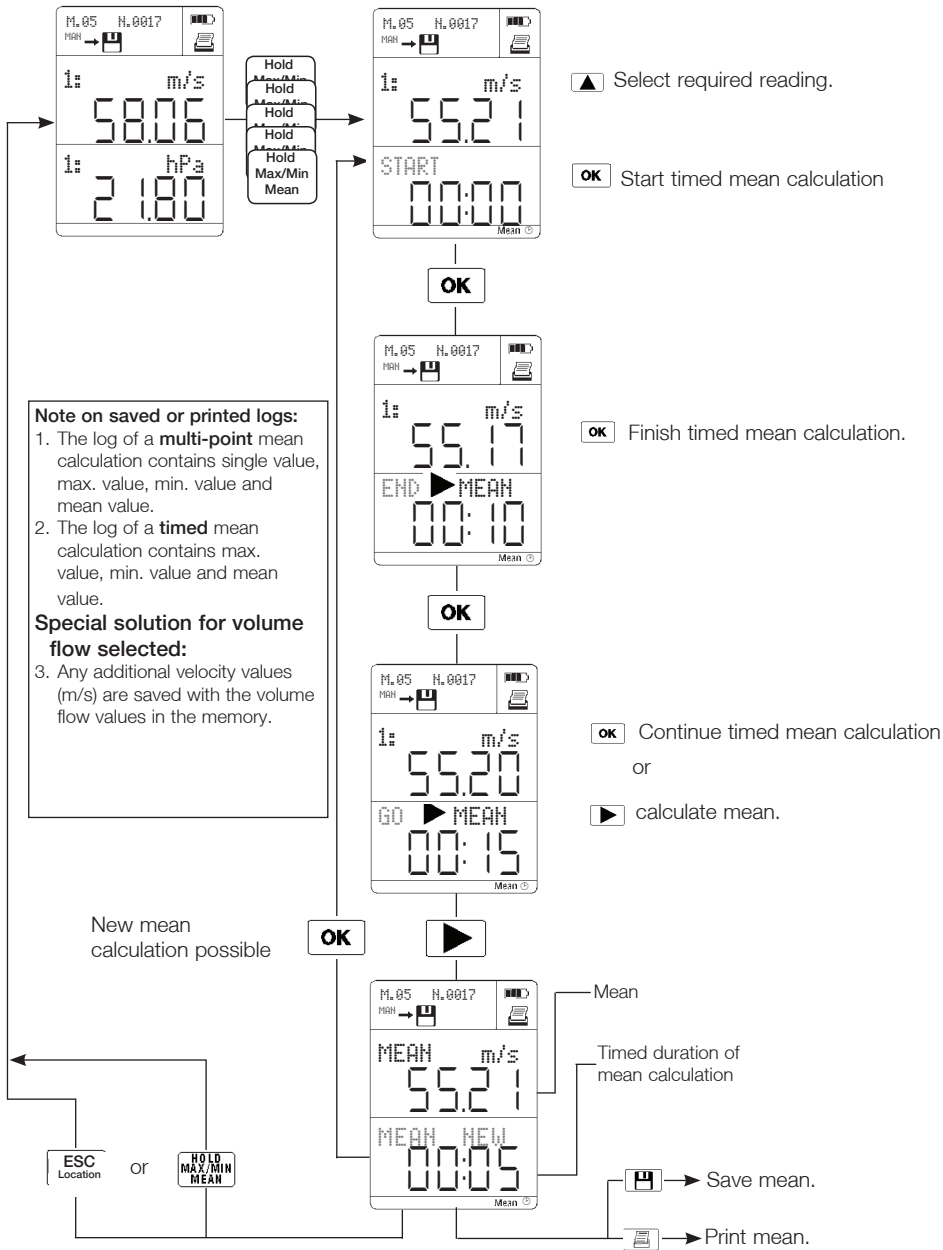

### 3. Location selection

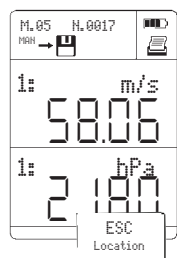

1. Current measurement

The location names Location 1 to 99 are specified by the factory.

Additional location names (8 characters) can only be loaded onto your instrument using PC software.

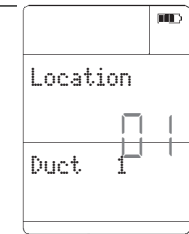

▲/▼ Select location

OK

The **cross-section** can only be called up if volume flow is activated (testo 445 instrument)

Return to current measurement

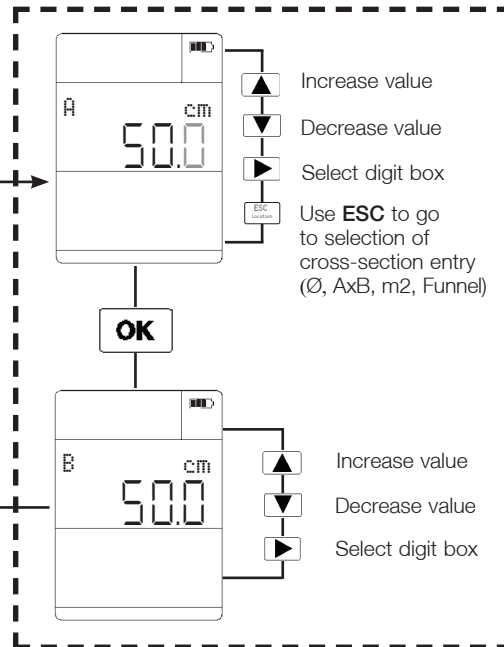

🖨 or 📄:  
From now on all measured data which is saved or printed is linked to the selected location or product names.

## 4. Parameter settings

### System adjustment



The **setting functions** are activated in accordance with the reading selected - flashing cursor in display.

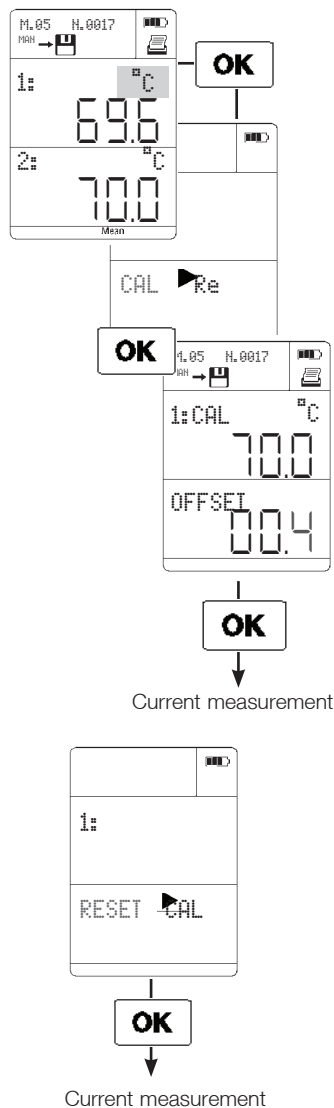

#### System adjustment (only possible in testo 645):

testo 645 and probes with EEPROM (Part no. 0614.xxxx) can be adjusted to the "zero error adjustment point". The probe characteristic saved in the measuring instrument is offset at a measurement point. This is simply entered in the instrument at the touch of a button. The following serves as a reference for offset calculations:

- A Testo calibration certificate or
- A highly accurate Pt100 probe:  
An accurate Pt100 probe measures the temperature at socket 2; an inaccurate but quick probe measures in the same substance; the offset correction must be such that both probes show the same value.

**Example:** The reference probe in socket 2 measures 70.0 °C in the vat.  
The probe in socket 1 measures 69.6 °C.  
Correct by 0.4 °C!

The respective flashing position can be changed using the buttons or confirmed by pressing .

#### Note:

Offset is saved in probes with EEPROM and is automatically recognised when the instrument is switched on. In probes without EEPROM, the set offset is located in the input socket. The OFFSET value is displayed or printed when switching on, saving or printing.

**Deleting system adjustment:** The set OFFSET is reset to 00.0.

## 4. Parameter settings

### Adjusting: humidity probes / humidity parameters / ppm → vol%

The **setting functions** are activated in accordance with reading selected - flashing cursor in display.

**Adjusting humidity probes**  
**Monitoring and adjusting** humidity probes (0636.9740/0636.9715) or 3-function probe (0635.1540).

To carry out the adjustment, immerse the probe in the adjustment container belonging to the control and adjustment set (Part no. 0554.0660). Observe the instructions given in the Instruction manual (0973.1820)!

NO flashes → **OK** → No adjustment.  
 YES flashes → **OK** → The probe is adjusted.

▶ → Switch to YES/NO  
**OK** → Confirm selection and return to measurement.

**Displaying calculated humidity parameters.**  
 If Testo's combination humidity probe (e.g. 0636.9740) is connected, testo 445 and testo 645 display a calculated humidity parameter in addition to temperature and relative humidity. You can select from the following parameters:

td°C	▶	g/m <sup>3</sup>	▶	g/kg	▶	J/g	▶	td°C ...
Dew point temperature		Absolute humidity		Degree of humidity		Enthalpy		

Degree of humidity and enthalpy are pressure-dependent parameters. Absolute pressure has to be set (See 6. Instrument configuration -Parameter setting).

The respective selected parameter flashes.

▶ → Select  
**OK** → Confirm selection and return to measurement..  
 The selected humidity parameter is displayed.

**Switch between ppm and vol% if a CO<sub>2</sub> probe is connected (only possible in a testo 445 instrument).**

ppm ▶ vol% ▶ ppm ...

The respective selected parameter flashes.

▶ → Select  
**OK** → Confirm selection and return to measurement.



## 5. Memory settings

### Overview

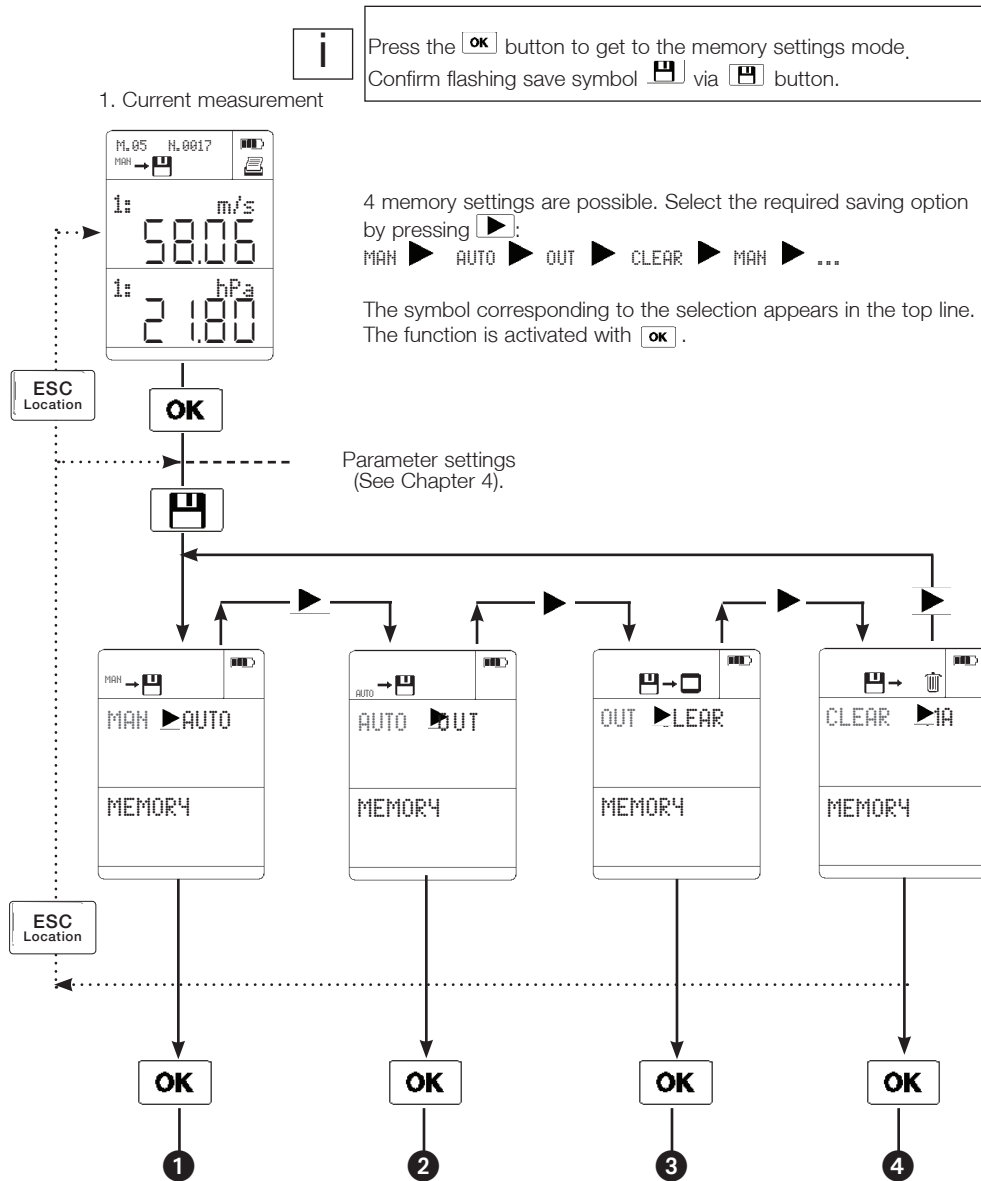

## 5. Memory settings

### Manual / Automatic saving

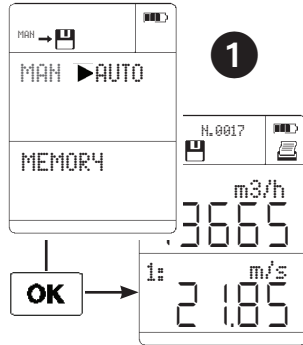

MAN

#### Manual saving:

Each time is pressed a log of the measurement is saved in the instrument and includes measured values, location, date and time. The counter in the top left corner of the display shows the number of logs saved for this location.

#### Saving a log with timed or multi-point mean calculation :

The log includes MIN value, MAX value and mean of the measurement and also single values in multi-point mean calculations.

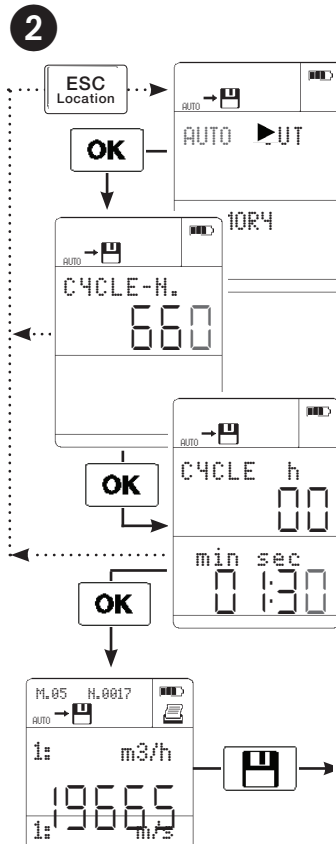

AUTO

#### Automatic saving:

When this saving function is set, the instrument automatically accepts the measured values at fixed intervals and saves them (=logger operation).

The number of measuring cycles (CYCLE-N.) to be saved and intervals (CYCLE) have to be programmed:

#### 1. Cycle-N.

The instrument automatically offers the maximum possible number of measuring cycles. Set required number using / / .

Confirm set value by pressing .

#### 2. Cycle

Select interval in which the measured values are to be saved. The blinking position can be changed using .

Confirm set value by pressing .

Automatic saving is started by pressing . The symbol flashes until the programmed measurement series is accepted.

Cancel saving procedure.  
 Starts automatic saving again.  
 An additional measurement series is added.

## 5. Memory settings

### Reading or printing memory contents

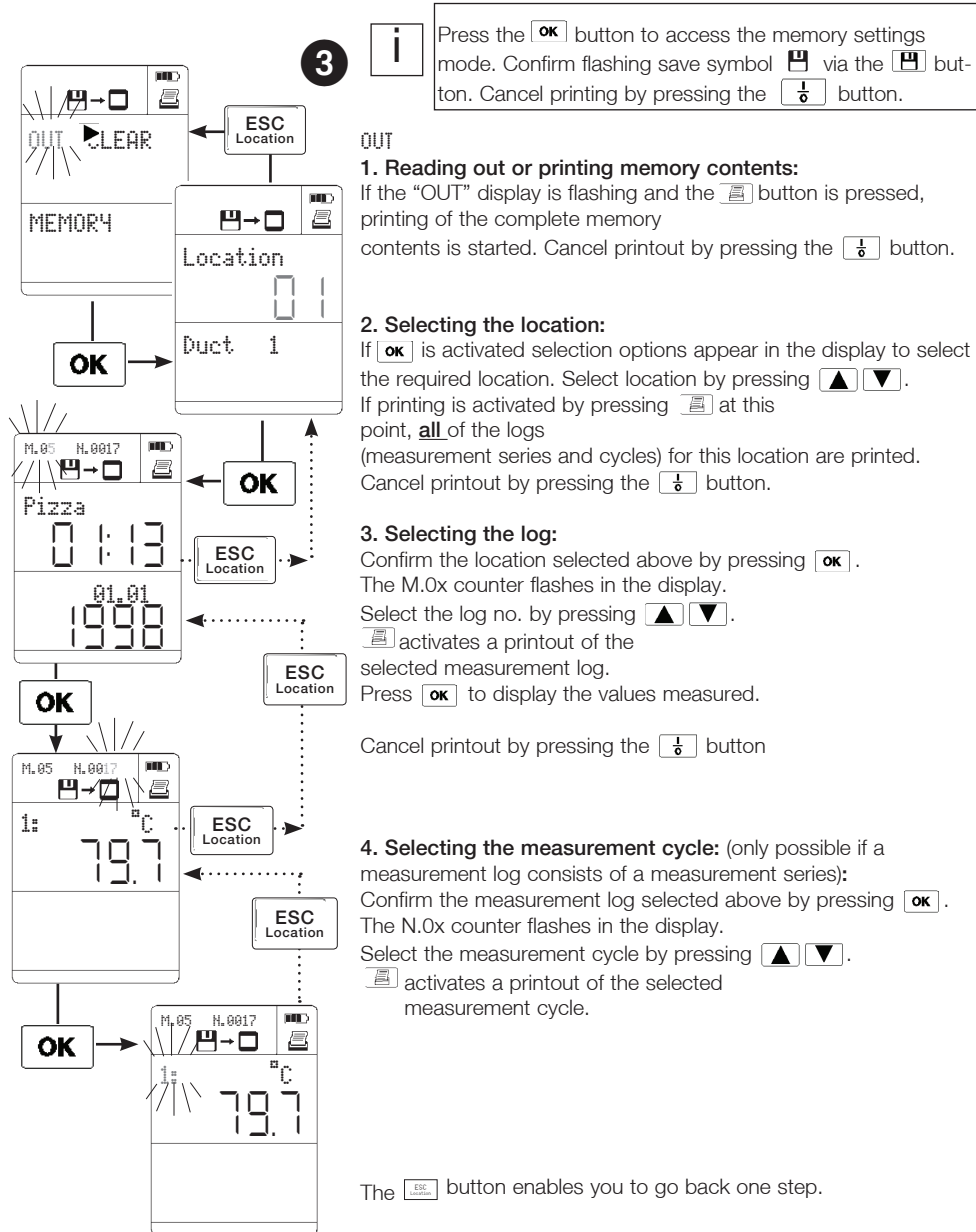

## 5. Memory settings

### Clearing memory contents/Sample printouts

 Press the **OK** button to access the memory settings mode. Confirm flashing save symbol  via the  button.

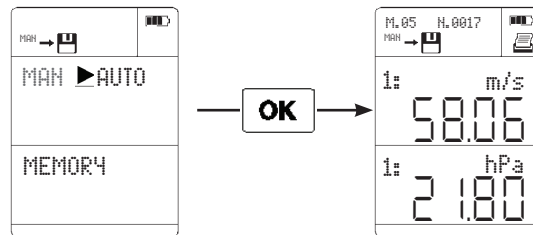
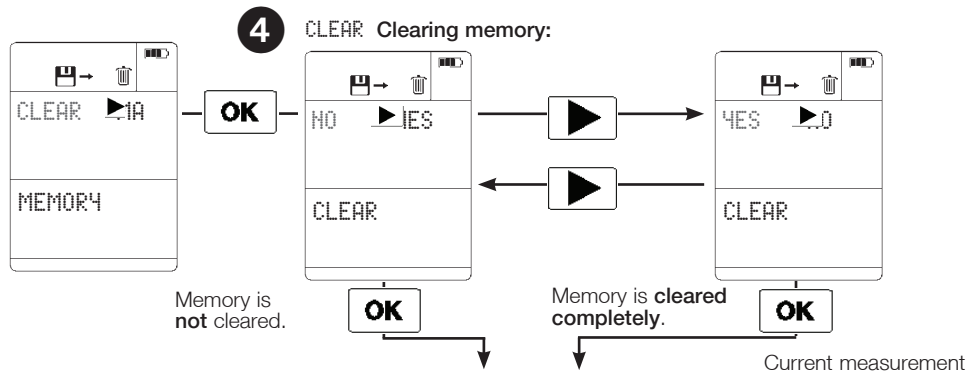

Printout of automatic saving procedure:

```

Header ----- Firma Mustermann
Date of printout ----- 31.08.1998 11:27:32
Location ----- Raum 1

Log ----- M.002
Start of saving ----- 31.08.1998 11:26:59

Save ----- cycle: 00:0002
-----
1: °C      2: %      2: °C
01      21.4      45.1      22.2
02      21.2      44.7      22.3
Readings ----- 03      21.1      44.6      22.3
04      21.8      44.6      22.3
-----
2: m/s     2: td °C
01      1.00      9.8
02      1.66      9.7
03      2.01      9.7
04      1.52      9.7

Info :
    
```

Printout of manual saving:

```

Messrs. Smith
31.08.1998
11:26:05
Raum 1

M.001
31.08.1998
11:20:05

1: 21.4      °C
2: 44.7      %
2: 22.1      °C
2: 0.55      m/s
2: 9.6       td °C

Info :
    
```

## 6. Instrument configuration

### Power save function / Power supply

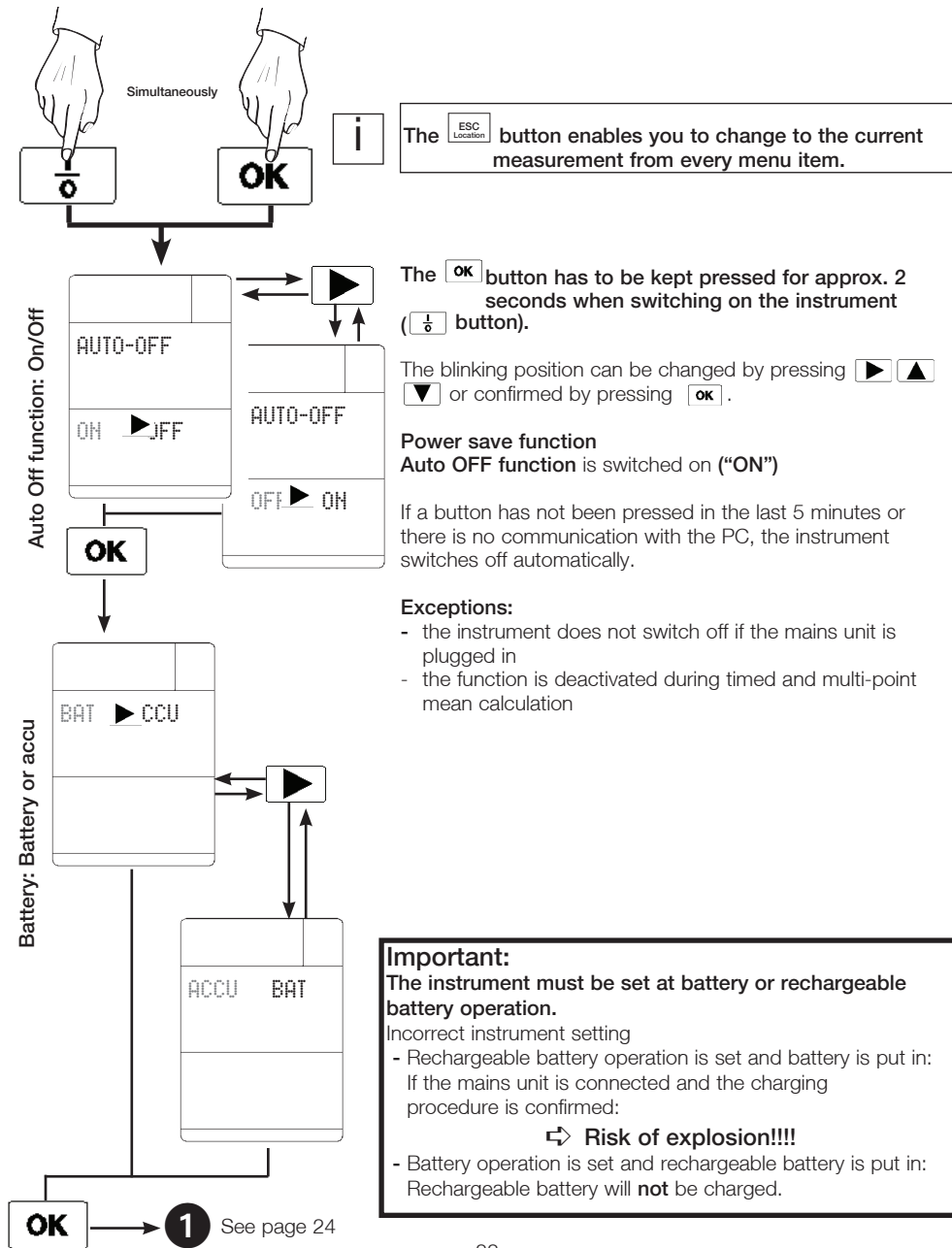

## 6. Instrument configuration

### Power supply

**Battery operation** with 9 V block battery, alkali manganese IEC 6LR61.

Parallel power supply is possible with mains unit without damaging batteries.

Zinc carbon batteries should not be used with thermal probes because their inner resistance is too high and the probe is not supplied with sufficient energy. The instrument switches off.

**Rechargeable battery operation** with Testo rechargeable battery (Part no. 0515.0025), Type: Ni-MH IEC 6F22.

If the **rechargeable battery is empty**: Parallel power supply and simultaneous recharging of the battery in the instrument with mains unit.

Connect mains unit to **recharge battery**. Query as to whether rechargeable battery should be recharged.

Has a rechargeable battery or battery been put in? **Check!**

There is a risk of explosion if batteries have been put in! Select "NO" in this case.

If a rechargeable battery is inside confirm Charge "Yes" with

The instrument can be switched off if a measurement is not taking place. The rechargeable battery capacity and power is displayed. Recharging takes approximately 6 hours if the rechargeable battery is completely empty.

**Correct battery recharging in the instrument via the mains unit can only be guaranteed if the above mentioned Testo rechargeable batteries are used. If other rechargeable battery types are used, recharging will have to be carried out by an external recharger.**

**Note:**

The instrument should be switched off before changing the battery/rechargeable battery or when operating using mains unit without rechargeable battery and battery. If the battery/rechargeable battery is removed, the instrument loses the set values (date/time). The capacity of the battery/rechargeable battery is shown in the display:



100 %



75 %



50 %



25 % (if the last segment is flashing the battery/rechargeable battery is almost empty)





0 % (change battery/recharge rechargeable battery). Instrument will switch off after 1 minute.

**Operation via mains unit (Part no. 0554.0088):**

Insert mains unit in the mains unit socket of the instrument (see connection assignment).

## 6. Instrument configuration

### Setting date/time

 The  button enables you to change to the current measurement from every menu item.

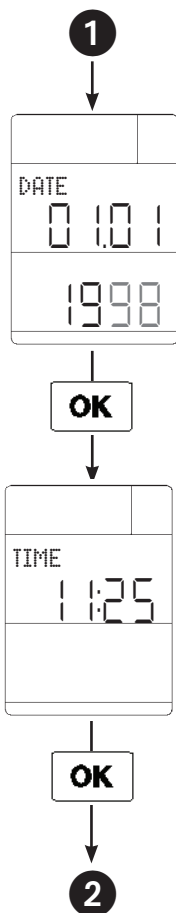

#### Setting date

The flashing position in the display can be set  
- /  = scroll/  = next position -

#### Setting the time

The blinking position in the display can be set  
- /  = scroll/  = next position -

## 6. Instrument configuration

### Parameters

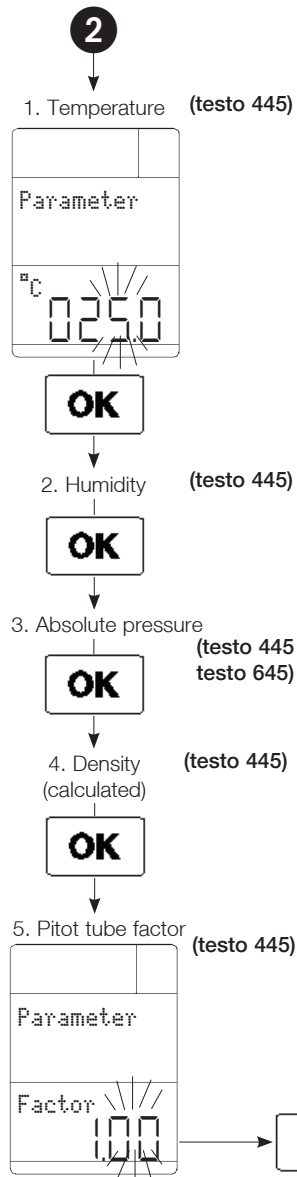

#### Parameter setting for pressure and density compensation:

Humidity (g/kg, J/g), velocity (measured with thermal probes) and CO<sub>2</sub> are pressure-dependent parameters.

Density is included in the measurement when velocity is measured using a Pitot tube.

**testo 445/645 automatically carries out pressure and density compensation. Temperature, humidity and absolute pressure must be entered.**

3 parameters can be measured on location using a Testo humidity/temperature probe (e.g. Part no. 0636.9740) and the Testo absolute pressure probe (Part no. 0638.1645). See the Chapter "Measuring absolute pressure" for more information on measuring absolute pressure without an absolute pressure probe.

**Density is automatically calculated by the instrument based on these 3 values:**

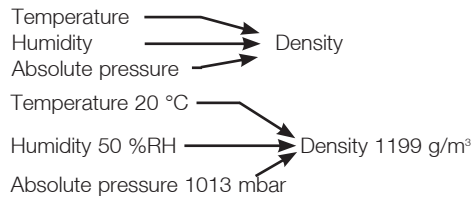

#### Note:

If the density set in the factory is taken as the basis, the measurement error can be up to 10% of the measurement when velocity is measured using a Pitot tube. Parameters must be determined and set in the instrument in order to achieve exact measurements.

The flashing position in the display can be set.

- ▲/▼ = Scroll/ ► = Next position -

OK = Confirm.

Print icon = Print parameter.

#### Pitot tube factor setting:

The factor for Pitot tubes from Testo is constantly at 1.00 and does not need to be changed. If the Pitot tubes from other firms are used, ask your supplier for the Pitot tube factor and save in instrument.

## 6. Instrument configuration

### Unit selection / Factory reset

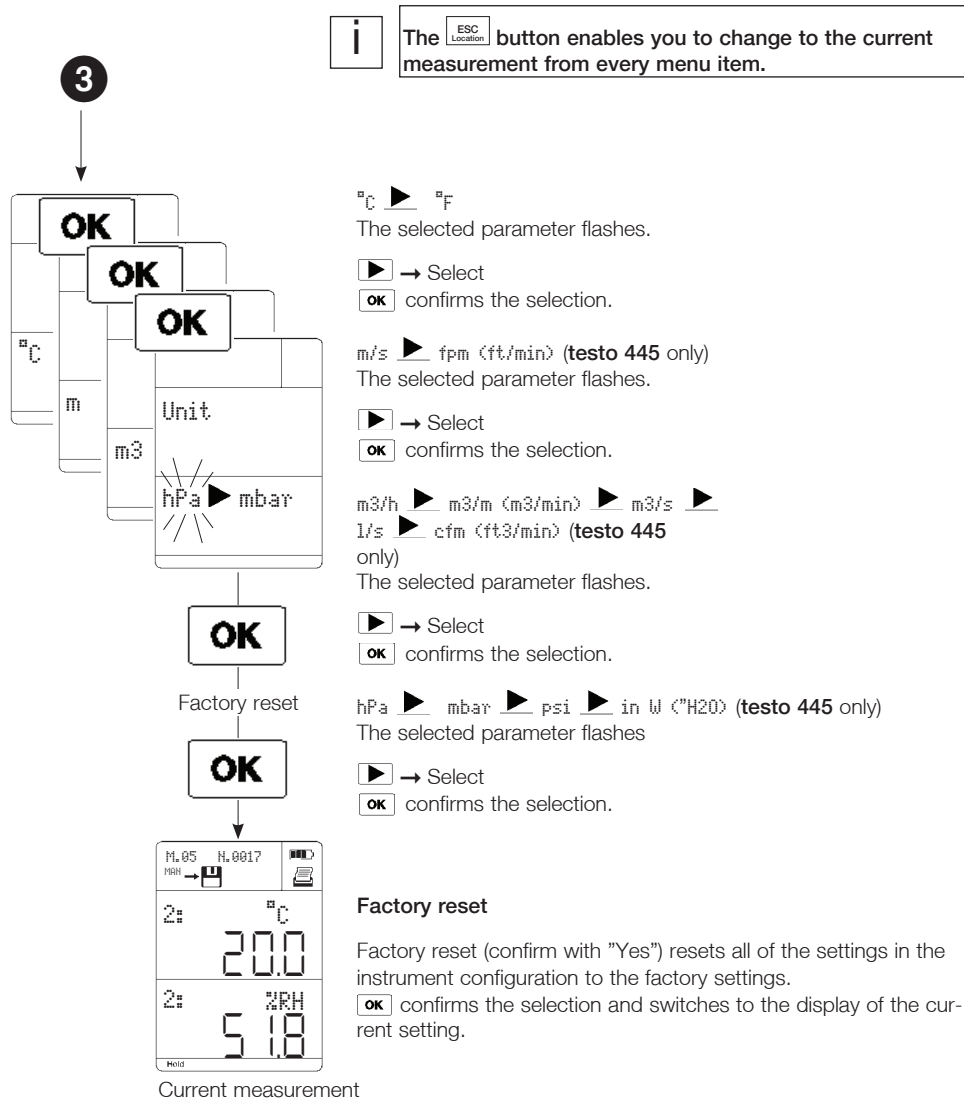

## 7. Velocity measurement

---

### Volume flow funnel (testo 445)

A volume flow funnel is needed to measure the volume flow in a ventilation opening (grid or outlet with dual wall clearance). The opening of the funnel must be covered completely by the grid (max. 190 x 190 mm with 0554.0400 or max. 350 x 350 mm with 0554.0410).

For the measurement, a velocity probe (0635.1041, 0628.0005 or 0635. 9540) is placed in the funnel's hole, is positioned in the middle and is aligned. The probe is snapped into the funnel's handle. Connect the probe to the instrument and switch on.

Position the cursor on the m/s parameter (  or  ).

You will get to the "Parameter setting" menu by pressing  .

Press  to get the volume flow (m<sup>3</sup>/h) in the display.

Confirm the m<sup>3</sup>/h ON setting by pressing  .

Press  twice and confirm with  .

(funnel/=funnel factor).

Enter the factor for the funnel used by you:

Funnel factor for funnel with part no. 0554.0400 = 20

Funnel factor for funnel with part no. 0554.0410 = 22

Press the funnel tightly on the opening. You can accept the displayed reading as it is or you can carry out a timed mean calculation if the readings fluctuate.

## 7. Velocity measurement

### Pitot tube and pressure probe (testo 445)



The measuring range is not symmetrical when the measurement is carried out using differential pressure probes (see Technical data on page 35)

Connect silicone hose to the correct connection plug (observe + and - on the probes.)

When measuring velocity with the Pitot tube, it is better to use the 0638.1445 pressure probe on account of its optimum accuracy. The measuring range extends to approx. 40 m/s. Velocity  $v$  is calculated in the instrument using the pressure difference  $\Delta p$  in the Pitot tube and based on the following formula:

$$v \text{ [m/s]} = S \times \sqrt{\frac{200000 \times \Delta p \text{ [hPa]}}{\rho \text{ [g/m}^3\text{]}}}$$

Press **OK** to activate the conversion. The "Parameter setting" menu is displayed. m/s appears in the display when activated via the **▶** button. Confirm the m/s ON setting with **OK**. The next step is to decide, using the **▶** button, as to whether the volume flow is to be calculated immediately (m<sup>3</sup>/h ON) or not (m<sup>3</sup>/h OFF). Confirm input with **OK**.

Pitot tube factor S and the temperature, humidity and absolute pressure parameters required to automatically calculate density have to be set in the instrument configuration.

The Pitot tube factor for testo Pitot tubes is at a constant 1.00 and does not need to be changed. If non-Testo Pitot tubes are used, please ask your supplier for the factor and save it.

### Thermal anemometer probes (testo 445)

The measuring principle of thermal anemometers with a heated wire or heated ball sensor is based on the cooling down of the sensor element via the air flow. The sensor element is heated to 100 °C for this purpose. The power needed to keep the sensor constantly at this temperature is a measure of the strength of the flow. According to this measuring principle, this probe requires a heating up period after being switched on which appears as "Count Down" in the display. Measuring in accordance with this measuring principle depends on the ambient pressure. The absolute pressure can be set in the instrument configuration menu.

## CO/CO2 measurement (testo 445)

### CO measurement (testo 445)

The connected probe 0632.1247 is initialised during the switch-on phase ("Count Down" runs in the display). For this reason, the measuring instrument should only be switched on in an atmosphere free of CO. Values will be too low otherwise in subsequent measurements.

If you want to initialize the instrument while switched on, place the probe in an atmosphere free of CO. Press **OK** and confirm initialisation of the CO probe (CO=0) by pressing **OK** again.

Connect probe before switching on the instrument

The protective cap must be on the probe during the initialisation phase (otherwise risk of inaccurate measurements).



The initialisation cap should only be removed during the actual measurement and should be replaced directly afterwards (mechanical protection of sensor and adherence to accuracies).

Cigarette smoke influences the measurement (min. 50 ppm).

A smoker's breath influences the measurement by approx. 5 ppm.

Switch on - Initialisation phase (60 s).

The ambient CO probe is initialised during the initialisation phase.

- Remove yellow protective cap.
- Probe can be put in shirt pocket, for example. The direction of the flow on the probe influences the accuracy of the measurement. Optimum measured results are achieved by moving the probe gently back and forth. If the air blows head-on on the sensor, the values measured will be too high.

## CO<sub>2</sub> measurement

### CO<sub>2</sub> measurement (testo 445)

The 0632.1240 probe measures concentrations from 0 to 1 vol % CO<sub>2</sub>. The unit can be switched between ppm and vol% as described in "Parameter settings" on page 16.

The measuring principle is based on infrared absorption. The probe has a relatively high power consumption on account of its sensor. Use mains unit and rechargeable batteries for long-term measurements.

**Note: The correct reading is available 20 to 30 seconds after being switched on.  
The corresponding "Count Down" is displayed.**

If there are major changes in the concentration, the probe needs 30 - 60 seconds to adapt itself to the outside world. Gently swinging of the probe shortens the adaptation time.



Hold the probe as far away as possible from you to reduce the influence of the CO<sub>2</sub> level in your breath on the measurement.

#### Pressure offset

Please note that the CO<sub>2</sub> reading depends on absolute air pressure. This effect is compensated in the instrument. Enter the correct absolute pressure for the location in the "Instrument configuration" menu (see Chapter 6).

**Permissible ambient temperature: 0 to +50 °C**  
**Permissible storage temperature: -20 to +70 °C**

## Measuring absolute pressure

Absolute pressure is calculated from:

- **Elevation pressure (metres above NN)**

The annual mean is 1013 mbar at sea level, the higher the location above sea level, the lower the pressure.

- **Barometric pressure**

The annual mean is 1013 mbar regardless of height. This pressure can deviate from the annual mean by  $\pm 20$  mbar depending on the weather (see display on nearest barometer).

- **Differential pressure**

is the positive or negative pressure in the duct.

You can determine the annual mean air pressure value for your elevation using the following table and any additional fluctuation using a barometer or ask your weather station for the exact air pressure value.

Elevation M.S.L	Air pressure (mbar)	Elevation M.S.L	Air pressure (mbar)	Elevation M.S.L	Air pressure (mbar)	Elevation M.S.L	Air pressure (mbar)
0	1013	1250	871	2500	746	3750	636
50	1007	1300	866	2550	742	3800	632
100	1001	1350	861	2600	737	3850	628
150	995	1400	855	2650	732	3900	624
200	989	1450	850	2700	728	3950	620
250	983	1500	845	2750	723	4000	616
300	977	1550	840	2800	719	4050	612
350	971	1600	835	2850	714	4100	608
400	966	1650	830	2900	709	4150	604
450	960	1700	824	2950	705	4200	600
500	954	1750	819	3000	700	4250	596
550	948	1800	814	3050	696	4300	592
600	943	1850	809	3100	692	4350	588
650	937	1900	804	3150	687	4400	584
700	931	1950	799	3200	683	4450	580
750	926	2000	794	3250	678	4500	577
<b>800</b>	<b>920</b>	2050	789	3300	674	4550	573
850	915	2100	785	3350	670	4600	569
900	909	2150	780	3400	666	4650	565
950	904	2200	775	3450	661	4700	562
1000	898	2250	770	3500	657	4750	558
1050	893	2300	765	3550	653	4800	554
1100	887	2350	760	3600	649	4850	550
1150	882	2400	756	3650	644	4900	547
1200	877	2450	751	3700	640	4950	543
						5000	540

Table: Barometric elevation formula

## Determining absolute pressure

---

**Example:**

If you are at 800 m above mean sea level, you have an annual mean air pressure of 920 mbar.

The annual mean air pressure has to be reduced by 10 (910 mbar air pressure) to correspond to the barometer display (1003 mbar) and to the barometer's height offset (to 1013 hPa).

Add the difference between your ambient air pressure and the static process air pressure (e.g. positive pressure in an air duct which is to be measured - can be measured using the differential pressure probe at up to 100 mbar) to this (air) pressure value.

**Example:** We have measured an annual mean air pressure of 910 mbar. We will now add 90 mbar based on the static process pressure. We therefore assume an absolute air pressure in the measurement medium of 1000 mbar.

The table on page 31 is also saved in the Testo Comfort software. Absolute pressure can be calculated automatically using this software if the height above mean sea level, barometric pressure and differential pressure are entered. The calculated absolute pressure is then taken over by the instrument.

## Error messages

Error message	Cause	Remedy
Memory full	The memory is full	Clear memory
— — —	Measuring range has not been reached	The probe is not suitable for this measurement task. The measured values are outside the allowed measuring range. Remove probe from location.
+   — — — -	Measuring range has been exceeded	The probe is not suitable for this measurement task. The measured values are outside the allowed measuring range. Remove probe from location.
— — — — —	<p><b>1st possibility</b> Measuring range has been exceeded or has not been reached range. Remove probe from</p> <p><b>2nd possibility</b> Probe is not connected or is defect</p>	<p>Some probes cannot differentiate between not reaching or not exceeding a measuring measurement location. The probe is not suitable for this measuring task. The measured values are outside the measuring range allowed.</p> <p>Check if the probe is connected to the right socket and that the plug has been pushed in far enough. Turn instrument on and off again If the error message returns, please contact your nearest Testo service point.</p>

## Technical data - Instruments

testo 645/445

### testo 645/445

#### General technical data

<b>Memory space:</b>	Up to 3000 readings
<b>Power supply:</b>	Battery / rechargeable batt.
<b>Alternative:</b>	12 V mains unit Battery recharging in instr.
<b>Typical battery lifetimes:</b>	Temperature/humidity probes, pressure probes, vane probes: 30 to 45 h Thermal probes, CO2 probes, 3-function probe: >3 - 12 h Reduce the hour times by a factor of 5 if a 9V battery is used.
<b>Operating temperature:</b>	0 to +50 °C
<b>Storage temperature:</b>	-20 to +70 °C
<b>Weight:</b>	Approx. 255 g incl. batteries
<b>Other features</b>	- Automatic recognition of all connected probes - RS232 interface for data management (electrically isolated)

#### Temperature measurement

<b>Type K (NiCr-Ni)</b>	
<b>Measuring range:</b>	-200 to +1370 °C
<b>Accuracy* at 22 °C:</b>	±0.3 °C or ±0.5 % of reading (the larger value applies)
<b>Additional error over operating temperature range:</b>	±0.2 °C
<b>Resolution:</b>	0.1 °C

#### Type J (FeCu-Ni)

<b>Measuring range:</b>	-200 to +1000 °C
<b>Accuracy* at 22 °C:</b>	±0.3 °C or ±0.5 % of reading (the larger value applies)

<b>Additional error over operating temperature range:</b>	±0.2 °C
---	---------

<b>Resolution:</b>	0.1 °C
--------------------	--------

#### The following can also be connected:

<b>thermocouple:</b>	Type S (Pt Rh-Pt)
----------------------	-------------------

#### NTC

<b>Measuring range:</b>	-50 to +150 °C
<b>Accuracy*:</b>	±0.2 °C (-25 to +74.9 °C) ±0.4 °C (-50 to -25.1 °C/ +75 to +99.9 °C) ±0.5 % of reading (+100 to +150 °C)

<b>Resolution:</b>	0.1 °C
--------------------	--------

#### Humidity measurement

<b>Temperature:</b>	-20 to +180 °C
<b>Measuring range:</b>	0 to 100 %RH
<b>Resolution:</b>	0.1 %RH
<b>System accuracy*:</b>	Up to 1.0 %RH (see probe data)
<b>Calc. humidity parameters:</b>	td, g/m <sup>3</sup> , g/kg, J/g (pressure-compensated)

#### Warranty

Instruments	2 years
Probes	1 year
Terms of warranty:	see website <a href="http://www.testo.com/warranty">www.testo.com/warranty</a>

## Technical data - Instruments

testo 645/445

### testo 645

#### Temperature measurement

**Pt100**  
**measuring range:** -200 to +800 °C  
**Accuracy\*** ±0.2 °C or ±0.1 % of reading  
**at 22 °C:** (the larger value applies)

**Additional error over operating temperature range:** ±0.1 °C  
**Resolution:** 0.1 °C

### testo 445

#### Velocity measurement

**Vane**  
**Measuring range:** 0 to 60 m/s  
**Resolution:** 0.01 m/s  
**Accuracy:** See probe data

**Thermal anemometer**  
**Measuring range:** 0 to 20 m/s  
**Resolution:** 0.01 m/s (0 to 10 m/s)  
 0.1 m/s (remaining range)  
**Accuracy:** See probe data

**Pitot tube**  
**Measuring range:** 0 to 10 mbar / 0 to 100 mbar  
 0 to 40 m/s / 0 to 100 m/s  
**Resolution:** 0.01 m/s  
**Accuracy:** See probe data

**Volume flow in m<sup>3</sup>/h, m<sup>3</sup>/min, l/s, cfm (ft<sup>3</sup>/min)**  
**Measuring range:** 99,999 m<sup>3</sup>/h

#### Pressure measurement

Measuring range:	Resolution:	Accuracy*:
-40 to 100 mbar	0.01 mbar	±0.1 mbar (0 to 20 mbar) 1 % of reading (rem. range)
-4 to 10 mbar	0.001 mbar	±0.01 mbar
2000 mbar	1 mbar	±2 mbar

**Pressure units can be switched:**  
 mbar, psi; in W("H<sub>2</sub>O)

**Calculated velocity values density compensated:** 0 to 100 m/s

**Calculated volume flow values:**  
 m<sup>3</sup>/h, m<sup>3</sup>/min, l/s, cfm (ft<sup>3</sup>/min)

#### CO<sub>2</sub> measurement

**Measuring range:** 0 to 10000 ppm  
 0 to 1 vol. %

**Resolution:** 1 ppm  
 0.0001 vol. %

**Accuracy\*:** ±50 ppm ±2 % of reading  
 (0 to 5000 ppm)  
 ±100 ppm ±3 % of reading  
 (remaining range)

#### CO measurement

**Measuring range:** 0 to 500 ppm

**Resolution:** 1 ppm

**Accuracy\*:** ±5 ppm (0 to 100 ppm)  
 ±5 % of measured value  
 (remaining range)

\* **Accuracy:** ±1 digit

## Ordering data

### Measuring instruments/Accessories/Probes for testo 645 / 445

Measuring instruments	Part no..
testo 645 humidity measuring instrument, with TopSafe 2 channel temperature (type K/J/S, NTC, Pt100 thermocouples) and humidity measuring instrument, with battery and calibration protocol	0563 6450
testo 445 multi-function measuring instrument, with TopSafe 2 channel multi-function measuring instrument for temperature (type K/J/S thermocouples), humidity, velocity, pressure, CO <sub>2</sub> , CO with battery and calibration protocol	0560 4450
<b>Accessories</b>	
<b>Software</b>	
Comfort software "Professional" for data management, incl. data base, convenient analysis and graphics function	0554 0274
RS232 cable to connect measuring instrument - PC for the transfer of data	0409 0178
<b>TopSafe / Cases</b>	
TopSafe protects instrument from dirt, water (IP 65) and impact - dishwasher-proof - with bench stand, belt clips and probe clips to attach probe to TopSafe	0516 0440
System case, plastic for instrument, probes and additional accessories Clear layout of case contents by placing probes in lid.	0516 0400
System case, aluminium for instrument, probes and additional accessories. Clear layout of case contents by placing probes in lid.	0516 0410
<b>Additional accessories</b>	
9 V rechargeable battery for testo 445, testo 645 measuring instruments	0515 0025

PT 100-probes	Meas. range / Accuracy	t <sub>99</sub> sec.	Connection cable	Part no..
Standard immersion/penetration probe Pipe: stainless steel	-200...+400°C, Class A	20	Plug-in head	0604.0273
Highly accurate immersion/penetration probe	-100...+350°C, 1/5, Class B	30	Plug-in head)	0628.0015*
Flexible precision immersion probe, cable between handle and tip, heat-proof up to +300 °C	-100...+265°C, 1/5, Class B	80	Plug-in head	0628.0016*

\* With EEPROM: Precision adjustment for each probe at a measuring point

## Ordering data

### Fühler für testo 645 / 445

NiCr-Ni probes	Meas. range / Accuracy	t <sub>90</sub> sec.	Connection	Part no.
Quick-action surface probe with sprung thermocouple strip	-200...+300°C, Short-term up to +500 °C, Class 2	3	Plug-in head (Please order connection cable 0430.0143)	0604 0194
Spare measuring head for pipe clamp probe, for pipes with a 2" diameter	-60...+130°C, Class 2	5	1,5 m, PVC	0602 0092
Rapid response immersion/penetration probe	-200...+400°C, Class 1	3	Plug-in head (Please order connection cable 0430.0143)	0604.0293
Quick action immersion/penetration probe for measurements in liquids	-200...+600°C, Class 1	1	Plug-in head (Please order connection cable 0430.0143)	0604.0493
Quick action immersion/penetration probe for high temperatures	-200...+1100°C, Class 1	1	Plug-in head (Please order connection cable 0430.0143)	0604.0593
Quick action immersion/penetration probe for measurements in gases and liquids with a slim tip, low in mass	-200...+600°C, Class 1	<1	Plug-in head (Please order connection cable 0430.0143)	0604.9794
Plug-in measuring tips Ø 3 for high temperatures, bendable a) Stainless steel outer coating 1.4541 L 750 b) Stainless steel outer coating 1.4541 L 1200 c) Inconel outer coating 2.4816 L 550 d) Inconel outer coating 2.4816 L 1030	-200..+900 °C -200..+900 °C -200..+1100 °C -200..+1100 °C	3,5 3,5 3,5 3,5		0600.5393 0600.5493 0600.5793 0600.5893
Handle for plug-in measuring tips			coiled cable PUR	0600 5593
<b>Accessories for NiCr-Ni probes</b>				
Adapter to connect NiCr-Ni thermocouples and probes with open wire ends			0.3 m, PVC	0600.1693
Silicone heat paste (14g), Tmax = +260 °C to improve heat transfer in surface probes				0554.0004
Connection cable for probes			Length 1,5 m, PUR	0430.0143
Connection cable for probes with plug-in head			Length 5,0 m, PUR	0430.0145
Extension cable between plug-in cable and instrument			Length 5,0 m, PUR	0409.0063

## Ordering data

### Probes for testo 645 / 445

Humidity/temperature probes	Measuring range	System accuracy*	t <sub>99</sub> sec.	Connection cable	Part no.
Standard indoor air quality probe up to +70 °C	0 to 100 %RH, probe tip), -20 to +70°C	±2 %rH (2 to 98 %rH) ±0,4°C (0 to 50°C) ±0,5 °C (rem. range)	<12 at 2m/s	Plug-in head (Please order connection cable 0430.0143)	0636 9740
Highly accurate reference humidity/temp. probe incl. calibration certificate	0 to 100 %RH, probe tip), -20 to +70°C	±1%rH (10 to 90 %rH from +15 to +30°C) ±2%rH (rem. range plus Tcomp.) ±0,4°C (0 to 50°C) ±0,5°C (rem. range)	<12 at 2m/s	Plug-in head (Please order connection cable 0430.0143)	0636 9741
Robust humidity probe e.g. for measuring material moisture equilibrium or for measurements in exhaust ducts up to +120 °C	0 to 100 %rH -20 to +120°C	±1%rH (10 to 90 %rH from +15 to +30°C) ±2%rH (rem. range plus Tcomp.) ±0,4°C (0 to 50°C) ±0,5°C (rem. range)	<30 at 2m/s	Plug-in head (Please order connection cable 0430.0143)	0636 2140
Robust high temperature probe up to +180 °C	0 to 100 %rH -20 to +180°C	±1%rH (10 to 90 %rH from +15 to +30°C) ±2%rH (rem. range plus Tcomp.) ±0,4°C (0 to 50°C) ±0,5°C (rem. range)	<30 at 2m/s	Plug-in head (Please order connection cable 0430.0143)	0628 0021
Flexible humidity probe, does not retain shape for measurements in inaccessible places	0 to 100 %rH -20 to +180°C	±2 %rH (2 to 98 %rH) ±0,4°C (0 to 50°C) ±0,5 °C (rem. range)	<30 at 2m/s	Plug-in head (Please order connection cable 0430.0143)	0628 0022
Pressure-tight probes for measuring remaining, e.g. in compressed air systems	0 to 100 %rH -30 to +50°C t <sub>pd</sub>	-30 to +50°C t <sub>pd</sub> ±0,9 to ±4°C t <sub>pd</sub>	1 to 5 min typically 2 min	Plug-in head (Please order connection cable 0430.0143)	0636 9840
Flexible, humidity probe (retains shape) for measurements in inaccessible places	0 to 100 %rH -50 to +50°C t <sub>pd</sub>	-40 to +50°C t <sub>pd</sub> ±0,8 to ±4°C t <sub>pd</sub>	1 to 5 min typically 2 min	Plug-in head (Please order connection cable 0430.0143)	0636 9841

\* Accuracy data at rated temperature of +25 °C, temperature coefficient ± 0.03% / °C

## Ordering data

### Probes for testo 645 / 445

Accessories for humidity/temperature probes, 3-function probe	Diameter	Part no.
Caps for all humidity probes		
Metal protection cage, material: stainless steel V4A. Quick adjustment time, robust and temperature-proof. Application: for velocities < 10 m/s	21 mm 12 mm	0554 0665 0554 0755
Cap with wire mesh filter.	12 mm	0554 0757
PTFE sintered filter, PTFE material. Not affected by condensation, water-repellent, resistant to corrosive substances. Applications: compressed air measurements, high humidity range (long-term measurements), high velocities.	21 mm 12 mm	0554 0666 0554 0756
Stainless steel sintered cap, material: V2A stainless steel. Very robust, suitable for penetration, should be cleaned with fresh air, mechanical protection of sensor. Application: large mechanical loads, high velocities.	21 mm 12 mm	0554 0640 0554 0647
Additional accessories		
Connection cable for probes with plug-in head, 1.5 m long, PUR coating material		0430 0143
Connection cable for probes with plug-in head, 5 m long, PUR coating material		0430 0145
Extension cable between plug-in head cable and instrument, 5 m long, PUR coating material		0409 0063
Telescope for probes with plug-in head, extension length: maximum 1 m, cable: 2.5 m, PUR coating material		0430.0144
Control and adjustment set 11.3 % / 75.3 % for humidity probes and 3-function probe (please order 0554.0661 adapter for 3-function probe)		0554 0660
Control and storage humidity (33 %) for humidity probe and 3-function probe		0554 0636

Pressure probes	Measuring range	Accuracy	Connection cable	Part no..
Pressure probe for measuring velocities and differential pressure or absolute pressure	-4 to 10 hPa	±0,03 hPa	1,5 m, PUR	0638.1445
	-40 to 100 hPa	±0,1 hPa (0 to 20hPa)		0638.1545
	2000 hPa (Abs.p)	±0,5% of m.v. (rem.) ±5 hPa		0638.1645
Accessories for pressure probes	Temp.max	Material	Length / Ø	Part no..
Pitot tubes to measure velocity (in connection with pressure probes); longer versions on request	+350 °C	Chromium-plated brass	500 mm/7 mm	0635.2045
	+350 °C	Chromium-plated brass	350 mm/7 mm	0635.2145
Silicone hose to connect Pitot tube and pressure probe, 5 m long				0554.0440

## Ordering data

Probes for testo 645 / 445

Velocity probes	Sensor	Meas. range	Accuracy (System)	Part no..
Vane/temperature probe, can be attached to handle or telescope		0,6 to 60 m/s -30 to +140 °C	±(0,2 m/s +1 % of m.v.)	0635 9540
Vane/temperature probe, can be attached to handle or telescope		0,6 to 40 m/s -30 to +140 °C	±(0,2 m/s +1 % of m.v.)	0635 9640
Bendable vane probe for integrated velocity measurement Range of application: -20 to +60 °C		0,25 to 20 m/s	±(0,1 m/s +1,5 % of m.v.)	0635 9440
Bendable vane probe for integrated velocity measurement Range of application: -20 to +60 °C		0,25 to 15 m/s	±(0,1 m/s +1,5 % of m.v.)	0635 9340
Low cost, robust hot bulb probe for measurements in the lower velocity range	Hot bulb NTC	0 to 10 m/s -20 to +70 °C	±(0,03 m/s +5% of m.v.)	0635 1549
Robust hot bulb probe with handle and telescope for measurements in the lower velocity range	Hot bulb NTC	0 to 10 m/s -20 to +70 °C	±(0,03 m/s +5% of m.v.)	0635 1049
Quick-reaction hot wire probe with telescope for measurements in the lower velocity range with direction recognition function	Hot bulb NTC	0 to 20 m/s -20 to +70 °C	±(0,03 m/s +4% of m.v.)	0635 1041
Flügelrad-Meßsonde mit Teleskop, T <sub>max</sub> +60°C	Vane	0,4...40 m/s	±(0,2 m/s , +2 % of m.v.).	0628 0005
High temperature probe with handle for long-term measurements up to +350 °C	Vane, NiCr-Ni	0,6 to 20 m/s -40 to +350 °C	±2,5 % of final value	0635 6045
Accessories for velocity probes	Meas. range	Dimension	Connection cable	Part no.
Telescope for plug-in vane probes, max. 1 m long			2,3 m Silicon	0430 0941
Handle for plug-in vane probes			1,5 m Silicon	0430 3545
Volume flow funnel to measure the extraction capacity in ventilation systems	b) 20 to 400 m <sup>3</sup> /h	350x350 mm		0554 0410
Extension cable between connection cable and instrument for plug-in vanes			5 m, PUR	0409 0063

## Ordering data

Probes for testo 645 / 445

Additional probes	Sensor	Meas. range	Accuracy	Part no.
3-function probe for simultaneous measurement of Temperature, humidity and velocity. With plug-in head (please order 0430.0143 connection cable)	Hot bulb Capacitive  NTC	0 to 10 m/s 0 to 100 %rF (probe tip) -20 to +70 °C	±(0,03 m/s +5 % v.Mw.) ±2 %rF (2 to 98 %rF)  ±0,4 °C (0 to 50 °C) ±0,5 °C (rem. range)	0635 1540
Comfort level probe for meas. degree of turbulence, with telescope and stand. Fulfills the requirements of DIN 1946 Part 2 or VDI 2080	Hot bulb NTC	0 to 5 m/s 0 to 50 °C	±(0,03 m/s +4 % v. Mw.) ± 0,3 °C	0628 0009
CO <sub>2</sub> probe for measuring indoor air quality and for monitoring workplace conditions		0 to 10.000 ppm 0 to 1Vol.%	±50 ppm ±2 % of m.v. (0 to 5000 ppm) ±100 ppm ±3 % of m.v. (rem. range)	0632 1240