



testo 882 · Thermal imager

Instruction manual



1	Contents	
1	Contents	3
2	Safety and the environment	4
	2.1. About this document	4
	2.2. Ensure safety	5
	2.3. Protecting the environment	6
3	Specifications	7
	3.1. Use	7
	3.2. Technical data	8
4	Product description	13
	4.1. Overview	13
	4.2. Basic properties	14
5	First steps	16
	5.1. Commissioning	16
	5.2. Getting to know the product	18
6	Using the product	24
	6.1. Menu functions	24
	6.1.1. Measuring functions	24
	6.1.2. Image gallery	28
	6.1.3. Scale	29
	6.1.4. Display	30
	6.1.5. Emissivity	30
	6.1.6. Palette	33
	6.1.7. Configuration	33
	6.2. Measuring	38
7	Maintaining the product	42
8	Tips and assistance	44
	8.1. Questions and answers	44
	8.2. Accessories and spare parts	45

2 Safety and the environment

2.1. About this document

Use

- > Please read this documentation through carefully and familiarize yourself with the product before putting it to use. Pay particular attention to the safety instructions and warning advice in order to prevent injuries and damage to the products.
- > Keep this document to hand so that you can refer to it when necessary.
- > Hand this documentation on to any subsequent users of the product.

Warnings

Always pay attention to information that is marked by the following warnings with warning pictograms. Implement the specified precautionary measures.

Representation	Explanation
 WARNING	Indicates potential serious injuries
NOTICE	indicates circumstances that may lead to damage to the products

Symbols and writing standards

Representation	Explanation
i	Note: Basic or further information.
1. ... 2. ...	Action: more steps, the sequence must be followed.
> ...	Action: a step or an optional step.
- ...	Result of an action.
Menu	Elements of the instrument, the instrument displays or the program interface.

[OK]	Control keys of the instrument or buttons of the program interface.
... ...	Functions/paths within a menu.
“...”	Example entries

2.2. Ensure safety

- > Only operate the product properly, for its intended purpose and within the parameters specified in the technical data. Do not use any force.
- > Do not operate the instrument if there are signs of damage at the housing, mains unit or feed lines.

The thermal imager must not be directed at the sun or other sources of intense radiation (e.g. objects with temperatures greater than 500 °C, 800 °C while using the high-temperature filter) during operation. This may lead to serious damage to the detector. The manufacturer accepts no warranty for this type of damage to the microbolometer detector.

- > The objects to be measured or the measurement environment may also pose risks: Note the safety regulations valid in your area when performing the measurements.
- > Do not store the product together with solvents. Do not use any desiccants.
- > Carry out only the maintenance and repair work on this instrument that is described in the documentation. Follow the prescribed steps exactly. Use only original spare parts from Testo.
- > Improper use of rechargeable batteries can lead to destruction or injuries by means of current surges, fire or escaping chemicals. The following instructions must be observed to avoid such hazards:
 - Only use in accordance with the directions in the instruction manual.
 - Do not short, take apart or modify.
 - Do not expose to heavy impacts, water, fire or temperatures above 60 °C.
 - Do not store in the proximity of metal objects.
 - Do not use leaky or damaged rechargeable batteries. In the event of contact with battery acid: Thoroughly wash affected area with water and consult a doctor, if necessary.

- Only charge in the instrument or the recommended charging station.
- Immediately stop the charging process if this is not completed in the given time.
- In the event of improper function or signs of overheating, immediately remove the rechargeable battery from the measuring instrument/charging station. Caution: Rechargeable battery may be hot!
- During longer breaks, remove the battery from the instrument to avoid exhaustive discharge.

2.3. Protecting the environment

- > Dispose of faulty rechargeable batteries/spent batteries in accordance with the valid legal specifications.
- > At the end of its useful life, send the product to the separate collection for electric and electronic devices (observe local regulations)

3 Specifications

3.1. Use

The testo 882 is a handy and robust thermal imager. It opens the door to contactless determination and illustration of the temperature distribution on surfaces for you.

Typical areas of application are:

- Building inspection (heating, ventilation and air conditioning trade, company technicians, engineering offices, experts): Energy evaluation of buildings
- Preventative maintenance (servicing): Mechanical and electrical inspection of systems and machines
- Production monitoring (quality assurance): Monitoring production processes

Basic properties:

- High-quality wide-angle lens 32° x 23°, detector 320 x 240, NETD < 50 mK, 2 GB SD card for approx. 1000 images, minimum focus distance 20 cm, integrated digital camera with power LEDs for illumination, dynamic motorfocus, isotherm, min./max. on area, audio comments, display of surface moisture distribution (real-time display with optional radio humidity probe), high-temperature filter (optional)

Export control

Thermal imagers may be subject to the export restrictions of the European Union.

The testo 882 with 33 Hz in particular can only be exported to countries outside of the European Union with an export permit from the authorities.

Please observe the national regulations for export control when exporting.

3.2. Technical data

Infrared image output

Characteristic	Values
Field of vision/min. focusing distance	Standard lens: 32° x 23°/0.2 m (0.66 ft)
Thermal sensitivity (NETD)	<50 mK at 30 °C (86 °F)
Geometric resolution	Standard lens: 1.7 mrad
Refresh rate	33 Hz within EU, 9 Hz outside of EU
Focus	manual + motorized
Detector type	FPA 320 x 240 pixels, a.Si
Spectral range	8 - 14 µm

Visual image output

Characteristic	Values
Field of vision/min. focusing distance	33° x 25°/0.4 m (1.31 ft)
Image size	640 x 480 pixels
Refresh rate	8 to 15 Hz

Image presentation

Characteristic	Values
Image display	3.5" LCD with 320 x 240 pixels
Display options	Infrared image/real image/infrared and real image
Video stream	25 Hz
Colour palettes	9 options

Measuring	
Characteristic	Values
Temperature range (can be changed)	Measuring range 1: -20 - 100 °C (-4 - 212 °F) Measuring range 2: 0 - 350 °C (32 - 662 °F) Measuring range 3: 350 - 550 °C (662 - 1022 °F)
Accuracy	With measuring range 1 activated, for readings within the range of -20 - 100 °C (-4 - 212 °F): ±2 °C (±3.6 °F) With measuring range 2 activated, for readings within the range of 0 - 350 °C (32 - 662 °F): ±2 °C (±3.6 °F) or ±2 % of reading (whichever is the greater) With measuring range 3 activated, for readings within the range of 350 - 550 °C (662 - 1022 °F): ±3 % of reading
Reproducibility	±1 °C (±1.8 °F) or ±1 % (whichever is the greater)
Measuring point minimum diameter	5 mm at 1 m
On-time (time to image)	30 s
Humidity and ambient temperature measurement with radio probe (optional)	0...100%rF, -20...70°C (-4...158°F)
Accuracy of radio probe (optional)	±2%rF, ±0,5°C (0,9°F)
Measuring functions	Standard measurement (1-point), 2-point measurement, Cold-/Hotspot, isotherm, min./max. on area, Display of humidity image via manual entry of the ambient humidity/temperature (real-time display with optional radio humidity probe), solar (manual entry of the radiation intensity)

3 Specifications

Characteristic	Values
Compensation for reflected temperature	manual
Setting emissivity	0.01...1.00

Image storage

Characteristic	Values
File format	.bmt Export options in .bmp, .jpg, .csv
Removable memory	SD card
Memory capacity	Scope of delivery: 2 GB (approx. 1000 images)

Lens

Characteristic	Values
Wide-angle lens	32° x 23°
Aperture	0.95

Laser measuring spot marking

Characteristic	Values
Classification of the laser	635 nm, Class 2

Audio functions

Characteristic	Values
Sound recording/playback	via headset (included in delivery)
Recording period	max. 30 s per image

Power supply

Characteristic	Values
Battery type	Fast-charging, Li-ion battery can be changed on-site
Operating time	approx. 4 h at 20 - 30 °C (68 - 86 °F)
Charging option	In instrument/in charging station (optional)
Mains operation	Yes, with mains unit 0554 8808
Mains unit output voltage	5 V/4 A

Ambient conditions

Characteristic	Values
Operating temperature	-15 - 40 °C (5 - 113 °F) for measuring range 1 and 2 0 - 40 °C (32 - 113 °F) for measuring range 3
Storage temperature	-30 - 60 °C (-22 - 140 °F)
Air humidity	20 - 80 %RH, not condensing
Enclosure rating of the housing	IP54 (Interface terminals closed, battery connected, lens mounted)

Physical features

Characteristic	Values
Weight	900 g (including battery)
Dimensions	152 x 108 x 262 mm (5.98 x 4.17 x 10.31")
Tripod mounting	Yes, with adapter (included in delivery)
Housing	ABS
Enclosure rating of the housing	IP54 (Interface terminals closed, battery connected, lens mounted, softcase mounted)
Vibration	max. 2 G

3 Specifications

Standards, tests, warranty

Characteristic	Values
EU Directive	2014/30/EC
Vibration	IEC 60068-2-6
Warranty	2 years, warranty conditions:

4 Product description

4.1. Overview

Product components

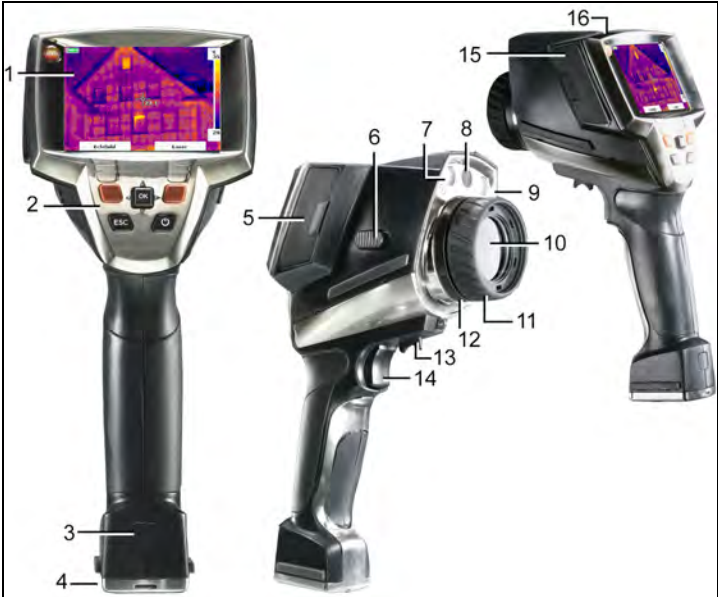

- 1 Display.
- 2 Control keys:

Key	Functions
[Power]	Switch the imager on/off.
[OK] and Joystick	<ul style="list-style-type: none"> • Press [OK]: Open menu, confirm selection/setting. • Move [OK] up/down/right/left = Joystick function: Select functions, navigate
[Esc]	Cancel action.
Left/right ["xy"] quick select button	Call up a function. The function assigned to the quick select button at any one time is shown in the display.

- 3 Instrument rechargeable battery lock release button.
- 4 Metric thread: For fastening the included tripod adapter.
Do not use desktop tripods, danger of tilting!
- 5 Right interface terminal: Radio module compartment.
- 6 **[Motor focus switch]**: To switch the motor focus on/off.
- 7 2 LEDs: For illumination for the visual image.
- 8 Digital camera lens: For recording visual images
- 9 Laser: For aiming at the measuring field.



Laser radiation. Do not look into the beam.

CLASS 2 LASER

- 10 Infrared camera lens: For recording thermography images.
- 11 **Rotating ring** Manual focusing: For manual focusing.
Only use rotating ring with motor focus switched off to prevent damage to the auto mechanism.
- 12 **Lens lock ring**
- 13 **[Motor focus control]**: For motorized focusing
- 14 **[Trigger]**: For recording (freezing/saving) images.
- 15 Left interface terminal: Memory card slot. Headset slot. USB interface. Mains socket, for connecting the included mains unit. Buffer battery slot.
- 16 Status LED: off (no mains unit connected), flashes (mains unit connected and rechargeable battery charging), lights up (mains unit connected and battery charging process completed).

4.2. Basic properties

Voltage supply

The power is supplied to the instrument via an exchangeable rechargeable battery or via the included mains unit.

With an attached mains unit, the power is supplied automatically via the mains unit and the instrument's rechargeable battery is charged (only at ambient temperatures from 0 to 45 °C).

Charging the battery is also possible using a desktop charging station (accessory).

The instrument is equipped with a buffer battery (type CR 1632) to maintain the system data during an interruption in the power supply (e.g. when the battery is changed).

File formats and file names

The images are saved according to the following pattern:

XX_YYYYY.ZZZ

XX: **IV** for IR/humidity image with relevant real image, **VI** for real image.

YYYYY: 5-digit consecutive number

ZZZ (file extension): **BMT** for IR/humidity image with relevant real image, **BMP** for real image.

5 First steps

5.1. Commissioning

Connect rechargeable battery

The thermal imager is delivered with a rechargeable battery that is inserted in the rechargeable battery slot but not connected.

- > Push the battery all the way into the rechargeable battery slot until this is flush with the bottom of the handle.

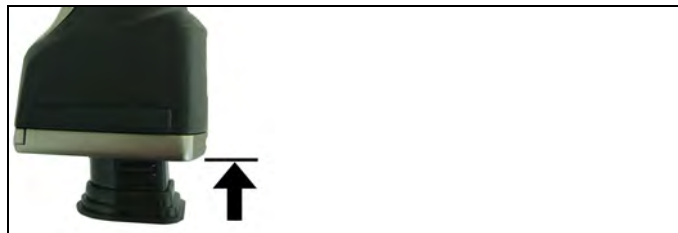

- The thermal imager starts automatically.

Perform basic settings

- > Remove the protective film from the display.
- The start screen appears on the display.
- The **Landeseinstellungen (Country settings)** dialogue is opened.

Instrument language (**Language**) and temperature unit (**Unit**) can be set.

1. Move **Joystick** up/down to select the desired option.
 - The selected option has an orange border.
2. Confirm the selection with **[OK]**.
 - The selected setting is highlighted orange (□). The arrows (↕) show that the setting can be changed.
3. Move **Joystick** up/down to change the setting.
4. Confirm the entry with **[OK]**.
5. Confirm the settings with **Übernehmen (Apply)**.
6. Press **[⏻]** to switch off the thermal imager.

Initial charging of rechargeable battery

The thermal imager is delivered with a partially charged battery. Completely charge the battery before use.

> Connect the country-specific adapter required for the existing mains to the mains unit.

1. Open the cover on the left side of the thermal imager (1).
2. Connect the mains unit to the mains socket (2).

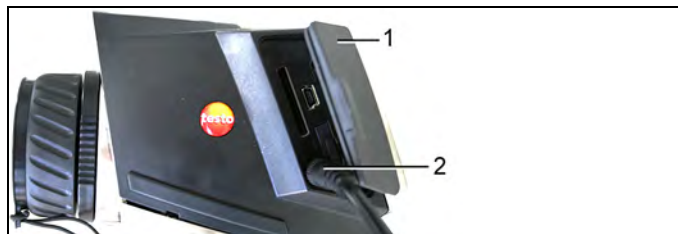

3. Connect the mains plug to a mains socket.
 - The thermal imager starts automatically.

i For battery charging, the imager can remain switched on or be switched off. This has no influence on the duration of charging.

- The charging of the rechargeable battery begins.
 - The charging status is displayed by the status LED:
 - LED flashing: Charging
 - LED on: Battery charged, charging finished
- 4. Charge the battery fully, then disconnect the instrument from the mains unit.
 - After the initial charging of the battery, the thermal imager is ready for operation.

Charging the battery is also possible using a desktop charging station (accessory).



Rechargeable battery care:

- Do not fully exhaust rechargeable batteries.
 - Store rechargeable batteries only in charged condition and at low temperatures, but not below 0°C (best storage conditions with a charge level of 50-80%, at an ambient temperature of 10-20°C, recharge completely before use).
 - During longer breaks, you should discharge and recharge the batteries every 3-4 months. Trickle charging should not exceed 2 days
-

5.2. Getting to know the product

Insert the memory card

1. Open the cover on the left side of the thermal imager.
2. Insert memory card (SD card) into the card slot (SD) (1).



- > To remove the memory card: Press on the memory card to release the lock.

Insert radio module (accessories)

Using a radio module (accessory) the instrument can be connected with a radio humidity probe. The radio module must be connected before switching on the instrument in order for the instrument to be identified.



Radio probes may only be used in countries in which they are permitted (see instructions for use of radio probe).

- > Switch off instrument before inserting the radio module.
1. Open the cover on the right side of the thermal imager.
 2. Release the lock (1) and open the retaining clip (2).
 3. Insert radio module into the module slot (3).

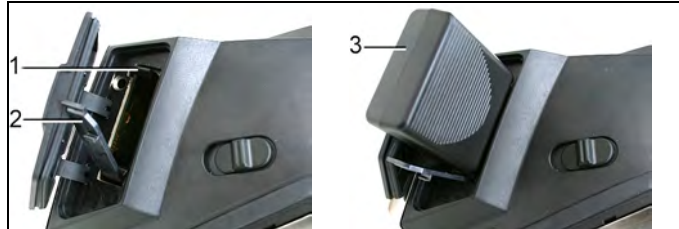

- > To remove the radio module: Press the radio module down and pull out.

Attaching headset

1. Open the cover on the left side of the thermal imager.
2. Insert stereo jack of the headset into the headset slot (1).



Mount/remove infrared protection glass

Installation:

1. Attach the protection glass (with black fitting) fastened to the red mounting ring to the lens and turn the mounting ring clockwise to the stop.
2. Remove the red mounting ring from the protection glass.

Removal:

1. Attach the red mounting ring to the protection glass.
2. Turn the mounting ring anticlockwise and remove the protection glass.

After mounting/removing the protection glass, activate or deactivate the **Protection glass** option, see Optics..., page 34. If this option is set incorrectly, the specified measuring accuracy is not ensured.

Mounting/removing high-temperature filter

Installation:

1. Attach the high-temperature filter (with red fitting) fastened to the red mounting ring to the lens and turn the mounting ring clockwise to the stop.
2. Remove the red mounting ring from the high-temperature filter.

Removal:

1. Attach the red mounting ring to the high-temperature filter.
2. Turn the mounting ring anticlockwise and remove the high-temperature filter.

Activate/deactivate the high-temperature measuring range (**350.0 - 550.0 °C** or **662.0 - 1022 °F**), Measuring range page 27, after mounting or removing the high-temperature filter, otherwise the specified measuring accuracy is not ensured

Mount tripod adapter

Using the included tripod adapter, the imager can be fastened to the testo tripod (accessory) or to a commercially available standard tripod. With the tripod adapter mounted, the battery cannot be changed!

1. Place the tripod adapter on the lower end of the handle and screw on using the included Allen key (ISO 2936, size 4).
2. Slide thermal imager into the fastening plate of the testo tripod and lock or fasten it to the commercially available standard tripod (screw-type fastening).

Mounting Softcase

The Softcase combines the functions of instrument protection, Sun Shield and carrying function (strap).

1. Set the Softcase on the imager from above (1) and pull both sides of the Softcase down around the display (2).
2. Guide Velcro strip through the two plates (3) and close (4).



Switch the imager on/off

1. Remove protection cap from the lens.
2. Press **[⏻]**.
 - The start screen appears on the display. The type designation of the imager and the firmware version are shown.
 - The measurement view is opened after the warm-up period.
 - The imager performs an automatic zeroing approx. every 60 sec. This can be recognized by means of a "click". The image is frozen briefly when this occurs.
- > To switch off: Press **[⏻]**.
 - The display goes out and the imager is switched off.

Focus image using motor focus

- > Slide **[Motor focus switch]** towards the display (position: ⚙️).
- > Move **[Motor focus control]** until the image is in focus.

Manually focusing the image

NOTICE

Possible damage to the auto mechanism!

- > Only use **Rotating ring** with the motor focus switched off.
- > Slide **[Motor focus switch]** towards the lens (position: 🖐️).
- > Turn **Rotating ring** of the lens until the image is in focus.

Record (freeze/save) image

1. Press **[Trigger]**.

- The image is frozen (fixed image).

If the image is to be saved, the desired storage location can be set using the left **[Folder]** quick select button, see Select the storage location (folder): page 39.

- Infrared image or infrared/real image is shown: Infrared image is saved, real image is saved in the same file as an attachment to the infrared image (even when saving in infrared image mode)¹.
 - Real image is shown: Real image is saved.
2. Save image: Press **[Trigger]** again, or: Press **[OK]**.
or
Discard image: Press **[ESC]**.

Getting to know the quick select buttons

The quick select buttons can be assigned functions that are required often so that you can call them up directly.

Factory settings:

- Left quick select button: **[Scale]**.
- Right quick select button: **[Laser]**.

 WARNING
Eye damage due to laser beam!
> Do not look into the laser beam.
> Do not point the laser beam at people.

Changing assignment of the quick select buttons

1. Move **Joystick** left or right to open the **Configure key** function list for the left or right quick select button.
2. Move **Joystick** up/down to select the desired function.

¹ All saved images are shown in picture-in-picture mode in the gallery.

Function	Description
Image type	Change display mode: Infrared image, real image or infrared/real image. ²
Laser	Switch on laser for homing in on the measuring surface (hold button down). ³
Light	Switch on/off LEDs for lighting up objects for the digital camera.
Palette	Change colour palette for the infrared image.
Emissivity...	Set emissivity and reflected temperature.
Scale...	Set scale limits.
Adjustment	Perform manual zero point calibration.

3. Press **[OK]** to activate the selected function.

Navigating in the menu

1. Press **[OK]** button.
 - The **Menu** is opened.
2. Select navigation/function:
 - Move **Joystick** up or down to select the menu item.
 - Press **[OK]** to confirm the selection. Or for menu items that are marked with an arrow (▶): Move **Joystick** to the right.
 - Move **Joystick** to the left to return to the previous menu level.
 - Press **[OK]** to select the function.
 - Press **[ESC]** to cancel the process and change to Measuring Mode.
- Depending on the selected menu item, press **[OK]** to perform a setting or open a submenu/dialogue, see Menu functions, page 24.

² Real image and infrared lens have a different angle of view due to the spacial separation. The image areas therefore do not correspond completely (parallax error).

³ Laser and lens have a different angle of view due to the spacial separation. The laser sighting and the centre of the image thus do not correspond completely (parallax error).

6 Using the product

6.1. Menu functions

6.1.1. Measuring functions

1-point measurement

The **1-point measurement** is the standard measuring function. If this is activated () , all available options can be selected via the quick select buttons.

> [OK] | Measurement | [OK] | 1-point measurement | [OK].

If the **1-point measurement** is activated, the crosshairs can be moved using the **Joystick** on frozen and saved images to read off the individual temperatures.

With saved images, the **1-point measurement** must be activated via the menu for the respective opened picture.

2-point measurement

The **2-point measurement** has 2 crosshairs with which individual temperatures can be read off. If this function is activated () , the quick select buttons are fixed with the functions **Temperature 1** and **Temperature 2**.

With frozen images, only the activated crosshairs can be moved.

With saved images, the **2-point measurement** must be activated for the respective opened picture.

1. [OK] | Measurement | [OK] | 2-point measurement | [OK].
2. Select left or right **Temperature 1** or **Temperature 2** quick select button to activate one of the two crosshairs.
 - The activated crosshairs are shown red.
3. Use the **Joystick** to move the activated crosshairs in order to read off the individual temperatures.

Cold-/Hotspot

Cold-/Hotspot shows the minimum and maximum temperature point on the display. If **Cold-/Hotspot** is activated () , the quick select buttons with the **Coldspot** and **Hotspot** functions can be permanently assigned and can no longer be changed.

With frozen images, the crosshairs can be moved and the min./max. point is visible. The min./max. point is not saved.

With saved images, **Cold-/Hotspot** must be activated for the respective opened image.

- > **[OK] | Measurement | Cold-/Hotspot | [OK].**
- > Select left or right **Coldspot** or **Hotspot** quick select button to activate/deactivate the respective function.

Min./Max. on area

Min./Max. on area shows the minimum and maximum temperature value within the area selection shown on the display. The area selection is neither scalable nor adjustable. If **Min./Max. on area** is activated () , the quick select buttons with the **Scale...** and **Emissivity...** functions can be permanently assigned and can no longer be changed.

With frozen images, the crosshairs can be moved. The Min./Max. on area values are saved together with every image.

With saved images, **Min./Max on area** must be activated for the respective opened image.

- > **[OK] | Measurement | Min./Max. on area | [OK].**

Isotherm





Isotherm shows temperatures in a selectable temperature range in a uniform colour. If **Isotherm** is activated () , the quick select buttons with the **Isotherm** and **Emissivity...** functions can be permanently assigned and can no longer be changed.

With frozen images, the crosshairs can be moved.

- > **[OK] | Measurement | Isotherm | [OK].**

To set the isotherm colour and range:

1. **[Isotherm]**
 - The **Isotherm** dialogue is opened.

2. Move **Joystick** left/right to select the desired option: Isotherm colour () , lower limit value () , temperature range () or upper limit value ().
 - The selected option has an orange border ().
3. Move **Joystick** up/down to change the colour or the value(s).
 - Changes are applied immediately so that the effects on the display of the infrared image can be checked directly.
4. Close dialogue with **[OK]** or **[Esc]**.
 - The changes are saved.

Moisture (from firmware 1.10)

The ambient temperature and humidity values entered manually or measured by the (optional) radio humidity probe are used to calculate the relative surface moisture for each pixel. The values are shown as a humidity image. The special colour palette indicates which areas are at risk of mould:

Colour	Surface moisture	Assessment
green	0...64%RH	non-critical
yellow/orange	65...80%RH	potentially critical
red	>80%RH	critical

If this function is enabled (), the shortcut buttons are permanently assigned the functions **Humidity** (only if no radio humidity probe is logged on) and **Emission level....**

The values for relative humidity and ambient temperature are shown at the top of the display.

1. **[OK] | Measurement | [OK] | Humidity | [OK]**.
 - If a radio humidity probe is logged on: No further information is required.
 - If no radio humidity probe is logged on: The **Humidity** dialogue box is opened. The values for the ambient temperature and humidity can be entered.
2. Move **Joystick** up/down to select the desired option.
 - The selected option has an orange border.
3. Confirm the selection with **[OK]**.
 - The selected number is highlighted orange.

4. Move **Joystick** up/down to set the desired value. Move **Joystick** right/left to change between the numbers.
5. Confirm the entry with **[OK]**.
6. Confirm the settings with **Apply**.

Solar (from firmware 1.10)

To detect and document failures in photovoltaic systems, the solar function can be selected. The sun's radiation intensity measured (with an external instrument) can be entered for documentation purposes. This value is saved with the IR- image.

If this function is enabled () , the shortcut buttons are permanently assigned the functions **Intensity** and **Hotspot**.

The radiation intensity value is shown at the top of the display.

1. **[OK] | Measurement functions | [OK] | Solar | [OK]**.
 - The **Solar** dialogue box is opened. The radiation intensity value can be entered.
2. Confirm selection with **[OK]**.
 - The selected number is highlighted orange.
3. Move **Joystick** up/down to set the required value. Move **Joystick** right/left to switch between the numbers.
4. Confirm entry with **[OK]**.
5. Confirm settings with **[Apply]**.

Measuring range

The measuring range can be set to adapt to the respective area of application.

1. **[OK] | Measurement | [OK] | Measurement range**.
2. Select the desired temperature range and confirm with **[OK]**.



For measuring range **350 - 550 °C (662 - 1022 °F)**:

- The high-temperature filter must be installed, see Optics... page 34.
- With temperature differences larger than 350 K the use of the **Ironbow HT** palette is recommended as it enables lower temperatures to be shown with higher contrast, see Palette page 33.

6.1.2. Image gallery

Show images...

1. **[OK]** | **Image gallery** | **[OK]** | **Show images...** | **[OK]**.
 - The **Folder** dialogue is opened.
 - The folder name of the opened folder is displayed in the header. **ROOT** designates the base folder (top level).
 - The saved data is shown as preview images (image overview). The image saved last is shown directly behind the folders.

Optional:

- > Press the right **[Page scroll]** quick select button to change to page scroll.

In page scroll, you can navigate in groups of 3 x 3 images/folders (page by page). To select/open an image/folder, you must change back into **Single Image**.
2. Navigate:
 - In page scroll: Move **Joystick** up/down to change between the pages.
 - In single image: Move **Joystick** up/down/left/right to select a preview image/a folder (orange border).
 - Open selected folder with **[OK]**.
3. In single image: Press **[OK]** to open selected preview image. Press **Gallery** to return to the image overview.

Delete image

1. In single image: Select image (orange border) or select and open image.
2. Press **Delete** to delete the selected or open image.
 - A confirmation request appears as to whether the image should really be deleted.
3. Confirm with **[OK]** or cancel process with **[Esc]**.

Create new folder

1. In the **Folder** dialogue: Select **New Folder** with the joystick and confirm with **[OK]**.
 - The **Folder name** dialogue is opened.
2. Name folders: Use the **Joystick** to select the desired letters and confirm with **[OK]**.

The folder name can consist of up to 8 characters.
Incorrect entries can be deleted using the right [**◀C**] quick select button.

3. Press left [**Create Folder**] quick select button to create the folder.





Erase all

1. [**OK**] | **Image gallery** | [**OK**] | **Erase all...** | [**OK**].
 - A confirmation request appears as to whether all files on the memory card should be deleted. Folders are not deleted.
2. Confirm erase with [**OK**] or cancel process with [**Esc**].

6.1.3. Scale...

Set scale limits

You can choose between auto-scaling (continuous, automatic adjustment to the current min./max. values) and manual scaling. The scale limits can be set within the activated measuring range (see Measuring range, page 27. All temperatures that undershoot or exceed the limit value are shown in the colour of the limit value (depending on the selected colour palette, see Palette, page 33). Temperature ranges that are not relevant can thus be hidden.

1. [**OK**] | **Scale...** | [**OK**].
 - The **Set scale** dialogue is opened.
2. Move **Joystick** left/right to select the desired option: Auto-scaling () , min. value () , temperature range () or max. value ()
 - The selected option has an orange border () .
3. With the selection of min. value, temperature range or max. value: Move **Joystick** up/down to change the value(s).
 - Changes are applied immediately so that the effects on the display of the infrared image can be checked directly.
4. Close dialogue with [**OK**] or [**Esc**].
 - The changes are saved.

6.1.4. Display...

Select display options

The presentation can be adapted by means of showing/hiding the following elements: Crosshairs, temperature scale and quick select buttons.

Hidden function keys can be shown again by pressing a quick select button: The first press of the button shows the function keys again. To trigger a function, the button must be pressed again.

1. **[OK] | Display... | [OK]**.
 - The **Display options** dialogue is opened.
2. Move **Joystick** up/down to select the desired option.
 - The selected option has an orange border (□).
3. Activate () or deactivate () option with **[OK]**.
4. Confirm settings with the **[Apply]** quick select button.
or
Discard settings with **[Esc]**.

6.1.5. Emissivity...

Emissivity

The emissivity describes the capability of a body to emit electromagnetic radiation. This is material-specific and must be adapted for correct measurement results.

Non-metals (paper, ceramic, gypsum, wood, paints and coatings), plastics and food have high emissivity, which means that the surface temperature can be easily measured using infrared.

Because of their low or non-uniform emissivity, bright metals and metal oxides are only somewhat suited for infrared measurement. You must anticipate highly inaccurate measurements. A remedy for this is coatings that increase the emissivity, e.g. paint or emission adhesive (art. no. 0554 0051) which must be applied to the object being measured.

The following table gives typical emissivities of important materials. These values can be used as orientation with the user-defined settings.

Material (material temperature)	Emissivity
Aluminium, bright rolled (170 °C)	0.04
Cotton (20 °C)	0.77
Concrete (25 °C)	0.93
Ice, smooth (0 °C)	0.97
Iron, emery ground (20 °C)	0.24
Iron with casting skin (100 °C)	0.80
Iron with rolling skin (20 °C)	0.77
Gypsum (20 °C)	0.90
Glass (90 °C)	0.94
Rubber, hard (23 °C)	0.94
Rubber, soft grey (23 °C)	0.89
Wood (70 °C)	0.94
Cork (20°C)	0.70
Radiator, black anodised (50 °C)	0.98
Copper, slightly tarnished (20 °C)	0.04
Copper, oxidized (130°C)	0.76
Plastics: PE, PP, PVC (20 °C)	0.94
Brass, oxidized (200°C)	0.61
Paper (20 °C)	0.97
Porcelain (20 °C)	0.92
Black paint, matt (80 °C)	0.97
Steel, heat-treated surface (200 °C)	0.52
Steel, oxidized (200°C)	0.79
Clay, burnt (70 °C)	0.91
Transformer paint (70 °C)	0.94
Brick, mortar, plaster (20 °C)	0.93

Reflected temperature

Using this offset factor, the reflection is calculated out due to the low emissivity and the accuracy of the temperature measurement with infrared instruments is improved. In most cases, the reflected temperature is identical to the ambient air temperature. Only when objects with strong emissions with much higher temperatures (such as ovens or machines) are in the proximity of the object being measured should the radiation temperature of these heat sources be determined and used (e.g. using a globe thermometer). The reflected temperature has only little effect on objects with high emissivity.

Set emissivity/reflected temperature



You can choose between a user-defined emissivity and 8 materials with recorded emissivities.

The reflected temperature can be set individually.



The designation of the materials in the selection list is configured during commissioning of the thermal imager in the language selected by the user. A translation does not occur in the event of subsequent changeover of the language in the instrument.

Using the PC software, other materials can be imported into the instrument from an existing list. The language for the materials here depends on the operating system language of the PC.

-
1. **[OK]** | **Emissivity...** | **[OK]**.
 - The **Emissivity** dialogue is opened.
 2. Move **Joystick** up/down to select the desired material.
 - The selected material is highlighted orange (). The corresponding emissivity is shown to the right next to the material.
 3. Move **Joystick** to the right to switch to the setting of the emissivity (only available when selecting **User defined**) or to **Reflected temp..**
 - The selected option has an orange border ().
 4. Confirm the selection with **[OK]**.
 - The selected number is highlighted orange ().
 5. Move **Joystick** up/down to set the desired value. Move **Joystick** right/left to change between the numbers.
 6. Confirm the entry with **[OK]**.

7. Confirm the settings with **Apply**.
 - The changes are saved.
 - The selected emissivity (ε) is shown at the bottom right in the display in measurement view.

6.1.6. Palette

Change colour palette for the infrared image

You can choose between 9 existing palettes. The **Ironbow HT** palette is intended specifically for measurements in the high-temperature measuring range (low temperatures are shown with higher contrast). The currently activated option is marked with a tick (✓).

1. **[OK] | Palette | [OK]**.
2. Move **Joystick** up/down to select the desired option.
3. Confirm the selection with **[OK]**.

6.1.7. Configuration



Time/date...

Time and date can be set. Time and date format are automatically set based on the selected instrument language.

1. **[OK] | Configuration... | [OK] | Time/date... | [OK]**.
 - The **Set time/date** dialogue is opened.
2. Move **Joystick** up/down to select the desired option.
 - The selected option has an orange border (□).
3. Confirm the selection with **[OK]**.
 - The selected number is highlighted orange (□).
4. Move **Joystick** up/down to set the value. Move **Joystick** right/left to change between the numbers.
5. Confirm the entry with **[OK]**.
6. Confirm the settings with **Apply**.

Country settings...

Instrument language and temperature unit can be set.

1. **[OK] | Configuration... | [OK].| Country settings... | [OK].**
 - The **Country settings** dialogue is opened.
2. Move **Joystick** up/down to select the desired option.
 - The selected option has an orange border (.
3. Confirm the selection with **[OK].**
 - The selected setting is highlighted orange (.
4. Move **Joystick** up/down to change the setting.
5. Confirm the entry with **[OK].**
6. Confirm the settings with **Apply.**

Optics...

The lenses adjusted to the instrument are shown. Only the lenses that are shown may be used.

The high-temperature filter registered in the instrument is shown. With use of another high-temperature filter, the specified accuracy is not ensured.

> **[OK] | Configuration... | [OK] | Optics... | [OK].**

Using the **Protection glass** option, you can set whether an infrared protection glass is used or not. Ensure the correct setting to prevent corruption of the measurement results.

- > Press **[OK]** to activate () or deactivate () the **Protection glass** option.
 - With the option activated, the protection glass symbol () is shown in the bottom right of the display.

SuperResolution (optional)

SuperResolution is a technology to improve image quality. Each time an image is recorded, a sequence of images is saved on the thermal imager and used to calculate a higher-resolution image with the aid of the PC software (no interpolation). The pixel count increases by a factor of 4, while the geometric resolution (IFOV) is improved by a factor of 1.6.

To use the function, the imager must be hand-held (no tripod).

i This function is available as an additional option (article no. 0554 7806) and must be activated before it can be used, if the option was not ordered at the same time as the imager.

Activate function (only with subsequent order):



You will receive an envelope with an access code (**identification code**), which you should enter on the

When all necessary data has been entered, an **activation code** is generated and can be used to activate the function via the IRSofT PC software. Please observe the installation requirements and steps on the website or in the email sent to you.



Activate/deactivate function:

> **[OK] | Configuration... | [OK] | SuperResolution | [OK]**.

When you save an image, an information window with the image file name is displayed. If SuperResolution is activated () , **SuperResolution** is also displayed after the file name.

Power-save options...

Options can be set to extend the rechargeable battery running time.

1. **[OK] | Configuration... | [OK] | Power-save options... | [OK]**.
 - The **Power-save options** dialogue is opened.
2. Move **Joystick** up/down to select the desired option.
 - The selected option has an orange border (.
3. Confirm the selection with **[OK]**.
 - **LCD backlight**: The selected setting is highlighted orange and can be changed (.
 - > Move **Joystick** up/down to change the setting. Confirm the entry with **[OK]**.
 - **Switch off LCD** or **Power off imager**: The selected option can be activated or deactivated.
 - > Press **[OK]** to activate () or deactivate () the function.
 - With the option activated, the length of time until shut-down can be set.
 - > Move **Joystick** to the right and press **[OK]**. Move **Joystick** up/down to change the setting. Confirm the entry with **[OK]**.
4. Confirm the settings with **[Apply]**.

Radio...

A radio humidity probe can be logged onto the instrument.

The function **Radio...** can only be selected if a radio module is connected (accessory), see **Insert radio module (accessories)** Page 18.

Every radio probe has a probe identification number (RFID). This is made up of the three-digit RFID number on the probe and the position of the switch in the battery compartment of the radio probe (H or L). To be logged on at the instrument, the radio probe must be switched on and the transfer rate must be set to 0.5 sec. This occurs by briefly pressing the on/off button when switching on (also see instructions for use of radio probe)

1. **[OK] | Configuration... | [OK] | Radio... | [OK]**.
 - The **Radio...** dialogue box is opened.
 - The probe-IDs of the radio probes found are displayed.

If no radio probe was found, this may be because of the following:

- The radio probe is not switched on or the battery of the radio probe is spent.

- The radio probe is outside the range of the instrument.
 - Sources of interference are influencing radio transmission (e.g. reinforced concrete, metal objects, walls or other barriers between transmitter and receiver, other transmitters of the same frequency, strong electromagnetic fields).
 - > If necessary: Rectify the possible causes of the fault in radio transmission.
2. Press **[OK]** to enable () or disable () the radio connection.
 3. Move **Joystick** right to switch to a list of the radio probes found.
 4. Move **Joystick** up/down to select a probe.
 - The selected probe is highlighted orange ()
 5. Confirm selection with **Apply**.

-
- i** If no readings appear during the measurement:
- > Check the potential causes, see above.
-

Audio settings...

The volume of the audio playback and recording can be set.

1. **[OK] | Configuration... | [OK] | Audio settings... | [OK]**.
 - The **Audio settings...** dialogue is opened.
2. Move **Joystick** up/down to select the desired option.
 - The selected option has an orange border ()
3. Move **Joystick** left/right to change the setting.
4. Confirm the settings with **[Apply]**.

Format...

The memory card can be formatted. During the formatting, all saved data on the SD card is lost.

1. **[OK] | Configuration... | [OK] | Format... | [OK]**.
 - A confirmation request appears as to whether the memory card should really be formatted.
2. Confirm with **[OK]** or cancel process with **[Esc]**.

Factory reset

The instrument settings can be reset to the factory settings. Time/date and country settings are not reset.

Please note: After a factory reset, the numbering of images begins anew. When saving images, images that have already been saved and have the same number are overwritten!

- > Transfer all saved images onto a PC before performing a reset to prevent possible overwriting.
- 1. **[OK] | Configuration... | [OK] | Factory settings... | [OK]**.
- A confirmation request appears as to whether the instrument should really be reset to the factory settings.
- 2. Confirm reset with **[OK]** or cancel process with **[Esc]**.

6.2. Measuring

CAUTION

Damage to the infrared detector by measuring high scene temperatures.

- > Without high-temperature filter: do not direct the thermal imager at areas > 500°C / 932 °F.
- > With high-temperature filter: do not direct the thermal imager at areas > 800°C / 1472°F.

i When measuring temperatures > 350°C or > 662°F, always install the high-temperature filter, see **Mounting/removing high-temperature filter** page 20, and adjust the high-temperature measurement range, see **Measuring** range Seite 27.

i With the high-temperature measuring range (**350.0 - 550.0 °C** or **662.0 - 1022 °F**) activated, the stated accuracy specifications are not valid for readings below 350 °C or 662 °F as this range is not calibrated.

Important framework conditions

Please observe the following framework conditions in order to obtain significant measurement results.

Humidity measurement:

- Pivot radio humidity probe or separate humidity measuring instrument slightly to shorten the adjustment time: Avoid sources of interference (e.g. breathed air).

Building thermography, investigating the building shell:

- Considerable temperature difference between inside and outside required (ideal: > 15 °C/> 27 °F).
- Consistent weather conditions, no intensive sunlight, no precipitation, no strong wind.

To ensure the highest level of accuracy, the imager requires an equalization period of 5 minutes after being switched on.

Important settings

Before recording an image, check whether the protection glass option is set correctly to prevent corruption of the measurement results, Optics... page 34.

Before saving an image, ensure that it is focused correctly (in focus), see Focus image using motor focus page 21 or Manually focusing the image page 21. Images that are not in focus cannot be corrected retroactively!

To obtain precise readings, the emissivity and reflected temperature must be set correctly, see Set emissivity/reflected temperature page 32. A subsequent adjustment is possible via the PC software as required.

With an activated auto scaling, the colour scale is continuously adapted to the min./max. values of the current measurement image. The colour that is to be assigned to a specific temperature thereby changes constantly. To be able to compare multiple images by means of the colouring, the scaling must be manually set to fixed values, see Scale... page 29, or must be subsequently adjusted to uniform values using the PC software.

i Depending on the scene temperature, the measuring range may be undershot or exceeded. In this case, --- or +++ is shown instead of the readings.

- > If this occurs, change the measuring range, see Measuring range page 27.

Select the storage location (folder):

1. While an image is frozen (fixed image): Press the left **[Folder]** quick select button.

- The **Folder** dialogue is opened.

To create a new folder, see Create new folder page 28.











2. Select the desired folder with the joystick and open with **[OK]**.

- The folder name of the opened folder is displayed in the header.

3. Press left **[Apply]** quick select button to select the opened folder.

Recording/playing audio comments

It is only possible to record an audio comment for frozen images. It is possible to play audio comments with frozen and saved pictures.

1. While an image is frozen (fixed image): Press the right **[Audio]** quick select button.
 - The Audio dialogue is opened.
2. Select the desired function with the joystick and confirm with **[OK]**.
 - Record audio comments:
 1. Start recording: Press [].
 2. Stop recording: Press [].
 - > Continue recording: Press [] again.
 - Play recording:
 1. Select beginning of recording: Press [] again.
 2. Start playback: Press [].
 3. Stop playback: Press [].
 - > Continue playback: Press [] again.
 - Change audio comment:
 1. Selection position from which the recording should be overwritten: Begin playback with [] and stop at the desired point [].
 2. Use [] to overwrite the recording as of the desired point.
 - Delete recording:
 - > Press [].
 - The complete recording is deleted.
 - Exit Audio dialogue:
 - > Press **[ESC]**.

Aiming at the measuring surface

Using the laser, the measuring surface can be aimed at.

 **WARNING**

Eye damage due to laser beam!

- > Do not look into the laser beam.
- > Do not point the laser beam at people.

To change the quick select button functions, Changing assignment of the quick select buttons page 22.

- > Press and hold **[Laser]**.
- When the laser is active, the laser symbol () flashes.



Caution: Laser and lens have a different angle of view due to the spacial separation. The laser sighting and the centre of the image thus do not correspond completely (parallax error). The laser dot is therefore not suitable for marking locations that were aimed at using the crosshairs.

7 Maintaining the product

Changing the battery

To prevent losing the instrument settings: Only change the rechargeable battery when a buffer battery is inserted in the instrument or the mains unit is connected.

1. Press lock release button.
 - The rechargeable battery is released and sticks out a little from the rechargeable battery slot. The locking function keeps the battery from falling out.
2. Completely remove the battery from the rechargeable battery slot.
3. Insert a new battery into the rechargeable battery slot until this is flush with the bottom of the handle.
 - The thermal imager starts automatically.

Clean thermal imager

- > If the housing of the thermal imager is dirty, clean it with a damp cloth. Do not use any aggressive cleaning agents or solvents! Weak household cleaning agents and soap suds may be used.

Cleaning lens/ protection glass/high-temperature filter

- > Large dust particles can be removed with a clean optical cleaning brush (available in specialized photography shops).
- > Use a lens cleaning cloth for slight contamination. Do not use rubbing alcohol!

Change buffer battery

To prevent losing the instrument settings: Only change the buffer battery when a charged rechargeable battery is inserted or the mains unit is connected.

1. Open the cover on the left side of the thermal imager.
2. Remove battery holder, including buffer battery, from the battery slot.
3. Remove empty battery from the holder and insert new battery (type CR 1632).

NOTICE

Incorrectly inserted batteries can lead to damage of the product!

- > When inserting the batteries, observe the polarity (label on the battery holder).

4. Insert battery holder into the battery slot.

8 Tips and assistance

8.1. Questions and answers

Question	Possible causes/solution
Message Backup battery empty or not present is shown.	<ol style="list-style-type: none"> 1. Confirm the message with [OK]. 2. Change buffer battery, see Change buffer battery page 43.
Error No memory card inserted! is shown.	<p>Memory card defective or not inserted.</p> <ol style="list-style-type: none"> 1. Confirm the message with [OK]. 2. Check or insert memory card.
Error Memory card full! is shown.	<p>Insufficient memory present.</p> <ol style="list-style-type: none"> 1. Confirm the message with [OK]. 2. Insert new memory card.
Error No lens/wrong lens! is shown.	<ol style="list-style-type: none"> 1. Switch off thermal imager. 2. Check lens.
Message Charging not possible! is shown.	<p>Ambient temperature is outside the permissible range for charging the battery.</p> <ol style="list-style-type: none"> 1. Confirm the message with [OK]. 2. Keep to the permissible ambient temperature.
Error Permissible instrument temperature exceeded! is shown.	<ol style="list-style-type: none"> 1. Switch off thermal imager. 2. Let instrument cool off and keep to the permissible ambient temperature.
--- or +++ is shown instead of the reading.	<p>Reading is outside of the measuring range.</p> <p>> Change measuring range.</p>
xxx is shown instead of the reading.	<p>Reading cannot be calculated.</p> <p>> Check parameter settings for plausibility.</p>

Question	Possible causes/solution
Measurement function Humidity : No readings from the radio probe are shown.	Radio probe not logged on or sources of interference in the radio transmission: > Check possible causes, see Radio... , page 36.

8.2. Accessories and spare parts

Description	Article no.
Lens protection glass	0554 8805
High-temperature filter (Retrofitting)	on request
Rech. batt.	0554 8802
Desktop charging station	0554 8801
Tripod	0554 8804
Mains unit	0554 8808
SD card	0554 8803
USB cable	0449 0047
ISO calibration certificate for thermal imager:	
• Calibration points 0 °C, 25 °C, 50 °C in measuring range -20 °C - 100 °C	0520 0489
• Calibration points at 0 °C, 100 °C, 200 °C in measuring range 0 °C to 350 °C	0520 0490

For further accessories and spare parts, please refer to the product catalogues and brochures or look up our website: