



Fyrite®

iNSIGHT® PLUS

Combustion Gas Analyzer

Instruction Manual

Configuration • Operation • Maintenance



P/N: 0024-9487

Revision 2

August 2014

Product Leadership • Training • Service • Reliability

WARRANTY

Bacharach, Inc. warrants to Buyer that at the time of delivery this product will be free from defects in material and manufacture and will conform substantially to Bacharach Inc.'s applicable specifications. Bacharach's liability and buyer's remedy under this warranty are limited to the repair or replacement, at Bacharach's option, of this product or parts thereof returned to seller at the factory of manufacture and shown to Bacharach Inc.'s reasonable satisfaction to have been defective; provided that written notice of the defect shall have been given by buyer to Bacharach Inc. within two (2) years after the date of delivery on Product, CO sensor, and O₂ sensor, and within three (3) years after the date of delivery of the LL O₂ sensor.

Bacharach, Inc. warrants to buyer that it will convey good title to this product. Bacharach's liability and buyer's remedy under this warranty of title are limited to the removal of any title defects or, at the election of Bacharach, to the replacement of this product or parts thereof that are defective in title.

THE FOREGOING WARRANTIES ARE EXCLUSIVE AND ARE GIVEN AND ACCEPTED IN LIEU OF (I) ANY AND ALL OTHER WARRANTIES, EXPRESS OR IMPLIED, INCLUDING WITHOUT LIMITATION THE IMPLIED WARRANTIES OF MERCHANTABILITY AND FITNESS FOR A PARTICULAR PURPOSE: AND (II) ANY OBLIGATION, LIABILITY, RIGHT, CLAIM OR REMEDY IN CONTRACT OR TORT, WHETHER OR NOT ARISING FROM BACHARACH'S NEGLIGENCE, ACTUAL OR IMPLIED. The remedies of the buyer shall be limited to those provided herein to the exclusion of any and all other remedies including, without limitation incidental or consequential damages. No agreement varying or extending the foregoing warranties, remedies or this limitation will be binding upon Bacharach, Inc. unless in writing, signed by a duly authorized officer of Bacharach.

Fyrite[®] INSIGHT[®] Plus Manual

NOTICE

Product improvements and enhancements are on-going, therefore the specifications and information contained in this document may change without notice.

Bacharach, Inc. shall not be liable for errors contained herein or for incidental or consequential damages in connection with the furnishing, performance, or use of this material.

No part of this document may be photocopied, reproduced, or translated to another language without the prior written consent of Bacharach, Inc.

Copyright © 2014, Bacharach, Inc., all rights reserved.

BACHARACH, Fyrite, INSIGHT, and B-SMART are registered trademarks of Bacharach, Inc. All other trademarks, trade names, service marks and logos referenced herein belong to their respective companies.

Table of Contents

SECTION 1. OVERVIEW	1
1.1. Introduction	1
1.2. Conventions	1
1.3. Safety	1
1.4. Product Overview	3
1.5. North American (NA) vs. Siegert (S) Combustion Equations.....	3
1.6. Components.....	5
1.7. Features	7
1.8. Combustion Test Process Overview.....	9
1.9. Fyrite [®] INSIGHT [®] Plus Sales Combinations	10
1.10. Specifications	11
SECTION 2. SETUP	15
2.1. Connecting the Probe and Thermocouple	15
2.2. Front Panel Buttons	16
2.3. Power Options	18
2.4. Turning the Fyrite [®] INSIGHT [®] Plus On/Off.....	19
SECTION 3. CONFIGURATION	21
3.1. Menu Structure Overview.....	21
3.2. The Warm-up Sequence	21
3.3. Main Menu.....	22
3.4. Select Fuel Menu	24
3.5. Pressure Menu	26
3.6. Temperature Menu.....	26
3.7. Tune-Rite Option (North American Only)	27
3.8. Leak Test Menu (Siegert Only).....	27
3.9. Ambient CO Menu (Siegert Only)	29
3.10. Memory Options Menu	30
3.11. Setup Menu.....	32
3.12. Calibration Menu	55
3.13. Diagnostics Menu.....	56
3.14. Status Menu	59
SECTION 4. OPERATION	61
4.1. Prerequisites	61

Fyrite[®] INSIGHT[®] Plus Manual

4.2. Sampling Point Examples	61
4.3. Combustion Testing Process	64
4.4. The RUN Screen	66
4.5. Making a Draft or Pressure Measurement	68
4.6. Printing Using the Optional IrDA Printer.....	69
4.7. Graphics Screens	72
4.7.1. Overview	72
4.7.2. Graphical Line Graph Trend Screen	73
4.7.3. Bar Graph Screen	74
4.7.4. Stack Temperature Hot Spot Screen.....	77
4.8. Taking Ambient CO Measurements (Siegert Only)	77
4.9. PC Interface and Fyrite [®] User Software.....	78
SECTION 5. CALIBRATION AND MAINTENANCE	79
5.1. Serviceability	79
5.2. Cleaning the Probe.....	79
5.2.1. Equipment Required	80
5.2.2. Procedure	80
5.3. Water Trap and Filter Replacement.....	81
5.4. O ₂ and/or CO Sensor Replacement.....	82
5.4.1. Accessing the Sensors	82
5.4.2. Material Required (As Needed)	82
5.4.3. O ₂ Sensor Replacement Procedure.....	82
5.4.4. CO Sensor Replacement Procedure.....	83
5.4.5. B-SMART [®] CO Sensor Replacement.....	85
5.5. Pressure Sensor Calibration	86
5.5.1. Materials Required	86
5.5.2. Procedure	86
5.6. T-Stack Calibration	88
5.6.1. Materials Required	88
5.6.2. T-Stack Calibration Procedure	88
5.7. T-Air Calibration	90
5.7.1. Materials Required	90
5.7.2. T-Air Calibration Procedure	91
5.8. CO Sensor Calibration	93
5.8.1. Materials Required	93
5.8.2. CO Manual Zero Procedure	93
5.8.3. CO Sensor Span Procedure	94
5.9. T-Ref Sensor Calibration	95
SECTION 6. TROUBLESHOOTING	96

Fyrite[®] INSIGHT[®] Plus Manual

6.1. Error and Warning Messages	96
6.2. Replacement Parts	98
6.3. Accessories.....	99
6.4. Instrument Identification	100
6.5. Service Centers	100
CE Declaration of Conformity	101
Index	103



Section 1. Overview

1.1. Introduction

Thank you for investing in a Bacharach Fyrite® INSIGHT® Plus combustion analyzer. To assure proper use and operator safety, please read the contents of this manual for important information on the operation and maintenance of the analyzer.

1.2. Conventions



WARNING: A warning statement denotes a potential hazard associated with the use of this equipment. Failure to follow this information could result in serious personal injury or death.



CAUTION: A caution statement indicates a potentially hazardous situation which, if not avoided, may result in minor or moderate injury. Caution statements may also be used to alert against unsafe practices.



IMPORTANT: An important statement provides emphasis of an important feature, operation, etc. Failure to follow this information could void your warranty, result in improper operation, or cause equipment damage.



NOTE: A note statement provides emphasis of a feature, operation, practice, etc.

1.3. Safety



WARNING: This analyzer is not intended to be used as a safety device.



WARNING: When testing an appliance, a full visual inspection of the appliance should be performed to ensure its safe operation.



CAUTION: This analyzer is not intended to be used on a continuous basis.



CAUTION: Do not store instrument or its sensors with solvents or products that contain solvents.



CAUTION: Except for sensor and battery replacement, this analyzer should only be opened and/or serviced by authorized Bacharach personnel. Failure to comply may void the warranty.



HAZARDOUS AREA WARNING: This instrument has not been designed to be intrinsically safe for use in areas classified as hazardous locations. For your safety, **DO NOT** use it in hazardous (classified) locations.



CAUTION: Do not use flammable or combustible substances (like carburetor fluid used for cleaning the probe) near an open flame.



CAUTION: When the instrument is used in an inefficient oil-fueled appliance where there is a high emission of soot, the probe's sample filter may become clogged. Before every use confirm that the filter is clean and replace it with a new filter if necessary.

To prevent soot intake and a clogged filter, a smoke test should be performed before operating under such conditions. This ensures that the furnace or boiler is burning at a level appropriate for the use of this instrument.

When the CO₂ level exceeds the allowable threshold, a warning will prompt the user to consider performing a smoke test. This screen is cleared by pressing the ENTER button. Once the warning is cleared, it will not be displayed again for that particular test. If a new test is started (by pressing the HOLD button), the warning will be displayed again if the limit has been exceeded.



IMPORTANT: Never disconnect the probe from the instrument until purging is complete. Otherwise, leftover target gas (for example, CO) may remain in the probe and cause inaccurate zeroing at power up that could lead to inaccurate gas measurements afterwards.

1.4. Product Overview

The Fyrite[®] INSIGHT[®] Plus is a portable hand-held combustion analyzer for use in residential and light commercial applications. It is intended to be used by:

- HVAC contractors
- home inspectors
- maintenance personnel
- energy auditors

to conduct combustion efficiency analysis on residential and light commercial furnaces and appliances in the worldwide market.

The instrument is supplied with all of the following components:

- probe and hose assembly
- four disposable “AA” alkaline batteries
- hard carrying case
- rubber boot
- spare filters
- factory-calibrated and installed sensors as ordered

and, depending on the model and kit, some or all of the following:

- Fyrite[®] User Software (FUS)
- USB cable (type A to Mini B)
- Infrared Data Association (IrDA) printer with four disposable “AA” alkaline batteries
- printer paper.

1.5. North American (NA) vs. Siegert (S) Combustion Equations

Though the combustion *process* is fairly standardized across the globe, a combustion analyzer intended for worldwide use demands a degree of flexibility for a few regional preferences. The Fyrite[®] INSIGHT[®] Plus provides a North American (NA) configuration and a Siegert (S) configuration (see page 52) to address these and other needs, which are contrasted below.



NOTE: Detailed differences between North American and Siegert configurations are noted where appropriate in this manual.

Feature	North American (NA) versus Siegert (S) Configurations	
Countries	Typical North American (NA) Users Asia Australia Latin America North America South America	Typical Siegert (S) Users Belgium Denmark France Germany Italy Netherlands Poland Spain United Kingdom
Heating Values	For combustion calculations, Siegert uses the fuel's <i>lower</i> heating value; NA uses the <i>higher</i> value (see page 66).	
Fuels	Different fuel sets and composition (see page 24)	
Different RUN Parameters	EFF (NA) vs. Stack loss and ETA (S) Excess Air (NA) vs. Lambda (S) (Lambda is similar to excess air) (see page 66)	
Extra Siegert Parameters	CO/CO ₂ ratio, boiler temperature, smoke number, and oil derivative are displayed for Siegert only (see page 66).	
CO ₂ Max	In the Siegert configuration, the user can set a CO ₂ Max number for the fuel (see page 24).	
Print Average Feature	There is a print average feature for Siegert (see page 32).	
Time and Date Format	NA: MM/DD/YY w/ 12-hour time format with AM/PM or DD/MM/YY w/ 24-hour time format (see page 49) Siegert: DD/MM/YY w/ 24-hr time format only	
Languages	3 for the North American (NA) configuration and 8 for the Siegert (S) configuration (See language list on page 46)	



NOTE: The Combustion Equations setting is used to configure the instrument to use either North American combustion equations or Siegert combustion equations (see page 52). Changing *this* setting resets memory and the values of *other* settings. Refer to page 52 for a list of affected parameters.

1.6. Components

- | | |
|---|--|
| <ol style="list-style-type: none"> 1 Graphic Color Display 2 Function Keys (F1, F2, and F3) <ul style="list-style-type: none"> • Context sensitive • Functions shown at bottom of display 3, 4 Up and Down Arrow Keys <ul style="list-style-type: none"> • Scroll up/down through a list • Increase/decrease alphanumeric values 5, 6 Left and Right Arrow Keys <ul style="list-style-type: none"> • Scroll left/right through a field • Jump to top/bottom of list 7 Enter Key <ul style="list-style-type: none"> • Choose highlighted item • Accept value/characters 8 Escape Key <ul style="list-style-type: none"> • Cancel most operations and display previous screen 9 Power Key <ul style="list-style-type: none"> • Press & release Power ON • Press & hold (2 secs) Begin power OFF sequence 10 Run/Hold Key <ul style="list-style-type: none"> • While in HOLD Turns on pump, displays RUN screen, and begins combustion test. • While in RUN Turns off pump, displays HOLD screen and last set of combustion data. • In most menus Displays HOLD screen. • During power down Returns display to HOLD screen (cancels power down). | |
|---|--|

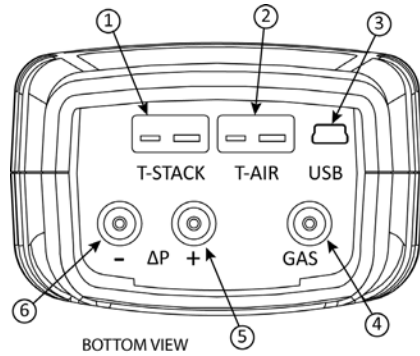

- 1 Stack Temperature Connector (T-STACK)
- 2 Primary Ambient Air Connector (T-AIR)
- 3 USB Connector (Mini B)
- 4 Sample Gas Connector
- 5 Draft Connector (+ ΔP)
- 6 Differential Pressure Connector (- ΔP)

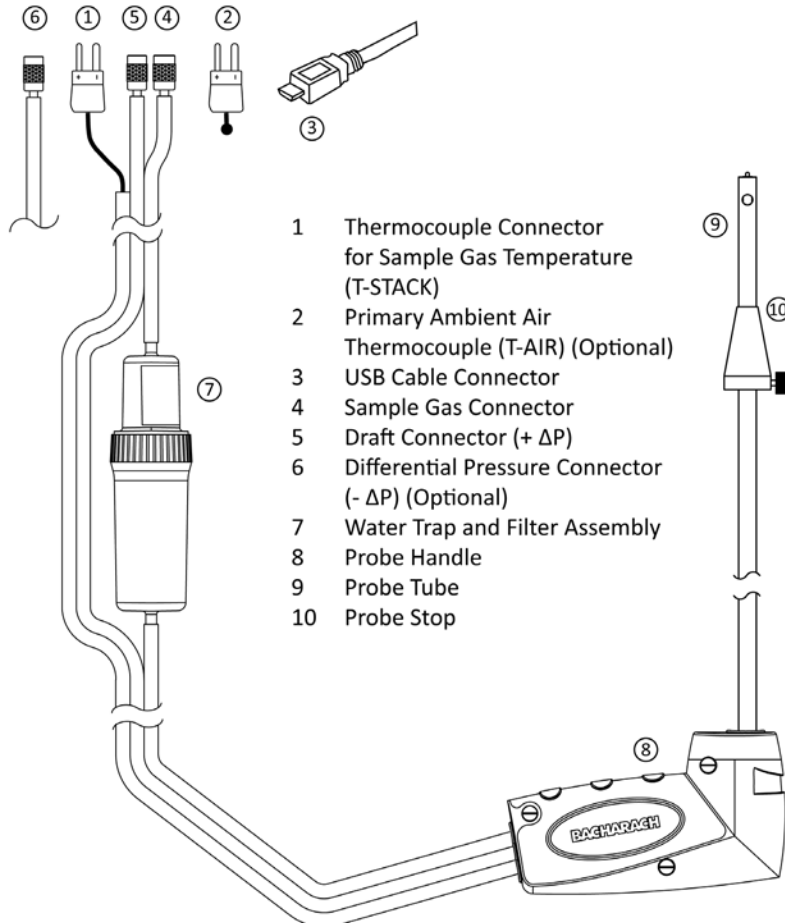

- 1 Thermocouple Connector for Sample Gas Temperature (T-STACK)
- 2 Primary Ambient Air Thermocouple (T-AIR) (Optional)
- 3 USB Cable Connector
- 4 Sample Gas Connector
- 5 Draft Connector (+ ΔP)
- 6 Differential Pressure Connector (- ΔP) (Optional)
- 7 Water Trap and Filter Assembly
- 8 Probe Handle
- 9 Probe Tube
- 10 Probe Stop

1.7. Features

- Sensors
 - Field-replaceable electrochemical sensors (O₂ and B-SMART® CO) (pp 82-84)
 - Optional long life O₂ sensor (pp 10, 82)
 - Pressure sensor (pp 6, 26)
 - Flue gas (and optionally T-AIR) temperature measurement using a Type K thermocouple (p 6)
- Fuel codes
 - Nine available fuels (in North American configuration) (p 24)
 - Ten available fuels (in Siegert configuration) (p 24)
 - Custom fuel code entry (p 25)
- Power
 - USB cable (PC or wall adapter) (p 12)
 - 4 AA alkaline batteries (included) (p 12)
 - 4 AA lithium batteries (p 12)
 - 4 AA rechargeable batteries (externally charged) (p 12)
 - Low battery warning (pp 12, 96)
- Testing Features
 - Complete test results (100 sets) can be stored, recalled, displayed, downloaded, and printed (pp 10, 30, 66)
 - Secure calibration function (password protected) (p 55)
 - Auto power-off feature with sensor purge feature (p 48)
 - Graphic screens showing trending, bar, and hotspot graphic functions (p 72)
 - Status and diagnostic menus (pp 56, 59)
 - Manual entry of values (Siegert only) (pp 24, 34, and 35)
 - Calibration reminder function (p 47)
 - Custom display formats (pp 43, 49, 69, and 71)
 - Zoom feature (p 38)
 - Print range feature (p 31)
 - Ambient CO (Siegert Only) (pp 29, 77)
- User Customizations
 - North American and Siegert combustion calculations (pp 52, 66)
 - Multi-language interface (46)
 - Auto/Manual zero functions for the CO sensor (pp 21, 50, 93)
 - Customized logo on printouts (192 x 384 pixels) (p 71)
 - Customized user information (3 lines of 20 characters) (pp 43, 69)
 - Ten sets of test IDs to customize printouts (p 39)

- Temperature and pressure unit selection (p 32)
- Hardware
 - Probe/hose assembly for gas transport and temperature input (p 6)
 - Sample pump to provide gas sample delivery
 - Backlit color graphic LCD (p 5)
 - Hard carrying case (see below)
 - Time and date stamping of 100 test results
 - USB 2.0 (mini-B connection) for PC interface and communications (p 5)
- PC Interface (p 78)
 - USB cable (Type A to Mini B)
 - Fyrite® User Software (FUS) (Windows compatible)
 - Updates, instrument configuration, and downloading test results



1.8. Combustion Test Process Overview

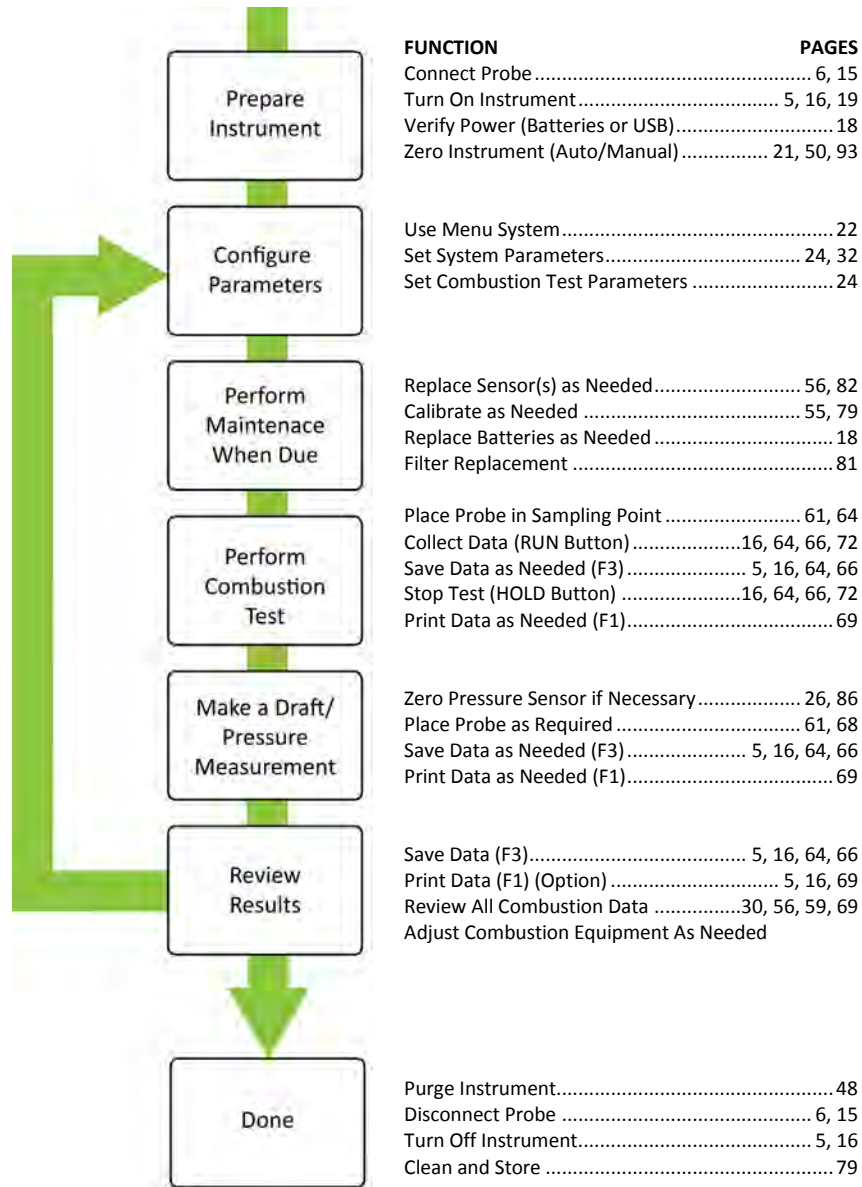

1.9. Fyrite® INSIGHT® Plus Sales Combinations

Fuel Equations	North American				Siegert			
Final Assembly	0024-7343		0024-7344		0024-7345		0024-7346	
O ₂ Sensor Type	Standard		Long Life		Standard		Long Life	
Kit Type: B=Basic R=Reporting	B	R	B	R	B	R	B	R
Sales Kit P/N	0024-8515	0024-8516	0024-8517	0024-8518	0024-8519	0024-8520	0024-8521	0024-8522
Hard Case	✓	✓	✓	✓	✓	✓	✓	✓
Sampling Probe & Hose	✓	✓	✓	✓	✓	✓	✓	✓
Manual	✓	✓	✓	✓	✓	✓	✓	✓
Batteries	✓	✓	✓	✓	✓	✓	✓	✓
Boot	✓	✓	✓	✓	✓	✓	✓	✓
Spare filters	✓	✓	✓	✓	✓	✓	✓	✓
CO Sensor w/NO _x Filter	✓	✓	✓	✓	✓	✓	✓	✓
Pressure	✓	✓	✓	✓	✓	✓	✓	✓
T-Air	✓	✓	✓	✓	✓	✓	✓	✓
T-Stack	✓	✓	✓	✓	✓	✓	✓	✓
O ₂ Sensor	✓	✓			✓	✓		
LL O ₂ Sensor			✓	✓			✓	✓
Fuels	9	9	9	9	10	10	10	10
Memory	100	100	100	100	100	100	100	100
Fyrite® User Software (FUS)		✓		✓		✓		✓
USB Cable		✓		✓		✓		✓
Printer		✓		✓		✓		✓

1.10. Specifications

Specification	Description
Temperature	Storage: -20° to 50° C (-4° to 122° F) 0° to 20° C (32° to 68° F) optimal Operation: -5° to 45° C (23° to 113° F) Reference: 20° ± 2° C (68° ± 4° F)
Humidity	Storage: 15 to 90% RH, non-condensing Operation: 15 to 95% RH, non-condensing Reference: 45 ± 10% RH, non-condensing
Pressure	1 atmosphere ± 10%
Weight	16 ounces (454 g) with batteries
Dimensions (HxWxD)	8.0" x 3.6" x 2.3" (20.3 cm x 9.1 cm x 5.8 cm)
Warm-up Time	Minimum = 30 seconds; Maximum = 60 seconds
Gas Sample Flow Rate	300 to 700 cc/min
Sensors	O ₂ Electrochemical (P/N: 0024-0788) CO w/ NOx Filter Electrochemical (P/N: 0024-1593) LL O ₂ (Optional) Electrochemical (P/N: 0024-1591) Temp (Stack) K-Type thermocouple Temp (Air) K-Type thermocouple Pressure Piezo-resistive
Product Approvals and Regulatory Compliance	EN50270: (CE Mark) EMC tested in accordance with European Directive 2004/108/EC. EN50379: Standard for portable electrical apparatus designed to measure combustion flue gas parameters of heating appliances (Siegert only) Parts 1 and 3. ROHS Compliance
Case Construction	High impact ABS plastic with rubber over mold Protective rubber boot with molded-in magnets.
Display	Color 2.8" graphics LCD
USB Connector	Mini B (USB 2.0)

Overview

Fyrite® INSIGHT® Plus Manual

Specification	Description	
IrDA Port	Protocol: IrDA-SIR Baud Rate: 9600 Parity: None	Data Bits: 8 Stop Bits: 1
Memory	100 locations for storing test results	
Power Supply Options	Batteries (4 AA)	Type: Disposable Alkaline (Included) Duration: 15 hours min, continuous max draw
		Type: Disposable Lithium Duration: 20 hours, continuous max draw
		Type: Rechargeable Duration: 8 hours, continuous max draw
	USB Cable (A to Mini B)	Source: PC Source: AC source (via Wall Adapter)

Measurement	Range	Resolution	Accuracy	Response Time (T ₉₀)
O ₂ and LL O ₂	0 to 20.9 %	0.1% O ₂	± 0.3% O ₂	< 20 sec
CO w/ NO _x filter	0 to 4000 ppm	1 ppm	± 10 ppm (0 to 200 ppm) ± 5% (201 to 4000 ppm)	< 40 sec
Ambient Temp	-20° to 316° C (-4° to 600° F)	0.1° C (0.1° F)	± 1° C (0 to 100° C)	< 70 sec
Stack Temp	-20° to 650° C (-4° to 1202° F)	1° C (1° F)	± 2° C (0° to 124° C) ± 3° C (125° to 249° C) ± 4° C (250° to 400° C)	< 50 sec
Differential Temp	± 600° C (± 1112° F)	0.1° C (0.1° F)	N/A	N/A
Pressure / Differential Pressure	± 100 mB (± 40 inwc)	0.01 mB (0.01 inwc)	± 0.03 mB (-1 to 1 mB) ± 3% (-40 to -1 mB) ± 3% (1 to 40 mB)	N/A



NOTE: The North American (NA) configuration of the Fyrite[®] INSIGHT[®] Plus computes and displays the calculations as long as the measured oxygen is not above 16% O₂ and the stack temperature is not above 650° C (1202° F). The Siegert configuration of the Fyrite[®] INSIGHT[®] Plus computes and displays the calculations as long as the measured oxygen is not above 18.8% O₂ and the stack temperature is not above 650° C (1202° F).

Calculation	Calculation Range	Resolution	Configuration	
			NA	Siegert
Efficiency (HHV)	0.1 to 100 %	0.1%	X	X
ETA (LHV)	0 to 115%	0.1%		X
Excess Air	1 to 250 %	1%	X	
Stack Loss	0.1 to 100 %	0.1 %		X
Lambda	1 to 9.55	0.01		X
CO ₂ (dry basis)	0.1 to a fuel-dependent max in %	0.1 %	X	X
CO Ref to O ₂	0 to 9999 ppm	1 ppm	X	X
CO/CO ₂ Ratio	0.0001 to fuel-dependent max	0.0001		X



Section 2. Setup

2.1. Connecting the Probe and Thermocouple

A rigid stainless steel probe with handle is connected to a flexible hose with an integral water-trap / filter used to draw a gas sample into the analyzer from the room, grills, diffusers, and furnace flues. Refer to page 6.

1. Inspect the sample gas hose for cracks. If a hose is defective, replace the entire probe assembly.
2. Before using the analyzer, check that the water trap/filter is clean and dry. If necessary, dry out the trap and replace the filter element (see page 81).
3. Push the probe's sample gas hose onto the GAS inlet connector.
4. Push the probe's draft hose (+ ΔP) onto the "+" pressure connector.
5. Push the probe's thermocouple into the T-STACK connector on the instrument, noting its orientation.







IMPORTANT: The T-STACK connector tabs are keyed to fit into the connector in only one orientation. DO NOT force the thermocouple connector tabs into the T-STACK connector.

6. Push the optional ambient/primary-air thermocouple into the T-AIR connector.



NOTE: Refer to page 6 for locations and details of components.

2.2. Front Panel Buttons

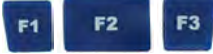
Button	Description
	<ul style="list-style-type: none"> • Powers the analyzer ON and OFF. Hold this button down for at least 2 seconds to turn the power OFF.
	<ul style="list-style-type: none"> • UP (▲), DOWN (▼), LEFT (◀), and RIGHT (▶) arrows are context-specific navigation buttons for the menus. • UP (▲) and DOWN (▼) arrow buttons scroll to menu options that are hidden from view (when a side scroll bar is displayed indicating additional information). • UP (▲) and DOWN (▼) arrow buttons cause the displayed value to increase or decrease accordingly. • LEFT (◀) and RIGHT (▶) arrow buttons jump to the top and bottom of lists, respectively. • LEFT (◀) and RIGHT (▶) arrow buttons scroll through additional graphics screens. • LEFT (◀) and RIGHT (▶) arrow buttons position the active cursor on specific elements of a value to be changed.
	<ul style="list-style-type: none"> • The ENTER button. Performs the action selected.
	<ul style="list-style-type: none"> • While in the HOLD screen, turns the sample pump on, displays the RUN screen, and begins a combustion test. • While in the RUN screen, turns the sample pump off, displays the HOLD screen and the last set of combustion data. • Displays the HOLD screen while pressing it from most menus. • Return the display to the HOLD screen while pressing it during the shutdown sequence.
	<ul style="list-style-type: none"> • The ESC button cancels most operations and displays the previous screen.
	<ul style="list-style-type: none"> • Pressing function keys accepts the corresponding function defined above that key at the bottom of the display (for example, PRINT, SAVE, MENU, etc.).

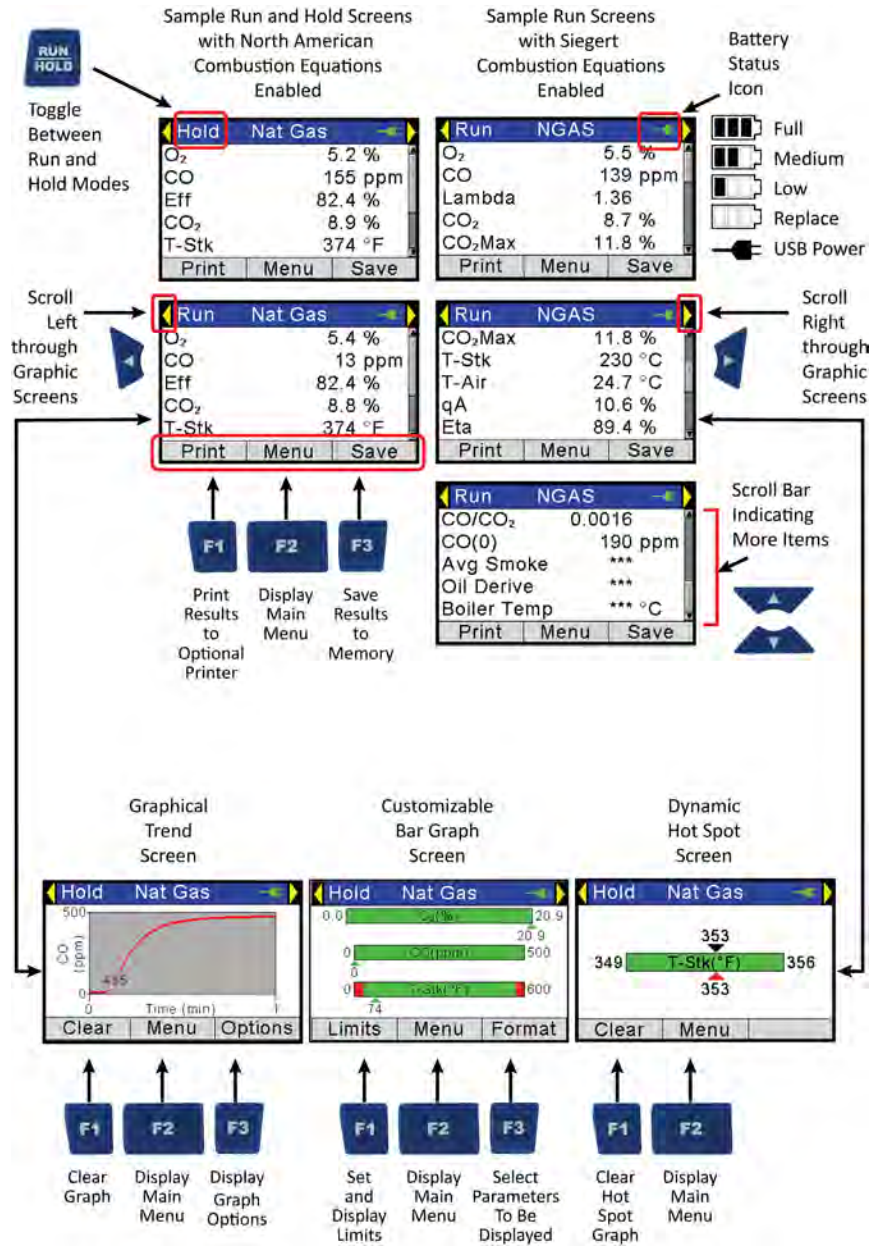





2.3. Power Options

Power options include:

- Disposable AA alkaline batteries (included)
- Disposable AA lithium (Li) batteries
- Externally charged rechargeable NiMH batteries
- Power via USB cable (PC or wall adapter).

Check the Fyrite® INSIGHT® Plus for sufficient power prior to each use. Replace the batteries if the low (or replace) battery symbol appears in the upper right corner of the Fyrite® INSIGHT® Plus screen.

	Full	The battery symbol changes colors from green to red as battery voltage decreases. In addition, the red Replace Battery symbol flashes.
	Medium	
	Low	
	Replace	The optional USB cable can be used to power the instrument in place of batteries. The USB Power symbol is displayed when the cable is connected between a Fyrite® INSIGHT® Plus and a computer or wall adapter.
	USB Power	

Batteries (4 AA, Fresh or Fully Charged)	Estimated Life Span in Hours (Continuous, Pump On)
Alkaline (disposable)	15 hours
Lithium (disposable)	20 hours
Rechargeable	8 hours

Replace batteries as follows.

1. Remove the battery cover from the back of analyzer.
2. If old batteries are installed, remove them and properly discard them.
3. Observing the polarity markings inside the battery compartment, install four 'AA' disposable (alkaline or lithium) batteries or four fully-charged (externally charged) AA rechargeable NiMH batteries.
4. Replace the battery cover.



NOTE: The Fyrite[®] INSIGHT[®] Plus does NOT charge rechargeable batteries.

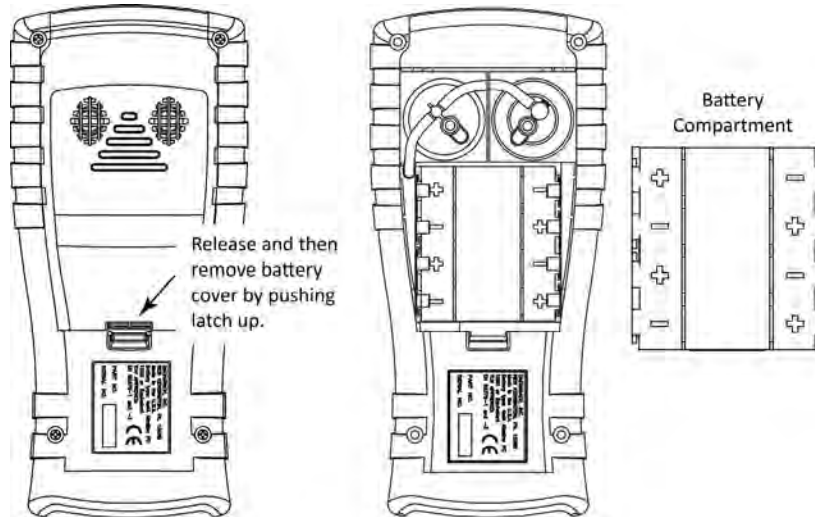

NOTE: A Set Clock error message will be displayed if the instrument is without power for an extended period of time.

2.4. Turning the Fyrite[®] INSIGHT[®] Plus On/Off



To turn on the Fyrite[®] INSIGHT[®] Plus, press the POWER button. Press and hold the power again button to begin the shutdown cycle.



NOTE: After turning on the Fyrite[®] INSIGHT[®] Plus, it performs a warm-up procedure which includes an auto-zero procedure for the sensors. For this reason, be sure to turn on the Fyrite[®] INSIGHT[®] Plus in a clean air environment.



Section 3. Configuration



3.1. Menu Structure Overview



NOTE: The Fyrite® INSIGHT® Plus may be configured to use either North American combustion equations or Siegert combustion equations. As a result, several parameters are unique to each configuration. This section shows a mix of screens that have been configured for North American combustion equations as well as Siegert combustion equations. Depending on how you have configured your instrument, your screens may vary slightly from those pictured in this section.

Menus and the items contained within them are described in a top-down fashion, starting from the warm-up screens and working sequentially through the menus and menu items.

3.2. The Warm-up Sequence

Warm-up Screens	Description
 <p>Version: 1.00 Model: 24-7343 Serial: SS1019</p>	<p>Splash screen shows the Bacharach logo with version, model number, and serial number information. This screen is displayed for approximately 3 seconds.</p> <p>A warm-up screen is displayed during which the instrument is purged and initialized. A countdown timer is displayed with the current zero setting for the CO sensor (Auto-Zero or Manual Zero).</p>
 <p>Warm Up: 55 CO-Auto-Zero</p>	<p>If any errors are detected during warmup, the corresponding error messages are displayed, after which the user presses F2 to go to the Menu, or presses RUN/HOLD to go to the Hold screen.</p> <p>Sample errors (T-STACK and Set Clock errors) are shown below.</p> 

3.3. Main Menu

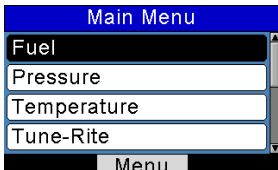
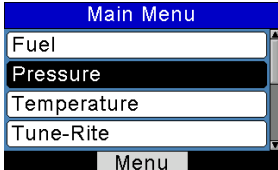
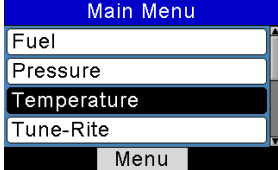
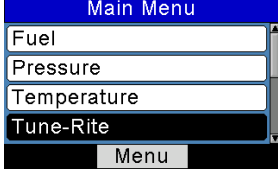
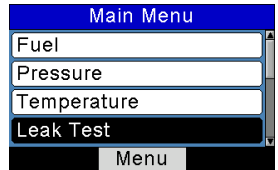
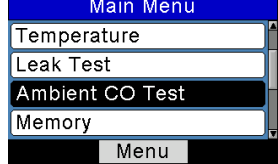
Main Menu	Function
 <p>Main Menu Fuel Pressure Temperature Tune-Rite Menu</p>	<p>Access the Select Fuel Menu (see page 24).</p> <ul style="list-style-type: none"> Select combustion fuel
 <p>Main Menu Fuel Pressure Temperature Tune-Rite Menu</p>	<p>Access the Pressure Menu (see page 26).</p> <ul style="list-style-type: none"> View current pressure readings Gas pressure, Differential across heat exchanger, draft reading, and differential pressure Corresponding zero, save, and print functions
 <p>Main Menu Fuel Pressure Temperature Tune-Rite Menu</p>	<p>Access the Temperature Menu (see page 26).</p> <ul style="list-style-type: none"> View current temperature readings Differential across heat exchanger and differential temperature Corresponding zero, save, and print functions
 <p>Main Menu Fuel Pressure Temperature Tune-Rite Menu</p>	<p>Access the Tune-Rite option (see page 27). Available on North American units only.</p> <ul style="list-style-type: none"> Get guidance based on live data and typical characteristics of the combustion equipment Print a detailed, customizable, and value-added service report
 <p>Main Menu Fuel Pressure Temperature Leak Test Menu</p>	<p>Access the Leak Test Menu (Siegert only) (see page 27).</p> <ul style="list-style-type: none"> Let-by and Tightness functions
 <p>Main Menu Temperature Leak Test Ambient CO Test Memory Menu</p>	<p>Access the Ambient CO Test Menu (Siegert only) (see page 29).</p>

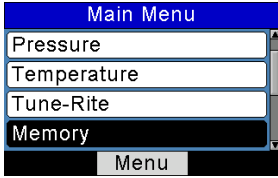
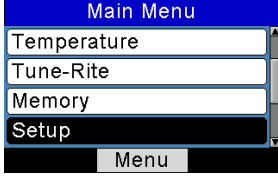
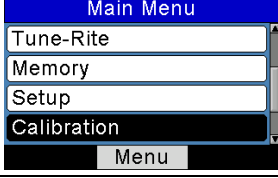
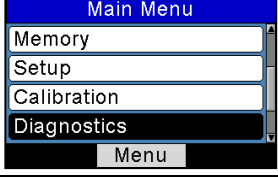
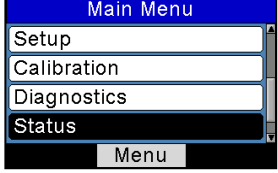
Main Menu	Function
 <p>Main Menu</p> <p>Pressure</p> <p>Temperature</p> <p>Tune-Rite</p> <p>Memory</p> <p>Menu</p>	<p>Access the Memory Options Menu (see page 30).</p> <ul style="list-style-type: none"> • Access previously saved test results • Delete all previously saved test results
 <p>Main Menu</p> <p>Temperature</p> <p>Tune-Rite</p> <p>Memory</p> <p>Setup</p> <p>Menu</p>	<p>Access the Setup Menu (see page 32).</p> <ul style="list-style-type: none"> • Edit/view instrument preferences • Edit/view system parameters • Edit/view combustion test parameters
 <p>Main Menu</p> <p>Tune-Rite</p> <p>Memory</p> <p>Setup</p> <p>Calibration</p> <p>Menu</p>	<p>Access the Calibration Password Screen and the Calibration Menu (see page 55).</p> <ul style="list-style-type: none"> • Calibrate sensors
 <p>Main Menu</p> <p>Memory</p> <p>Setup</p> <p>Calibration</p> <p>Diagnostics</p> <p>Menu</p>	<p>Access the Diagnostics Menu (see page 56).</p> <ul style="list-style-type: none"> • View “run” meters • View system diagnostic values • Check O₂ sensor life • Fresh air diagnostics
 <p>Main Menu</p> <p>Setup</p> <p>Calibration</p> <p>Diagnostics</p> <p>Status</p> <p>Menu</p>	<p>Access the Device Status Menu (see page 59).</p> <ul style="list-style-type: none"> • Access model number, serial number, and firmware version information

3.4. Select Fuel Menu

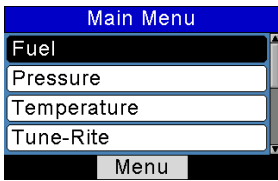
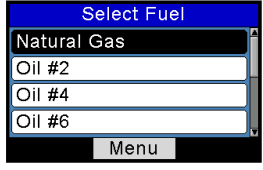
Select Fuel	Function																										
	<p>Fuel List</p> <p>Select the combustion fuel from the fuel list. Use the UP (▲) and DOWN (▼) arrow buttons to highlight the desired fuel and use the ENTER button to select.</p> <table border="1"> <thead> <tr> <th>NA Fuel List</th> <th>Siegert Fuel List</th> </tr> </thead> <tbody> <tr> <td>Natural Gas</td> <td>Natural Gas</td> </tr> <tr> <td>Oil 2</td> <td>KOKS</td> </tr> <tr> <td>Oil 4</td> <td>LEG</td> </tr> <tr> <td>Oil 6</td> <td>Propane</td> </tr> <tr> <td>Propane</td> <td>Oil 2</td> </tr> <tr> <td>Coal</td> <td>Oil 6</td> </tr> <tr> <td>Wood</td> <td>Coal</td> </tr> <tr> <td>Kerosene</td> <td>Biofuel</td> </tr> <tr> <td>B5 (Biodiesel 5%)</td> <td>LPG</td> </tr> <tr> <td>Custom #1*</td> <td>Butane</td> </tr> <tr> <td>Custom #2*</td> <td>Custom #1*</td> </tr> <tr> <td></td> <td>Custom #2*</td> </tr> </tbody> </table> <p><i>* See below for information on custom fuels.</i></p> 	NA Fuel List	Siegert Fuel List	Natural Gas	Natural Gas	Oil 2	KOKS	Oil 4	LEG	Oil 6	Propane	Propane	Oil 2	Coal	Oil 6	Wood	Coal	Kerosene	Biofuel	B5 (Biodiesel 5%)	LPG	Custom #1*	Butane	Custom #2*	Custom #1*		Custom #2*
NA Fuel List	Siegert Fuel List																										
Natural Gas	Natural Gas																										
Oil 2	KOKS																										
Oil 4	LEG																										
Oil 6	Propane																										
Propane	Oil 2																										
Coal	Oil 6																										
Wood	Coal																										
Kerosene	Biofuel																										
B5 (Biodiesel 5%)	LPG																										
Custom #1*	Butane																										
Custom #2*	Custom #1*																										
	Custom #2*																										
	<p>CO₂ Max Value (Siegert Only)</p> <p>In Siegert configurations, additional screens are added after the fuel is selected. These screens permit the adjustment of the CO₂ max value. Use the DOWN (▼) arrow key to highlight “Adjust” and use the ENTER button to select. Use the arrow buttons to select and adjust the desired value of CO₂ Max.</p>																										

Select Fuel	Function
	<div style="display: flex; justify-content: space-around;"> <div style="border: 1px solid black; padding: 5px; width: 45%;"> <p style="text-align: center; background-color: #000080; color: white; margin: 0;">CO₂Max</p> <p style="background-color: #000080; color: white; margin: 0;">Default (11.8)</p> <p style="background-color: #000080; color: white; margin: 0;">Adjust</p> <p style="text-align: center; background-color: #cccccc; margin: 0;">Menu</p> </div> <div style="border: 1px solid black; padding: 5px; width: 45%;"> <p style="text-align: center; background-color: #000080; color: white; margin: 0;">Adjust CO₂MAX</p> <p style="margin: 0;">CO₂Max: 11.8</p> <p style="margin: 0;">Press ENTER to Save</p> <p style="text-align: center; background-color: #cccccc; margin: 0;">Menu</p> </div> </div> <p>Siegert configurations accept manually adjusted CO₂ max values which are used for combustion calculations and represent corrections for fuel variations. Adjusted CO₂ max values are stored with saved combustion records and displayed in the RUN/HOLD screen. CO₂ max values are entered through software menu selections when a fuel type is selected.</p> <p>Custom Fuel Codes</p> <p>In addition to the fuel codes built-in to the Fyrite® INSIGHT® Plus, the instrument supports 2 additional fuels from which you may choose. If your combustion application requires a fuel type not listed in the Fuel Type menu,</p> <p>Custom fuel codes are developed by Bacharach at a customer's request and can be loaded into the instrument using the Fyrite® User Software (FUS). If one or more fuel codes are downloaded to the instrument, they will appear at the bottom of the fuel list in the Fuel Menu.</p> <hr/> <div style="display: flex; align-items: center;">  <p>NOTE: Custom fuel codes are specific to the combustion equations that are being used (see page 52), so be sure to include your combustion equation type (North American or Siegert) with any custom fuel code requests.</p> </div> <hr/>

3.5. Pressure Menu

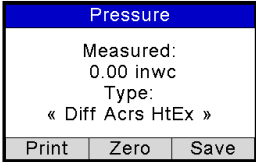
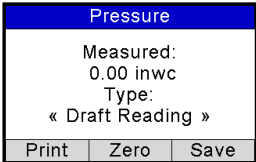
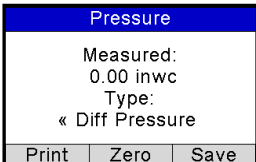
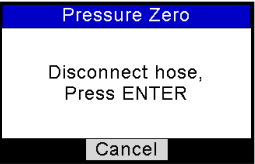
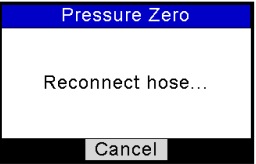
Pressure	Function
 <p>Pressure Measured: 0.00 inwc Type: « Diff Acrs HtEx » Print Zero Save</p>	<p>Displays the current pressure reading. Use F1 to print the current value (see page 69), F2 to zero the reading, and F3 to save the reading to memory.</p> <p>Use the LEFT (◀) and RIGHT (▶) arrow buttons to scroll through the following pressure readings:</p> <ul style="list-style-type: none"> • Diff Acrs HtEx • Draft Reading • Diff Pressure <p>To zero the pressure reading, press F2 and follow the instructions on the display. The draft reading or pressure screen is displayed when zeroing is complete.</p>
 <p>Pressure Measured: 0.00 inwc Type: « Draft Reading » Print Zero Save</p>	
 <p>Pressure Measured: 0.00 inwc Type: « Diff Pressure » Print Zero Save</p>	
	 

3.6. Temperature Menu

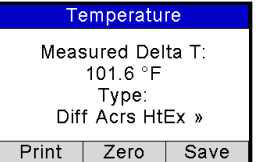
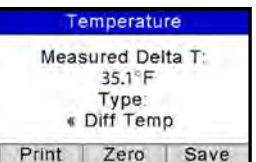
Temperature Menu	Function
 <p>Temperature Measured Delta T: 101.6 °F Type: Diff Acrs HtEx » Print Zero Save</p>	<p>Displays the current temperature reading. Use F1 to print the current value (see page 69), F2 to zero the temperature reading, and F3 to save the reading to memory.</p> <p>Use the LEFT (◀) and RIGHT (▶) arrow buttons to scroll through the following temperature readings:</p> <ul style="list-style-type: none"> • Diff Acrs HtEx • Diff Temp <p>To zero the temperature reading, press F2 and follow the instructions on the display. The Diff Temp screen is displayed when zeroing is complete.</p>
 <p>Temperature Measured Delta T: 35.1 °F Type: « Diff Temp » Print Zero Save</p>	

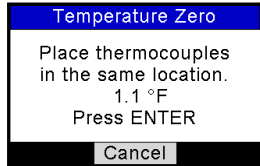
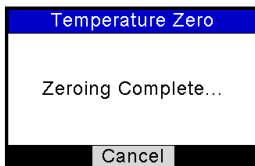
Temperature Menu	Function
	 

3.7. Tune-Rite Option (North American Only)

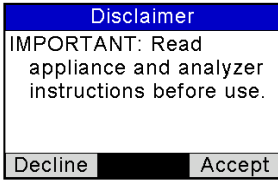
Tune-Rite Option	Function
	<p>Provides access to the Tune-Rite combustion assistant software (North American version only). Refer to the Tune-Rite™ Software Operation manual (P/N 0024-9504) for information.</p>



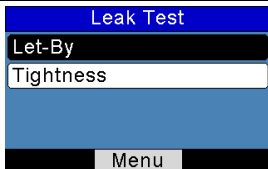
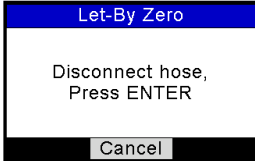
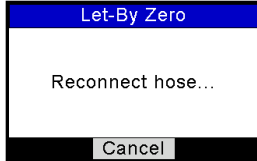

3.8. Leak Test Menu (Siegert Only)

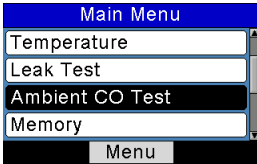

Let-by and Tightness are regional requirements for the UK market with very specific procedures. While they may be useful in other local jurisdictions to provide means to have safe readings for leak checks of gas and safe combustion processes, they are simply one way to test for these problems. Other procedures may be specified by local authorities. Please refer to your local and regional regulations to be sure you are in compliance accordingly.

Leak Test Menu	Function
	<p>To perform the Let-By test, use the UP (▲) and DOWN (▼) arrow buttons to highlight the Let-By option and press ENTER. Follow the instructions on the screen.</p>  

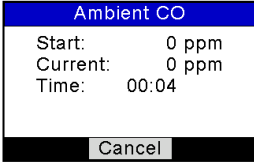
Leak Test Menu	Function							
	<table border="1"> <tr> <td data-bbox="695 478 950 636"> <p>Let-By</p> <p>Start: 10.00 Units: mB</p> <p>Press ENT to start</p> <p>Cancel</p> </td> <td data-bbox="966 478 1221 636"> <p>Let-By Stabilize</p> <p>Start: 10.00 Units: mB</p> <p>Time: 44 s</p> <p>Cancel</p> </td> </tr> <tr> <td data-bbox="695 646 950 804"> <p>Let-By</p> <p>Start: 10.00 Current: 10.00 Change: 0.00 Units: mB Time: 59 s</p> <p>Cancel</p> </td> <td data-bbox="966 646 1221 804"> <p>Let-By Summary</p> <p>Start: 10.00 End: 9.77 Change: -0.23 Units: mB Test Time: 60 s</p> <p>Print Menu Save</p> </td> </tr> </table>	<p>Let-By</p> <p>Start: 10.00 Units: mB</p> <p>Press ENT to start</p> <p>Cancel</p>	<p>Let-By Stabilize</p> <p>Start: 10.00 Units: mB</p> <p>Time: 44 s</p> <p>Cancel</p>	<p>Let-By</p> <p>Start: 10.00 Current: 10.00 Change: 0.00 Units: mB Time: 59 s</p> <p>Cancel</p>	<p>Let-By Summary</p> <p>Start: 10.00 End: 9.77 Change: -0.23 Units: mB Test Time: 60 s</p> <p>Print Menu Save</p>			
<p>Let-By</p> <p>Start: 10.00 Units: mB</p> <p>Press ENT to start</p> <p>Cancel</p>	<p>Let-By Stabilize</p> <p>Start: 10.00 Units: mB</p> <p>Time: 44 s</p> <p>Cancel</p>							
<p>Let-By</p> <p>Start: 10.00 Current: 10.00 Change: 0.00 Units: mB Time: 59 s</p> <p>Cancel</p>	<p>Let-By Summary</p> <p>Start: 10.00 End: 9.77 Change: -0.23 Units: mB Test Time: 60 s</p> <p>Print Menu Save</p>							
<table border="1"> <tr> <td data-bbox="397 825 662 989"> <p>Leak Test</p> <p>Let-By</p> <p>Tightness</p> <p>Menu</p> </td> </tr> </table>	<p>Leak Test</p> <p>Let-By</p> <p>Tightness</p> <p>Menu</p>	<p>To perform the Tightness test, use the UP (▲) and DOWN (▼) arrow buttons to highlight the Tightness option and press ENTER. Follow the instructions on the screen.</p> <table border="1"> <tr> <td data-bbox="695 951 950 1108"> <p>Tightness Zero</p> <p>Disconnect hose, Press ENTER</p> <p>Cancel</p> </td> <td data-bbox="966 951 1221 1108"> <p>Tightness Zero</p> <p>Reconnect hose...</p> <p>Cancel</p> </td> </tr> <tr> <td data-bbox="695 1119 950 1276"> <p>Tightness</p> <p>Start: 20.00 Units: mB</p> <p>Press ENT to start</p> <p>Cancel</p> </td> <td data-bbox="966 1119 1221 1276"> <p>Tightness Stabilize</p> <p>Start: 20.00 Units: mB</p> <p>Time: 10 s</p> <p>Cancel</p> </td> </tr> <tr> <td data-bbox="695 1287 950 1444"> <p>Tightness</p> <p>Start: 19.99 Current: 19.81 Change: -0.18 Units: mB Time: 54 s</p> <p>Cancel</p> </td> <td data-bbox="966 1287 1221 1444"> <p>Tightness Summary</p> <p>Start: 19.99 End: 19.62 Change: -0.38 Units: mB Test Time: 120 s</p> <p>Print Menu Save</p> </td> </tr> </table>	<p>Tightness Zero</p> <p>Disconnect hose, Press ENTER</p> <p>Cancel</p>	<p>Tightness Zero</p> <p>Reconnect hose...</p> <p>Cancel</p>	<p>Tightness</p> <p>Start: 20.00 Units: mB</p> <p>Press ENT to start</p> <p>Cancel</p>	<p>Tightness Stabilize</p> <p>Start: 20.00 Units: mB</p> <p>Time: 10 s</p> <p>Cancel</p>	<p>Tightness</p> <p>Start: 19.99 Current: 19.81 Change: -0.18 Units: mB Time: 54 s</p> <p>Cancel</p>	<p>Tightness Summary</p> <p>Start: 19.99 End: 19.62 Change: -0.38 Units: mB Test Time: 120 s</p> <p>Print Menu Save</p>
<p>Leak Test</p> <p>Let-By</p> <p>Tightness</p> <p>Menu</p>								
<p>Tightness Zero</p> <p>Disconnect hose, Press ENTER</p> <p>Cancel</p>	<p>Tightness Zero</p> <p>Reconnect hose...</p> <p>Cancel</p>							
<p>Tightness</p> <p>Start: 20.00 Units: mB</p> <p>Press ENT to start</p> <p>Cancel</p>	<p>Tightness Stabilize</p> <p>Start: 20.00 Units: mB</p> <p>Time: 10 s</p> <p>Cancel</p>							
<p>Tightness</p> <p>Start: 19.99 Current: 19.81 Change: -0.18 Units: mB Time: 54 s</p> <p>Cancel</p>	<p>Tightness Summary</p> <p>Start: 19.99 End: 19.62 Change: -0.38 Units: mB Test Time: 120 s</p> <p>Print Menu Save</p>							



3.9. Ambient CO Menu (Sievert Only)

Ambient CO	Function
	<p>Access the Ambient CO Menu (Sievert only).</p> <p>When initiated, the Ambient CO feature monitors CO values continuously and captures a reading every minute for 15 minutes (a total of 16 readings from t_0 to t_{15}).</p> <p>Press ENTER to initiate the Ambient CO test. This begins a 15-minute test cycle, during which a status screen is displayed. It shows the starting ambient CO value, the current CO value, and the elapsed time into the test.</p> <div style="display: flex; justify-content: space-around;">   </div> <hr/> <p> NOTE: Press the F2 key to cancel a test in progress.</p> <hr/> <p>After the test is complete, the Ambient CO Summary screen is displayed. This is a scrollable window that shows the 16 CO “snapshot” readings, as well as the maximum CO reading that was sampled during the entire test.</p> <hr/> <p> NOTE: The Max CO Reading is the highest sampled CO reading – even if the reading was taken in between one of the sample “snapshot” readings.</p>

Ambient CO	Function					
	Ambient CO Summary			Ambient CO Summary		
	Time(min)	CO(ppm)		12	0	
	0	0		13	0	
	1	0		14	0	
	2	0		15	0	
	3	0		Max CO	0	
	Print	Menu	Save	Print	Menu	Save
	<p>The test results can be printed by pressing F1 and saved to memory (with a time and date stamp) by pressing F3. Press F2 to return to the menu.</p> <hr/> <p> NOTE: If the ambient CO results are saved to memory, they are not included as part of the Print Average feature.</p> <hr/> <p> NOTE: Any over-range CO values (e.g., CO = 4000 ppm) are displayed as “xxx”.</p> <hr/>					

3.10. Memory Options Menu

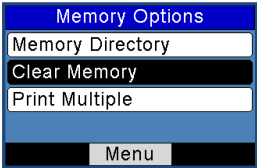
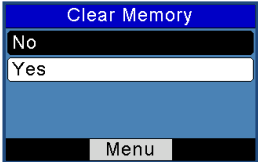
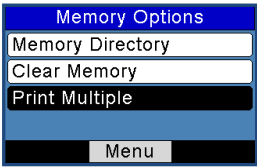
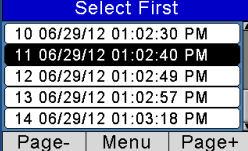
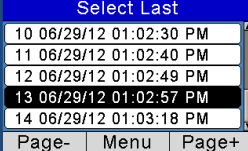
Memory Options	Function												
<table border="1"> <tr><td>Memory Options</td></tr> <tr><td>Memory Directory</td></tr> <tr><td>Clear Memory</td></tr> <tr><td>Print Multiple</td></tr> <tr><td>Menu</td></tr> </table>	Memory Options	Memory Directory	Clear Memory	Print Multiple	Menu	<p>Provides access to the Memory Directory. This directory contains a numbered list of up to 100 saved test records (combustion data, pressure data, temperature data, etc.). “NO DATA” is displayed if no tests were saved since the last time memory was cleared.</p> <div style="text-align: center;"> <table border="1"> <tr><td>Memory Directory</td></tr> <tr><td>9 06/29/12 12:52:03 PM</td></tr> <tr><td>10 06/29/12 01:02:30 PM</td></tr> <tr><td>11 06/29/12 01:02:40 PM</td></tr> <tr><td>12 06/29/12 01:02:49 PM</td></tr> <tr><td>13 06/29/12 01:02:57 PM</td></tr> <tr><td>Page- Menu Page+</td></tr> </table> </div> <p>To view saved data, use the UP (▲) and DOWN (▼) arrow buttons to highlight the desired test from the list. Press the ENTER button to display the saved data.</p>	Memory Directory	9 06/29/12 12:52:03 PM	10 06/29/12 01:02:30 PM	11 06/29/12 01:02:40 PM	12 06/29/12 01:02:49 PM	13 06/29/12 01:02:57 PM	Page- Menu Page+
Memory Options													
Memory Directory													
Clear Memory													
Print Multiple													
Menu													
Memory Directory													
9 06/29/12 12:52:03 PM													
10 06/29/12 01:02:30 PM													
11 06/29/12 01:02:40 PM													
12 06/29/12 01:02:49 PM													
13 06/29/12 01:02:57 PM													
Page- Menu Page+													

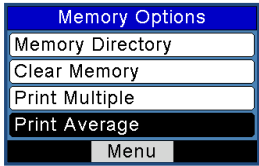
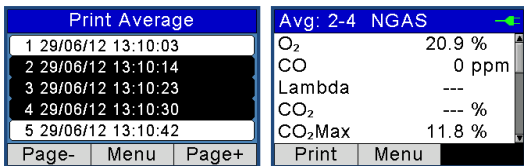
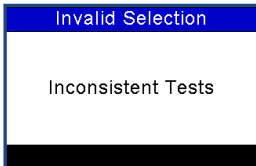

Memory Options	Function
	<p>Allows user to delete contents of memory. A Yes/No confirmation screen is displayed before all saved test records are cleared from memory. Use the DOWN (▼) arrow (to select Yes) and press ENTER to confirm or use the UP (▲) arrow (to select No) and press ENTER to cancel.</p> 
	<p>Allows the user to select a range of test records to be printed. Use the UP (▲) and DOWN (▼) arrows to select the first record and then press ENTER. Use the UP (▲) and DOWN (▼) arrow buttons to select the last record and then press ENTER. Position IrDA printer (see page 69 for printing information). Press ENTER to print.</p> <div style="display: flex; justify-content: space-around;"> <div data-bbox="695 1016 950 1178">  </div> <div data-bbox="959 1016 1214 1178">  </div> </div> <div style="display: flex; justify-content: space-around; margin-top: 10px;"> <div data-bbox="695 1182 950 1344">  </div> <div data-bbox="959 1182 1214 1344">  </div> </div>

Memory Options	Function
	<p>Print Average (Sievert Only) displays the memory directory with the first 3 samples highlighted. Use the UP (▲) and DOWN (▼) arrow buttons to move the scrolling window up and down to select which three contiguous samples are to be averaged, then press ENTER.</p> <p>The average is calculated, displayed, and available for printing.</p>  <p>An error screen is displayed if fewer than 3 samples exist or if the 3 selected samples include non-combustion test data (e.g., saved pressure data).</p> 

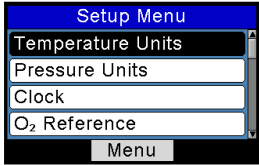
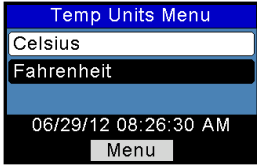

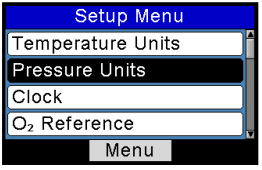
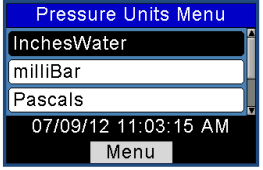
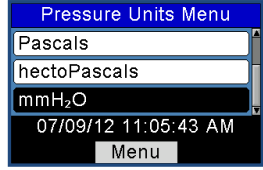

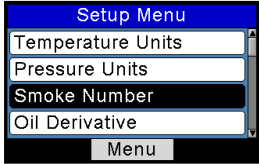
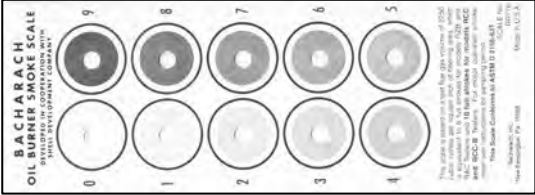
3.11. Setup Menu

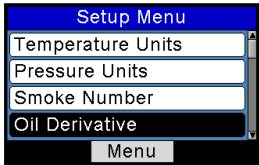
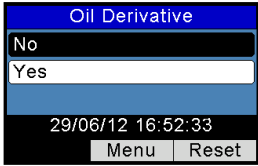
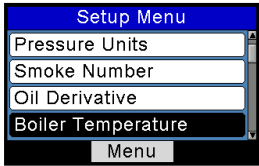
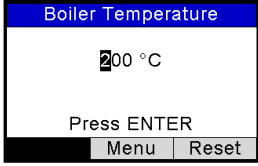

Setup Menu	Function
	<p>Set Temperature Unit (°C or °F) for display and printing purposes.</p> <p>Use the UP (▲) and DOWN (▼) arrow buttons to highlight the desired choice. Press the ENTER button to use the selected temperature unit. Press ESC to quit without saving.</p> 

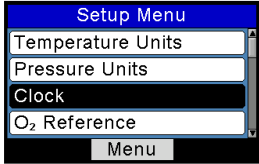

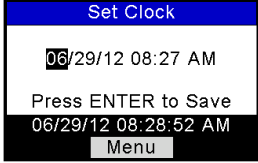
Setup Menu	Function
	<p>Set Pressure Unit for display and printing purposes.</p> <ul style="list-style-type: none"> • inches water column • millibars • Pascals • hecto Pascals • mm H₂O <p>Use the UP (▲) and DOWN (▼) arrow buttons to highlight the desired choice.</p> <p>Press the ENTER button to use the selected pressure unit. Press ESC to quit without saving.</p> <div style="display: flex; justify-content: space-around;"> <div data-bbox="688 709 948 877">  </div> <div data-bbox="948 709 1208 877">  </div> </div>

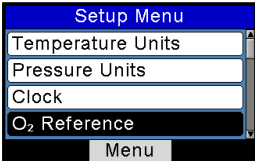
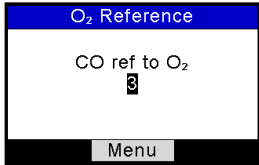

Setup Menu	Function		
	<p>Smoke Number (Sievert only) is used to calculate and display an average smoke value based on 3 smoke test results that are entered by the user. A sample smoke scale is shown below.</p>  <p>Perform 3 smoke tests then enter the results in the 3 smoke number parameters shown below.</p> <p>Use the UP (▲) and DOWN (▼) arrow buttons to highlight smoke number 1, 2, or 3, then press ENTER.</p> <p>Use the LEFT (◀) and RIGHT (▶) arrow buttons to set the smoke number (0-9) that most closely matches the numerical value on your smoke scale for that sample. Press ENTER when finished. The average smoke number is displayed, and will be included on printouts.</p> <table border="1" data-bbox="690 1058 1208 1220"> <tr> <td data-bbox="690 1058 943 1220"> <p>Smoke Number</p> <p>Smoke No. 1: 1 Smoke No. 2: 2 Smoke No. 3: 8</p> <p>Press ENTER</p> <p>Menu Reset</p> </td> <td data-bbox="943 1058 1208 1220"> <p>Smoke Number</p> <p>Average Smoke No.: 2</p> <p>Menu</p> </td> </tr> </table>	<p>Smoke Number</p> <p>Smoke No. 1: 1 Smoke No. 2: 2 Smoke No. 3: 8</p> <p>Press ENTER</p> <p>Menu Reset</p>	<p>Smoke Number</p> <p>Average Smoke No.: 2</p> <p>Menu</p>
<p>Smoke Number</p> <p>Smoke No. 1: 1 Smoke No. 2: 2 Smoke No. 3: 8</p> <p>Press ENTER</p> <p>Menu Reset</p>	<p>Smoke Number</p> <p>Average Smoke No.: 2</p> <p>Menu</p>		
	<p>WARNING: DO NOT use the Fyrite[®] INSIGHT[®] Plus to sample gas from an oil-based combustion system without first doing a smoke test and adjusting your combustion process as needed. Smoke test results of greater than 1 indicate improper combustion, and demonstrate the need for process adjustment. Only use the Fyrite[®] INSIGHT[®] Plus to sample flue gas AFTER the combustion process is adjusted and the smoke test indicates a smoke level of 0 or 1.</p> 		

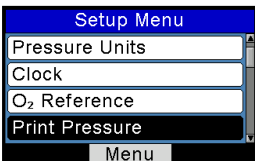
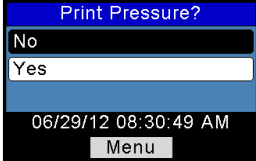
Setup Menu	Function
 <p>The screenshot shows a menu with the following items: Setup Menu, Temperature Units, Pressure Units, Smoke Number, Oil Derivative, and a Menu button at the bottom. 'Oil Derivative' is highlighted in blue.</p>	<p>Oil Derivative (Siegert only) specifies whether or not oil derivatives were present during the smoke tests (see page 34).</p> <p>For incomplete combustion, oil derivatives present in the sample can be precipitated onto the filter paper, causing a color change in the smoke spot.</p> <p>Use the UP (▲) and DOWN (▼) arrow buttons to select the YES option if oil derivatives were present during the smoke test. Otherwise select NO and press ENTER.</p>  <p>The screenshot shows a screen titled 'Oil Derivative' with two options: 'No' and 'Yes'. 'Yes' is selected and highlighted in blue. At the bottom, it shows the date and time '29/06/12 16:52:33' and two buttons: 'Menu' and 'Reset'.</p> <p>This information is included on printouts.</p>
 <p>The screenshot shows a menu with the following items: Setup Menu, Pressure Units, Smoke Number, Oil Derivative, Boiler Temperature, and a Menu button at the bottom. 'Boiler Temperature' is highlighted in blue.</p>	<p>A boiler temperature (Siegert only) can be recorded manually. Enter the boiler temperature as measured by an external thermocouple.</p> <p>Use the LEFT (◀) and RIGHT (▶) arrow buttons to change position. Use the UP (▲) and DOWN (▼) arrow buttons to scroll through numerals 0-9 for the selected position. Press ENTER when finished.</p>  <p>The screenshot shows a screen titled 'Boiler Temperature' with the value '200 °C' displayed. Below the value, it says 'Press ENTER' and has two buttons: 'Menu' and 'Reset'.</p> <p>This information is included on printouts.</p>

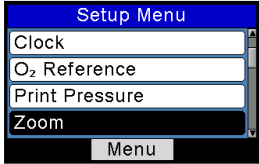
Setup Menu	Function
	<p>The Clock option provides access to the clock setup function to set date and time.</p> <p>Use the LEFT (◀) and RIGHT (▶) arrow buttons to select the desired field to edit. Then use the UP (▲) and DOWN (▼) arrow buttons to change the value of the selected field. Press ENTER to save new date and time. Press ESC to quit without saving.</p> <hr/> <p>NOTE: Siegert configurations display time and date information in DD/MM/YY and 24-hour time format only.</p> <p> Time and date information in North American configurations is user-selectable (see Date Format setting on page 49) between:</p> <ul style="list-style-type: none"> • MM/DD/YY w/ 12-hr time format or • DD/MM/YY w/ 24-hr time format. <hr/>  <hr/> <p>NOTE: The presence of AM or PM after the time on the Set Clock display indicates 12-hour time format and MM/DD/YY date format. (This also indicates that the instrument must be in the North American configuration.)</p> <p> Similarly, the absence of AM or PM indicates 24-hour time format and the date is in DD/MM/YY format (either by default if Siegert configuration, or by choice through the Date Format parameter if North American configuration).</p>

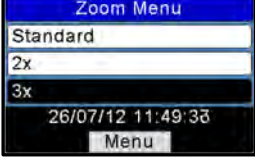
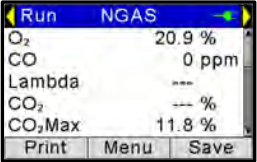
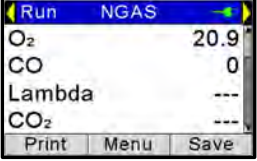
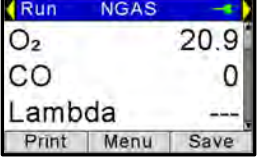
Setup Menu	Function
 <p>The screenshot shows a menu with the following items: Setup Menu, Temperature Units, Pressure Units, Clock, O₂ Reference, and a Menu button at the bottom.</p>	<p>The measured value of CO can be referenced to a specific O₂ percentage (0% to 15%) as referenced in the equation below.</p> $CO(n) = \frac{20.9 - O_2 \text{ Reference}}{20.9 - O_2 \text{ Measured}} \times CO$ <p>Use the UP (▲) and DOWN (▼) arrow buttons to enter the O₂ reference value (<i>n</i>) from 0% to 15%. Press ENTER to save the selection or ESC to revert to the previous setting.</p>  <p>The screenshot shows a screen titled 'O₂ Reference' with the text 'CO ref to O₂' and a cursor pointing to the number '3'.</p> <hr/> <p> NOTE: The O₂ reference has a default value of 0%. CO with respect to a 0% O₂ reference is also known as <i>CO Air Free</i> or CO(0).</p>
 <p>The screenshot shows a menu with the following items: Setup Menu, Pressure Units, Clock, O₂ Reference, Print Pressure, and a Menu button at the bottom.</p>	<p>Select whether to print (YES) or not print (NO) the pressure measurement on the combustion test printout.</p> <p>Use the UP (▲) and DOWN (▼) arrow buttons to select YES or NO. Press ENTER to save your choice.</p>  <p>The screenshot shows a screen titled 'Print Pressure?' with 'No' and 'Yes' options. 'Yes' is highlighted. At the bottom, it shows the date and time '06/29/12 08:30:49 AM' and a Menu button.</p>

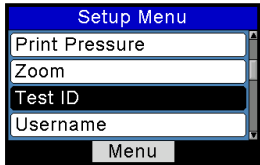

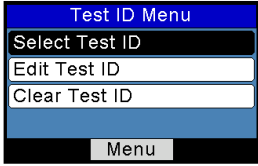

Setup Menu	Function
	<p>Combustion test data in the Run/Hold screen can be shown with enlarged characters to make viewing easier. The operator can set zoom levels to Standard, 2X or 3X.</p> <ul style="list-style-type: none"> • The Standard zoom setting will display 5 lines of combustion test data at one time. • 2X will display 4 lines of data with enlarged characters. • 3X will display 3 lines of data with enlarged characters. <p>Select the desired zoom level using the UP (▲) and DOWN (▼) arrow buttons. Press the ENTER button to save the selection, or press ESC to revert to the previous setting.</p> <div style="display: flex; flex-direction: column; align-items: center;">    </div> <div style="display: flex; flex-direction: column; align-items: center;">    </div> <p>The operator can scroll through the complete list of data (using the UP (▲) and DOWN (▼) arrow buttons) regardless of the zoom level.</p>

Setup Menu	Function
	<p>TEST ID OVERVIEW</p> <p>Test records can be identified by manually entering up to three lines of text, with each line containing a maximum of 20 alphanumeric characters representing a customer’s name, burner number, location, etc.</p> <hr/> <p> NOTE: This data can also be entered using the Fyrite® User Software (FUS).</p> <hr/> <p>From the Test ID screen, you can select, edit, and clear Test IDs.</p>  <p>SELECT TEST ID</p> <p>After a Test ID is selected, the information:</p> <ul style="list-style-type: none"> • is associated with all succeeding test records • will appear at the top of each printed test record • will appear in CSV files when records are downloaded to a PC. <p>The chosen Test ID remains in effect until it is deselected, a new Test ID is selected, or the instrument is turned off. Up to 10 Test IDs can be entered. A “No Test ID” option is also available.</p> <p>To select a Test ID to be associated with future test records, use the UP (▲) and DOWN (▼) arrow buttons to highlight the Select Test ID option and press ENTER. Then use the UP (▲) and DOWN (▼) arrow buttons to highlight your desired choice from the list of 10 Test IDs (or “No Test ID” if you don’t want to assign one). Once highlighted, press ENTER to select that Test ID.</p>

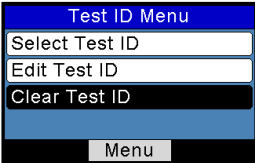
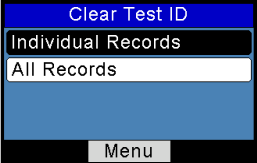
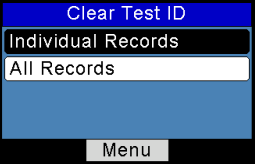
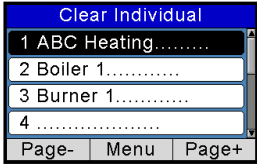
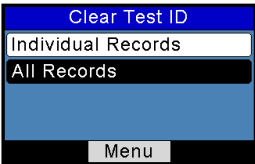
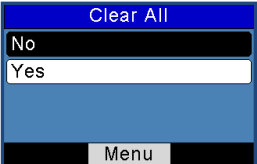
Setup Menu	Function	
	<p data-bbox="760 447 883 468">Test ID Menu</p> <p data-bbox="701 474 834 495">Select Test ID</p> <p data-bbox="701 501 818 522">Edit Test ID</p> <p data-bbox="701 529 818 550">Clear Test ID</p> <p data-bbox="792 579 850 600">Menu</p>	<p data-bbox="1029 447 1153 468">Select Test ID</p> <p data-bbox="980 474 1175 495">1 ABC Heating.....</p> <p data-bbox="980 501 1175 522">2 Boiler 1.....</p> <p data-bbox="980 529 1175 550">3 Burner 1.....</p> <p data-bbox="980 556 1175 577">4</p> <p data-bbox="980 583 1045 604">Page-</p> <p data-bbox="1062 583 1127 604">Menu</p> <p data-bbox="1143 583 1208 604">Page+</p>

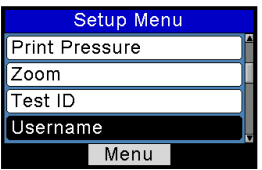

Setup Menu	Function
	<p>EDIT TEST ID</p> <hr/> <p> NOTE: This data can also be entered using the Fyrite® User Software (FUS).</p> <hr/> <p>To Edit the contents of a Test ID record, use the UP (▲) and DOWN (▼) arrow buttons to highlight the Edit Test ID option and press ENTER.</p> <div data-bbox="829 751 1084 913" style="border: 1px solid black; padding: 5px; margin: 10px 0;"> <p style="text-align: center; background-color: #0056b3; color: white; margin: 0;">Test ID Menu</p> <p style="margin: 0;">Select Test ID</p> <p style="background-color: #0056b3; color: white; margin: 0;">Edit Test ID</p> <p style="margin: 0;">Clear Test ID</p> <p style="text-align: center; margin: 0;">Menu</p> </div> <p>Use the UP (▲) and DOWN (▼) arrow buttons to highlight your desired choice from the list of 10 Test IDs (the first line of each Test ID is shown). Once highlighted, press ENTER to select that Test ID. The text associated with the selected Test ID (if any) is displayed (3 lines per Test ID) along with the EDIT COMPLETE option.</p> <div style="display: flex; justify-content: space-around; margin: 10px 0;"> <div data-bbox="688 1131 943 1293" style="border: 1px solid black; padding: 5px;"> <p style="text-align: center; background-color: #0056b3; color: white; margin: 0;">Edit Test ID</p> <p style="margin: 0;">1 ABC Heating</p> <p style="margin: 0;">2</p> <p style="margin: 0;">3</p> <p style="margin: 0;">4</p> <p style="margin: 0;">Page- Menu Page+</p> </div> <div data-bbox="954 1131 1209 1293" style="border: 1px solid black; padding: 5px;"> <p style="text-align: center; background-color: #0056b3; color: white; margin: 0;">Edit Test ID</p> <p style="margin: 0;">ABC Heating</p> <p style="margin: 0;">Boiler 1</p> <p style="margin: 0;">Burner 1</p> <p style="margin: 0;">Edit Complete</p> <p style="margin: 0;">Menu Clear</p> </div> </div> <p>Use the UP (▲) and DOWN (▼) arrow buttons to choose which of the three Test ID lines to edit and then press the ENTER key to begin editing the chosen line. Use the UP (▲) and DOWN (▼) arrow buttons to select the desired letter, number, or special character.</p> <p style="text-align: center; margin: 10px 0;">/ ! @ # \$ % & * - ' <SPACE> a-z A-Z 0-9</p> <p>Use the LEFT (◀) and RIGHT (▶) arrow buttons to move the cursor horizontally on the selected row. Press ENTER to save the row's changes. Repeat for all 3 lines. Then select EDIT COMPLETE and press ENTER to finish.</p>

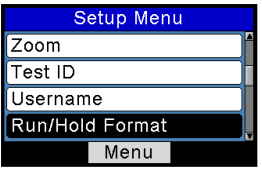

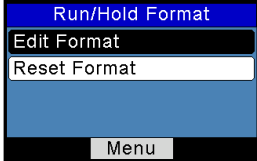
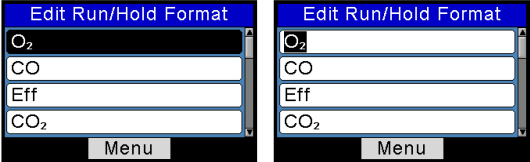

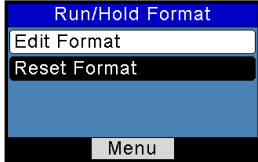
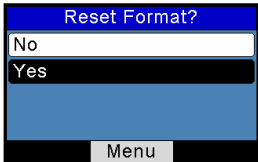
Setup Menu	Function
	<p>CLEAR TEST ID</p> <p>To clear the contents of one or more Test IDs, use the UP (▲) and DOWN (▼) arrow buttons to highlight the Clear Test ID option and press ENTER.</p> <div style="display: flex; justify-content: space-around;">   </div> <p>Use the UP (▲) and DOWN (▼) arrow buttons to highlight your desired choice:</p> <ul style="list-style-type: none"> • Individual Records • All Records. <p>Once highlighted, press ENTER.</p> <p>If “Individual Records” is selected, a list of the 10 Test IDs is displayed. Use the UP (▲) and DOWN (▼) arrow buttons to highlight the Test ID targeted for deletion. Press ENTER to clear the selected Test ID.</p> <div style="display: flex; justify-content: space-around;">   </div> <p>If “All Records” is selected, a Clear All confirmation screen is displayed. Use the UP (▲) and DOWN (▼) arrow buttons to select YES (to confirm) or NO (to cancel the deletion) then press ENTER.</p> <div style="display: flex; justify-content: space-around;">   </div>

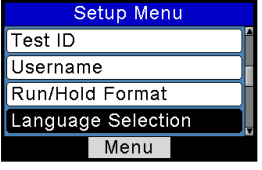
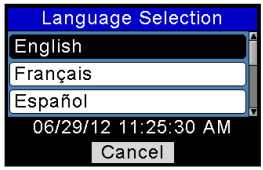
Setup Menu	Function
	<p>Provides an interface for entering user identification information used on printouts. Generally, the Username fields contain the HVAC company and related information.</p> <hr/> <p> NOTE: This data can be entered using the Fyrite® User Software (FUS).</p> <hr/> <p>Use the UP (▲) and DOWN (▼) arrow buttons to choose a row and press ENTER to begin editing the selected row. Then use the UP (▲) and DOWN (▼) arrow buttons to select the desired letter, number, or special character for the current text position.</p> <p style="text-align: center;">/ ! @ # \$ % & * - ' <SPACE> a-z A-Z 0-9</p> <p>Use the LEFT (◀) and RIGHT (▶) arrow buttons to move the cursor horizontally on the selected row and repeat the character selection process for each text position. When finished, press ENTER to save the row's changes.</p> <p>Repeat for all 3 lines. Then select EDIT COMPLETE and press ENTER to finish.</p> <div style="display: flex; justify-content: space-around;"> <div data-bbox="690 1165 950 1333">  </div> <div data-bbox="966 1165 1226 1333">  </div> </div>
	<p>RUN/HOLD Format Overview</p> <p>Allows the user to select the order in which parameters are displayed in the RUN/HOLD screen.</p> <p>The combustion parameters shown on the RUN/HOLD screen are dependent on the combustion equations (NA vs. Siegert) that are being used (see page 52 for more information). The order in which the parameters and data appear in the RUN/HOLD screen can be changed using the RUN/HOLD Format option in the Setup Menu.</p>

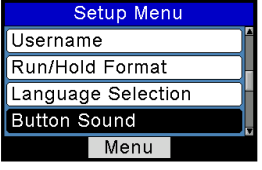
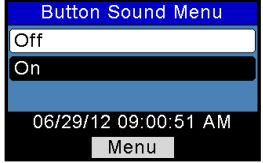
Setup Menu	Function
	<p>Changing the RUN/HOLD Format</p> <ol style="list-style-type: none"> Use the UP (▲) and DOWN (▼) arrow buttons to select EDIT FORMAT. Press ENTER to display the current format.  <ol style="list-style-type: none"> Change data for a particular location by first using the UP (▲) and DOWN (▼) arrow buttons to select the location in the list that you want to edit. Note that <i>the entire line</i> of each position is highlighted. Press ENTER when the desired row is highlighted.  <p>Note that this action causes <i>only the text portion</i> of the row to be highlighted. See above. You are now able to scroll through the list of available parameters for this position.</p> <ol style="list-style-type: none"> Use the UP (▲) and DOWN (▼) arrow buttons to scroll through and select the desired data to appear in that position of the display. Press ENTER to save the selection for that row. Change the data displayed at other locations by repeating steps 2 and 3. When finished, use the UP (▲) and DOWN (▼) arrow buttons to select EDIT COMPLETE, located at the bottom of the list. Press ENTER to save the new display format and return to the RUN/HOLD Format options.

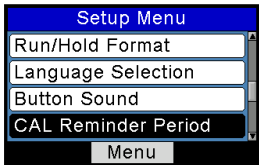
Setup Menu	Function
	<p data-bbox="727 464 769 541"></p> <p data-bbox="802 464 1214 548">NOTE: Changing the RUN/HOLD format also can be done through the Fyrite® User Software (FUS).</p> <hr data-bbox="699 562 1227 569"/> <p data-bbox="686 600 992 627">Reset Format (Factory Default)</p> <p data-bbox="686 644 1227 701">Reset the display format back to the factory default settings as follows:</p> <ol data-bbox="686 720 1227 835" style="list-style-type: none"> 1. From the SETUP MENU, use the UP (▲) and DOWN (▼) arrow buttons to select RESET FORMAT. Press ENTER to display the Reset Format confirmation prompt. <div data-bbox="846 850 1101 1010">  <p data-bbox="846 850 1101 1010">A screenshot of a menu titled "Run/Hold Format". It has two options: "Edit Format" and "Reset Format". The "Reset Format" option is highlighted with a black background. At the bottom of the screen is a "Menu" button.</p> </div> <ol data-bbox="686 1031 1227 1115" style="list-style-type: none"> 2. Use the UP (▲) and DOWN (▼) arrow buttons to select YES to confirm the reset of the RUN/HOLD display format to the factory default format. <div data-bbox="829 1129 1084 1289">  <p data-bbox="829 1129 1084 1289">A screenshot of a confirmation prompt titled "Reset Format?". It has two options: "No" and "Yes". The "Yes" option is highlighted with a black background. At the bottom of the screen is a "Menu" button.</p> </div>

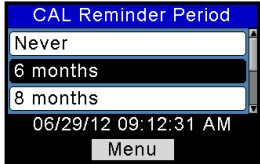

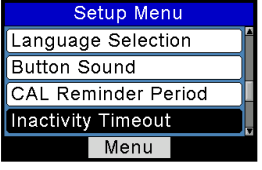
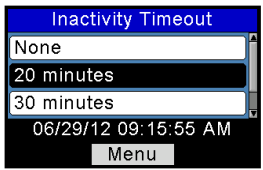
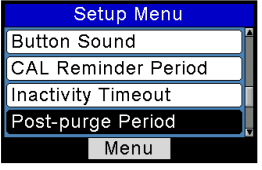
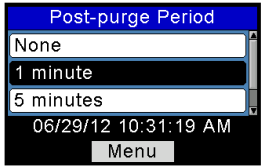

Setup Menu	Function																											
	<p>The Language Selection option allows the user to choose a language for all menus. Use the UP (▲) and DOWN (▼) arrow buttons to scroll through language options (varies based on instrument model). Use ENTER to enable the selected language.</p>  <hr/> <p> NOTE: The number of available languages may differ based on the combustion equation setting.</p> <hr/> <p>Three languages are available for North American (NA) configurations and eight languages are available for Siegert (S) configurations. Refer to the table below and the SETUP MENU for more information.</p> <table border="1" data-bbox="706 1092 1201 1302"> <thead> <tr> <th></th> <th>English</th> <th>French</th> <th>Spanish</th> <th>Polish</th> <th>German</th> <th>Italian</th> <th>Dutch</th> <th>Danish</th> </tr> </thead> <tbody> <tr> <td>NA</td> <td>•</td> <td>•</td> <td>•</td> <td></td> <td></td> <td></td> <td></td> <td></td> </tr> <tr> <td>S</td> <td>•</td> <td>•</td> <td>•</td> <td>•</td> <td>•</td> <td>•</td> <td>•</td> <td>•</td> </tr> </tbody> </table>		English	French	Spanish	Polish	German	Italian	Dutch	Danish	NA	•	•	•						S	•	•	•	•	•	•	•	•
	English	French	Spanish	Polish	German	Italian	Dutch	Danish																				
NA	•	•	•																									
S	•	•	•	•	•	•	•	•																				
	<p>The audible sound used to signal when a button is pressed can be turned OFF and ON as follows. Use the UP (▲) and DOWN (▼) arrow buttons to highlight the desired BUTTON SOUND (On or Off), and then press ENTER to select or ESC to discard changes.</p> 																											

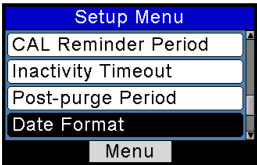
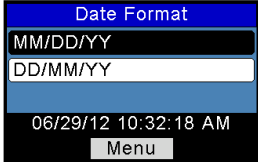
Setup Menu	Function
	<p>The analyzer can be set to indicate a calibration reminder during warmup. Calibration reminders can be disabled (set to “Never”), or set to occur at 6, 8, 10, 12, or 15 months after the last calibration. When the preset period is exceeded the instrument will display the reminder, and how long since the sensors were last calibrated. If a calibration reminder is displayed, the operator can press the RUN/HOLD key to move to the RUN/HOLD Screen for normal operation. Regular calibration periods of 6 months to 1 year are recommended.</p> <hr/> <p> NOTE: The default CAL Reminder Period is set to NEVER.</p> <hr/> <p>Set the calibration reminder period as follows:</p> <ol style="list-style-type: none"> 1. Use the UP (▲) and DOWN (▼) arrow buttons to select the desired time period. <div data-bbox="852 1041 1109 1203" style="text-align: center;">  </div> <ol style="list-style-type: none"> 2. Press ENTER to save the selection or ESC to revert to the previous setting. <hr/> <p> NOTE: The date and time settings must be correct to get accurate calibration reminders.</p> <hr/>

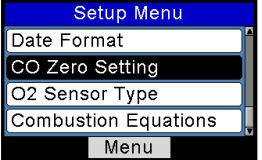
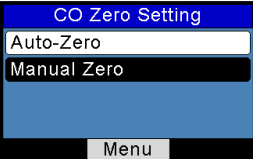
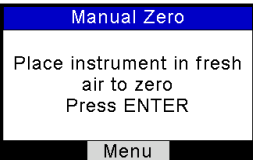
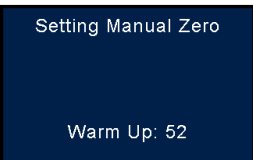
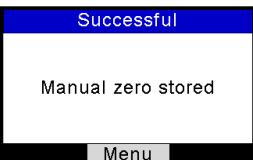
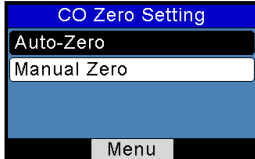
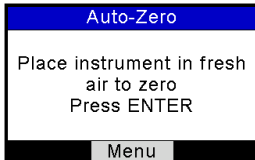
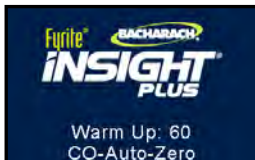
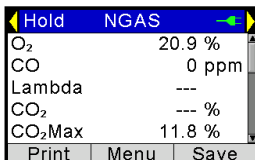
Setup Menu	Function
	<p>Provides a list from which to select an inactivity (key press) timeout for automatic shutdown. If no key presses occur for the time specified, the Fyrite® INSIGHT® Plus initiates an automatic shutdown.</p> <p>Use the UP (▲) and DOWN (▼) arrow buttons to scroll through Inactivity Timeout options (never [default], 20, 30, or 60 minutes). Use the ENTER key to enable the selected timeout.</p>  <hr/> <p>IMPORTANT: The instrument overrides the inactivity timeout, cancels the automatic shutdown (that is, the instrument remains ON), and restarts the timeout countdown if:</p> <ul style="list-style-type: none"> • any key is pressed, • CO is greater than 50 ppm, or • O₂ is less than 18.8 %.
	<p>Provides a list from which the user may chose a <i>minimum</i> purge duration time (<i>minimum</i> length of time that the pump continues to run) after shutdown is initiated. Use a longer Post-Purge Period if the Fyrite® INSIGHT® Plus has been exposed to large amounts of CO gas. "PURGING SENSORS" is displayed on the shutdown screen if a Post-Purge Period is enabled.</p> <p>Use the UP (▲) and DOWN (▼) arrow buttons to scroll through Post-purge Period options. Use ENTER to enable the selected Post-Purge Period.</p> 

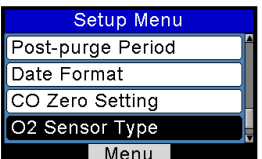
Setup Menu	Function
	<p>IMPORTANT: Never disconnect the probe from the instrument until purging is complete. Otherwise, leftover target gas (for example, CO) may remain in the probe and cause inaccurate zeroing at power up that could lead to inaccurate gas measurements afterwards.</p>
	<p>Provides a list (North American Configuration only) from which the user may select the desired date format used by the instrument:</p> <ul style="list-style-type: none"> • MM/DD/YY (default for NA configurations) • DD/MM/YY (standard for Siegert) <p>NOTE: The DD/MM/YY date format is the only format available in instruments configured with Siegert combustion equations. This parameter is only available in North American configurations.</p> <p>NOTE: In MM/DD/YY format, times are shown in 12-hour format with AM and PM (e.g., 01:23 PM). In DD/MM/YY format, times are shown in 24-hour format (e.g., 13:23).</p> <p>Use the UP (▲) and DOWN (▼) arrow buttons to highlight the desired date format. Press ENTER to save new date format. Press ESC to quit without saving. To set the current date and time, see page 36.</p> 

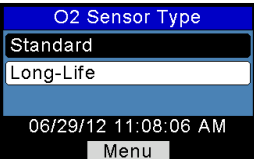
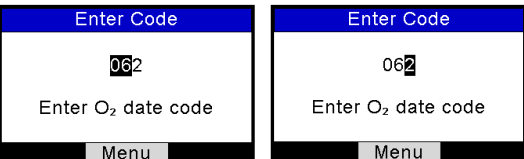
Setup Menu	Function
	<p>Provides a list from which the user may select the desired method for zeroing the CO sensor.</p> <ul style="list-style-type: none"> • <i>Auto-Zero</i> occurs automatically at warmup. • <i>Manual zero</i> is used to initiate the zeroing process whenever desired. <p>Use the UP (▲) and DOWN (▼) arrow buttons to highlight the desired zeroing method.</p> <p>Press ENTER to save. Press ESC to quit without saving.</p> <div style="display: flex; justify-content: space-around;"> <div style="width: 45%;"> <p style="text-align: center;">CO MANUAL ZERO</p>     </div> <div style="width: 45%;"> <p style="text-align: center;">CO AUTO ZERO</p>     </div> </div> <p>By default, the Fyrite[®] INSIGHT[®] Plus automatically zeroes all sensors on ambient air when the instrument is turned on.</p> <p>The Fyrite[®] INSIGHT[®] Plus can be set to perform and store a manual zero for the CO sensor. The instrument uses the stored value to indicate background CO values after warmup instead of performing an auto-zero on the background gas.</p>

Setup Menu	Function
	<p>Provides a list from which the user may select the type of O₂ sensor used in the instrument:</p> <ul style="list-style-type: none"> • Standard O₂ sensor (shown below) • Long-Life O₂ sensor. <p>Use UP (▲) and DOWN (▼) arrow buttons to highlight the installed O₂ sensor option. Press ENTER to select.</p>
	
	
	<p>Use the LEFT (◀) and RIGHT (▶) arrow buttons to move the cursor horizontally to select between the 2-digit month code (00-12) and the one digit year code (0-9 corresponding to the last digit of the manufacture year). Use UP (▲) and DOWN (▼) arrow buttons to increment and decrement the selected field's value. When finished, press ENTER to save the changes.</p>
	
	<p>Next, verify the current month and year. Use the arrow keys to edit the current month and year (if needed) and press ENTER to confirm.</p> 

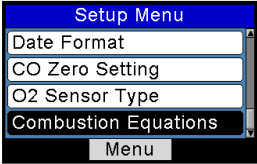
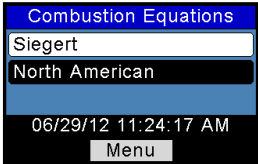
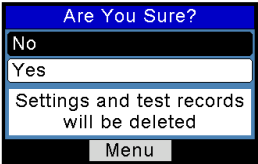
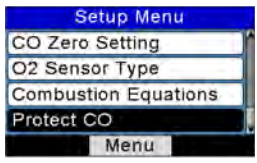

Setup Menu	Function																				
	<p>The COMBUSTION EQUATIONS menu allows the user to select either Siegert combustion equations or North American combustion equations.</p> <p>Use UP (▲) and DOWN (▼) arrow buttons to highlight the desired option. Press ENTER to select.</p>																				
																					
	<p>IMPORTANT: Changing this setting resets several configuration parameters to their default values. Below is a list of affected parameters and those unaffected.</p>																				
	<table border="1"> <thead> <tr> <th>Reset to Default Values</th> <th>Unchanged</th> </tr> </thead> <tbody> <tr> <td>Temperature units</td> <td>Manual/Auto zero</td> </tr> <tr> <td>Pressure units</td> <td>Calibration data</td> </tr> <tr> <td>O₂ (Oxygen) reference</td> <td>User name</td> </tr> <tr> <td>Print pressure</td> <td>Test ID</td> </tr> <tr> <td>Zoom</td> <td>O₂ sensor type</td> </tr> <tr> <td>Button sound</td> <td>Clock</td> </tr> <tr> <td>RUN/HOLD format</td> <td></td> </tr> <tr> <td>Fuel</td> <td></td> </tr> <tr> <td>Memory erased</td> <td></td> </tr> </tbody> </table>	Reset to Default Values	Unchanged	Temperature units	Manual/Auto zero	Pressure units	Calibration data	O ₂ (Oxygen) reference	User name	Print pressure	Test ID	Zoom	O ₂ sensor type	Button sound	Clock	RUN/HOLD format		Fuel		Memory erased	
Reset to Default Values	Unchanged																				
Temperature units	Manual/Auto zero																				
Pressure units	Calibration data																				
O ₂ (Oxygen) reference	User name																				
Print pressure	Test ID																				
Zoom	O ₂ sensor type																				
Button sound	Clock																				
RUN/HOLD format																					
Fuel																					
Memory erased																					
	<p>The CO Protect feature protects the CO sensor from the negative effects of being overloaded with CO gas. Such negative effects include:</p> <ul style="list-style-type: none"> • a longer sensor recovery time • a shortened sensor life. <p>The CO sensor is an electro-chemical sensor whose</p>																				

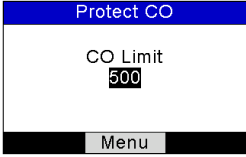
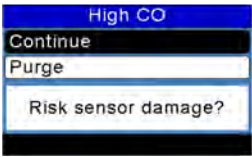
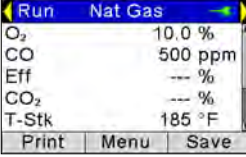

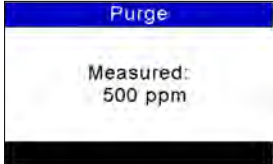

Setup Menu	Function
	<p>lifespan is a function of its exposure to the target gas (CO in this case). Though the CO sensor is designed to be used in combustion environments having a fairly wide range of CO gas present, limiting unnecessary overexposure to CO gas can greatly increase the life expectancy of the CO sensor. In addition, it can shorten sensor recovery time after exposure.</p> <div style="display: flex; justify-content: space-around;">   </div> <p>The Protect CO feature sets a protection threshold above which the analyzer’s pump shuts off, limiting the CO sensor’s exposure to the high levels of CO gas and its negative effects. Enter the Protect CO screen from the Setup Menu. Select the “ON” option and press the ENTER key. The CO threshold limit is displayed. Use the up and down arrows to modify the CO limit threshold value (in 100 ppm increments) before returning to the Main Menu.</p> <p>During combustion analysis, if the Protect CO feature is enabled and the CO reading equals or exceeds the CO Limit setting, the analyzer shuts off the pump and prompts the operator for a course of action.</p> <ul style="list-style-type: none"> • Continue (and risk sensor damage) • Purge <p>Continue Option:</p> <ul style="list-style-type: none"> • Pump starts. • Future High CO warnings are suppressed until CO drops below 100 ppm. <div style="display: flex; justify-content: space-around;">   </div> <ul style="list-style-type: none"> • After CO drops below 100 ppm, the analyzer begins enforcing the current Protect CO threshold limit again.

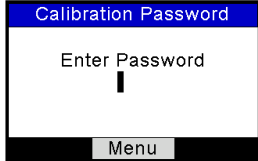
Setup Menu	Function
	<p>Purge Option:</p> <ul style="list-style-type: none"> Remove probe tip from flue and press ENTER.  <ul style="list-style-type: none"> Pump starts. Purge begins. Measured CO is displayed.  <ul style="list-style-type: none"> Purge ends when CO level drops below 50 ppm.

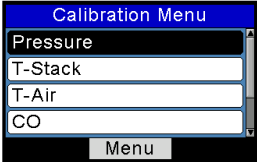
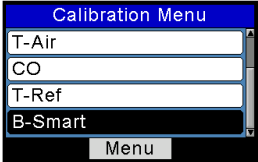
3.12. Calibration Menu

Calibration Menu	Function
 <p>A screenshot of the 'Calibration Password' screen. The title bar is blue with white text. The main area is white with the text 'Enter Password' and a vertical cursor. At the bottom is a grey 'Menu' button.</p>	<p>Calibration is performed by applying known values and accessing the password-protected menu items. When the Calibration Menu is selected, the user must enter a 4-digit numeric security code in order to proceed to the calibration options. The default password is 1111.</p> <p>Use the UP (▲) and DOWN (▼) arrow buttons to scroll through numerals 0-9 until the desired numeral is reached. Press ENTER to advance to the next position of the password. Press ENTER after all four digits are set. Press ESC to return to the SETUP MENU.</p> <div data-bbox="829 825 1084 984" style="text-align: center;">  <p>A smaller version of the 'Calibration Password' screen screenshot.</p> </div> <hr/> <p> NOTE: The calibration password can be changed through the Fyrite® User Software (FUS).</p> <hr/> <div style="display: flex; justify-content: space-around;"> <div data-bbox="696 1209 951 1369" style="text-align: center;">  <p>A screenshot of the 'Calibration Menu' with 'Pressure' selected. The list includes Pressure, T-Stack, T-Air, and CO.</p> </div> <div data-bbox="967 1209 1222 1369" style="text-align: center;">  <p>A screenshot of the 'Calibration Menu' with 'T-Air' selected. The list includes T-Air, CO, T-Ref, and B-Smart.</p> </div> </div> <p>Refer to Chapter 5 for additional screens and calibration procedures.</p> <ul style="list-style-type: none"> • Pressure Calibration see page 86 • T-Stack Calibration see page 88 • T-Air Calibration see page 90 • CO Calibration see page 93 • T-Ref Calibration..... see page 95 • B-SMART® Calibration see page 85

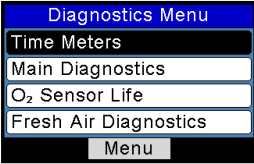
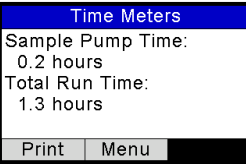
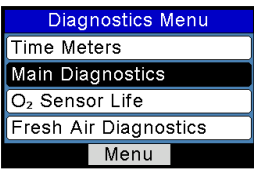
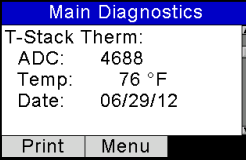
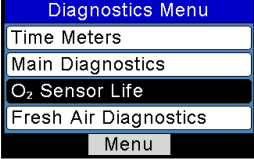
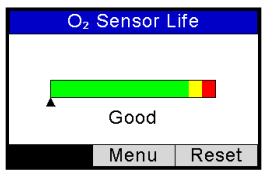
3.13. Diagnostics Menu

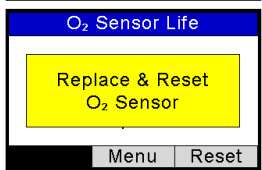
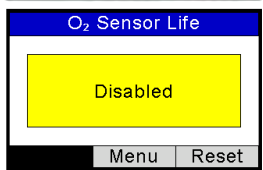
Diagnostics Menu	Function
	<p>Displays time metrics for pump use and total operation time.</p> 
	<p>Displays information about the sensors of the instrument.</p> 
	<p>Displays the <i>estimated</i> oxygen (O₂) sensor life based on:</p> <ul style="list-style-type: none"> • the sensor type (standard or long-life) that you enter • the sensor’s 3-digit date code that you enter (from the label on the sensor) • the current date that you set • the typical O₂ sensor life of approximately 24 months (or 36 months for the long-life sensor). <div style="display: flex; flex-wrap: wrap;"> <div style="width: 50%;">  </div> <div style="width: 50%;">  </div> <div style="width: 50%;">  </div> <div style="width: 50%;">  </div> </div>

Diagnostics Menu	Function
	<p>When the O₂ life reaches the end of the graph segment, an error message is displayed (see below).</p> <div data-bbox="831 510 1084 672" style="border: 1px solid black; padding: 5px; text-align: center;"> <p>O₂ Sensor Life</p> <div style="border: 1px solid black; background-color: yellow; padding: 5px; margin: 5px auto; width: 80%;"> <p>Replace & Reset O₂ Sensor</p> </div> <p>Menu Reset</p> </div> <p>In this case:</p> <ul style="list-style-type: none"> • Note the 3-digit date code on the new sensor • Replace the O₂ sensor • Press F3 to change and verify sensor date code. <p>Resetting the Sensor Date Code</p> <p>Use the LEFT (◀) and RIGHT (▶) arrow buttons to move the cursor horizontally to select between the 2-digit month code (00-12) and the one digit year code (0-9 corresponding to the last digit of the manufacture year) that make up the 3-digit date code.</p> <p>Use UP (▲) and DOWN (▼) arrow buttons to increment and decrement the selected field's value. When finished, press ENTER to save the changes.</p> <div style="display: flex; justify-content: space-around;"> <div data-bbox="696 1100 950 1262" style="border: 1px solid black; padding: 5px; text-align: center;"> <p>Enter Code</p> <p>060</p> <p>Enter O₂ date code</p> <p>Menu</p> </div> <div data-bbox="966 1100 1219 1262" style="border: 1px solid black; padding: 5px; text-align: center;"> <p>Enter Code</p> <p>062</p> <p>Enter O₂ date code</p> <p>Menu</p> </div> </div> <hr/> <div style="display: flex; align-items: center;">  <p>NOTE: Entering a value of 000 (three zeros) disables this feature.</p> </div> <hr/> <p>Next, verify the current month and year. Use the arrow keys to edit the current month and year (if needed) and press ENTER to confirm.</p> <div style="display: flex; justify-content: space-around;"> <div data-bbox="690 1547 943 1709" style="border: 1px solid black; padding: 5px; text-align: center;"> <p>Set Clock</p> <p>07/2012</p> <p>Verify the month/year</p> <p>Menu</p> </div> <div data-bbox="956 1547 1209 1709" style="border: 1px solid black; padding: 5px; text-align: center;"> <p>Set Clock</p> <p>07/2012</p> <p>Verify the month/year</p> <p>Menu</p> </div> </div>

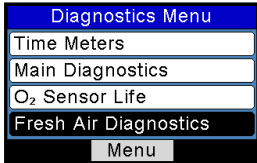
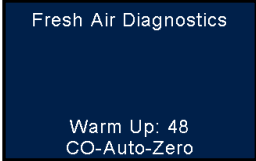
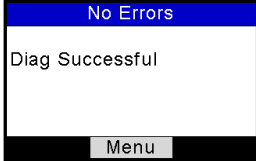
Diagnostics Menu	Function
	<p>NOTE: Use this feature as a reminder only. This status is based on:</p> <ul style="list-style-type: none"> the date code on the sensor (that you enter) the current date (that you enter) the typical O₂ life span (2 years) the output of the sensor <p>If either of the entered values is incorrect, the status of your O₂ sensor life will not be accurate. Actual sensor life may vary.</p>
	<p>Displays fresh air diagnostics similar to the display at warm-up. After the warm-up countdown, any detected errors are displayed. Otherwise, a “Success” message is displayed. Refer to page 96 for a list of errors.</p> <div style="display: flex; justify-content: space-around;"> <div data-bbox="696 1008 950 1167">  </div> <div data-bbox="966 1008 1219 1167">  </div> </div>

3.14. Status Menu

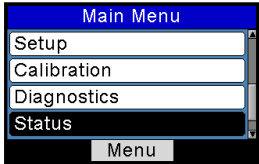
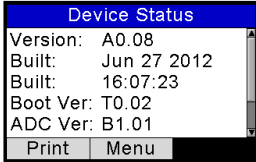
Status Menu	Function
 <p>Main Menu Setup Calibration Diagnostics Status Menu</p>	<p>This is the device status screen which displays information about the device. Some of the information displayed on this screen includes serial number, firmware version, model number, etc.</p>  <p>Device Status Version: A0.08 Built: Jun 27 2012 Built: 16:07:23 Boot Ver: T0.02 ADC Ver: B1.01 Print Menu</p>

▽ ▽ ▽

Section 4. Operation

4.1. Prerequisites

Before beginning your combustion test, verify the following:

- menu items are properly configured
- the water trap is empty, filter is clean, and arrow is pointing UP
- the probe and thermocouple are attached to the instrument
- the power is ON and sufficient (one of the following):
 - AC wall adapter
 - USB cable to PC
 - four new batteries (AA alkaline or lithium)
 - four fully-charged AA rechargeable batteries
- the warm-up process has completed in fresh air without interruption or errors.

4.2. Sampling Point Examples



WARNING: The illustrations of combustion devices and sampling points in this section are examples only. Be sure to consult with the manufacturer's documentation for the combustion devices you are servicing.

The following combustion devices and example sampling points are shown and explained below:

- Example forced air furnace
- Example hot water tank
- Example 90% efficiency condensing furnace
- Example 80% efficiency fan assist or power vented furnace
- Example atmospheric/gravity vented boiler

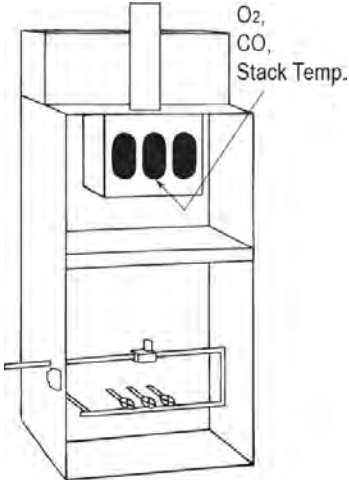
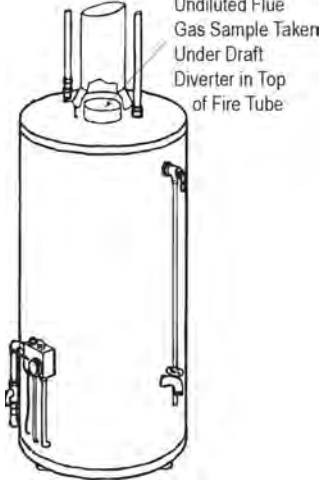
Example Forced Air Furnace	Example Hot Water Tank
 <p data-bbox="391 978 800 1234">For atmospheric burner or gravity vented, forced air heating equipment with a clamshell or sectional heat exchanger design, test each of the exhaust ports at the top of the heat exchanger. The probe should be inserted back into each of the exhaust ports to obtain a flue gas sample, before any dilution air is mixed in.</p>	 <p data-bbox="821 978 1230 1119">Domestic hot water tanks with the 'bell' shaped draft diverter can be accurately tested by inserting the probe tip directly into the top of the fire tube below the diverter.</p>

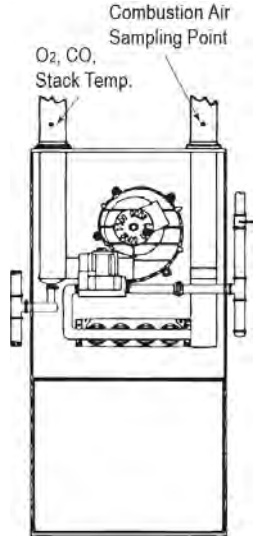
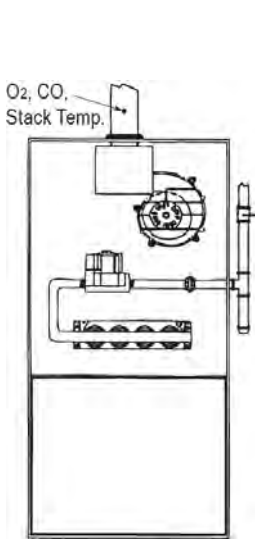
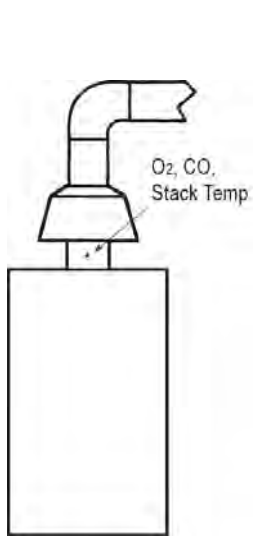
Example 90% Efficiency Condensing Furnace	Example 80% Efficiency Fan Assist or Power Vented Furnace	Example Atmospheric/Gravity Vented Boiler
 <p>Combustion Air Sampling Point O₂, CO, Stack Temp.</p> <p>Condensing furnaces/boilers can be tested through a hole drilled in the plastic vent pipe (when allowed by the manufacturer or local authority of jurisdiction) or taken from the exhaust termination.</p>	 <p>O₂, CO, Stack Temp.</p> <p>Combustion testing of fan assist or power vented, furnaces/boilers should be done through a hole drilled in the vent immediately above the inducer fan.</p>	 <p>O₂, CO, Stack Temp.</p> <p>Boilers, which have a 'bell' shaped draft diverter on top, should be tested directly below the diverter through a hole drilled in the vent connector.</p>



IMPORTANT: Review manufacturer recommendations for the combustion device being tested, and be aware of accepted practices of the local jurisdiction before introducing sampling holes into exhaust pipes or ducts.



CAUTION: To avoid the introduction of dangerous exhaust gases into the space, be sure to completely and securely seal any sampling holes made in the exhaust pipes or ducts.

4.3. Combustion Testing Process



WARNING: The Fyrite[®] INSIGHT[®] Plus calculates combustion parameters based on North American or Sievert combustion equations. NA or Sievert configuration is selected in the SETUP MENU. Be sure that your Fyrite[®] INSIGHT[®] Plus is properly configured for your region and desired combustion calculations.

Step	Example Combustion Testing Procedure
1	Confirm that testing prerequisites have been completed (see page 61).
2	Based on the sampling point examples (see page 61) and your combustion application, locate and prepare an appropriate sampling point.
3	Insert the probe into the combustion location.
4	Press the RUN/HOLD button to begin sampling gas. You should see the word RUN in the upper left corner of the display and hear the sample pump turn on. If you see the word HOLD, press the RUN/HOLD button again.
5	Monitor the display for combustion data.
6	If desired, turn on your optional IrDA printer, then press the F1 button on the Fyrite [®] INSIGHT [®] Plus to print the current combustion data. (See page 69 for additional printing information.)
7	Press the F3 button as desired to save combustion data for later retrieval, review, and/or printing.
8	Press the RUN/HOLD button to stop the test. You should see the word HOLD in the upper left corner of the display and hear the sample pump turn OFF. If you see the word RUN, press the RUN/HOLD button again. (You may optionally choose to print test data while in HOLD mode.)
9	Remove the probe from the sampling point and disconnect the probe. <div style="text-align: center;">  <p>CAUTION: The probe may be very hot. Allow it to cool, then wipe it clean with a dry cloth.</p> </div>
10	Move the instrument to a clean air environment and press the POWER button to turn off the instrument. The shutdown procedure includes a purge component that clears the sensors of combustion gases.

Step	Example Combustion Testing Procedure
11	Turn on the instrument to optionally print and/or evaluate saved test results (based on your local codes and practices for combustion data and CO levels).
12	To turn off the Fyrite [®] INSIGHT [®] Plus, press and hold the POWER button until you see the Shutdown timer. Wait for the purge function to complete (you will hear the pump stop and the display will shut off).

Use the results of your combustion testing to assist in diagnosing any issues or potential issues that may exist with the combustion system.



NOTE: The recommended time required to achieve a stable measurement is a minimum of 3 minutes.



WARNING: CO gas is life-threatening and part of all combustion processes. Be sure to thoroughly evaluate systems and take ALL appropriate actions to maintain life safety.

4.4. The RUN Screen

The Fyrite® INSIGHT® Plus test data is located in the Run screen. By pressing the RUN/HOLD button, you should hear the pump running and see the word RUN at the upper-left hand corner of the display. The instrument is continuously measuring and calculating the data that is shown in the Run screen.

Press the RUN/HOLD button again. The pump should stop running and the word HOLD should be shown at the upper-left hand corner of the display. The instrument now shows the last measured and calculated data taken before the instrument was placed in HOLD.

Use the UP (▲) and DOWN (▼) arrow buttons to scroll through the complete list of measured and calculated values when the instrument is running or in the HOLD mode.

Combustion Test Parameters	NA	Siebert
Oxygen	O ₂	O ₂
Carbon Monoxide	CO	CO
Excess Air	EA	Lambda
Efficiency Using Higher Heating Value	Eff	Eff
Carbon Dioxide	CO ₂	CO ₂
Setting for Maximum Carbon Dioxide in Flue Gas		CO ₂ Max
Stack Temperature	T-STK	T-STK
Ambient Air Temperature	T-AIR	T-AIR
Stack Loss		qA
Efficiency Using Lower Heating Value		Eta
Carbon Monoxide/Carbon Dioxide Ratio		CO/CO ₂
CO content referenced to an Oxygen percentage <i>n</i>	CO(n)	CO(n)
Average of 3 Manually Entered Smoke Numbers		AVG SMOKE
Presence of Oil Derivatives (Manually Entered)		OIL DERIVE
Boiler Temperature (Manually Entered)		BOILER TEMP

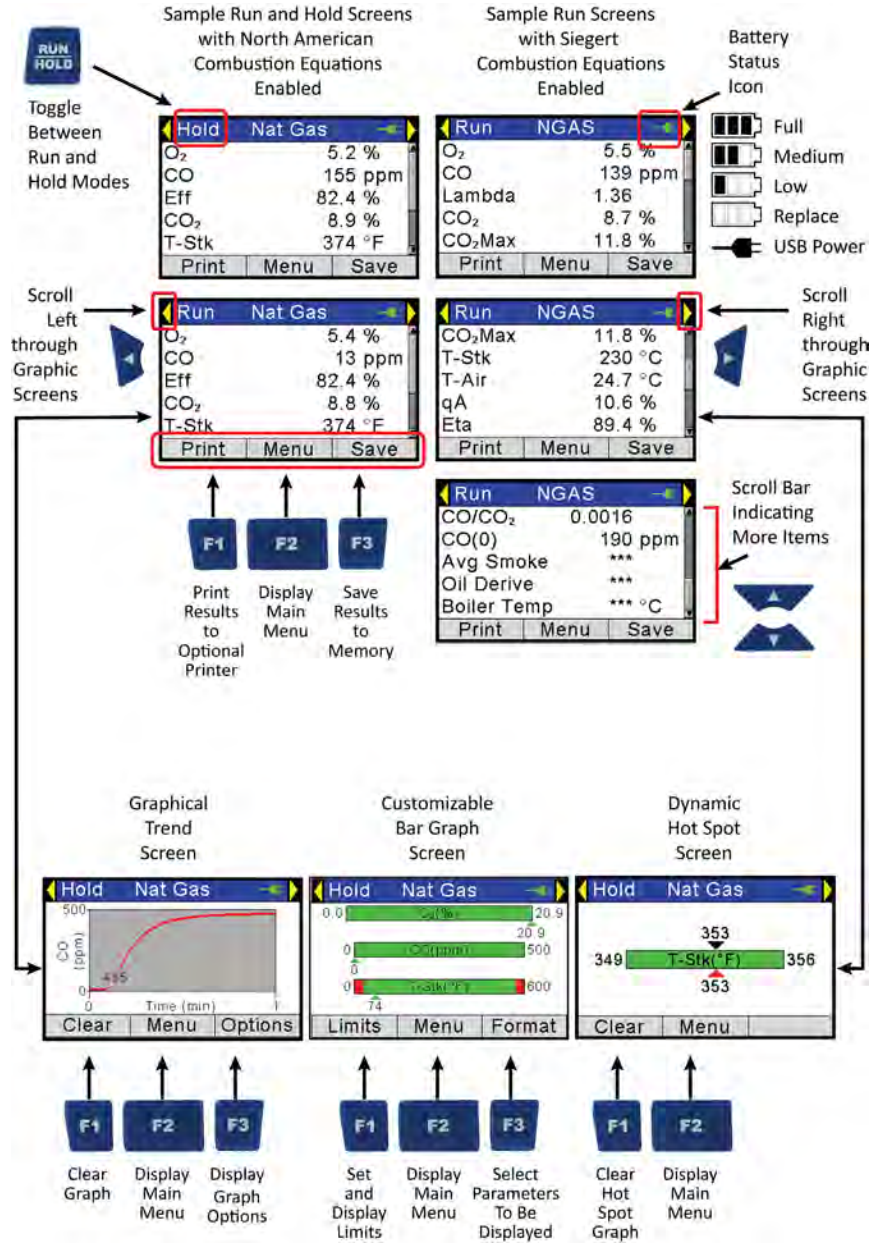

4.5. Making a Draft or Pressure Measurement

The difference in pressure (ΔP) between two areas can be measured by using the analyzer's two pressure ports and the PRESSURE screen. By using the $-\Delta P$ port as the reference, the pressure applied to the $+\Delta P$ port will be displayed on the PRESSURE screen as the differential pressure between the two ports. Perform a draft/pressure measurement as follows.

Step	Example Draft or Pressure Measurement Procedure
1	Confirm that testing prerequisites have been completed (see page 61).
2	Display the MAIN MENU by pressing the MENU (F2) button. If necessary, press ESC until MENU appears above F2.
3	Use the UP (\blacktriangle) and DOWN (\blacktriangledown) arrow buttons to select PRESSURE. Press ENTER to display the Pressure screen.
4	<p>Before taking a measurement, the pressure sensor may need to be re-zeroed if it is not already displaying zero with both pressure ports open to the atmosphere. If necessary, zero the pressure sensor as follows:</p> <ul style="list-style-type: none"> • Press the ZERO (F2) button. • Disconnect any hoses connected to the $+\Delta P$ and $-\Delta P$ ports, and then press ENTER to zero the pressure sensor. • Reconnect any hoses. When measuring draft, leave the $-\Delta P$ port open to the atmosphere and connect the probe's draft hose to the $+\Delta P$ port.
5	<p>Do one of the following to measure draft or differential pressure:</p> <ul style="list-style-type: none"> • To measure draft, insert the probe into the stack and observe the draft reading on the PRESSURE screen. • To measure differential pressure, connect sampling hoses to the $+\Delta P$ and $-\Delta P$ ports, and place the ends of the hoses into the two areas being compared. The differential pressure between the two areas is now displayed on the PRESSURE screen. If the pressure at the $+\Delta P$ port is higher than the $-\Delta P$ port, the pressure reading will be positive. If it is lower, the reading will be negative.

4.6. Printing Using the Optional IrDA Printer

The instrument has the ability to store, recall (to the display), and print sets of time- and date-coded test records. The time and date are set through software menu selections (see page 36).

- Displaying stored records is done through the MEMORY DIRECTORY MENU (see page 30).
- Press F1 to print displayed test records.

Step	Example Printing Procedure Using Optional IrDA Printer
1	Fyrite® INSIGHT® Plus should be turned on and displaying a screen with an F1 Print option.
2	Check for a sufficient supply of paper and batteries in the IrDA printer.
3	Turn on the printer (slide switch on side of printer to the ON position)
4	Position the printer within 8 to 16 inches (20 to 41 cm) from the instrument and at no greater than a 60-degree angle (see page 71).
5	Press F1 to print and turn off printer when complete.

Sample Run Screen Printouts for North American (left) and Siegert (right) Combustion Equations are shown below.

Fyrite® INSIGHT® Plus provides three lines of 20 characters for user information. This information will appear with test records when they are printed or downloaded. User name and optional information are entered via software menu selections in the SETUP MENU (see page 43) or via the Fyrite® User Software (FUS).



```

ABC Heating and A/C
123 Plenum Parkway
Checking CO 12345

BACHARACH

BACHARACH, Inc.
Insight Plus
SN: AB1234

=====

Time: 06:47:23 PM
Date: 07/20/12

      Fuel
      Nat. Gas

O2          7.0 %
CO           107 ppm
Eff          80.9 %
CO2        7.9 %
T-STK       374 °F
T-AIR       68.0 °F
EA          44.8 %
CO<O>       161 ppm

-----

Comments:
    
```

```

Bridge Street HVAC
Outer Kensington West
London, ENG SW1J 3

BACHARACH

BACHARACH, Inc.
Insight Plus
SN: AB1234

=====

Time: 18:47:23
Date: 20/07/12

      Fuel
      NGAS

O2          7.0 %
CO           107 ppm
Lambda       1.5
CO2        7.8 %
CO2 Max    11.8 %
T-STK       190 °C
T-AIR       20.0 °C
qA           9.5 %
Eta          90.5 %
Eff          80.9 %
CO/CO2      0.0014
CO<O>       161 ppm
AVG SMOKE   ***
OIL DERIV   ***
BOILER TEMP *** °C

-----

Comments:
    
```



NOTE: The printout order of parameters matches any RUN/HOLD format changes that have been made (see page 43).

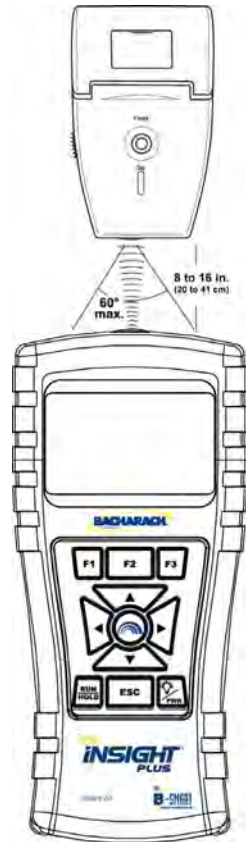

IR Communications Settings:

- Baud Rate: 9600
- Data Bits: 8
- Stop Bits: 1
- Parity: None
- Protocol: IRDA-SIR
- Distance: 8-16 in (20-41 cm)
- Angle: 60° maximum

Fyrite[®] INSIGHT[®] Plus can be setup to include a custom logo on printouts. Logos are loaded into the instrument using the Fyrite[®] User Software (FUS). Logo size is limited to 192 x 384 pixels (height x width) and must be in .BMP, .JPG, .PNG, or .TIFF format. For best results, the logo should be saved in black and white.

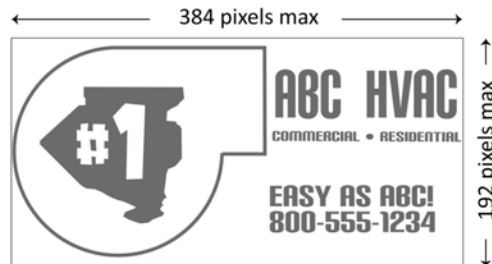

4.7. Graphics Screens

4.7.1. Overview

Dynamic graphics screens provide an alternative way of viewing key combustion data and parameters in real time. The Fyrite[®] INSIGHT[®] Plus displays three graphics screens which provide continuous updates and are described in the table that follows. The screens are accessed from the RUN/HOLD screen by using the LEFT (◀) and RIGHT (▶) arrow buttons. See the figure below.

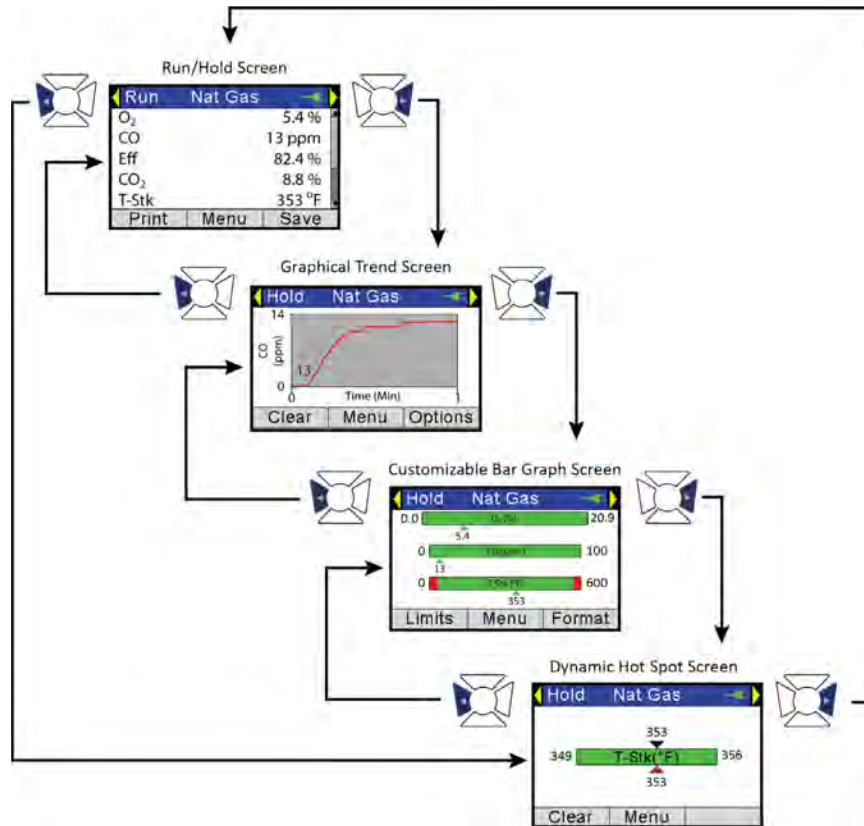

Use function keys F1 and F3 to configure and define options (if available) such as alarm points, parameters to be monitored, timing parameters, etc. Components of the graphics screens are identified in the sections that follow.

Screen	Description
Graphical “Line Graph” Trend Screen	<ul style="list-style-type: none"> User-selectable combustion parameter User-selectable time period
Bar Graph Screen	<ul style="list-style-type: none"> 1, 2, or 3 bar graphs User-selectable combustion parameter for each bar User-selectable limits for each parameter
Stack Temperature Hot Spot Screen	<ul style="list-style-type: none"> Used to dynamically locate “hot spot” in flue Based on stack temperature readings Use probe stop to maintain optimal probe position

4.7.2. Graphical Line Graph Trend Screen

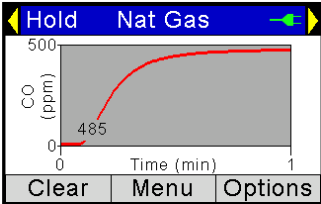
Trend Screen	Description
Graph	<ul style="list-style-type: none"> Graphical representation of a user-selected combustion parameter (from list) over a user-defined time period (from list) Current value is shown numerically on the graph Dynamic graph window provides continuous updates 
Left Arrow	<ul style="list-style-type: none"> Press the LEFT (◀) arrow to go to the main RUN/HOLD Screen.
Right Arrow	<ul style="list-style-type: none"> Press the RIGHT (▶) to go to the Bar Graph Screen.
Y Axis	<ul style="list-style-type: none"> Label shows user-selected combustion parameter, units, and range values. The display range values at the top and bottom of the Y axis are assigned in real time and are based on the selected combustion parameter and its range of values over the selected time period.
X Axis	<ul style="list-style-type: none"> Label shows “Time”, the selected time units (sec or min), and the associated range values (30 sec, 1 min, 3 min, 5 min, and 15 min). The time value in the window scrolls.
Clear (F1)	<ul style="list-style-type: none"> Press the F1 button to clear the graph and restart if in Run mode.
Menu (F2)	<ul style="list-style-type: none"> Press the F2 button to return to the main menu.

Trend Screen	Description
Options (F3)	<ul style="list-style-type: none"> Press the F3 button to define options for the trend screen. The LINE GRAPH PARAMETER option is used to select the combustion parameter (from a list) to be graphed over time. <div style="display: flex; justify-content: space-around;"> <div style="border: 1px solid black; padding: 5px; width: 45%;"> <p style="text-align: center; background-color: blue; color: white; margin: 0;">Line Graph Options</p> <p style="background-color: black; color: white; padding: 2px;">Line Graph Parameter</p> <p style="background-color: black; color: white; padding: 2px;">Line Graph Time</p> <p style="text-align: center; background-color: gray; margin: 5px 0;">Menu</p> </div> <div style="border: 1px solid black; padding: 5px; width: 45%;"> <p style="text-align: center; background-color: blue; color: white; margin: 0;">Line Graph Parameter</p> <p style="background-color: black; color: white; padding: 2px;">O₂</p> <p style="background-color: black; color: white; padding: 2px;">CO</p> <p style="background-color: black; color: white; padding: 2px;">Eff</p> <p style="background-color: black; color: white; padding: 2px;">CO₂</p> <p style="text-align: center; background-color: gray; margin: 5px 0;">Menu</p> </div> </div> <ul style="list-style-type: none"> The LINE GRAPH TIME option defines the full-scale X-axis sample time over which the graph is plotted. <div style="display: flex; justify-content: space-around;"> <div style="border: 1px solid black; padding: 5px; width: 45%;"> <p style="text-align: center; background-color: blue; color: white; margin: 0;">Line Graph Options</p> <p style="background-color: black; color: white; padding: 2px;">Line Graph Parameter</p> <p style="background-color: black; color: white; padding: 2px;">Line Graph Time</p> <p style="text-align: center; background-color: gray; margin: 5px 0;">Menu</p> </div> <div style="border: 1px solid black; padding: 5px; width: 45%;"> <p style="text-align: center; background-color: blue; color: white; margin: 0;">Line Graph Time</p> <p style="background-color: black; color: white; padding: 2px;">30 seconds</p> <p style="background-color: black; color: white; padding: 2px;">1 minute</p> <p style="background-color: black; color: white; padding: 2px;">3 minutes</p> <p style="background-color: black; color: white; padding: 2px;">5 minutes</p> <p style="text-align: center; background-color: gray; margin: 5px 0;">Menu</p> </div> </div>

4.7.3. Bar Graph Screen

Bar Graph Component	Description	
Bar Graphs 1-3	North American	Siegert
Defaults		
Example Combustion Screens		
	<ul style="list-style-type: none"> User-selected parameter name shown in bar graph. Limits are defined by the user. Bar graph limits correspond to parameter range. Dynamic “current value” indicates real-time reading. 	

Bar Graph Component	Description																				
	<ul style="list-style-type: none"> Color of “current value” pointer is based on limit status: Green: Between upper and lower limit Red: Outside upper or lower limit User-defined limits shown on bar graph in red and green. Display range adjusts to real-time values. 																				
Left Arrow	<ul style="list-style-type: none"> Press the LEFT (◀) arrow to go to the Line Graph Trend screen. 																				
Right Arrow	<ul style="list-style-type: none"> Press the RIGHT (▶) arrow to go to the Stack Temperature Hot Spot Screen. 																				
Limits (F1)	<ul style="list-style-type: none"> Used to enter user-defined upper and lower limits for selected combustion parameters. Use the UP (▲) and DOWN (▼) arrow buttons to highlight desired parameter. Press ENTER button to select the desired parameter. <div data-bbox="771 892 1040 1066" style="border: 1px solid black; padding: 5px; margin: 10px 0;"> <p style="text-align: center; background-color: #000080; color: white; margin: 0;">Select Parameter</p> <table border="1" style="width: 100%; border-collapse: collapse;"> <tr><td style="padding: 2px;">O₂</td></tr> <tr><td style="padding: 2px;">CO</td></tr> <tr><td style="padding: 2px;">Eff</td></tr> <tr><td style="padding: 2px;">CO₂</td></tr> </table> <p style="text-align: center; margin: 0;">Menu</p> </div> <ul style="list-style-type: none"> Use the LEFT (◀) and RIGHT (▶) arrow buttons to select the desired position within the upper and lower limits. Use the UP (▲) and DOWN (▼) arrow buttons to change the value. Press ENTER when finished. Press ESC to exit with no changes. <div style="display: flex; justify-content: space-around; margin: 10px 0;"> <div data-bbox="630 1192 899 1367" style="border: 1px solid black; padding: 5px;"> <p style="text-align: center; background-color: #000080; color: white; margin: 0;">Graph Limits O₂</p> <table style="width: 100%; border-collapse: collapse;"> <tr><td style="padding: 2px;">Upper:</td><td style="padding: 2px; text-align: right;">20.9 %</td></tr> <tr><td style="padding: 2px;">Lower:</td><td style="padding: 2px; text-align: right;">00.0 %</td></tr> <tr><td colspan="2" style="text-align: center; padding: 5px;">Press ENTER</td></tr> <tr><td style="text-align: center; padding: 2px;">Menu</td><td style="text-align: center; padding: 2px;">Reset</td></tr> </table> </div> <div data-bbox="915 1192 1185 1367" style="border: 1px solid black; padding: 5px;"> <p style="text-align: center; background-color: #000080; color: white; margin: 0;">Graph Limits CO</p> <table style="width: 100%; border-collapse: collapse;"> <tr><td style="padding: 2px;">Upper:</td><td style="padding: 2px; text-align: right;">0500 ppm</td></tr> <tr><td style="padding: 2px;">Lower:</td><td style="padding: 2px; text-align: right;">0000 ppm</td></tr> <tr><td colspan="2" style="text-align: center; padding: 5px;">Press ENTER</td></tr> <tr><td style="text-align: center; padding: 2px;">Menu</td><td style="text-align: center; padding: 2px;">Reset</td></tr> </table> </div> </div> <ul style="list-style-type: none"> Use the RESET function (F3) to return to default values. 	O ₂	CO	Eff	CO ₂	Upper:	20.9 %	Lower:	00.0 %	Press ENTER		Menu	Reset	Upper:	0500 ppm	Lower:	0000 ppm	Press ENTER		Menu	Reset
O ₂																					
CO																					
Eff																					
CO ₂																					
Upper:	20.9 %																				
Lower:	00.0 %																				
Press ENTER																					
Menu	Reset																				
Upper:	0500 ppm																				
Lower:	0000 ppm																				
Press ENTER																					
Menu	Reset																				
Menu (F2)	<ul style="list-style-type: none"> Press the F2 button to return to the Main menu. 																				

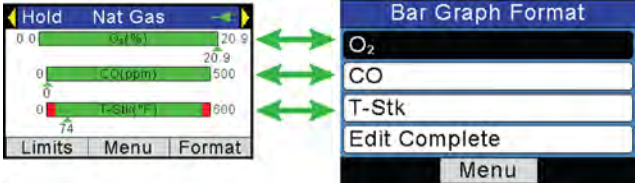
Bar Graph Component	Description
Format (F3)	<ul style="list-style-type: none"> Press F3 to display the Bar Graph format screen. It contains three bar graph options—each of which defines the combustion parameter associated with that graph. A fourth option is selected when editing is complete. Use the UP (▲) and DOWN (▼) arrow buttons to highlight one of the rows corresponding to the three bar graphs (top, middle, or bottom) (see left, below). Note that <i>the entire line</i> of each position is highlighted. <div style="text-align: center;">  </div> <p>When the desired row is highlighted, press ENTER to enter EDIT mode for bar graph associated with that row. Note that this action causes <i>only the text portion</i> of the row to be highlighted (not the entire row). See right, below. Then use the UP (▲) and DOWN (▼) arrow buttons to scroll through available combustion parameters to monitor for the bar graph associated with that row. Press ENTER to select.</p> <div style="display: flex; justify-content: space-around; align-items: center;"> <div style="border: 1px solid black; padding: 5px; width: 150px;"> <p style="text-align: center; background-color: #0056b3; color: white; margin: 0;">Bar Graph Format</p> <div style="background-color: #0056b3; color: white; padding: 2px;">O₂</div> <div style="border: 1px solid #0056b3; padding: 2px;">CO</div> <div style="border: 1px solid #0056b3; padding: 2px;">T-Stk</div> <div style="border: 1px solid #0056b3; padding: 2px;">Edit Complete</div> <div style="text-align: center; background-color: #cccccc; margin-top: 5px;">Menu</div> </div> <div style="border: 1px solid black; padding: 5px; width: 150px;"> <p style="text-align: center; background-color: #0056b3; color: white; margin: 0;">Bar Graph Format</p> <div style="border: 1px solid #0056b3; padding: 2px;">O₂</div> <div style="border: 1px solid #0056b3; padding: 2px;">CO</div> <div style="border: 1px solid #0056b3; padding: 2px;">T-Stk</div> <div style="border: 1px solid #0056b3; padding: 2px;">Edit Complete</div> <div style="text-align: center; background-color: #cccccc; margin-top: 5px;">Menu</div> </div> </div> <ul style="list-style-type: none"> Repeat this process for up to three bar graphs. When finished, use the down arrow key to select the EDIT COMPLETE option and press ENTER to return to the live bar graph screen.

4.7.4. Stack Temperature Hot Spot Screen

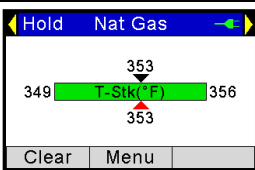
Hot Spot Component	Description
Hot Spot Graph	<ul style="list-style-type: none"> Press RUN/HOLD to start/stop the hot spot function. T-STACK parameter name shown in graph. Limits are determined automatically.  <ul style="list-style-type: none"> Dynamic “current value” pointer indicates real-time value. Color of “current value” pointer is based on limit status: Black (Top): Hottest reading since last “Clear” Red (Bottom): Current reading Ideally, position probe so current reading (bottom) and highest reading (top) match.
Left Arrow	<ul style="list-style-type: none"> Press the LEFT (◀) arrow to go to the Bar Graph Screen.
Right Arrow	<ul style="list-style-type: none"> Press the RIGHT (▶) arrow to go to the main RUN/HOLD Screen.
Clear (F1)	<ul style="list-style-type: none"> Press the F1 button to clear the display and restart if in RUN mode.
Menu (F2)	<ul style="list-style-type: none"> Press the F2 button to return to the Main menu.

4.8. Taking Ambient CO Measurements (Sievert Only)

This procedure takes approximately 15 minutes to complete and provides a minute-by-minute snapshot of CO readings, as well as a “Max CO” value that represents the highest CO reading measured during the entire 15-minute test. Results can be saved to memory, downloaded, and/or printed. Use the following procedure to perform an ambient CO measurement.

Step	Example Procedure for Taking Ambient CO Measurements
1	Turn on the instrument in a fresh air environment and wait for initialization to complete.
2	Verify successful initialization (no errors).

Step	Example Procedure for Taking Ambient CO Measurements
3	If using battery power, check battery status. If battery life is questionable, replace the batteries, as the Ambient CO test takes approximately 15 minutes to complete.
4	Move instrument to target location to be tested.
5	Press F2 to display the Main Menu.
6	Use the down arrow to highlight Ambient CO Test and press the ENTER button.
7	Follow the on-screen instructions to initiate the test.
8	Refer to page 29 for details on navigating the ambient CO test screens, viewing results, saving results to memory, and printing results.

4.9. PC Interface and Fyrite[®] User Software

A PC with Fyrite[®] User Software (FUS) installed can set, edit, and transfer the following:

- instrument time and date
- custom fuels
- test ID
- user name
- customer logo
- instrument setup
- calibration password
- B-SMART[®] code
- test records from the instrument's memory
- firmware updates.



Section 5. Calibration and Maintenance

5.1. Serviceability

The instrument operator is able to easily replace the following components without the use of tools:

- probe assembly
- probe filters
- batteries
- printer paper.

Additionally, a technician, with the use of readily available hand tools and factory-provided instructions, can:

- perform basic diagnostics
- replace sensors
- confirm proper operation

before putting the unit back into service. Field calibration is also possible with the proper equipment. Refer to the calibration section starting on page 86 for more information.

5.2. Cleaning the Probe

The probe tube and gas sample hose will become dirty under normal use.



NOTE: The water trap's filter element should prevent soot from reaching the analyzer's internal components. If the probe is not kept clean, it could become clogged and restrict the flow of gas into the analyzer, resulting in incorrect combustion test readings and calculations.



NOTE: An analyzer that tests natural gas furnaces normally requires less frequent cleaning than an analyzer used for testing coal- or oil-fired furnaces.

5.2.1. Equipment Required

- Alcohol
- Aerosol Can of Automotive Carburetor Cleaner
- Clean Rag
- Source of Compressed Air (optional)



CAUTION: Do not use flammable or combustible substances (like carburetor fluid used for cleaning the probe) near an open flame.

5.2.2. Procedure

Step	Cleaning the Probe
1	Remove gas sample hose from the top of the water trap. <hr/> CAUTION: Carburetor cleaner damages plastic components. Take precautions not to spray cleaner onto the probe handle or analyzer. <hr/>
2	Insert the plastic spray tube of the carburetor cleaner into the gas sample hose, and then liberally spray carburetor cleaner through the hose and out the probe tube.
3	After spraying, remove all the residual cleaner by repeatedly flushing the gas hose and probe tube with alcohol.
4	Wipe off the surfaces of the probe and tubing with a clean cloth.
5	Allow the parts to dry completely. If available, blow compressed air through the probe to expedite the drying process.
6	Reconnect gas sample hose to top of the water trap.

5.3. Water Trap and Filter Replacement

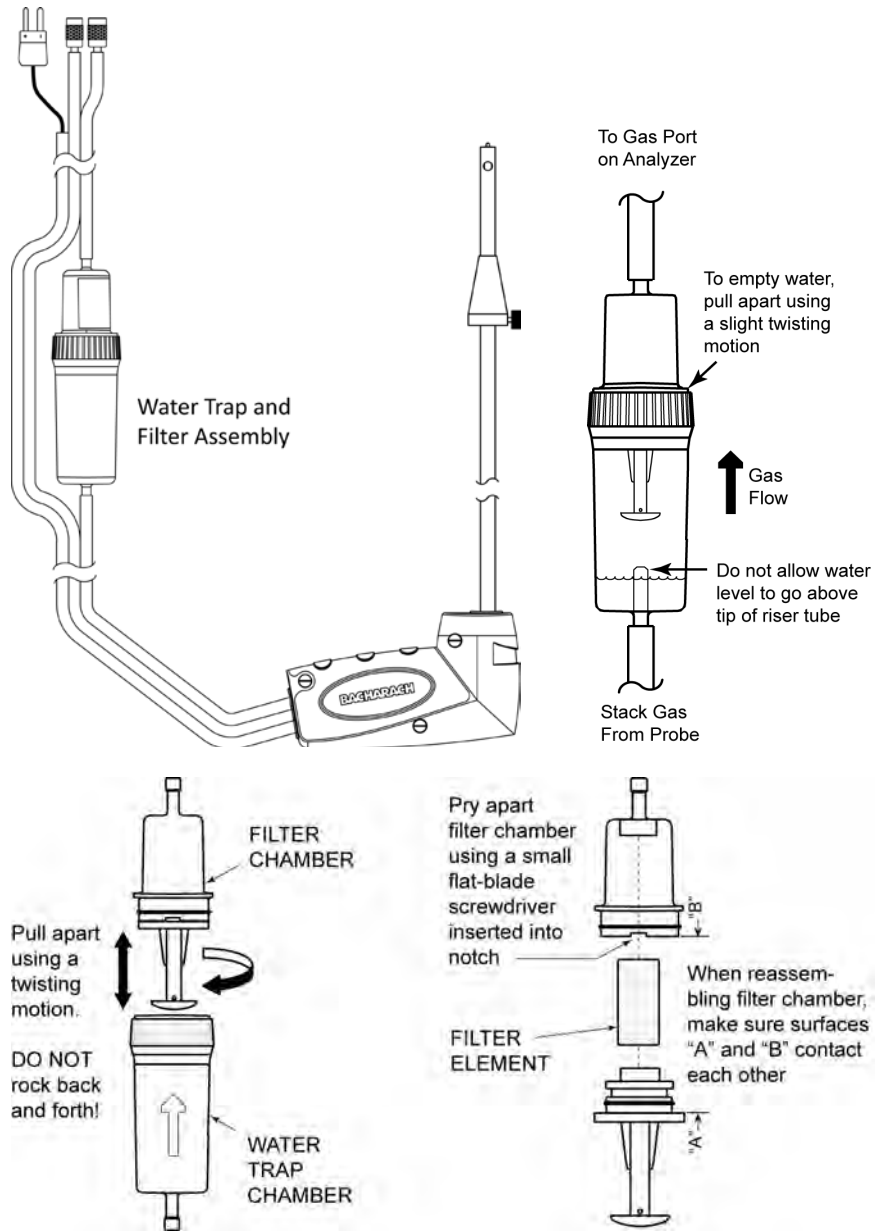

5.4. O₂ and/or CO Sensor Replacement



NOTE: The O₂ sensor life is approximately 2 years. The LL O₂ (long life) sensor life is approximately 3 years. The CO sensor life is greater than 3 years with regular calibration.

5.4.1. Accessing the Sensors

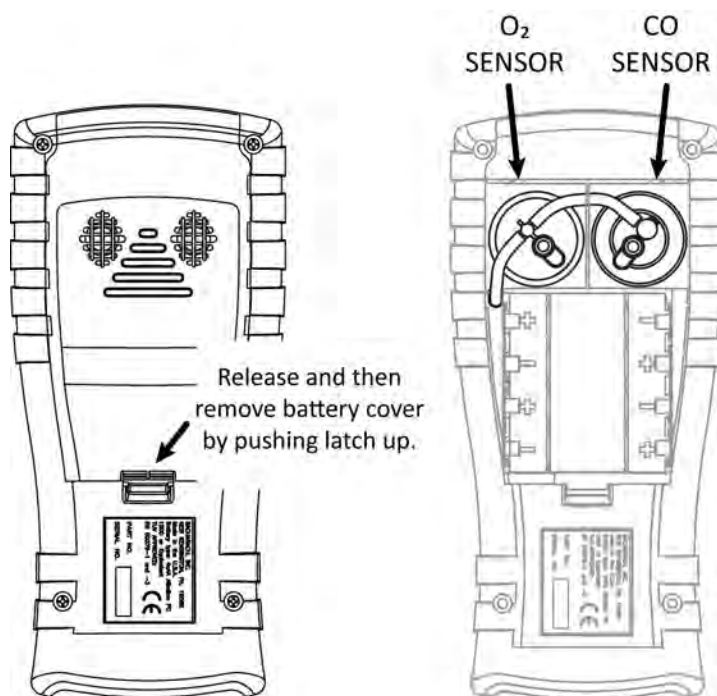

5.4.2. Material Required (As Needed)

- O₂ Sensor (2 year) (P/N 0024-0788) or LL O₂ Sensor (3 year) (0024-1591)
- CO Sensor (P/N 0024-1593) or B-SMART® pre-calibrated sensor (P/N 0024-1616).

5.4.3. O₂ Sensor Replacement Procedure

Follow the procedure below for O₂ and long-life (LL) O₂ sensors. Refer to the illustration on page 84.

Step	O ₂ Sensor Replacement	LL O ₂ Sensor Replacement
1	Remove battery door and connector tubing from both sensors.	Remove battery door and connector tubing from both sensors.
2	Pull O ₂ sensor from its socket.	Remove LL O ₂ cap by twisting counter clockwise.
3	Remove the O ₂ cap.	Gently pull LL O ₂ sensor out of its socket.
4	Properly dispose of the old sensor.	Properly dispose of the old LL O ₂ sensor.
5	Record the 3-digit date code from the new sensor for later use.	Record the 3-digit date code from the new sensor for later use.
6	Engage the nub on the new sensor within the slot on the cap's side and twist to secure the cap and sensor together.	Plug new O ₂ sensor into its socket.
7	Install the cap and sensor unit by: <ul style="list-style-type: none"> Aligning the ribs on the sides of the sensor with the corresponding shape in the base. Inserting the pins into the connectors in the base. 	Install the O ₂ sensor cap by aligning it toward the "open" position (12 o'clock) as shown in the diagram below, then twisting the cap clockwise approximately 40° to the "closed" position (2 o'clock).
8	Reattach tubing.	Reattach tubing.
9	Turn on the unit and enter the 3-digit sensor date code via the Setup Menu selection for "O ₂ Sensor Type" (p 51). Then enter the current date.	Turn on the unit and enter the 3-digit sensor date code via the Setup Menu selection for "O ₂ Sensor Type" (p 51). Then enter the current date.

5.4.4. CO Sensor Replacement Procedure

Follow the procedure below and refer to the illustration on page 84.

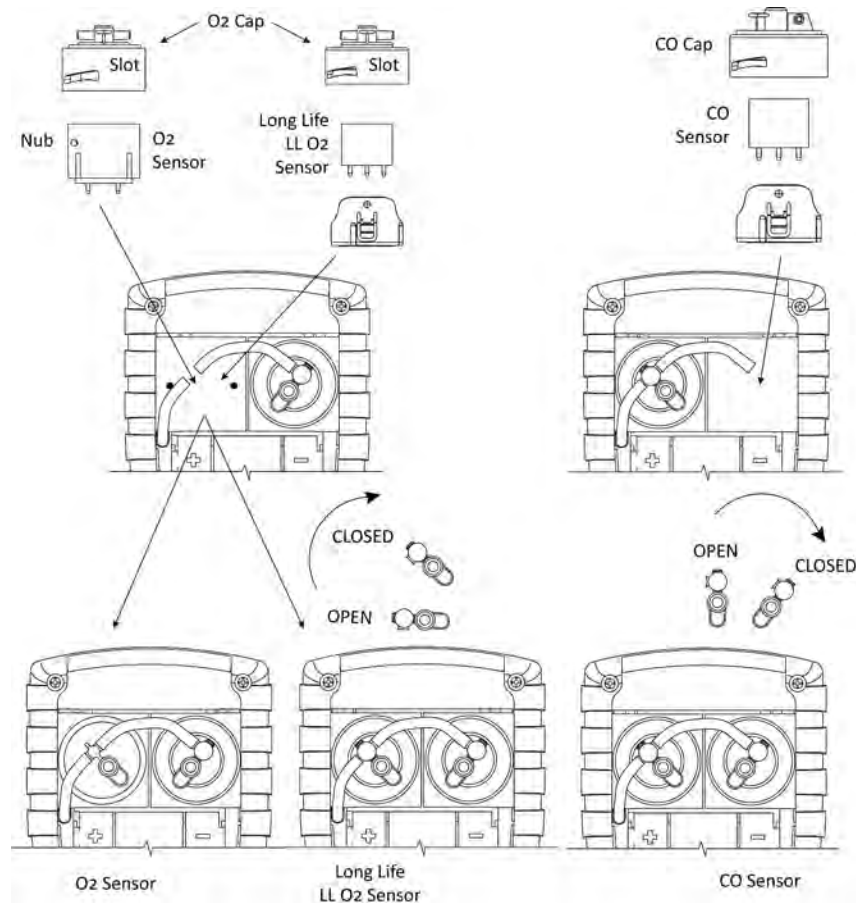

Step	CO Sensor Replacement Procedure
1	Remove battery door and the connector tubing from the CO sensor.
2	Remove CO cap by twisting counter clockwise.
3	Gently pull CO sensor out of its socket.
4	Properly dispose of the old CO sensor.

Step	CO Sensor Replacement Procedure
5	Plug new CO sensor into its socket.
6	Install the CO cap by aligning it toward the "open" position (12 o'clock) as shown in the diagram below, then twisting the cap clockwise approximately 40° to the "closed" position (2 o'clock).
7	Reattach tubing.
8	Calibrate the CO sensor (using the calibration procedure on page 93, or using the B-SMART [®] procedure on page 85).



O₂, LL O₂, and CO Sensor Replacement

5.4.5. B-SMART® CO Sensor Replacement

Step	B-SMART® CO Sensor Replacement
1	Enter the CALIBRATION MENU. Note that this requires password validation (see page 55).
2	Use the UP (▲) and DOWN (▼) arrow buttons to select B-Smart. Press ENTER to display the B-Smart code screen.
3	<p>Use the UP (▲) and DOWN (▼) arrow buttons to enter the 10-digit alphanumeric code supplied with the pre-calibrated B-SMART® sensor. Use the LEFT (◀) and RIGHT (▶) arrow buttons to move the cursor across the screen. Press ENTER.</p> <div style="display: flex; justify-content: space-around; align-items: center;"> <div style="border: 1px solid black; padding: 5px; width: 150px;"> <p style="text-align: center; background-color: #0056b3; color: white; margin: 0;">Calibration Menu</p> <p style="margin: 2px 0;">T-Air</p> <p style="margin: 2px 0;">CO</p> <p style="margin: 2px 0;">T-Ref</p> <p style="margin: 2px 0; background-color: #0056b3; color: white;">B-Smart</p> <p style="text-align: center; margin: 5px 0;">Menu</p> </div> <div style="border: 1px solid black; padding: 5px; width: 150px;"> <p style="text-align: center; background-color: #0056b3; color: white; margin: 0;">B-Smart</p> <p style="text-align: center; margin: 2px 0;">Enter Code</p> <p style="text-align: center; margin: 2px 0;">00-00-00-00-00</p> <p style="text-align: center; margin: 2px 0;">Press ENTER</p> <p style="text-align: center; margin: 5px 0;">Menu</p> </div> </div> <hr/> <p> NOTE: If the correct code was entered, the analyzer accepts it and returns to the CALIBRATION MENU. If an incorrect code was entered, the screen will display "Invalid Code." Check to make sure the correct code has been entered. If problem persists,</p> <hr/> <p> NOTE: B-SMART® codes can be entered through the Fyrite® User Software (FUS).</p>



NOTE: Installing a B-SMART® sensor forces the instrument to perform a zero function (either manual or automatic).



NOTE: Bacharach offers a convenient Exchange Program (where available) that allows the customer to regularly receive pre-calibrated replacement sensors that include a code that can be entered into the analyzer for a quick convenient setup.



5.5. Pressure Sensor Calibration

This procedure calibrates the pressure sensor to a known pressure value.

5.5.1. Materials Required

- Bellows
- Manometer
 - Range: ± 8 in. of water column (± 20 mB)
 - Accuracy: ± 0.01 in. of water column (± 0.025 mB)



5.5.2. Procedure

NOTE: The unit-of-measure for pressure is selected from the Pressure Units parameter in the Setup Menu. In the following procedure “inwc” (inches water column) is selected, but note that any unit-of-measure can be used for calibration purposes. Below are unit conversions for reference.

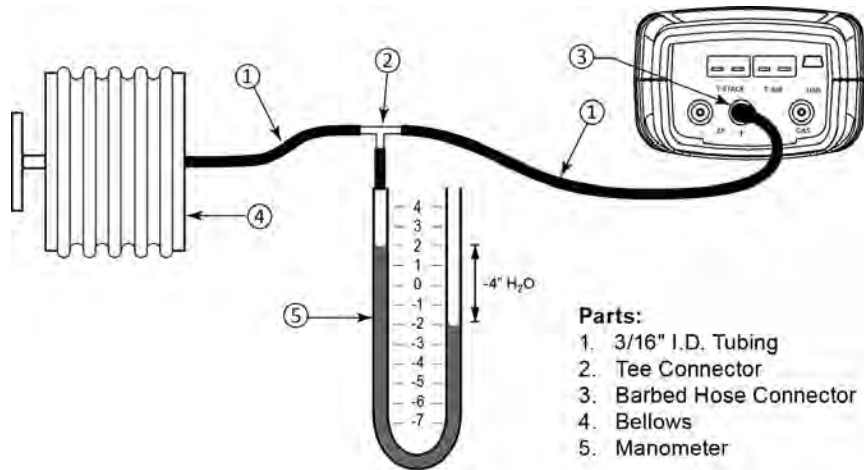

- 249 Pascals/inwc
- 2.49 mB/inwc
- 2.49 hPa/inwc
- 25.4 mm H₂O/inwc

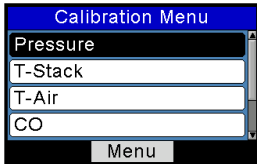
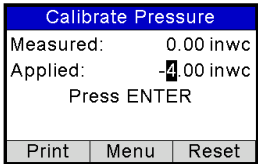

Step	Pressure Sensor Calibration Procedure																		
1	Assemble the pressure sensor calibration equipment as shown above, but DO NOT connect the analyzer to the calibration equipment at this time.																		
2	If not already done, power ON the analyzer and display the CALIBRATION menu. Note that this requires password validation (see page 55).																		
3	Use the UP (▲) and DOWN (▼) arrow buttons to select PRESSURE and then press ENTER to display the CALIBRATE PRESSURE screen. <div style="display: flex; justify-content: space-around; align-items: center;">   </div> <p>"Measured" is the pressure value currently being detected by the pressure sensor, while "Applied" is a known value of pressure that will be applied for calibration purposes.</p>																		
4	With both the -ΔP and +ΔP ports open to the atmosphere, observe that the current measured pressure reading should be 0.00 ± 0.01 inwc. If necessary, zero the pressure sensor (Menu → Pressure → Zero) then repeat steps 2 through 4).																		
5	Connect the hose from the manometer to the +ΔP port and apply a negative pressure to this port by adjusting the bellows for a manometer reading of -4.00 (negative 4.00). Other units are shown below. <table border="1" style="margin-left: auto; margin-right: auto;"> <thead> <tr> <th>Units</th> <th>Name</th> <th>Nominal Calibration Point</th> </tr> </thead> <tbody> <tr> <td>inwc</td> <td>inches water column</td> <td>-4.00 inwc</td> </tr> <tr> <td>mB</td> <td>millibars</td> <td>-10.00 mB</td> </tr> <tr> <td>hPa</td> <td>hecto Pascals</td> <td>-10.00 hPa</td> </tr> <tr> <td>Pa</td> <td>Pascals</td> <td>-1000 Pa</td> </tr> <tr> <td>mm H₂O</td> <td>millimeters of water</td> <td>-101.6 mm H₂O</td> </tr> </tbody> </table>	Units	Name	Nominal Calibration Point	inwc	inches water column	-4.00 inwc	mB	millibars	-10.00 mB	hPa	hecto Pascals	-10.00 hPa	Pa	Pascals	-1000 Pa	mm H ₂ O	millimeters of water	-101.6 mm H ₂ O
Units	Name	Nominal Calibration Point																	
inwc	inches water column	-4.00 inwc																	
mB	millibars	-10.00 mB																	
hPa	hecto Pascals	-10.00 hPa																	
Pa	Pascals	-1000 Pa																	
mm H ₂ O	millimeters of water	-101.6 mm H ₂ O																	
6	Use the UP (▲), DOWN (▼), LEFT (◀), and RIGHT (▶) arrow buttons to enter an "Applied" value that exactly equals the manometer reading. <hr/> <div style="display: flex; align-items: flex-start;">  <p>NOTE: The calibration range is from -6 to -2 inwc (-15 to -5 mB). An attempt to calibrate outside this range will cause the message "Applied Value High" (or Low) to appear at the bottom of the screen.</p> </div> <hr/>																		

Step	Pressure Sensor Calibration Procedure
7	<p>Wait until the Measured reading stabilizes, and then press ENTER to calibrate the pressure sensor's Measured value to that of the Applied value. The message, "Good Calibration" should briefly appear, followed by the CALIBRATION menu.</p> <div data-bbox="722 569 976 730" style="border: 1px solid black; padding: 5px; margin: 10px auto; width: fit-content;"> <p style="background-color: #0056b3; color: white; text-align: center; padding: 2px;">Calibrate Pressure</p> <p style="text-align: center;">Good Calibration</p> <p style="text-align: center;">Entry Saved</p> </div>
8	Remove calibration equipment.

5.6. T-Stack Calibration

This procedure first zeroes and then spans stack temperature to known temperature values.



The use of an electronic thermocouple simulator is the preferred method of producing the desired calibration temperatures. Alternatively, ice and boiling water baths can be used.

5.6.1. Materials Required

- Thermocouple simulator (K-type)
 - Range: 0 to 600° F (-18 to 316° F)
 - Accuracy: ± 0.5° F (± 0.3° C)
- (Alternatively) ice water, boiling water, thermometer

5.6.2. T-Stack Calibration Procedure

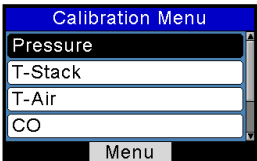
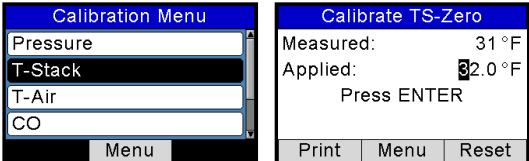
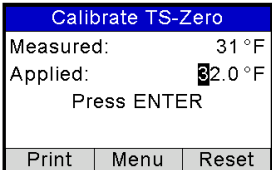
Step	T-STACK Calibration Procedure
1	<p>Plug the simulator into the T-STACK connector located at the bottom of the analyzer.</p> <p>Alternatively: Plug the probe's thermocouple into the T-STACK connector located at the bottom of the analyzer.</p> <hr/> <div style="display: flex; align-items: center;">  <p>IMPORTANT: DO NOT attach the probe's gas hose to the analyzer's GAS port; otherwise water will be drawn into the analyzer!</p> </div> <hr/>

Step	T-STACK Calibration Procedure
2	<p>If not already done, turn ON the analyzer and display the CALIBRATION Menu. Note that this requires password validation (see page 55).</p> 
3	<p>Use the UP (▲) and DOWN (▼) arrow buttons to highlight T-Stack, and then press ENTER to display the CALIBRATE TS-ZERO screen.</p>  <p>"Measured" is the current temperature reading. "Applied" is a known temperature that will be applied for calibration purposes.</p>
4	<p>Set thermocouple simulator to 32° F (0° C), and then use the UP (▲), DOWN (▼), LEFT (◀), and RIGHT (▶) arrow buttons to enter an Applied value that exactly equals the setting of the simulator.</p>  <p>Alternatively: Submerge probe tip into an ice-water bath with a thermometer, wait several minutes, and then use the UP (▲) and DOWN (▼) arrow buttons to enter an Applied value that exactly equals the thermometer reading.</p> <hr/> <p> NOTE: The calibration range is from 32 to 41° F (0 to 5° C). An attempt to calibrate outside this range will cause the message "Applied Value High" (or Low) to appear at the bottom of the screen.</p>
5	<p>Wait until the Measured reading stabilizes, and then press ENTER to calibrate the TS-Zero Measured value to that of the Applied value, after which the message "Good Calibration" should briefly appear followed by the CALIBRATE TS-SPAN screen.</p>

Step	T-STACK Calibration Procedure
6	<p>Set thermocouple simulator to 572° F (300° C), and then use the UP (▲), DOWN (▼), LEFT (◀), and RIGHT (▶) arrow buttons to enter an Applied value that exactly equals the setting of the simulator.</p> <p>Alternatively: Submerge probe tip into a container of boiling water with a thermometer, wait several minutes, and then use the arrow buttons to enter an Applied value that exactly equals the thermometer reading.</p> <div data-bbox="712 636 984 806" style="border: 1px solid black; padding: 5px; margin: 10px auto; width: fit-content;"> <p style="text-align: center; background-color: #000080; color: white; margin: 0;">Calibrate TS-Span</p> <p>Measured: 570 °F</p> <p>Applied: 572 °F</p> <p style="text-align: center;">Press ENTER</p> <div style="display: flex; justify-content: space-around; margin-top: 5px;"> Print Menu Reset </div> </div> <p> NOTE: The calibration range is from 175 to 625° F (79 to 329° C). An attempt to calibrate outside this range will cause the message “Applied Value High” (or Low) to appear at the bottom of the screen.</p>
7	<p>Wait until the Measured reading stabilizes, and then press ENTER to calibrate the TS-Span Measured value to that of the “Applied” value, after which the message “Good Calibration” should briefly appear followed by the CALIBRATION screen being re-displayed.</p>

5.7. T-Air Calibration



This procedure first zeros and then spans T-AIR temperature to known temperature values.



The use of an electronic thermocouple simulator is the preferred method of producing the desired calibration temperatures. Alternatively, containers of ice water and boiling water can be used.

5.7.1. Materials Required

- Thermocouple Simulator (K-type)
 - Range: 0 to 600° F (-18 to 316° F)
 - Accuracy: ± 0.5° F (± 0.3° C)
- (Alternatively) Ice Water, Boiling Water, Thermometer

5.7.2. T-Air Calibration Procedure

Step	T-Air Calibration Procedure
1	<p>Plug the simulator into the T-AIR connector located at the bottom of the analyzer.</p> <p>Alternatively: Plug the probe's thermocouple into the T-AIR connector located at the bottom of the instrument.</p> <hr/> <p> IMPORTANT: DO NOT attach the probe's gas hose to the analyzer's GAS port, otherwise water will be drawn into the analyzer!</p>
2	<p>If not already done, turn ON the analyzer and display the CALIBRATION MENU. Note that this requires password validation (see page 55).</p> <div data-bbox="971 779 1226 940" style="border: 1px solid black; padding: 5px;"> <p style="text-align: center; background-color: #0056b3; color: white; margin: 0;">Calibration Menu</p> <p>Pressure</p> <p>T-Stack</p> <p>T-Air</p> <p>CO</p> <p style="text-align: center; background-color: #ccc; margin: 0;">Menu</p> </div>
3	<p>Use the UP (▲) and DOWN (▼) buttons to highlight T-Air, and then press ENTER to display the CALIBRATE TA-ZERO screen.</p> <div data-bbox="586 1020 841 1182" style="border: 1px solid black; padding: 5px; display: inline-block;"> <p style="text-align: center; background-color: #0056b3; color: white; margin: 0;">Calibration Menu</p> <p>Pressure</p> <p>T-Stack</p> <p style="background-color: #0056b3; color: white;">T-Air</p> <p>CO</p> <p style="text-align: center; background-color: #ccc; margin: 0;">Menu</p> </div> <div data-bbox="857 1020 1112 1182" style="border: 1px solid black; padding: 5px; display: inline-block; margin-left: 20px;"> <p style="text-align: center; background-color: #0056b3; color: white; margin: 0;">Calibrate TA-Zero</p> <p>Measured: 30.4 °F</p> <p>Applied: 32.0 °F</p> <p style="text-align: center;">Press ENTER</p> <p style="text-align: center; background-color: #ccc; margin: 0;">Print Menu Reset</p> </div> <hr/> <p> NOTE: "Measured" is the current temperature reading, while "Applied" is a known temperature that will be applied for calibration purposes.</p>
4	<p>Set thermocouple simulator to 32° F (0° C), and then use the UP (▲), DOWN (▼), LEFT (◀), and RIGHT (▶) arrow buttons to enter an applied value that exactly equals the setting of the simulator.</p> <div data-bbox="971 1388 1226 1549" style="border: 1px solid black; padding: 5px;"> <p style="text-align: center; background-color: #0056b3; color: white; margin: 0;">Calibrate TA-Zero</p> <p>Measured: 30.4 °F</p> <p>Applied: 32.0 °F</p> <p style="text-align: center;">Press ENTER</p> <p style="text-align: center; background-color: #ccc; margin: 0;">Print Menu Reset</p> </div> <p>Alternatively: Submerge probe tip into an ice-water bath with a thermometer, wait several minutes, and then use the UP (▲), DOWN (▼), LEFT (◀), and RIGHT (▶) arrow buttons to enter an applied value that exactly equals the thermometer reading.</p>

Step	T-Air Calibration Procedure
	<div style="border: 1px solid black; padding: 5px;">  <p>NOTE: The calibration range is from 32 to 41° F (0 to 5° C). An attempt to calibrate outside this range will cause the message “Applied Value High” (or Low) to appear at the bottom of the screen.</p> </div>
5	<p>Wait until the measured reading stabilizes, and then press ENTER to calibrate the TA-Zero Measured value to that of the applied value, after which the message “Good Calibration” should briefly appear followed by the CALIBRATE TA-SPAN screen.</p> <div style="display: flex; justify-content: space-around; align-items: flex-start;"> <div style="border: 1px solid black; padding: 5px; width: 45%;"> <p style="text-align: center; background-color: #000080; color: white; margin: 0;">Calibration Menu</p> <p>Pressure</p> <p>T-Stack</p> <p style="background-color: #000080; color: white; margin: 0;">T-Air</p> <p>CO</p> <p style="text-align: center; background-color: #cccccc; margin: 0;">Menu</p> </div> <div style="border: 1px solid black; padding: 5px; width: 45%;"> <p style="text-align: center; background-color: #000080; color: white; margin: 0;">Calibrate TA-Zero</p> <p>Measured: 30.4 °F</p> <p>Applied: 32.0 °F</p> <p style="text-align: center;">Press ENTER</p> <p style="text-align: center; background-color: #cccccc; margin: 0;">Print Menu Reset</p> </div> </div>
6	<p>Set thermocouple simulator to 212° F (100° C), and then use the UP (▲), DOWN (▼), LEFT (◀), and RIGHT (▶) arrow buttons to enter an applied value that exactly equals the setting of the simulator.</p> <div style="border: 1px solid black; padding: 5px; margin: 10px auto; width: 150px;"> <p style="text-align: center; background-color: #000080; color: white; margin: 0;">Calibrate TA-Span</p> <p>Measured: 210.3 °F</p> <p>Applied: 212 °F</p> <p style="text-align: center;">Press ENTER</p> <p style="text-align: center; background-color: #cccccc; margin: 0;">Print Menu Reset</p> </div> <p>Alternatively: Submerge probe tip into a container of boiling water with a thermometer, wait several minutes, and then use the UP (▲), DOWN (▼), LEFT (◀), and RIGHT (▶) arrow buttons to enter an applied value that exactly equals the thermometer reading.</p> <div style="border: 1px solid black; padding: 5px; margin-top: 10px;">  <p>NOTE: The calibration range is from 194 to 230° F (90 to 110° C). An attempt to calibrate outside this range will cause the message “Bad Calibration Wrong CAL Entry” to appear in the following step.</p> </div>
7	<p>Wait until the measured reading stabilizes, and then press ENTER to calibrate the TA-Span Measured value to that of the applied value, after which the message “Good Calibration” should briefly appear followed by the CALIBRATION MENU screen being re-displayed.</p>

5.8. CO Sensor Calibration

5.8.1. Materials Required



- Calibration kit, P/N 0024-7059
- Gas cylinder: 500 ppm CO in air, P/N 0024-0492

5.8.2. CO Manual Zero Procedure

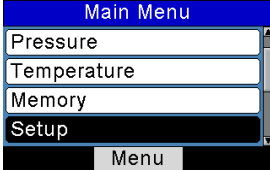
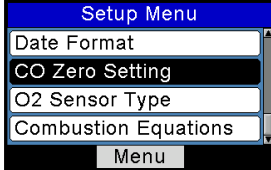
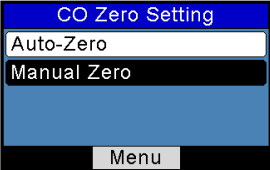
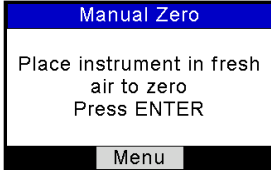
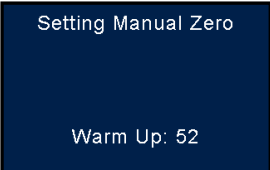
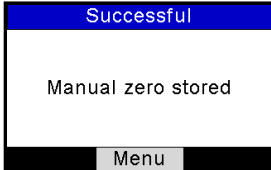
The CO zeroing process is done automatically during warmup or manually using the manual zero feature. To perform a manual zero, follow the steps below. If your instrument is configured for CO auto mode, skip this CO manual zero procedure and go to the CO Sensor Span procedure that follows.

Step	Manual CO Zero Procedure
1	If not already done, turn ON the analyzer and display the Main Menu screen.
2	Use the UP (▲) and DOWN (▼) arrow buttons to select the SETUP menu and press ENTER.
3	From the Setup Menu, use the UP (▲) and DOWN (▼) arrow buttons to select the CO Zero Setting parameter then press ENTER. <div style="display: flex; justify-content: space-around; margin-top: 10px;">   </div>
4	From the CO Zero Setting screen, use the DOWN (▼) arrow button to select the Manual Zero option then press ENTER. A reminder screen to place the instrument in fresh air is displayed. <div style="display: flex; justify-content: space-around; margin-top: 10px;">   </div>
5	Press ENTER and wait for the manual zero to complete. <div style="display: flex; justify-content: space-around; margin-top: 10px;">   </div>

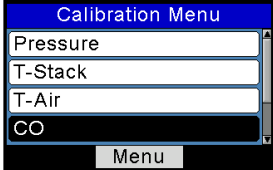
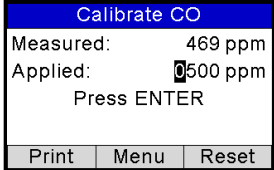
5.8.3. CO Sensor Span Procedure

Step	CO Span Procedure
1	<p>From the Calibration Menu, use the UP (▲) and DOWN (▼) arrow buttons to highlight CO, and then press ENTER to display the CALIBRATE CO screen. Note that this requires password validation (see page 55).</p> <div style="display: flex; justify-content: space-around;">   </div> <p>“Measured” is the current CO reading, while “Applied” is a known CO level that will be applied for calibration purposes.</p>
2	<p>Use the UP (▲), DOWN (▼), LEFT (◀), and RIGHT (▶) arrow buttons to enter an Applied value that exactly equals the concentration stamped on the CO cylinder.</p> <hr/> <p> NOTE: Bacharach recommends using a 500 ppm calibration gas, however the calibration range is from 20 to 1,000 ppm. An attempt to calibrate outside this range will cause the message “Applied Value High” (or Low) to appear at the bottom of the screen.</p> <hr/>
3	<p>Attach a 500 ppm CO cylinder to the regulator and connect calibration kit components as shown below. Apply 500 ppm carbon monoxide in an air balance calibration gas.</p>
4	<p>Wait until the Measured reading stabilizes and then press ENTER. The message “Good Calibration” should briefly appear.</p> <p>If the sensor’s output is low, but still usable, then the message “Good Calibration WARNING Low Sensor” will appear. The sensor will now be marked as being Low in the Warm up screen.</p> <p>If the sensor’s output is too low to be usable, then the message “Bad Calibration Sensor End of Life, Entry Not Saved” will appear.</p>
5	<p>Close the regulator and remove the CO cylinder.</p>

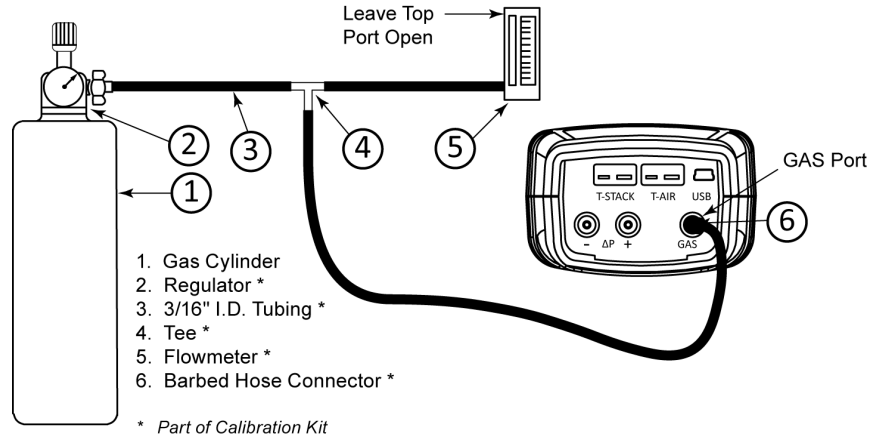

5.9. T-Ref Sensor Calibration

The T-Ref sensor is located inside the instrument. Calibration is done at the factory and should not need to be done in the field.



Section 6. Troubleshooting

6.1. Error and Warning Messages

Message	Description
T-STK Disconnected	The probe thermocouple is not connected to the analyzers T-Stack connector. Plug the probe thermocouple plug into the T-Stack connector at the bottom of the instrument.
Check Sensor O ₂	O ₂ sensor output is low, but still usable. Sensor may need to be replaced in the near future. The arrow on the O ₂ Sensor Life screen is in the “replace” segment. Refer to page 56. 
Replace Sensor O ₂	O ₂ sensor output is low and should be replaced. The arrow on the O ₂ Sensor Life screen is beyond the bar graph (typically 2 years for standard O ₂ sensors and 3 years for long-life O ₂ sensors). Refer to page 56.
Bad Sensor O ₂	O ₂ sensor output is too low and is not usable.
Low Sensor CO	CO sensor output was low but still usable. Sensor may need to be replaced in the near future.
Low Battery	Battery voltage is low. Replace the batteries.
Applied Value High/Low	An attempt was made to calibrate a sensor outside its range—either above (High) or below (Low) the acceptable range.
Warmup Sensor Error	<ul style="list-style-type: none"> CO sensor was not zeroed at warmup because of high output. Run instrument on fresh air then restart instrument to re-zero sensor. If the message persists, the CO sensor may need to be replaced. Stack or Air temperature sensors are measuring temperature outside the range of -4° to 212° F at warmup. Make sure that the Stack and Air thermocouples are sampling ambient room air within the temperature range at warmup. The Fyrite[®] INSIGHT[®] Plus was turned on with the probe sampling flue gas. Move the probe to fresh air and restart the instrument. Messages will indicate which sensors are in error.

Message	Description
Set Clock	<p>Time and date values need to be set in the instrument.</p> <hr/> <p> NOTE: If a “set clock” message occurs, then the instrument ignores CO calibration reminder messages and all O₂-related messages <i>except</i> “Bad Sensor.”</p> <hr/>
Cal Reminder ## months	The calibration reminder occurs during warmup and is based on the CO calibration reminder setting (see page 47), the current date setting (see 36), and the date of the last calibration of the CO sensor.
X X X	Occurs in the number fields of sensors that have achieved over-range condition.
* * *	Occurs in the number fields of sensors. Replaces in-error sensor values and any calculated values that depend on those sensor values.
- - -	Occurs in the number fields of sensors and indicates that values were not calculated.



NOTE: If a particular sensor is in error during warmup, the instrument automatically displays the error. The instrument continues to operate with the sensor in error, however information dependent on the sensor in error is not displayed.

6.2. Replacement Parts

Part Number	Description
0204-0004	Battery, AA alkaline
0024-1453	Battery door/sensor cover
0024-1461	Boot , rubber
0024-1616	B-SMART® CO sensor w/ NOx filter
0024-0865	Carry case (hard)
0024-1587	CO sensor cap (includes gasket)
0024-1593	CO sensor w/ NOx filter
0024-1585	End plate (includes O rings)
0007-1644	Filters, pkg. of 3
0024-9487	Instruction manual
0024-1591	LL O ₂ sensor
0024-1586	LL O ₂ sensor cap (includes gasket)
0024-1471	O ring kit
0024-0788	O ₂ sensor
0024-1421	O ₂ sensor cap (includes gasket)
0024-1310	Printer paper, box of 5 rolls
0024-3004	Probe and hose assembly (North America)
0024-3053	Probe and hose assembly (Siegert)
0019-3037	Probe stop
0024-3073	Pump assembly
0024-1583	Sensor adapter
0104-1798	Thermocouple (temperature, air), K type (1 inch long)
0104-1797	Thermocouple (temperature, stack), K-type (10 feet long)
0019-3265	Water trap

6.3. Accessories

Part Number	Standard Accessory
0024-8242	Δ P (pressure) and Δ T (temperature) Kit
0024-8259	Δ P (pressure) Kit
0024-8258	Δ T (temperature) Kit
0024-1611	AC adapter, USB assembly
0024-7059	Calibration kit (no gas)
0051-1994	CO calibration gas, 100 ppm CO
0024-0492	CO calibration gas, 500 ppm CO
0024-1470	FUS installer CD (Std for some part numbers)
0024-1400	IrDA printer
0024-8257	LL O ₂ Sensor Upgrade kit
0024-1310	Printer paper, box of 5 rolls
0024-1492	Reporting kit (USB cable, IrDA printer, and FUS)
0021-7006	Tru Spot [®] Smoke kit
0104-4032	USB cable (standard for some part numbers)
0024-8555	Optional Appliance Kit for Ambient CO Test

6.4. Instrument Identification

A label on the back of the instrument provides the following information that is useful for service and troubleshooting.

- manufacturer
- country of origin
- certification(s)
- part number
- serial number

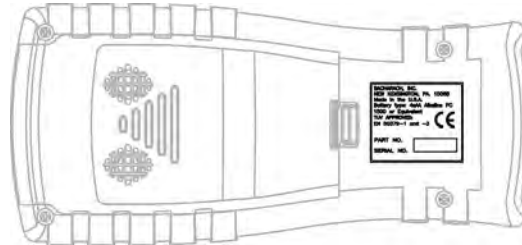

Siegert Label





CE Declaration of Conformity

The manufacturer of the products covered by this declaration:	
Year conformity is declared:	2012
Product(s):	Combustion Analyzer
Model(s):	Fyrite [®] INSIGHT [®] Plus

The undersigned hereby declares that the above referenced product is in conformity with the provisions of the following standards and is in accordance with the following directive.

Directive:

2004/108/EC	EMC Directive
-------------	---------------

Standard(s):

EN 50270: 2006	Electromagnetic Compatibility (Immunity): Electrical Apparatus for the Detection and Measurement of Combustible Gases, Toxic Gases, or Oxygen
EN 50379-1 Part 1	General Requirements and Test Methods: Specifications for Portable Electrical Apparatus Designed to Measure Combustion Flue Gas Parameters of Heating Appliances
EN 50379-3 Part 3	Performance Requirements: Performance Requirements for Apparatus Used in Non-Statutory Servicing of Gas-Fired Heating Appliances

Signature: 
Name: Doug Keeports
Title: VP of Product Development
Date: 25 July 2012

The technical documentation file required by this directive is maintained at the corporate headquarters of Bacharach, Inc.